

orasgroup



ORAS Ltd.  
Isometsäntie 2, P.O. Box 40  
FI-26101 Rauma  
Finland

Tel. +358 2 83 161  
Fax +358 2 831 6300  
info.finland@oras.com  
www.oras.com

HANSA Armaturen GmbH  
P. O. BOX 81 02 40  
D-70519 Stuttgart  
Sigmaringer Strasse 107  
D-70567 Stuttgart  
Tel.: +49 711 16 14 0  
Fax: +49 711 16 14 368  
info@hansa.de  
www.hansa.com

943448-11-23

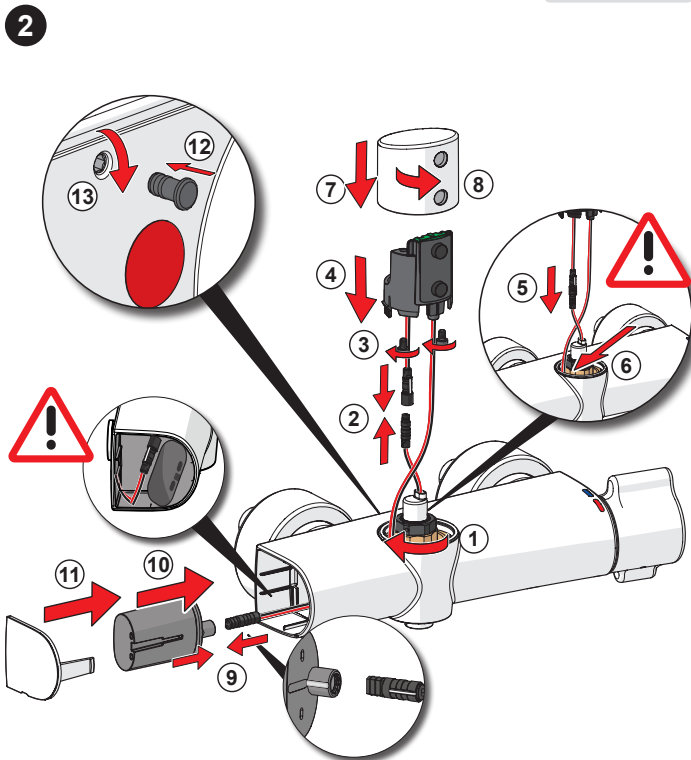
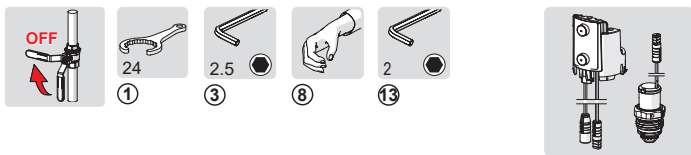

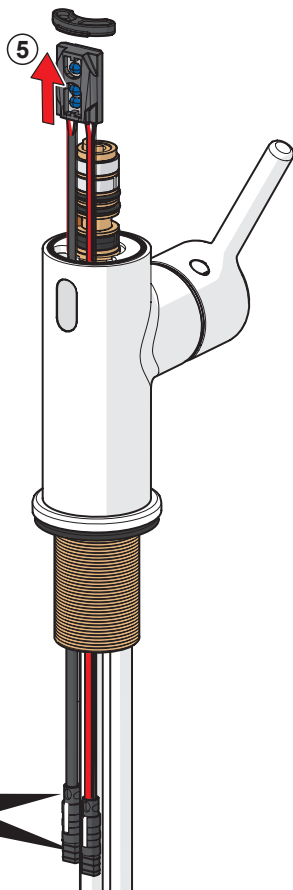
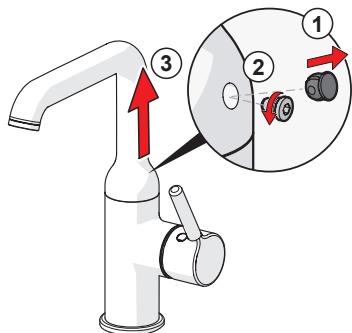
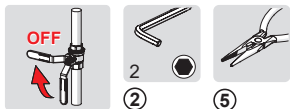

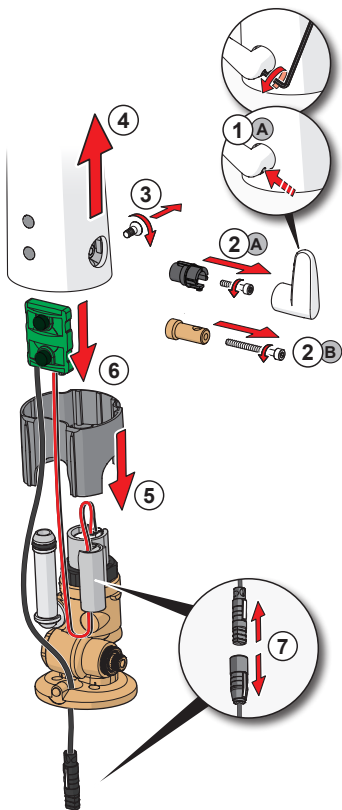
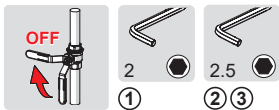

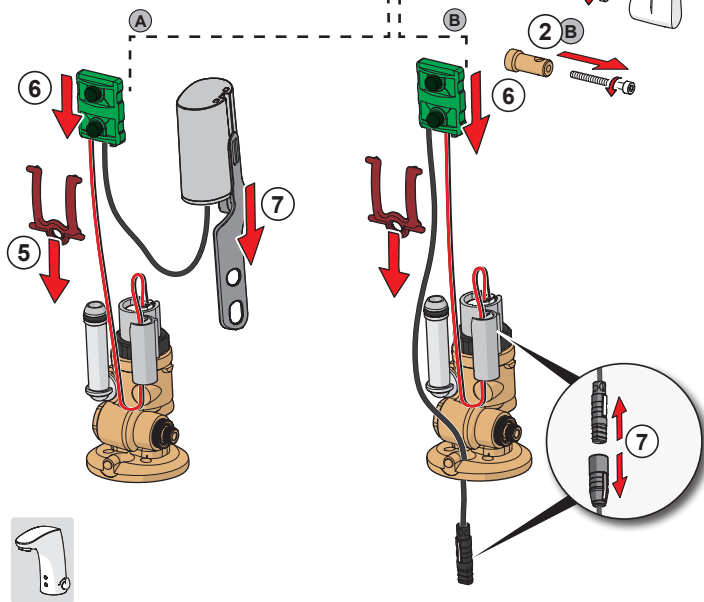
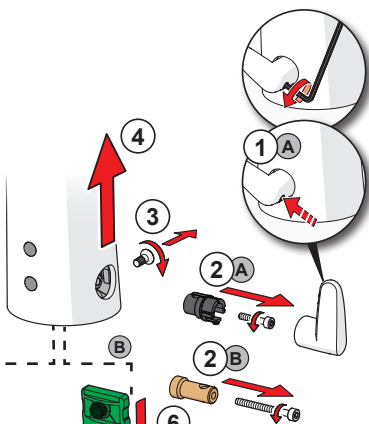
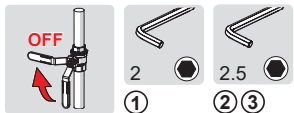

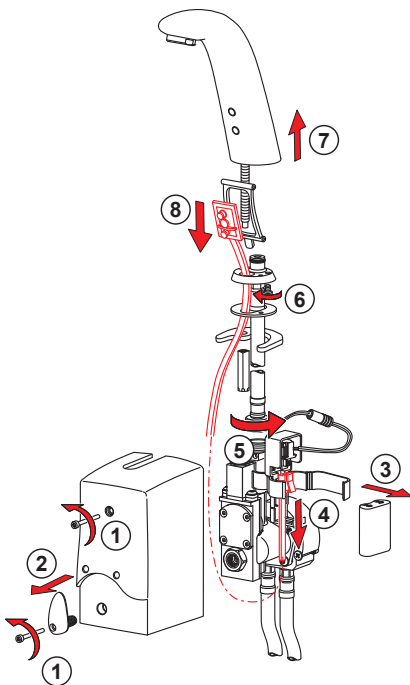
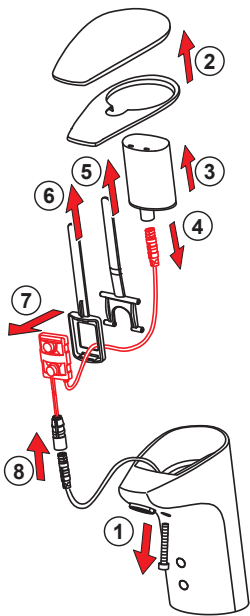
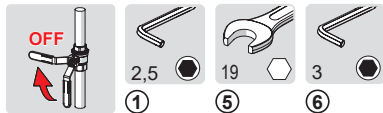
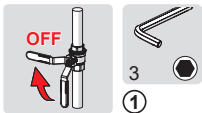

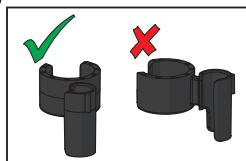
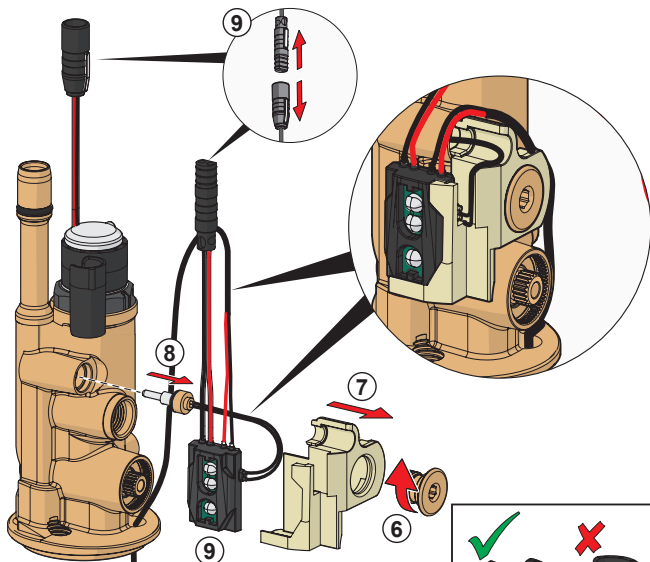
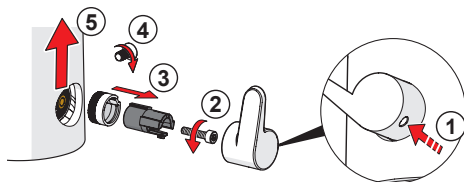
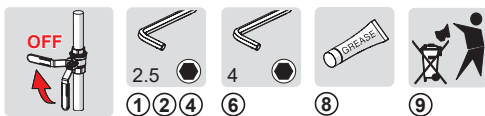

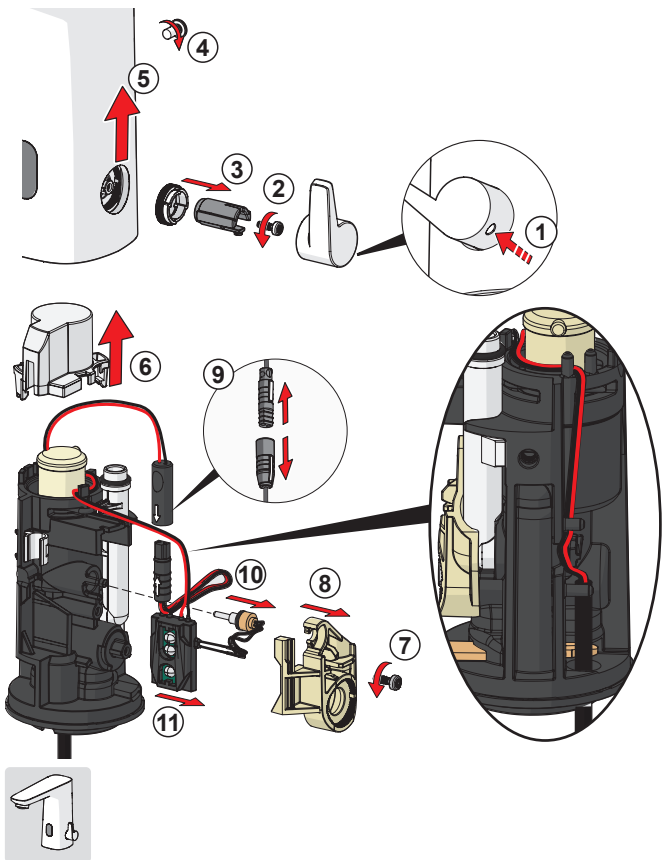
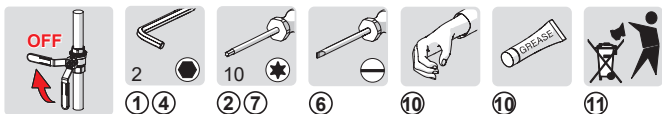



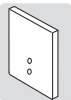
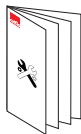

[static.oras.com/manual/6507CZ](http://static.oras.com/manual/6507CZ)



[static.oras.com/manual/6188Z](http://static.oras.com/manual/6188Z)



[static.oras.com/manual/6567Z](http://static.oras.com/manual/6567Z)



[static.oras.com/manual/2227F](http://static.oras.com/manual/2227F)



[static.oras.com/manual/2216F](http://static.oras.com/manual/2216F)

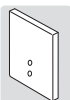

[static.hansa.com/manual/09469179](http://static.hansa.com/manual/09469179)



[static.hansa.com/manual/00870019](http://static.hansa.com/manual/00870019)



[static.hansa.com/manual/09440179](http://static.hansa.com/manual/09440179)



[static.hansa.com/manual/55712203](http://static.hansa.com/manual/55712203)



[static.hansa.com/manual/55112201](http://static.hansa.com/manual/55112201)

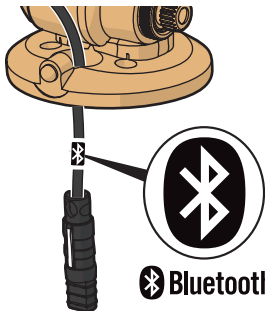

Oras App



[apps.oras.com](https://apps.oras.com)



HANSA Connect App



[hansa.com/hansa-app](https://hansa.com/hansa-app)



Apple and the Apple logo are trademarks of Apple Inc., registered in the U.S. and other countries. App Store is a service mark of Apple Inc., registered in the U.S. and other countries.

Google Play and the Google Play logo are trademarks of Google Inc.

The Bluetooth® word mark and logos are registered trademarks owned by the Bluetooth SIG, Inc. and any use of such marks by Oras Group is under license. Other trademarks and trade names are those of their respective owners.