



YANMAR

MIDI EXCAVATOR

B7-6



Operating weight	8,200 kg
Engine	4TNV98C-WBV2
Digging force (arm)	40,6 kN
Digging force (bucket)	56,9 kN

A breakthrough in the ultra-tight turning



COMPACTNESS

The B7 Sigma-6 is the most compact excavator in the 8-10 tons with a complete swing radius of 1320 mm, which is 34% less than comparable machines with articulated boom. It offers the possibility to the operator to turn 360° in a traffic lane of 2,7 meters.



UNIQUE BOOM CONCEPT

The Yanmar Sigma Boom is a three piece offset boom which offers the smallest turning radius, an increased lifting performance, and an optimal visibility on the working zone for the operator.



POWERFUL YANMAR ENGINE

The B7 Sigma-6 uses the newest version (Y-Harmonizer) of the Yanmar TNV engines. It is a Yanmar 4-cylinder engine with direct injection and common rail system. This engine is also equipped with a cooled EGR and a DPF, which allow the machine to exceed EU emission regulations and to meet already the next EU Stage V level.



BEST COMPONENTS

Developed in Japan with renowned components for top quality. Design and performance of the components are made for heavy-duty job sites and long service life.



EASE OF MAINTENANCE

Simple maintenance structure for fast and easy access to all components. Facilitated daily checks.



concept of the excavators



CABIN

The last generation of the B7 Sigma-6 received a lot of attention for the development of the operator station with radical changes. Yanmar developed a new cabin with an increased space for the operator by 40%.



EASY OPERATION

Ideally located, the control levers offer exceptional movement precision. Double adjustable proportional control of both auxiliary circuits.



HIGH PERFORMANCE

Efficiency beyond your ultra-tight turning machine. Features of a large excavator in a compact format to carry out heavy-duty jobs.



EXCELLENT STABILITY

The robust X-frame design of the undercarriage, the patented VICTAS asymmetric crawlers, the special boom configuration provide the B7 Sigma-6 with an impressive level of stability especially on the side.

UNMATCHED COMPACTNESS

WHEN WORKING AT BOOM OFFSET IN NARROW TRENCHES, THE SECOND PART OF THE BOOM DOES NOT STRIKE THE LEFT-HAND SHORING PLATE, AS TENDS TO OCCUR WITH TRADITIONAL EXCAVATORS.



- + True Zero Tail Swing excavator
- + Smallest front turning radius of the industry with only 1320 mm.
- + Ideal worktool for jobsites in densely populated areas and urban sites with limited space.

This outstanding compactness has three major merits:

- + Increasing the efficiency and productivity of the machine.
- + Having a lower impact on traffic congestion.
- + Improved safety for the operator.

UNIQUE BOOM CONCEPT

Yanmar developed for the B7-6 a unique boom concept. It offers a three piece offset boom, made out of high tensile steel, which is 1,5 times stronger than normal steel.

The Sigma boom has several big advantages due to the specific cinematic, it offers the best dumping height - digging height in its class, combined with extraordinary digging depth.



VISIBILITY

The Sigma boom offers at the same time the best visibility on the attachment and the working area of the industry. This reduces greatly the stress for the operator and improves at the same time safety and productivity.

FLEXIBILITY

The dipperstick and attachment can even get under an obstacle, because of the flexibility of the cinematic.

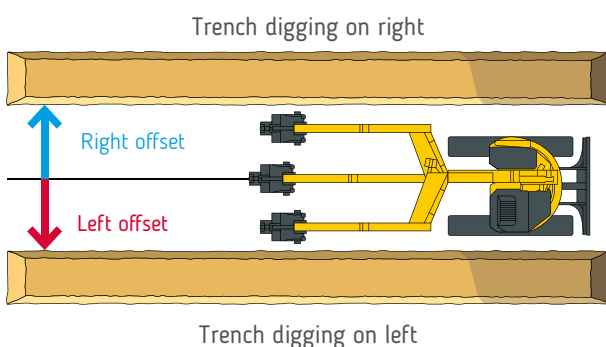

PRODUCTIVITY

The second articulation of the boom provides the offset on lateral movement of the workgroup and attachment without rotation of the upper frame. This offers enormous gain in productivity and visibility for the operator.

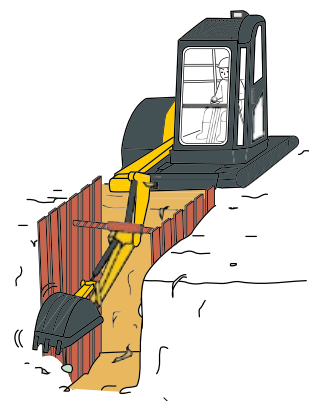



MAXIMUM STABILITY AND EXCEPTIONAL LIFTING STRENGTH

The B7 Sigma-6 has an exceptional stability due to its unique boom design, since the pivot point of the boom is located close to the center of gravity of the machine. Therefore, the B7-6 is the optimal tool to lift and place loads.

Furthermore, the B7-6 is equipped with the patented VICTAS system. This unique track system proposing an offset rolling path enables the excavator to lift loads with increased performance while having the most compact size in its class.

UNIQUE UNDERCARRIAGE

The X-shaped, box-section structure of the undercarriage provides excellent resistance to torsional bending. The frame is designed for maximum durability.

The VICTAS system, patented by Yanmar, offers additional advantages like an increased tracking through the use of an asymmetric pattern, which reduces vibration, noise level and therefore improves the operator comfort. The increased support surface reduces track degradation and improves service life.



PERFORMANCE

POWERFUL YANMAR ENGINE

The B7 Sigma-6 benefits from the most advanced technology of the leading manufacturer of industrial diesel engines. The 53,5 HP TNV engine is equipped with direct injection to create clean burning power. It has fully-electronic control to provide the B7 Sigma-6 with total intelligent engine control. The engine is also equipped with a common rail system to allow fine-tuned electronic control of fuel injection.



ELECTRICAL CONTROL SYSTEM EGR AND DPF

The Yanmar engine is already fully compliant with EU Stage V requirement, meaning that our engine has cleaner emission than required today. This is achieved through two additional features.

The first is the cooled EGR (Exhaust Gas Recirculation) which reduces drastically the nitrogen oxides (NOx).

The second is the DPF (Diesel Particulate Filter) to clean up exhaust emissions (PM). Yanmar has successfully developed an exclusive regeneration system in order to combat clogging and cleaning down-time.



VIPPS HYDRAULIC CIRCUIT (VIO PROGRESSIVE 3 PUMP SYSTEM)

The B7 Sigma-6 is equipped with a hydraulic circuit with aggregated power regulation equipped with three variable flow piston pumps and a multiple combination directional control valve. Pumps engage automatically depending on the operation being performed, providing greater ease of use for the operator. On one hand, the combination of the pump flows can increase the work speed and on the other hand, the system allows smooth and simultaneous performance of all the operations, even while travel.

ADJUSTABLE PROPORTIONAL CONTROL OF THE AUXILIARY CIRCUITS

The B7 Sigma-6 is standard equipped with two auxiliary hydraulic circuits. Both are operated via a proportional control located on the joystick which adapt the flow and the direction of the oil flow. Additionally each circuit has an easy to operate potentiometer to adjust the oil flow to the optimal requirement for each and every attachment.

COMFORT

SPACIOUS AND COMFORTABLE CAB

Yanmar has been paying a lot of attention to the operator station with this ultimate version of the B7 Sigma-6. We have considerably increased the space inside the cabin by increasing the width and the length of the cabin. As a result the cabin offers 40% more space to the operator for an improved comfort.

COMFORTABLE ADJUSTABLE SEAT

The interior of the cabin has been completely redesigned and developed with a lot of care, bearing in mind that the operator comfort has a direct impact on his productivity. The seating position has numerous possibilities of adjustments. The air suspension seat is standard and can be adjusted alone or simultaneously with the consoles like in big excavators. This allows the operator to find his optimal working position.

SILENT CABIN

The Yanmar engineers have put a lot of emphasis on innovative ways to reduce the noise level. This investment has a huge impact on the comfort level of the operator.



DIGITAL INTERFACE

The B7 Sigma-6 is equipped with the newest digital interface that informs the operator in real time about the status of his machine. Perfectly integrated into the right-hand console, the 3.3" screen provides excellent visibility.

The interface provides the customer with useful information through LED lamps, or indications about important elements like fuel consumption, fuel gauge, coolant temperature gauge, etc...

The interface assists also the customer for maintenance intervals and to program such interventions.

The interface works also as a diagnostic tool in case of malfunction by sending an error code and an information icon on the display.

The machine is also provided with an economy mode, and the auto-idle function as standard equipment.

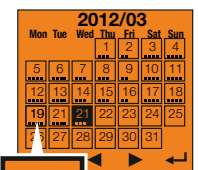
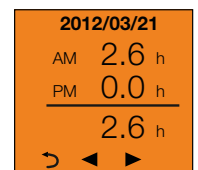
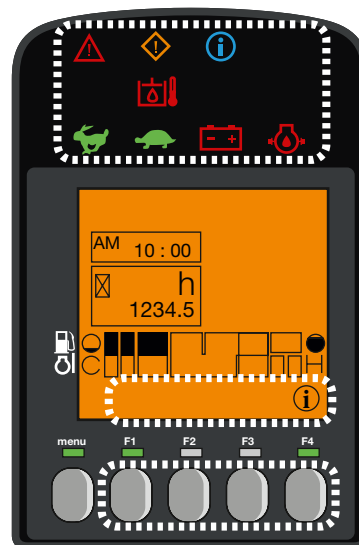

IMPROVED AIR CONDITIONING

The B7 Sigma-6 air conditioning performance has been greatly improved through increase of the cooling performance of the unit, and increase of the ventilation performance. The cooled air distribution and circulation in the cabin has been revised and improved through the optimal location of six vents. The defrost function ensures perfect demisting of the cabin.

These changes improve greatly the operator comfort, especially in hot weather conditions.

ALL-AROUND VISIBILITY

The B7 Sigma-6 design provides an ergonomic environment, excellent visibility and exceptional safety. The shape of the cabin provides the operator with an optimal 360° visibility in order to improve the safety on the jobsite and to make work more efficient.

The B7 Sigma-6 is equipped with four mirrors to help the operator control the work area without moving from his seat.





SAFETY

The structure of the B7 Sigma-6 cabin has been designed to meet the ROPS (Roll-Over Protective Structure) certification as well as the FOPS (Falling Object Protective Structure) level 1. The FOPS level 2 protective structure is optionally available as well as a front guard.

LED LIGHTING: EFFICIENCY AND LOW CONSUMPTION

In order to work safely, efficiently and with accuracy in the darkness, the B7 Sigma-6 comes standard with 3 LED lights, one positioned on the inner part of the boom, and two at the front of the cabin. The LED technology provides a powerful light while reducing energy consumption and this increases the service life of the battery. An optional beacon and additional LED rear light can be added.

RELIABILITY

The structure of the undercarriage, as well as the steel covers provide an optimal protection and longer service life. All hoses are protected with abrasion-resistant sleeves. Furthermore, a lot of care has been paid to the hose routing on the working equipment, and all hoses are covered with steel plates. These measures enhance the service life and reduces downtime of the machine. The blade and the boom cylinder are also fully protected by steel plates.

BEST COMPONENTS

All B7 Sigma-6 components were designed in order to make it reliable, durable and capable of performing demanding work.

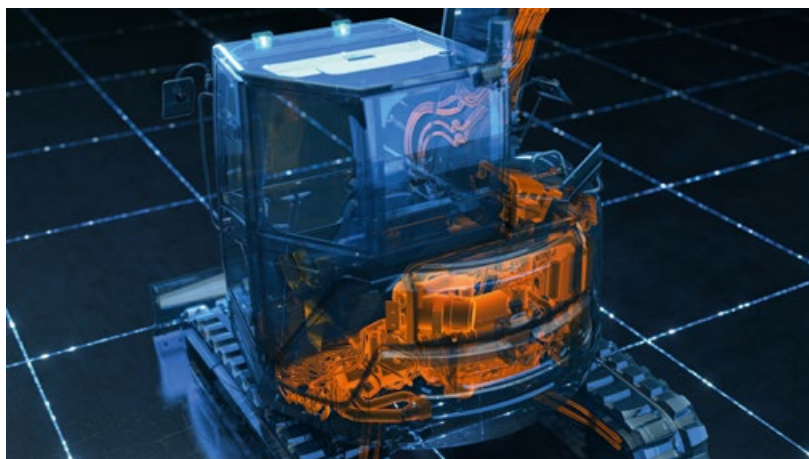

MAINTENANCE

EASY ACCESS

Daily maintenance has to be performed easily. There is one easy to open engine bonnet and the right-hand side cover is mounted on one hinge to open easily. This gives an access to all major elements: air filter, A/C compressor, radiator, refueling pump, battery, fuel tank, hydraulic oil tank, alternator, engine oil dipstick, water separator, coolant level, etc...

The fuses and relays are located under the seat and are easy accessible.



LONG SERVICE INTERVALS

Yanmar excavators are designed for working and therefore we increase the service intervals.

For our DPF (Diesel Particulate Filter) the DOC (Diesel Oxidation Catalyst) is maintenance free, and the SF (Soot Filter) needs only to be cleaned every 3000 hours, which reduces downtime.



1. Fuel filter with water separator / 2. A/C Compressor / 3. Air Filter / 4. Battery / 5. Fan Belts / 6. Refueling pump

EQUIPMENT



[STANDARD EQUIPMENT]

PERFORMANCE

4TNV98C-WBV2 Yanmar diesel | Meets Stage V | Particle filter | Auto-Idle System (auto deceleration) | Eco mode | Proportional 3rd hydraulic circuit lines to boom end on right joystick | Potentiometer on 3rd circuit to regulate oil flow | Automatic 2nd speed | 2 LED working lights on cabin

COMFORT

LCD interface | Cabin ROPS FOPS 1 | Comfort seat with pneumatic suspension | Adjustable wrist supports | Foot rests | Sliding double right side window | Transparent upper front part | Air conditioning | Radio with USB connection | 2 x 12V outlets | Wide travel pedals | Windshield with two fully retractable parts | Windshield washer | Storage boxes | Secure document storage | Cup holder

SAFETY AND DURABILITY

VICTAS Crawlers | Handrails | Seat belt with retractor | Evacuation hammer | Anchor points | 4 mirrors | Horn | Travel alarm

MISCELLANEOUS

Electric refueling pump | Operator's manual | Spare parts manual | Grease pump | Tool box

[OPTIONAL EQUIPMENT]

EQUIPMENT AND PERFORMANCE

Special paint | Bio oil | Additional counterweight | Proportional 3rd circuit's lines until arm end | ½ circuit | Push-pull | Line high pressure for hydraulic quick coupler | 1 LED working lights on cabin behind | 1 LED flashing rotary fixed on cabin | Beacon light with magnetic base

COMFORT AND EASE OF USE

Skaï seat

SAFETY AND DURABILITY

Anti-theft device (key / keypad) | FOPS 2 Protection bars on cab roof + front bars | Kit bolted pads, durable reinforced and cut resistant rubber

[ATTACHMENTS]

Yanmar gives you the accessories that fit your needs and match the safety standards in force in your country: mechanical quick coupler, hydraulic quick coupler, ditching buckets, swinging buckets, backhoe bucket, hydraulic hammer...



DIMENSIONS

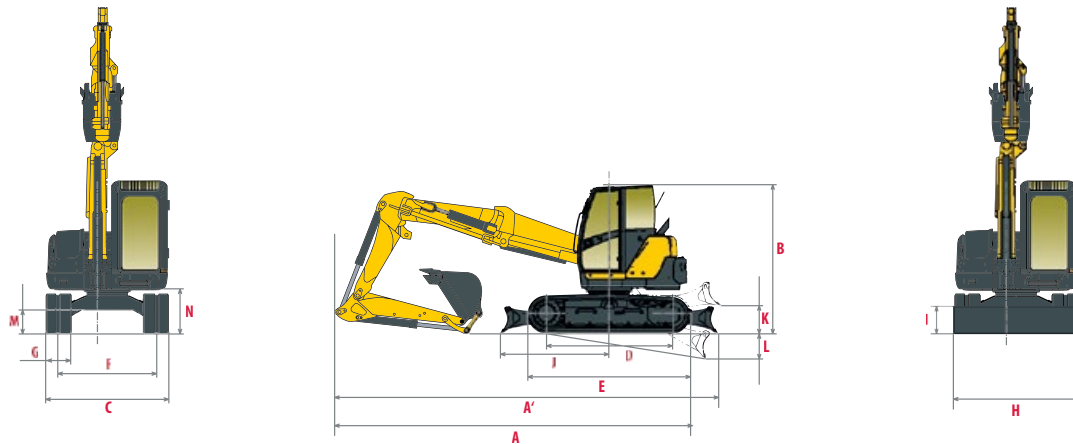

A Overall length	5850 mm	H Overall blade width	2270 mm
A' Overall length with blade at the back	6200 mm	I Overall blade height	435 mm
B Overall height	2680 mm	J Blade distance	1830 mm
C Overall width	2270 mm	K Max. lifting height above the ground	440 mm
D Length of track on ground	2290 mm	L Max. lowering depth from the ground	380 mm
E Undercarriage length	2890 mm	M Minimum ground clearance	390 mm
F Lane	1870 mm	N Ground clearance under counterweight	700 mm
G Track width	450 mm		

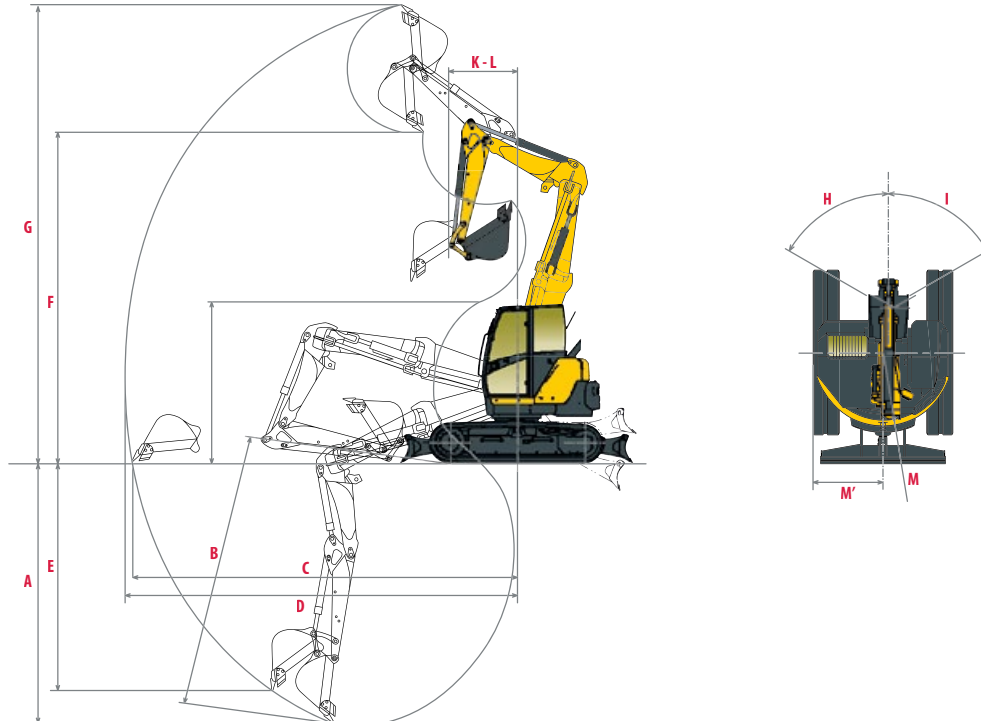



A Max. digging depth - Blade lifted	4180 mm	H Boom offset base to left	1060 mm
B Max. digging depth - Blade lowered	4450 mm	I Boom offset base to right	870 mm
C Max. digging reach on ground	6370 mm	J Arm length	1680 mm
D Max. digging reach	6520 mm	K Front minimum turning radius	1320 mm
E Max vertical wall	3690 mm	M Rear swing radius	1139 mm
F Max. unloading height	5540 mm	M' Rear swing radius with additional counterweight	1265 mm
G Max. cutting height	7530 mm		

Subject to technical modifications. Dimensions in mm with specific Yanmar bucket.

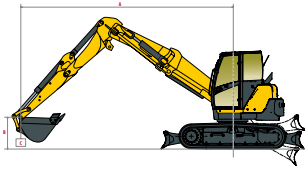









LIFTING FORCE













 Tipping load, rating over front

 Tipping load, B rating over side 90°











Standard counterweight, standard arm

Blade on ground										
A	Max.		5 m		4 m		3 m		2 m	
B										
6 m	*2840	*2840	-	-	-	-	*2835	*2835	-	-
5 m	*2425	*2425	-	-	*2460	*2460	*2680	*2680	-	-
4 m	1315	*2170	-	-	2080	*2390	*2920	*2920	-	-
3 m	1065	*2080	1195	*2170	1795	*2580	*3245	*3245	-	-
2 m	970	*2065	1140	*2250	1650	*2740	2520	*3740	-	-
1 m	905	*2040	1070	*2295	1490	*2890	2195	*3805	-	-
0 m	925	*2020	1020	*2225	1395	*2885	2090	*3680	-	-
-1 m	-	-	985	*1950	1325	*2620	2000	*3250	*3665	*3665
-2 m	1225	*1785	-	-	1350	*2075	2050	*2645	*3060	*3060
-3 m	*1275	*1275	-	-	-	-	*1305	*1305	-	-











Standard counterweight, standard arm

Blade above ground										
A	Max.		5 m		4 m		3 m		2 m	
B										
6 m	*2840	*2840	-	-	-	-	*2835	*2835	-	-
5 m	*2425	*2425	-	-	*2460	*2460	*2680	*2680	-	-
4 m	1300	1390	-	-	2040	*2390	*2920	*2920	-	-
3 m	1075	1140	1210	1280	1795	1945	*3245	*3245	-	-
2 m	950	1035	1135	1230	1660	1785	2540	2805	-	-
1 m	905	960	1065	1140	1500	1600	2260	2470	-	-
0 m	910	965	1010	1070	1385	1520	2055	2335	-	-
-1 m	-	-	975	1100	1330	1495	1985	2255	*3665	*3665
-2 m	1190	1265	-	-	1365	1450	1995	2205	*3060	*3060
-3 m	*1275	*1275	-	-	-	-	*1305	*1305	-	-

Additional counterweight, standard arm

Blade on ground										
A	Max.		5 m		4 m		3 m		2 m	
B										
6 m	*2840	*2840	-	-	-	-	*2835	*2835	-	-
5 m	*2425	*2425	-	-	*2460	*2460	*2680	*2680	-	-
4 m	1490	*2170	-	-	2305	*2390	*2920	*2920	-	-
3 m	1225	*2080	1360	*2170	2020	*2580	*3245	*3245	-	-
2 m	1120	*2065	1310	*2250	1880	*2740	2875	*3740	-	-
1 m	1055	*2040	1240	*2295	1720	*2890	2550	*3805	-	-
0 m	1080	*2020	1190	*2255	1625	*2885	2440	*3680	-	-
-1 m	-	-	1150	*1950	1550	*2620	2350	*3250	*3665	*3665
-2 m	1425	*1785	-	-	1580	*2075	2400	*2645	*3060	*3060
-3 m	*1275	*1275	-	-	-	-	*1305	*1305	-	-

Additional counterweight, standard arm

Blade above ground										
A	Max.		5 m		4 m		3 m		2 m	
B										
6 m	*2840	*2840	-	-	-	-	*2835	*2835	-	-
5 m	*2425	*2425	-	-	*2460	*2460	*2680	*2680	-	-
4 m	1450	1575	-	-	2270	*2390	*2920	*2920	-	-
3 m	1235	1305	1380	1455	2025	2180	*3245	*3245	-	-
2 m	1100	1190	1305	1405	1885	2020	2890	3160	-	-
1 m	1055	1110	1235	1315	1730	1835	2610	2830	-	-
0 m	1065	1125	1180	1250	1615	1750	2405	2695	-	-
-1 m	-	-	1145	1270	1560	1730	2335	2610	*3665	*3665
-2 m	1390	1470	-	-	1595	1685	2345	2565	*3060	*3060
-3 m	*1275	*1275	-	-	-	-	*1305	*1305	-	-

[The data contained in these tables represent the lifting capacity in accordance with ISO standard 10567. They don't include the weight of the bucket and correspond to 75% of the maximum static tipping load or 87% of the hydraulic lifting power. Data marked * are the hydraulic limits of the lifting power.]

SPECIFICATIONS

[WEIGHT +/- 2% (EN STANDARDS)]

	Weight	Ground pressure
Operating weight (rubber tracks)	8,200 kg	0,365 kg/cm ²
Transport weight (rubber tracks)	8,125 kg	0,361 kg/cm ²
With steel tracks	8,180 kg	0,366 kg/cm ²
With additional counterweight	+ 400 kg	0,382 kg/cm ²
With FOPS II protection	+ 100 kg	0,369 kg/cm ²

[ENGINE]

Type	4TNV98C-WBV2
Fuel	Diesel
Net Power	39,3 kW (at 1900 rpm)
Gross Power	41,4 kW (at 1900 rpm)
Displacement	3,318 l
Maximum torque	229 - 241 N.m
Cooling	Liquid
Starter	3 kW
Battery	12V - 92 Ah
Alternator	12V - 80 A

[HYDRAULIC SYSTEM]

Maximum pressure	255 bar
1 double piston pump with variable flow	2 x 70,3 l/min
1 gear pump	59,8 l/min
1 gear pump for pilot line	19 l/min

PTO	Theoretical data at 1900 rpm	
	Pressure	Oil flow
2 ways	250 - 1,5 bars	18,3 - 125 l.min ⁻¹
1 way	250 - 1,5 bars	18,3 - 125 l.min ⁻¹



Oil flow decreases as the pressure increases

[PERFORMANCE]

Travel speed	2,7 / 4,8 km/h (2,5 / 4,5 km/h with steel tracks)
Rotation speed	10 rpm
Digging force (arm)	40,6 kN
Digging force (bucket)	56,9 kN
Traction force	72,6 kN
Gradability	25°
Noise level (2000/14/CE & 2005/88/CE)	80 dB(A) (LpA) / 97 dB(A) (LwA)

[UNDERCARRIAGE]

Number of top rollers	1
Number of bottom rollers	5
Track tensioning system	Using grease pump

[CAPACITIES]

Fuel tank	115 l
Coolant	9 l
Engine oil	11,2 l
Hydraulic circuit	112 l
Hydraulic tank	60 l

MAINTENANCE FREQUENCY

[Change engine oil and filter: **500 hours**] [Change fuel filter: **500 hours**] [Change hydraulic oil filter: **1000 hours**]
 [Change cooling fluid: **2000 hours**] [Cleaning particle filter: **3000 hours**] [Change particle filter: **9000 hours**]



YANMAR



Yanmar Construction Equipment Europe
25, rue de la Tambourine, 52100 SAINT-DIZIER
France

ycee-contact@yanmar.com

www.yanmarconstruction.eu

Printed in France - Materials and specifications are subject to change from the manufacturer without notice - Please contact your local Yanmar Construction Equipment Europe dealer for further information.

GB_B7-6_0117