



YANMAR

SV60-6B

MINI-EXCAVATOR



Operating weight

5 655 kg

Engine gross power

34.5 kW / 44.8 HP at 2200 rpm

Digging force (arm)

27.3 kN

Digging force (bucket)

41.9 kN

WELCOME TO THE YANMAR BUSINESS CLASS





COMPACT DESIGN

Designed to excel, even when faced with the most complex tasks, the 5.6 tonne SV60-6B is compact, lightweight and has a working envelope of just 3,565mm. Thanks to impressive power and excellent stability, the mini-excavator is perfect for a wide range of applications, including urban renewal, earthmoving, demolition, grading and landscaping.



INNOVATIVE ENGINE

Featuring a state-of-the-art engine from Yanmar's pioneering TNV series, the SV60-6B benefits from direct injection, which ensures maximum performance, minimum fuel consumption and low emission levels. Auto-deceleration technology and Eco-mode are also fitted as standard.



VIPPS HYDRAULIC SYSTEM

Thanks to Yanmar's acclaimed ViPPS hydraulic system, which cumulates the flow of separate pumps in order to achieve the perfect combination of speed, power and smooth performance, operators can simultaneously perform multiple tasks, even while travelling.



EXCELLENT STABILITY

Incorporating an innovative X-frame undercarriage design, alongside perfect weight distribution and a short tail overhang, the SV60 achieves outstanding stability.



UNBEATABLE PERFORMANCE

With high performance powerline components (engine, hydraulic pump and control valve), operators can undertake heavy-duty jobs in even the tightest work sites. This not only maximises efficiency, but also improves productivity.



SPACIOUS AND COMFORTABLE CAB

As with every model in Yanmar's compact portfolio, particular focus has been given to the design of the operator station. Embracing 'Universal Design' principles, the SV60-6B boasts the widest cab in its class, increased leg room, new electronic instrumentation, improved ergonomics, air suspension seat and a rear view camera as standard.



SIMPLE OPERATION

With ergonomically-placed control levers, operators benefit from precise movement. All the main controls are located on the joysticks, ensuring maximum efficiency, impressive productivity and unbeatable simplicity.



HIGH-QUALITY COMPONENTS

Developed in Japan using best-in-class components, the SV60 is renowned for its durability, reliability and long service intervals.



EASY MAINTENANCE

Featuring five hoods and service openings, operators have easy access to components for both daily checks and routine maintenance requirements.

COMPACT DESIGN



The perfect combination of technology and innovation, the SV60-6B delivers the performance of a mini-excavator while enjoying the compact dimensions of a more compact model. Designed with performance in mind, the SV60-6B blends impressive power, versatility, comfort and reliability into a highly compact package.



PERFECT FOR URBAN JOB SITES

With a short rear overhang and tight front turning radius (2,240mm), the 5.6 tonne SV60-6B is compact, lightweight and has a working envelope of just 3,565mm. Perfectly suited to urban job sites, it can operate in a single lane of traffic.

360° WORKING ENVELOPPE

Diameter : **4480 mm** (no offset) / **3680 mm** (offset)

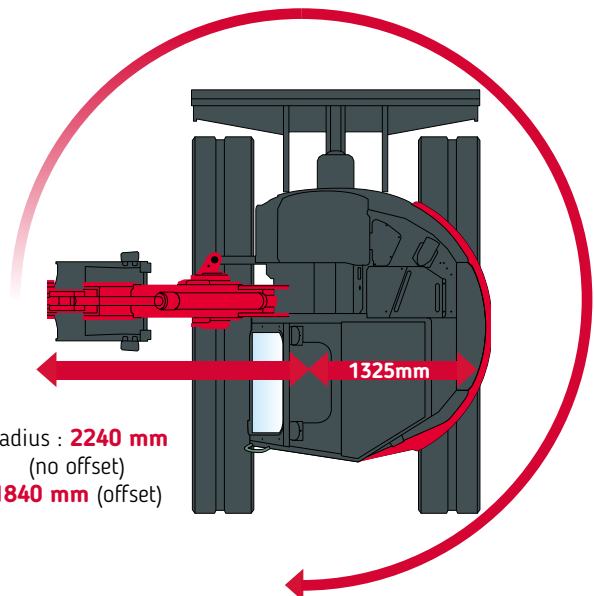

STABILITY



EXCELLENT WEIGHT DISTRIBUTION, EXCEPTIONAL LIFTING FORCES

Thanks to a unique undercarriage design, alongside perfect weight distribution and a short tail overhang, the SV60-6B achieves outstanding stability and remarkable lifting capacities. The mini-excavator can carry a one ton load up to a 5.10m at 1.25m high. Available as an optional extra, an additional 200kg counterweight can further improve lifting performance.

X-SHAPED UNDERCARRIAGE

The X-shaped box section structure of the SV60's undercarriage ensures unbeatable torsional stiffness. The frame has been designed with maximum durability in mind, while the heavy-duty components ensure durability, reliability and long service intervals – resulting in a lower Total Cost of Ownership (TCO).



PERFORMANCE

Thanks to Yanmar's unique experience and expertise, the SV60 delivers excellent performance while ensuring a low environmental impact. Combining unmatched power, flexibility and precision, it's the perfect partner for productivity – even when faced with the most complex tasks.



NEXT-GENERATION YANMAR ENGINE

With an output of 33.5 kW at 2,200 rpm, Yanmar's electronically-controlled 4TNV86CT-PBVA engine is the result of continued efforts to achieve technology advances in fuel consumption and emissions reduction.

- + An ECU manages rpm according to torque, effectively optimising the engine load. This not only saves fuel, but also improves efficiency.
- + Auto-deceleration technology (available as standard) allows the engine to revert to idle if the operator hasn't touched the operating levers for more than four seconds.
- + Eco-mode (available as standard) reduces the motor speed by 300rpm – thus further reducing fuel consumption.



HIGH-PERFORMANCE TRANSMISSION

The SV60-6B benefits from a drive motor that develops 10% more torque, improved cycle times and impressive productivity – especially when it comes to levelling applications. All-new 'automatic 2-speed' drive motors are included as standard, which shift up and down (in second speed) depending on the effort required. In result, the operator is presented with the optimum solution (in terms of speed or pushing force), which makes operation easier and further improves efficiency.

VIPPS HYDRAULIC SYSTEM

Featuring ViPPS (ViO Progressive 3 Pump System) hydraulics, which uses four hydraulic pumps, two variable displacement pumps and two gear pumps, (including one for joysticks), the SV60-6B delivers a total flow of 139.4l/min. A control valve, based on the ViPPS principle, cumulates the flow of separate pumps in order to obtain the optimal combination of speed, power, smooth operation and balance.

In result, the system allows operators to perform multiple tasks, even while travelling – the ultimate working tool!



EASE OF USE

ADJUSTABLE PROPORTIONAL CONTROL OF THE AUXILIARY CIRCUITS

The SV60-6B is fitted, as standard, with an auxiliary hydraulic circuit. Operated via a proportional control located on the joystick, this allows the flow and oil direction to be easily adapted. In addition, thanks to an easy-to-operate potentiometer, flow can be easily adjusted to meet the specific requirements of your attachments.



- 1 Control of the first auxiliary hydraulic circuit
- 2 Flow adjustment (via potentiometer) of the first hydraulic circuit
- 3 Control of the second auxiliary hydraulic circuit
- 4 Flow adjustment (via potentiometer) of the second hydraulic circuit
- 5 Engine power controlled electronically by a potentiometer
- 6 Travel speed switch on the blade lever

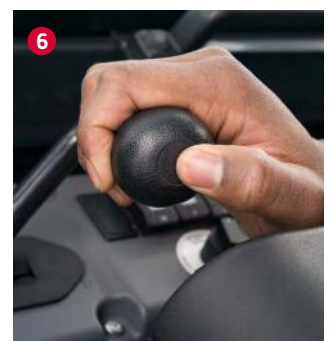

SPACIOUS AND COMFORTABLE CAB



XXL SPACE

Thanks to its innovative design, the SV60-6B cab boasts 41% more space than its closest competitors – equivalent to that of an eight-tonne mini-excavator. With large leg room and space to move around freely, operators can work efficiently and comfortably.

Unlike other models, the SV60-6B travel pedals are foldable and have been designed to deliver perfect ergonomics.



CONTROL PANEL

Harnessing Yanmar's 'Universal Design' concept, which puts the operator at the centre of machine design principles, all controls are easily accessible and grouped on the right hand side of the cab.

- 1 Wipers
- 2 Lights switch
- 3 Eco-Mode
- 4 Auto-Deceleration
- 5 Flashing beacon
- 6 Overload warning
- 7 Quick hitch



AIR CIRCULATION

With air condition fitted as standard, operators benefit from a pleasant working temperature – even in the most extreme weather conditions. Seven vents have been positioned around the cab to ensure air circulation uniformity, while a window demisting setting maximises operator efficiency.

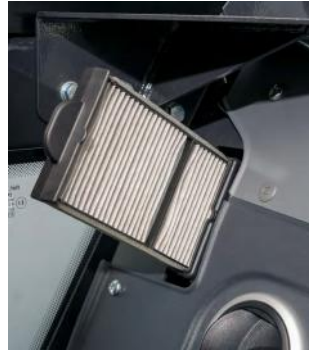

Even the air filters have been located in easy-to-access spaces, to ensure quick and simple maintenance.

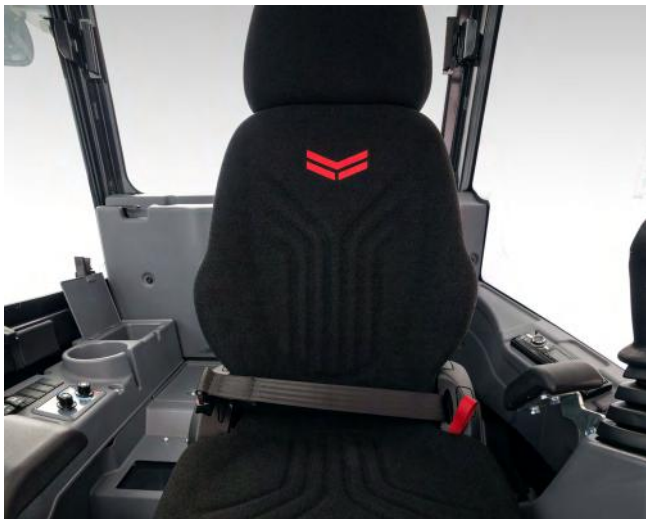

AIR SUSPENSION SEAT

Fitted with a fully-adjustable, air suspension seat (with headrest) as standard, the SV60-6B guarantees the highest levels of operator comfort – ensuring minimal fatigue while on the job site. Elsewhere, the roof window is fitted with an integrated sunshade for maximum comfort.



The roof window of the SV60-6B is protected by a fully integrated sunshade for a maximum comfort.

UNBEATABLE STORAGE

The SV60-6B incorporates numerous storage spaces, including bottle/cup holder, utility box, phone tray, document storage and even a dedicated lunchbox storage area behind the seat! All of these areas are located within arm's reach of the seat.



SETTING THE STANDARDS IN SAFETY



The SV60-6B cab has been designed to meet ROPS (Roll-Over Protective Structure) certification, as well as FOPS (Falling Object Protective Structure) level 1. The cab can be fitted with FOPS level 2 protection (front and top guard) as an optional extra.



360° VISIBILITY

In order to maximise operator safety and efficiency, the SV60-6B has been designed to provide 360° visibility. Alongside large glass panels, the roof window offers excellent visibility during loading and unloading, while three mirrors provide a complete view of the work area without the operator needing to leave their seat.

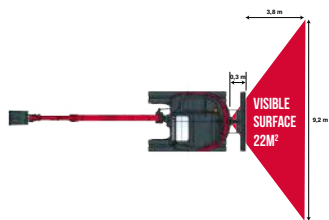

REAR VIEW CAMERA

As standard, the SV60-6B is fitted with a state-of-the-art rear view camera and 7" LCD screen. Fully-waterproof, night vision enabled and heated to ensure it doesn't freeze during the colder winter months, the camera boasts numerous settings, a mirror mode and even allows the option of fitting a second side camera.



ACCESSIBILITY

The SV60-6B has the largest cab entrance of any equivalent excavator on the market. This makes entering and exiting the cab easier and safer. Three handrails (marked 1, 2 and 3) are ideally positioned to match the operator's grip position, while a large footstep (with anti-slip technology) further improves safety on site.

RELIABILITY

Developed in Japan using best-in-class components, the SV60-6B is renowned for its reliability and long service intervals. The unique structure of the undercarriage, as well as the steel covers, provide optimum protection and a longer service life. In addition, the hose routing has been developed with durability in mind. These measures enhance the service life and reduce unnecessary machine downtime.

THE BEST PROTECTION ON THE MARKET

The SV60-6B benefits from complete cylinder protection. All tubes and rods are covered by a spring type steel plate, which further improves durability and minimises Total Cost of Ownership (TCO).



DIGITAL INTERFACE

Thanks to a state-of-the-art digital interface, the operator is informed (in real time) about exacting machine status details. Perfectly integrated into the right-hand console, the 3.3" screen provides the customer with useful information through LED lamps, or indications about important measures such as fuel consumption, fuel level and coolant temperature.

What's more, the interface informs the operator about maintenance intervals and works as a diagnostic tool by sending an error code and an information icon in the case of a malfunction.

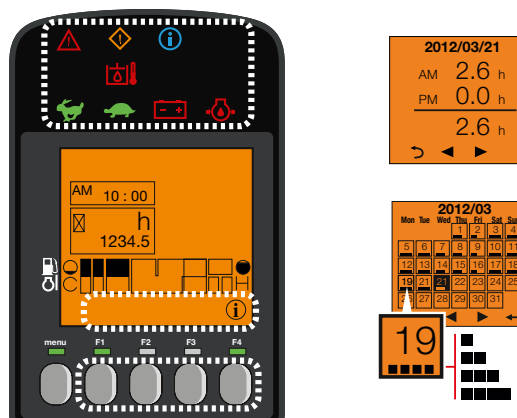

MAINTENANCE

EASY ACCESS

Thanks to the wide engine hood opening, operators have easy access to all major elements from the ground, including the air filter, compressor, battery, fuses, relays, fuel tank, hydraulic oil tank and engine oil dipstick.

LONG SERVICE INTERVALS

Thanks to innovative design and heavy-duty components, service intervals are kept to a minimum.





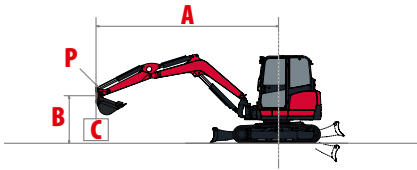





LIFTING FORCE











 Tipping load, rating over front

 Tipping load, rating over side 90°









Cabin, short arm, standard counterweight

A	Blade on ground					Blade above ground				
	Max.	5 m	4 m	3 m	2 m	Max.	5 m	4 m	3 m	2 m
B	(A=)									
4 m	4370	*1090	*1090	-	-	4370	*1090	*1090	-	-
3 m	4975	840	*1110	-	-	4975	790	865	-	-
2 m	5275	710	*1125	780	*1155	1080	*1300	*1770	*1770	-
1 m	5335	670	*1160	750	*1235	1020	*1560	1510	*2290	-
0 m	5165	695	*1210	735	*1270	1010	*1685	1480	*2470	2260
-1 m	4735	810	*1225	-	-	995	*1625	1445	*2305	2490
-2 m	3930	1005	*1200	-	-	-	-	1475	*1830	*2390









Cabin, short arm, additional counterweight

A	Blade on ground					Blade above ground				
	Max.	5 m	4 m	3 m	2 m	Max.	5 m	4 m	3 m	2 m
B	(A=)									
4 m	4370	*1090	*1090	-	-	4370	*1090	*1090	-	-
3 m	4975	915	*1110	-	-	4975	870	945	-	-
2 m	5275	780	*1125	860	*1155	1185	*1300	*1770	*1770	-
1 m	5335	745	*1160	825	*1235	1120	*1560	1660	*2290	-
0 m	5165	770	*1210	815	*1270	1115	*1685	1630	*2470	2545
-1 m	4735	890	*1225	-	-	1100	*1625	1595	*2305	2775
-2 m	3930	1110	*1200	-	-	-	-	1625	*1830	*2390

Cabin, long arm, standard counterweight

A	Blade on ground					Blade above ground				
	Max.	5 m	4 m	3 m	2 m	Max.	5 m	4 m	3 m	2 m
B	(A=)									
4 m	4710	*990	*990	-	-	4710	*990	*990	-	-
3 m	5265	710	*1005	790	*970	-	-	775	*970	-
2 m	5545	645	*1020	760	*1070	*1200	*1200	-	-	-
1 m	5605	615	*1050	730	*1170	1015	*1470	1490	*2130	-
0 m	5445	625	*1110	715	*1245	1005	*1655	1475	*2405	2330
-1 m	5045	705	*1135	-	-	960	*1625	1415	*2330	2335
-2 m	4315	870	*1150	-	-	955	*1355	1380	*1990	2350

Cabin, long arm, additional counterweight

A	Blade on ground					Blade above ground				
	Max.	5 m	4 m	3 m	2 m	Max.	5 m	4 m	3 m	2 m
B	(A=)									
4 m	4710	*990	*990	-	-	4710	*990	*990	-	-
3 m	5265	785	*1005	870	*970	-	-	850	*970	-
2 m	5545	710	*1020	835	*1070	*1200	*1200	-	-	-
1 m	5605	685	*1050	805	*1170	1115	*1470	1640	*2130	-
0 m	5445	695	*1110	790	*1245	1110	*1655	1625	*2405	2615
-1 m	5045	780	*1135	-	-	1065	*1625	1565	*2330	2620
-2 m	4315	960	*1150	-	-	1060	*1355	1530	*1990	2635

[Yanmar offers a complete range of attachments to suit your needs and match the safety standards in force in your country: mechanical quick coupler, hydraulic quick coupler, powertilt, standard/grading/symmetric buckets, hydraulic breaker, tiltrotators, etc.]

DIMENSIONS

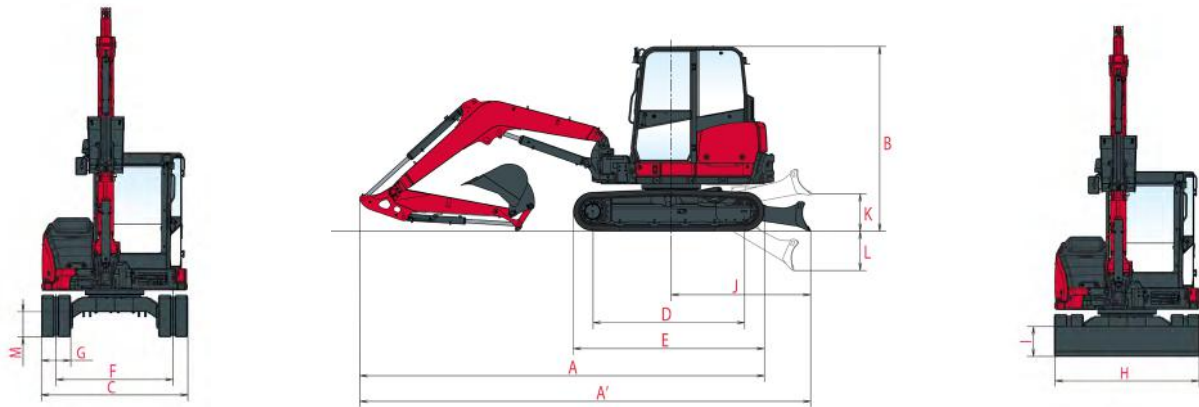

A Overall length	5 595 / 5 675* mm	G Track width	400 mm
A' Overall length with blade at the back	6 155 / 6 235* mm	H Overall blade width	1 970 mm
B Overall height	2 540 mm	I Overall blade height	400 mm
C Overall width	1 990 mm	J Blade distance	1 890 mm
D Length of track on ground	2 070 mm	K Max. lifting height above the ground	510 mm
E Undercarriage length	2 500 mm	L Max. lowering depth from the ground	535 mm
F Lane	1 590 mm	M Minimum ground clearance	345 mm

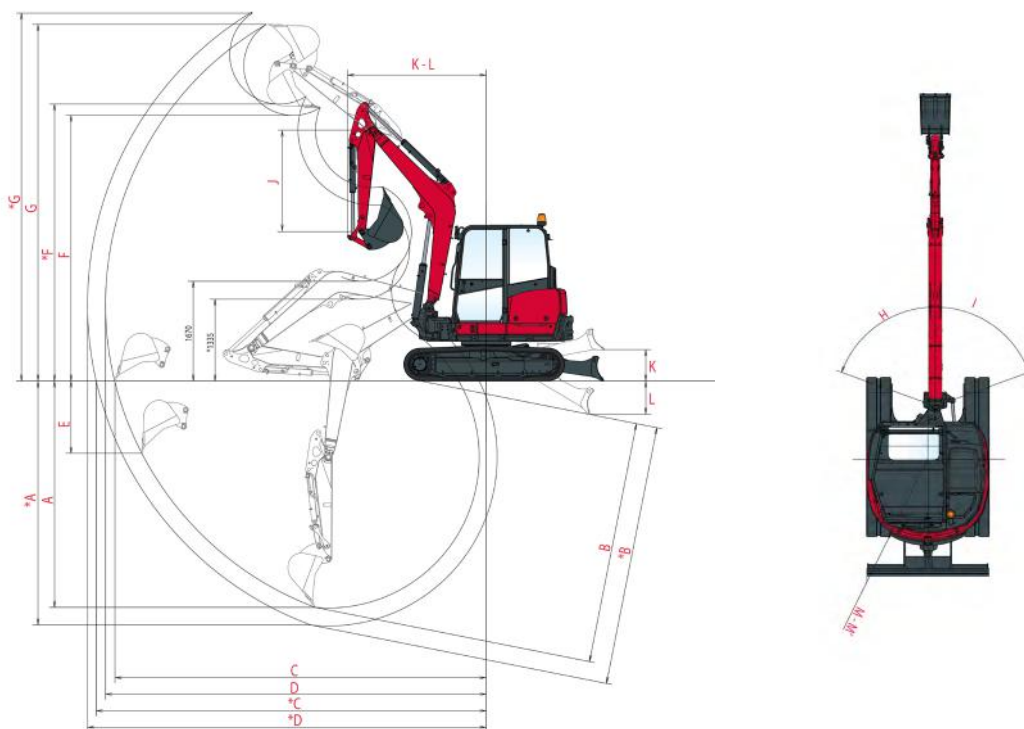

A Max. digging depth - Blade lifted	3 650 / 3 945* mm	H Boom swinging base to left	70°
B Max. digging depth - Blade lowered	3 910 / 4 200* mm	I Boom swinging base to right	70°
C Max. digging reach on ground	5 990 / 6 265* mm	J Arm length	1 650 / 1 940* mm
D Max. digging reach	6 135 / 6 410* mm	K Front turning radius	2 240 mm
E Max. vertical wall	1 165 mm	L Front turning radius with boom swing	1 840 mm
F Max. unloading height	4 280 / 4 460* mm	M Rear turning radius	1 325 mm
G Max. cutting height	5 720 / 5 900* mm	M' Rear turning radius with additional counterweight	1 405 mm

* with long arm

SPECIFICATIONS

[WEIGHT +/- 2% (EN STANDARDS)]

	Weight	Ground pressure (operating weight)
Operating weight (Rubber tracks / Cabin)	5 655 kg	0,314 kgf/cm ²
Transport weight (Rubber tracks / Cabin)	5 580 kg	0,310 kgf/cm ²
Operating weight (Steel tracks / Cabin)	5 685 kg	0,320 kgf/cm ²
Transport weight (Steel tracks / Cabin)	5 610 kg	0,316 kgf/cm ²
With additional counterweight	+ 200 kg	-
With FOPS II protection	+ 98 kg	-

[ENGINE]

Type	4TNV86CT-PBVA
Fuel	Diesel
Net Power	33,5 kW (at 2 200 rpm)
Gross Power	34,5 kW (at 2 200 rpm)
Displacement	2,091 l
Maximum torque	162.4 - 176.6 N.m (1560 +/- at 25 rpm)
Cooling	Water cooling
Starter	12 V - 2.3 kW
Battery	12 V - 100 Ah
Alternator	12 V - 80 A

[HYDRAULIC SYSTEM]

Maximum pressure	245 bars
1 double piston pump with variable flow	2 x 45.8 l.min ⁻¹
1 gear pump	37 l.min ⁻¹
1 gear pump for pilot line	10.8 l.min ⁻¹

PTO	Theoretical data at 2 200 rpm	
	Pressure (bar)	Flow (l.min ⁻¹)
2 ways	0 - 245	37 - 82.8
1 way	0 - 245	37 - 82.8

 Oil flow decreases as the pressure increases

[PERFORMANCE]

Travel speed (low / high)	2.2 / 4.7 km/h
Rotation speed	10 rpm
Digging force (long arm / short arm)	24.8 / 27.3 kN
Digging force (bucket)	41.9 kN
Gradability	30°
Noise Level (2000/14/CE&2005/88/CE)	Lwag: 94 dBA ; Lpag: 78 dBA

[UNDERCARRIAGE]

Number of top rollers	1
Number of bottom rollers	4
Track tensioning system	Grease adjuster

[CAPACITIES]

Fuel tank	100 l
Coolant	7.4 l
Engine oil	7.4 l
Hydraulic circuit	74 l
Hydraulic tank	38 l

[MAINTENANCE FREQUENCY]

[Change engine oil and filter : **50 hours (1st) / 500 hours (2nd)**] [Change fuel filter : **500 hours**] [Change hydraulic oil filter : **1000 hours / 1 year**] [Change hydraulic oil return filter : **50 hours (1st) / 500 hours (2nd)**] [Change cooling fluid : **2000 hours or 2 years**] [Clean particulate filter : **3000 hours**] [Change particulate filter : **9000 hours**]

EQUIPMENT

[STANDARD EQUIPMENT]

PERFORMANCE

4TNV86CT Yanmar diesel | Direct Injection | Engine Control Unit (ECU) | Eco-Mode | Auto-Deceleration System | VIPPS Hydraulic system (ViO Progressive 3 Pump System) | 3rd hydraulic circuit to arm end with adjustable proportional control by potentiometer | Automatic 2nd speed | External hydraulic oil gauge | 1 LED light integrated into the boom.

COMFORT

LCD interface | Adjustable and reclining seat with fabric covers, air suspension and headrest | Rearview camera with its associated screen | Heating | Adjustable wrist support | Foot rests | Wide travel pedals | Windshield with 2 fully retractable parts | Sliding double right-side window | Transparent upper front part | Integrated sunshades | Wipers | Windshield washer | Automatic ceiling lamp | 1 x 12V outlet | Storage boxes.

SAFETY AND DURABILITY

Handrails | Safety lever | Seat belt with retractor | Evacuation hammer | Anchor points | 3 mirrors | Horn | Blade cylinder supply hose into two parts | Complete protection of the cylinders (bucket, boom, arm and blade) | Hoses protected by abrasion resistant sleeves | Lockable covers | Electric refuelling pump.

MISCELLANEOUS

Fuel gauge | Toolbox | Toolkit | Grease pump.

[OPTIONAL EQUIPMENT]

EQUIPMENT AND PERFORMANCE

Steel crawlers | Pads for steel crawlers | Long arm (+290 mm) | Additional counterweight (+200 kg) | 4th hydraulic circuit with adjustable proportional control by potentiometer | Clamshell bucket circuit | Quick hitch line 150 bar | Quick couplers | Bio oil | 2 LED lights at the front of the cabin | 1 LED beacon fixed or with magnetic base | Kit 1 rear LED light + 1 beacon fixed | Improved fuel filtration.

COMFORT AND EASE OF USE

Air conditioning | Adjustable and reclining seat with skai covers, air suspension and headrest | Seat cover | Radio bluetooth | Documentation box | Central greasing.

SECURITY AND DURABILITY

Safety valves for lifting + overload warning | FOPS 2 protection (front + top guard) | Anti-theft device (key/keyboard) | GPS Tracking | Travel alarm | Removable battery cut-off switch.

[ATTACHMENTS]

Yanmar gives you the attachment that fit your needs and match the safety standards in force in your country: mechanical quick coupler, hydraulic quick coupler, powertilt, standard, grading or symmetric buckets, hydraulic breaker, tiltrotators...



YANMAR



Yanmar Compact Equipment EMEA

GB_SV60-6B_1221



www.yanmar.com

**TOGETHER
WE BUILD**

Printed in France – Materials and specifications are subject to change from the manufacturer without notice – Please contact your local Yanmar Compact Equipment EMEA dealer for further information.