



# REFORM

NCPA Contract 07-98

The sample page to the right illustrates the various elements that make up the descriptions and specification process for products in this book.

- 1. Product Identifying Number (PIN) and Name**
- 2. Product Illustrations**  
Elevation, section and plan illustrations
- 3. Product Information**  
Lists features & specification information that is required for product ordering. Restrictions, exceptions, variations and important considerations for the application, installation, or ordering of a product are found here.
- 4. Decision Step**  
Step-by-step process by which a complete product number and price is "built" and choices such as size, finish, and color are specified.
- 5. Base Price**  
Price for a particular size or style
- 6. Upcharge**  
Charge added to base price for specific dimensions, materials, or finishes
- 7. Complete Product Number**  
Completed by specifier, number reflects the exact product to be ordered

1 **i2212 DOUBLE-GROOVE MAKE-UP GYPSUM PANEL**

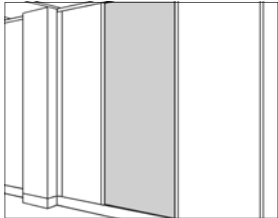

**2**

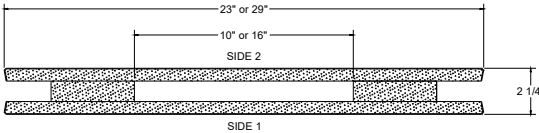

**3 PRODUCT INFORMATION**

- Features:**
  - Consists of two face sheets and two coreboards that are not laminated together as a panel assembly
  - Field-assembled to finish off a wall run between two fixed points
  - Adhesive required to assemble make-up panel
  - Acoustical batts increase STC rating of wall panels
- Specifiers:**
  - Identify ceiling height and panel width
  - Identify acoustical batting option
  - Identify surface finish for side 1 and side 2
  - See appendix for vinyl styles and colors
  - Specify "0000" for unfinished panels; panels must be field-finished
  - For "CUS" option - supply 3.3 linear yards (min) per side

**4**

Panel Height & Width		
108.11	9' x 11"	\$240
120.11	10' x 11"	\$256
108.23	9' x 23"	\$240
120.23	10' x 23"	\$256
108.29	9' x 29"	\$294
120.29	10' x 29"	\$316

**5**

Batting	
NA	none
BX	acoustical batts +\$43

**6**

Surface Finish Side 1 / Side 2		
First 2 digits specify series, last 2 specify color		
0000	unfinished	+0
CUS	customer material	\$7
AD__	adobe	\$29
----	price category 1	\$68
----	price category 2	\$76
----	price category 3	\$86
----	price category 4	\$112
----	price category 5	\$155
----	price category 6	\$227
----	price category 7	\$292

**7**

i	2	2	1	2	.														
---	---	---	---	---	---	--	--	--	--	--	--	--	--	--	--	--	--	--	--

2 REFORM

INSCAPE

**i2110 CEILING RUNNER**

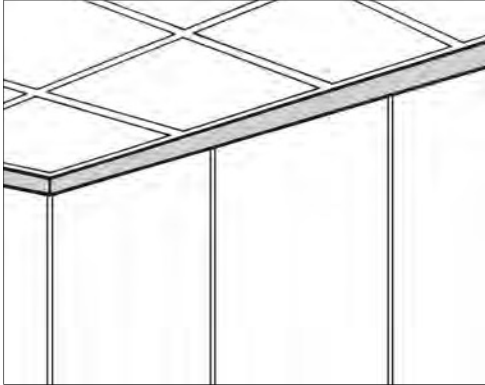

**PRODUCT INFORMATION**

**Features:**

- 12' aluminum top channel attaches to the ceiling and holds panels, glazing, and door units in place.
- Backed with polyfoam light and sound seal gaskets
- Punched with holes every 8" on center to allow electrical conduit from above the ceiling to enter panel chaseways
- Splice clips and assembly screws are included

**Note:** Measure overall length of wall run, including door and glazed openings, and round up to next 2' increment.

Example: A 12'10" wall run rounds up to 14'

Add up all rounded wall run lengths and divide by 12 for order quantity

**Specifiers:**

- Identify trim finish color

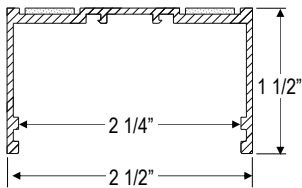

Product Number		Trim Finish
i2110	\$256	B3B2B0 alum
		9FA1A0 anodized
		EDE9E0 base white
		C0B7A8 desert storm
		89989D epoxy blue
		4F4546 espresso
		918D81 glimmer bronze
		48494D graphite
		F3FDFF ice white
		323836 matte slate
		B8AEA3 metallic stone
		40403F midnight black
		201920 onyx
		605746 rust bronze
		636D6F space grey
		EAEBE6 stone white
		A49E9E warm grey

i | 2 | 1 | 1 | 0 | . |

□ □

**i2111 CASED OPENING CLOSURE**

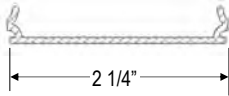
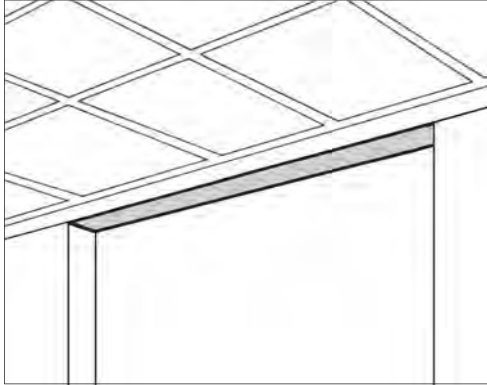

**PRODUCT INFORMATION**

**Features:**

- 12' aluminum extrusion forms a finished opening in the wall by snapping into the opening of the Ceiling Runner (i2110)
- Finishes a vertical jamb by snapping into a compound connector (i.e. Wall Start i2310)

**Specifiers:**

- Identify trim finish color

Product Number	Trim Finish
i2111 \$80	<b>B3B2B0</b> alum <b>9FA1A0</b> anodized <b>EDE9E0</b> base white <b>C0B7A8</b> desert storm <b>89989D</b> epoxy blue <b>4F4546</b> espresso <b>918D81</b> glimmer bronze <b>48494D</b> graphite <b>F3FDFF</b> ice white <b>323836</b> matte slate <b>B8AEA3</b> metallic stone <b>40403F</b> midnight black <b>201920</b> onyx <b>605746</b> rust bronze <b>636D6F</b> space grey <b>EAEBE6</b> stone white <b>A49E9E</b> warm grey

i | 2 | 1 | 1 | 1 | . |

□ □

- i2120 FLOOR RUNNER**
- i2122 NARROW FLOOR RUNNER**
- i2124 NO BASE FLOOR RUNNER**

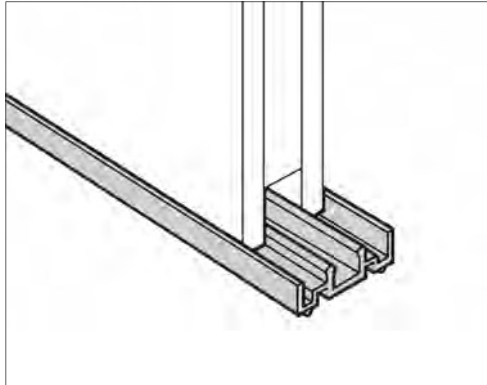

**PRODUCT INFORMATION**

**Features:**

- 12' aluminum extrusion anchors the bottom of panels to floor
- i 2120 accepts vinyl base (i 2140)
- i 2122 accepts 4" aluminum base (i 2142) and trimmed vinyl base (i 2140)
- i 2120 and i 2122 available with optional carpet teeth
- i 2124 does not have teeth option

**Note:** Measure overall length of wall run, excluding door openings and glazed sections which use fixed height sills mounted to the floor, and round up to next 2' increment.

Example: A 12'10" wall run rounds up to 14'

Add up all rounded wall run lengths and divide by 12 for order quantity

**Specifiers:**

- Identify product number
- Identify carpet teeth option (not available for i 2124)

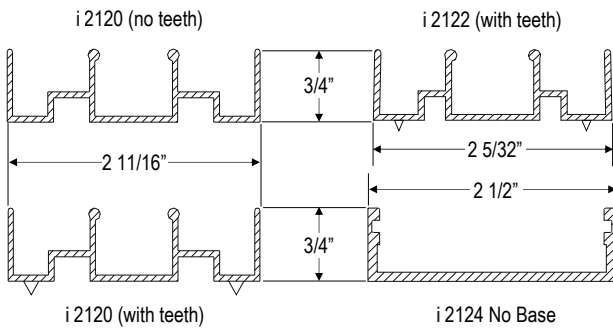

Product Number		
<b>i 2120</b>	Floor Runner	\$126
<b>i 2122</b>	Narrow Floor Runner	\$150
<b>i 2124.N</b>	No Base Floor Runner	\$194

Product #		
<b>N</b>	no teeth	\$0
<b>T</b>	1/4" teeth	\$25

i | 2 | 1 | 2 | . | |

# i2125 SIMPLE FLOOR RUNNER

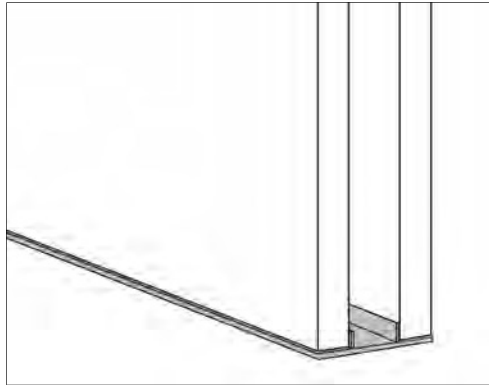

## PRODUCT INFORMATION

### Features:

- 12' aluminum extrusion allows standard construction type glue-on base trim

Product #	
i2125	\$112

i 2 1 2 5

# i2130 WIREWAY

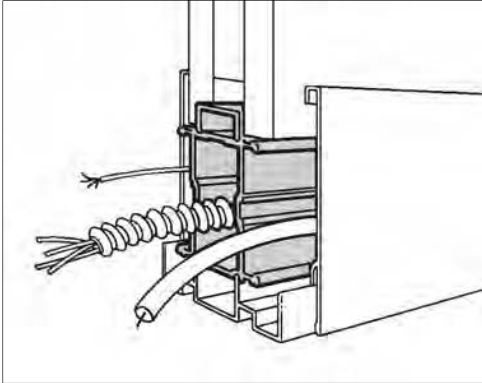

## PRODUCT INFORMATION

### Features:

- Assembly snaps into Floor Runner (i2120 or i2122) to provide a horizontal passageway for wires and cables at the base of panels
- Comes in a 12' length which is field-cut at installation
- 1' of wireway is needed for each panel
- Electrical cabling not included
- When Wallstrip Connectors are used at panel joints, wireway must be cut in sections to fit between them
- Wireway cannot be used in applications requiring 1-hour fire rating
- 4" wireway requires use of 6" Vinyl Base (i2140)
- Base Electrical System requires use of 4" Wireway

### Specifiers:

- Identify 3" or 4" wireway

Product Number		Size		
i2130	\$322	3	3"	+0
		4	4"	\$113

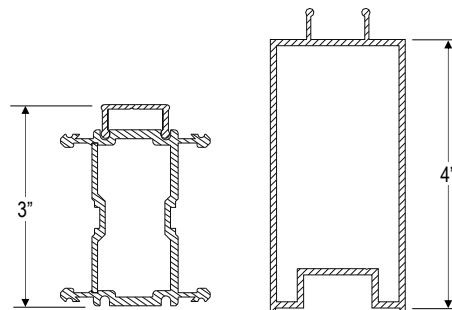

i 2 1 3 0 .

# i2211 DOUBLE-GROOVE ELECTRICAL GYPSUM PANEL

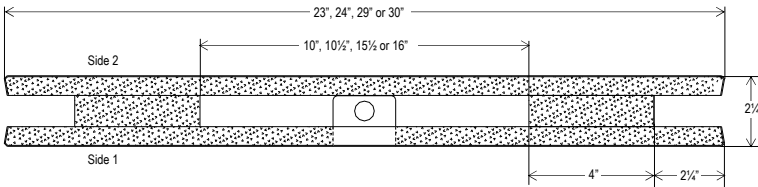
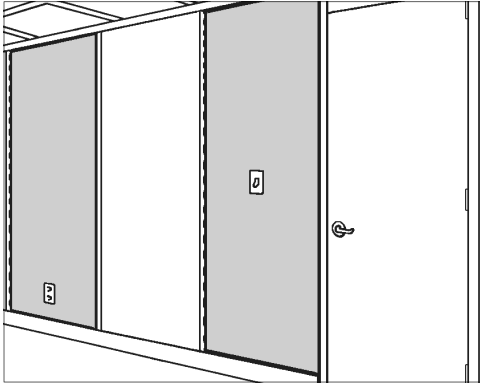

## PRODUCT INFORMATION

### Features:

- Unitized panel has a groove at each end
- Constructed of two 5/8" gypsum face panels laminated to two 1" gypsum studs
- Electrical components for specified options are pre-installed in the non-combustible 10" or 16"-wide chaseway
- Verify that electrical components supplied are approved for use by local building code and authorities
- Each electrical option, excluding "NA" and "E2", includes harness with UL listed connectors approx 3' from end to connect to power sources above the ceiling grid
- Class A fire rating
- Cover plates, switches, and outlets are not included and must be installed by a locally approved electrician
- Acoustical batts increase STC rating of wall panels

### Specifiers:

- Identify ceiling height and panel width. Specify each cut panel as full panel
- Identify electrical option for side 1 and side 2
- Identify acoustical batting option
- Identify surface finish for side 1 and side 2. Specify "0000" for unfinished panels; panels must be field-finished.
- For "CUS" option - supply 3.3 linear yards (min) per side

Ceiling Height & Panel Width		
<b>108.23</b>	9' x 23"	\$319
<b>120.23</b>	10' x 23"	\$341
<b>108.24</b>	9' x 24"	\$319
<b>120.24</b>	10' x 24"	\$341
<b>108.29</b>	9' x 29"	\$392
<b>120.29</b>	10' x 29"	\$420
<b>108.30</b>	9' x 30"	\$392
<b>120.30</b>	10' x 30"	\$420

Electrical Option Side 1 / Side 2		
<b>NA</b>	none	
<b>E1</b>	single duplex outlet, 120 volt	\$307
<b>E2</b>	single box with empty flex conduit for telecommunications	\$149
<b>E3</b>	combination of E1 and E2	\$455
<b>E4</b>	switch assembly, 120 volt	\$312
<b>E5</b>	switch assembly, 277 volt	\$312
<b>E6</b>	double duplex outlet	\$352
<b>E7</b>	combination of E2 and E6	\$457
<b>E8</b>	double switch assembly, 120 volt	\$568
<b>E9</b>	double switch assembly, 277 volt	\$568

Batting		
<b>NA</b>	none	+\$0
<b>BX</b>	acoustical batts	+\$58

Surface Finish Side 1 / Side 2		
First 2 digits specify series, last 2 specify color		
<b>0000</b>	unfinished	+\$0
<b>CUS</b>	customer material	+\$10
<b>AD</b>	adobe	+\$38
----	price category 1	+\$91
----	price category 2	+\$101
----	price category 3	+\$115
----	price category 4	+\$149
----	price category 5	+\$206
----	price category 6	+\$302
----	price category 7	+\$388

i 2 2 1 1 . . . . .

. . . . .

. . . . .



# i2142 ALUMINUM BASE

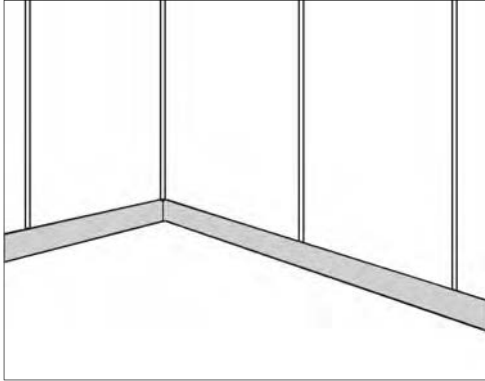

## PRODUCT INFORMATION

### Features:

- 8'5" Aluminum Base attaches to each side of the Narrow Floor Runner (i2122).
- For best application, field cuts of aluminum base ends should be positioned at panel joints.
- Package contains 2 units
- NOTE: This base cannot be used with gypsum wall products

### Specifiers:

- Identify aluminum base height
- Identify aluminum base color

Height			Trim Finish	
4	4"	\$406	B3B2B0	alum
6	6"	\$412	9FA1A0	anodized
			EDE9E0	base white
			C0B7A8	desert storm
			89989D	epoxy blue
			4F4546	espresso
			918D81	glimmer bronze
			48494D	graphite
			F3FDFF	ice white
			323836	matte slate
			B8AEA3	metallic stone
			40403F	midnight black
			201920	onyx
			605746	rust bronze
			636D6F	space grey
			EAEBE6	stone white
			A49E9E	warm grey

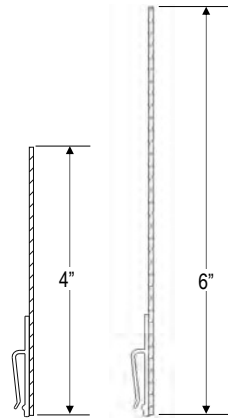

i 2 1 4 2 .

# **GYPSUM PANELS, ALUMINUM FRAMED PANELS & BUTT GLAZED PANELS**

# i2210 DOUBLE-GROOVE STANDARD GYPSUM PANEL

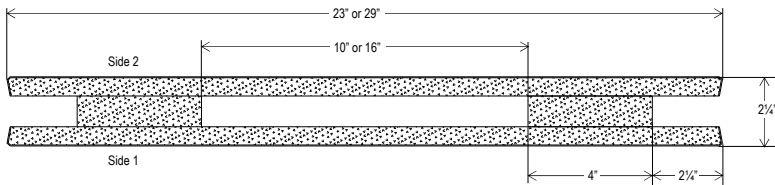
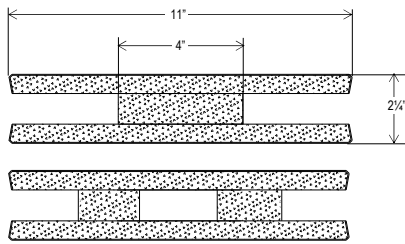
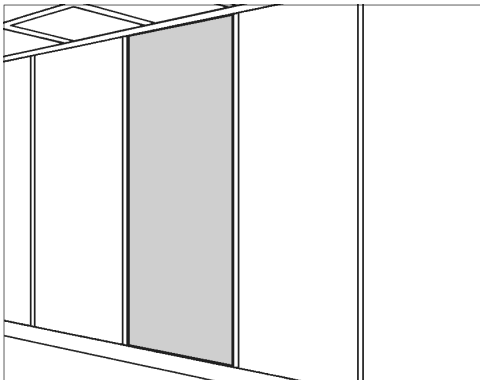

## PRODUCT INFORMATION

### Features:

- Unitized panel has a groove at each end
- Constructed of two 5/8" gypsum face panels laminated to two 1" gypsum studs, resulting in a 10" or 16"-wide, noncombustible chaseway
- Class A fire rating
- Acoustical batts increase STC rating of wall panels
- Acoustical batting is not available in 11" wide panel

### Specifiers:

- Identify ceiling height and panel width  
Specify each cut panel as the next-sized full panel
- Identify acoustical batting option
- Identify surface finish for side 1 and side 2  
See appendix for vinyl styles and colors.  
Specify "0000" for unfinished panels; panels must be field-finished
- For "CUS" option - supply 3.3 linear yards (min) per side

Ceiling Height & Panel Width		
108.11	9' x 11"	\$319
120.11	10' x 11"	\$341
108.23	9' x 23"	\$319
120.23	10' x 23"	\$341
108.29	9' x 29"	\$392
120.29	10' x 29"	\$420

Batting		
NA	none	+\$0
BX	acoustical batts	+\$58

Surface Finish Side 1 / Side 2		
First 2 digits specify series, last 2 specify color		
0000	unfinished	+\$0
CUS	customer material	+\$10
AD __	adobe	+\$38
----	price category 1	+\$91
----	price category 2	+\$101
----	price category 3	+\$115
----	price category 4	+\$149
----	price category 5	+\$206
----	price category 6	+\$302
----	price category 7	+\$388

i | 2 | 2 | 1 | 0 | . | | | . | | |

# i2210 DOUBLE-GROOVE CLERESTORY GYPSUM PANEL

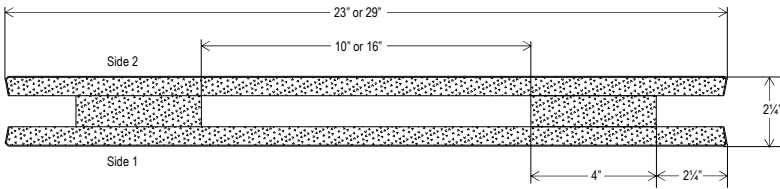
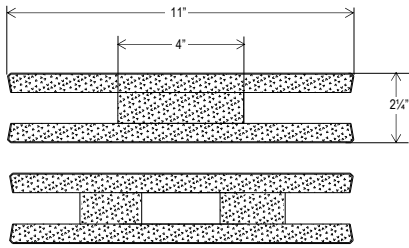
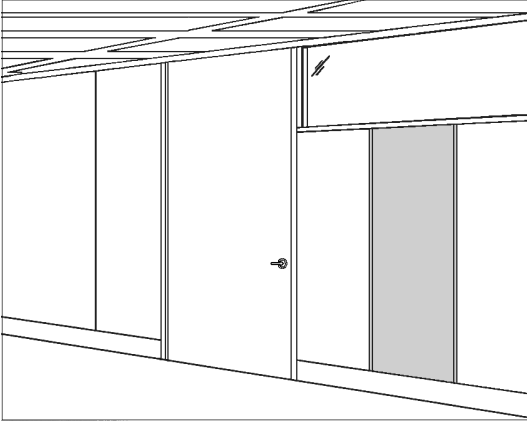

## PRODUCT INFORMATION

### Features:

- Unitized panel has a groove at each end
- Constructed of two 5/8" gypsum face panels laminated to two 1" gypsum studs
- Class A fire rating
- Panels are cut to a net height of 6'11". Other heights must be field cut or special ordered
- Acoustical batts increase STC rating of wall panels
- Acoustical batting is not available in 11" wide panel

### Specifiers:

- Identify clerestory height and panel width
- Identify acoustical batting option
- Identify surface finish for side 1 and side 2  
See appendix for vinyl styles and colors  
Specify "0000" for unfinished panels; panels must be field-finished
- For "CUS" option - supply 2.5 linear yards (min) per side

Clerestory Height & Panel Width		
11	7' x 11"	\$319
23	7' x 23"	\$319
29	7' x 29"	\$392

Batting		
NA	none	+\$0
BX	acoustical batts	+\$58

Surface Finish Side 1 / Side 2		
First 2 digits specify series, last 2 specify color		
0000	unfinished	+\$0
CUS	customer material	+\$8
AD __	adobe	+\$29
----	price category 1	+\$68
----	price category 2	+\$76
----	price category 3	+\$86
----	price category 4	+\$112
----	price category 5	+\$155
----	price category 6	+\$227
----	price category 7	+\$290

i 2 2 1 0 . 8 4 .

# i2211 DOUBLE-GROOVE ELECTRICAL GYPSUM PANEL

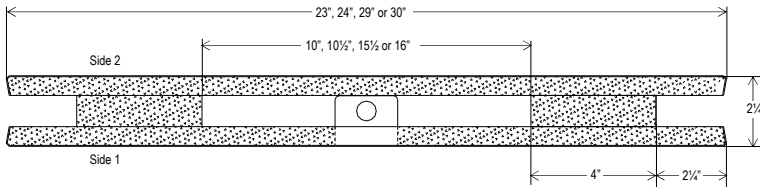
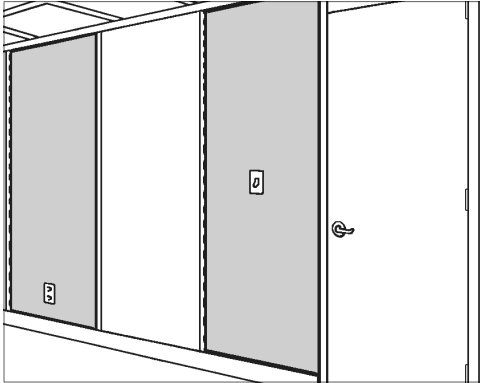

## PRODUCT INFORMATION

### Features:

- Unitized panel has a groove at each end
- Constructed of two 5/8" gypsum face panels laminated to two 1" gypsum studs
- Electrical components for specified options are pre-installed in the non-combustible 10" or 16"-wide chaseway
- Verify that electrical components supplied are approved for use by local building code and authorities
- Each electrical option, excluding "NA" and "E2", includes harness with UL listed connectors approx 3' from end to connect to power sources above the ceiling grid
- Class A fire rating
- Cover plates, switches, and outlets are not included and must be installed by a locally approved electrician
- Acoustical batts increase STC rating of wall panels

### Specifiers:

- Identify ceiling height and panel width. Specify each cut panel as full panel
- Identify electrical option for side 1 and side 2
- Identify acoustical batting option
- Identify surface finish for side 1 and side 2. Specify "0000" for unfinished panels; panels must be field-finished.
- For "CUS" option - supply 3.3 linear yards (min) per side

Ceiling Height & Panel Width		
<b>108.23</b>	9' x 23"	\$319
<b>120.23</b>	10' x 23"	\$341
<b>108.24</b>	9' x 24"	\$319
<b>120.24</b>	10' x 24"	\$341
<b>108.29</b>	9' x 29"	\$392
<b>120.29</b>	10' x 29"	\$420
<b>108.30</b>	9' x 30"	\$392
<b>120.30</b>	10' x 30"	\$420

Electrical Option Side 1 / Side 2		
<b>NA</b>	none	
<b>E1</b>	single duplex outlet, 120 volt	:\$307
<b>E2</b>	single box with empty flex conduit for telecommunications	:\$149
<b>E3</b>	combination of E1 and E2	:\$455
<b>E4</b>	switch assembly, 120 volt	:\$312
<b>E5</b>	switch assembly, 277 volt	:\$312
<b>E6</b>	double duplex outlet	:\$352
<b>E7</b>	combination of E2 and E6	:\$457
<b>E8</b>	double switch assembly, 120 volt	:\$568
<b>E9</b>	double switch assembly, 277 volt	:\$568

Batting		
<b>NA</b>	none	+\$0
<b>BX</b>	acoustical batts	\$58

Surface Finish Side 1 / Side 2		
First 2 digits specify series, last 2 specify color		
<b>0000</b>	unfinished	+\$0
<b>CUS</b>	customer material	+\$10
<b>AD</b>	adobe	+\$38
----	price category 1	+\$91
----	price category 2	+\$101
----	price category 3	+\$115
----	price category 4	+\$149
----	price category 5	+\$206
----	price category 6	+\$302
----	price category 7	+\$388

i 2 2 1 1 . . . . .

. . . . .

. . . . .

# i2212 DOUBLE-GROOVE MAKE-UP GYPSUM PANEL

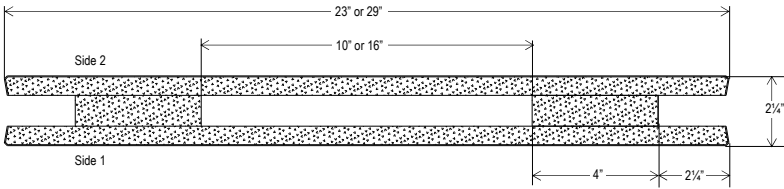
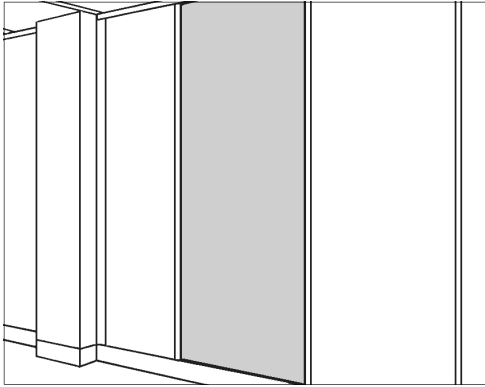

## PRODUCT INFORMATION

### Features:

- Consists of two face sheets and two coreboards that are not laminated together as a panel assembly
- Field-assembled to finish off a wall run between two fixed points
- Acoustical batts increase STC rating of wall panels

### Specifiers:

- Identify ceiling height and panel width
- Identify acoustical batting option
- Identify surface finish for side 1 and side 2  
See appendix for vinyl styles and colors  
Specify "0000" for unfinished panels; panels must be field-finished
- For "CUS" option - supply 3.3 linear yards (min) per side

Ceiling Height & Panel Width		
108.23	9' x 23"	\$312
120.23	10' x 23"	\$332
108.29	9' x 29"	\$383
120.29	10' x 29"	\$412

Batting		
NA	none	+\$0
BX	acoustical batts	+\$58

Surface Finish Side 1 / Side 2		
First 2 digits specify series, last 2 specify color		
0000	unfinished	+\$0
CUS	customer material	+\$10
AD __	adobe	+\$38
----	price category 1	+\$91
----	price category 2	+\$101
----	price category 3	+\$115
----	price category 4	+\$149
----	price category 5	+\$206
----	price category 6	+\$302
----	price category 7	+\$388

i	2	2	1	2	.			.		
---	---	---	---	---	---	--	--	---	--	--

--	--	--

--	--	--	--	--	--	--	--

# i2213 DOUBLE-GROOVE ACCESS GYPSUM PANEL

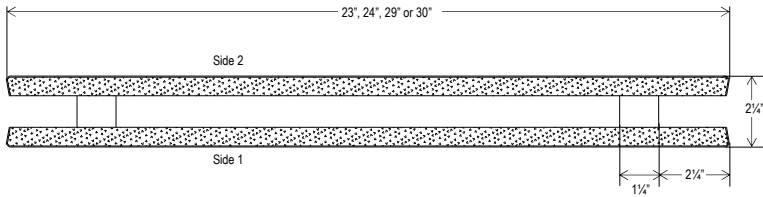
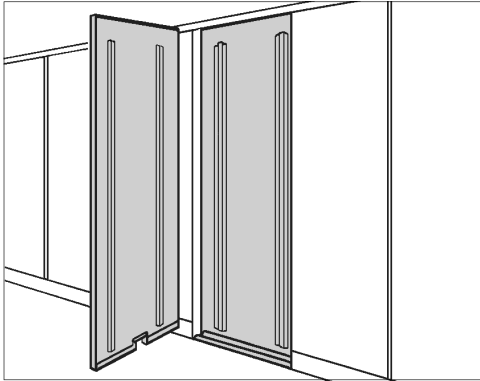

## PRODUCT INFORMATION

### Features:

- Demountable panel assembly has a groove at each end
- Constructed of two 5/8" gypsum face panels bonded to interlocking steel channels, resulting in a 16" to 23" wide non-combustible chaseway
- Side 2 of access panel has handle for separating the 2 panel halves.

**Note:** Locate Side 2 on inside of locked room to maintain security

- Class A fire rating
- Acoustical batts increase STC rating of wall panels

### Specifiers:

- Identify ceiling height and panel width.
- Identify acoustical batting option
- Identify surface finish for side 1 and side 2  
See appendix for vinyl styles and colors  
Specify "0000" for unfinished panels; panels must be field-finished
- For "CUS" option - supply 3.3 linear yards (min) per side

Ceiling Height & Panel Width		
108.23	9' x 23"	\$698
120.23	10' x 23"	\$752
108.24	9' x 24"	\$698
120.24	10' x 24"	\$752
108.29	9' x 29"	\$728
120.29	10' x 29"	\$790
108.30	9' x 30"	\$728
120.30	10' x 30"	\$790

Batting		
NA	none	+\$0
BX	acoustical batts	+\$58

Surface Finish Side 1 / Side 2		
First 2 digits specify series, last 2 specify color		
0000	unfinished	+\$0
CUS	customer material	+\$10
AD __	adobe	+\$38
----	price category 1	+\$91
----	price category 2	+\$101
----	price category 3	+\$115
----	price category 4	+\$149
----	price category 5	+\$206
----	price category 6	+\$302
----	price category 7	+\$388

i 2 2 1 3 . . . . .

. . . . .

. . . . . . . . . . .

# i2213 DOUBLE-GROOVE ACCESS GYPSUM PANEL

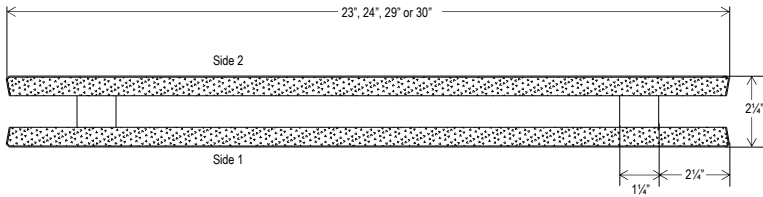
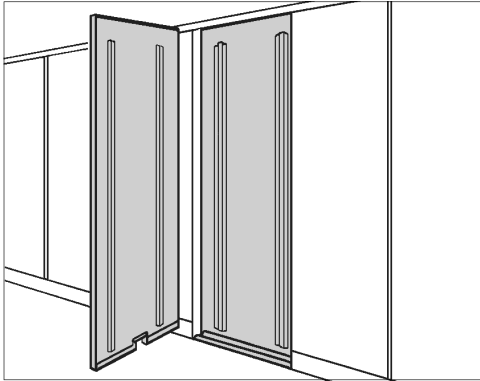

## PRODUCT INFORMATION

### Features:

- Demountable panel assembly has a groove at each end
- Constructed of two 5/8" gypsum face panels bonded to interlocking steel channels, resulting in a 16" to 23" wide non-combustible chaseway
- Side 2 of access panel has handle for separating the 2 panel halves.

**Note:** Locate Side 2 on inside of locked room to maintain security

- Class A fire rating
- Acoustical batts increase STC rating of wall panels

### Specifiers:

- Identify ceiling height and panel width.
- Identify acoustical batting option
- Identify surface finish for side 1 and side 2  
See appendix for vinyl styles and colors  
Specify "0000" for unfinished panels; panels must be field-finished
- For "CUS" option - supply 3.3 linear yards (min) per side

Ceiling Height & Panel Width		
108.23	9' x 23"	\$698
120.23	10' x 23"	\$752
108.24	9' x 24"	\$698
120.24	10' x 24"	\$752
108.29	9' x 29"	\$728
120.29	10' x 29"	\$790
108.30	9' x 30"	\$728
120.30	10' x 30"	\$790

Batting		
NA	none	+\$0
BX	acoustical batts	+\$58

Surface Finish Side 1 / Side 2		
First 2 digits specify series, last 2 specify color		
0000	unfinished	+\$0
CUS	customer material	+\$10
AD __	adobe	+\$38
----	price category 1	+\$91
----	price category 2	+\$101
----	price category 3	+\$115
----	price category 4	+\$149
----	price category 5	+\$206
----	price category 6	+\$302
----	price category 7	+\$388

i 2 2 1 3 . . . . .

. . . . .

. . . . . . . . . . .



# i2220 TONGUE-AND-GROOVE STANDARD GYPSUM PANEL

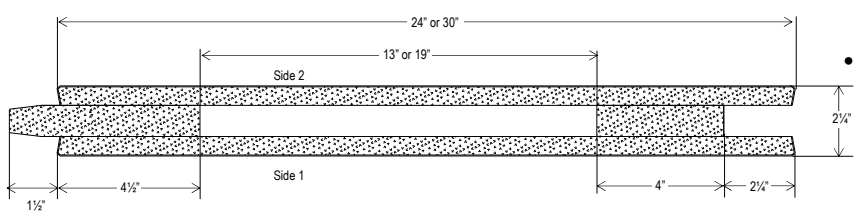
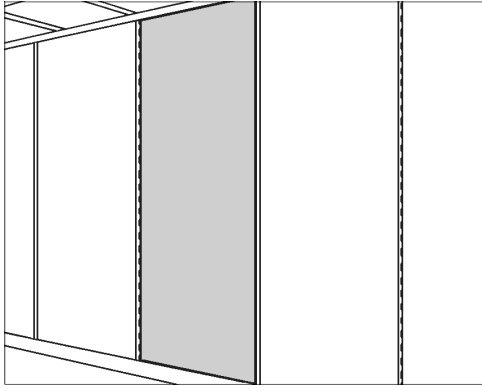

## PRODUCT INFORMATION

### Features:

- Unitized panel has a groove at one end and a tongue at the other
- Constructed of two 5/8" gypsum face panels laminated to two 1" gypsum studs, resulting in a 11" or 17"-wide, noncombustible chaseway
- Class A fire rating
- Acoustical batts increase STC rating of wall panels

### Specifiers:

- Identify ceiling height and panel width  
Specify each cut panel as the next-sized full panel
- Identify acoustical batting option
- Identify surface finish for side 1 and side 2  
Specify "0000" for unfinished panels; panels must be field-finished
- For "CUS" option - supply 3.3 linear yards (min) per side

Ceiling Height & Panel Width		
<b>108.24</b>	9' x 24"	\$294
<b>120.24</b>	10' x 24"	\$313
<b>108.30</b>	9' x 30"	\$404
<b>120.30</b>	10' x 30"	\$434

Batting		
<b>NA</b>	none	+\$0
<b>BX</b>	acoustical batts	+\$58

Surface Finish Side 1 / Side 2		
First 2 digits specify series, last 2 specify color		
<b>0000</b>	unfinished	+\$0
<b>CUS</b>	customer material	+\$10
<b>AD __</b>	adobe	+\$38
----	price category 1	+\$91
----	price category 2	+\$101
----	price category 3	+\$115
----	price category 4	+\$149
----	price category 5	+\$206
----	price category 6	+\$302
----	price category 7	+\$388

i | 2 | 2 | 2 | 0 | . | | | . | | |

| | |

| | | | | | | | | |

# i2220 TONGUE-AND-GROOVE CLERESTORY GYPSUM PANEL

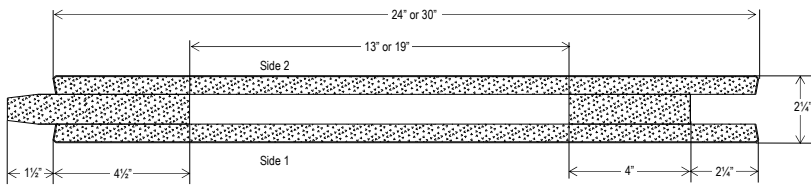
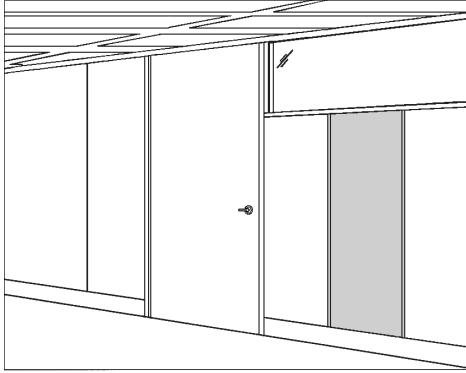

## PRODUCT INFORMATION

### Features:

- Unitized panel has a groove at one end and a tongue at the other
- Constructed of two 5/8" gypsum face panels laminated to two 1" gypsum studs
- Class A fire rating
- Panels are cut to a net height of 6'11". Other heights must be field cut or special ordered from your Regional Service Center
- Acoustical batts increase STC rating of wall panels

### Specifiers:

- Identify clerestory height and panel width  
Specify each cut panel as the next-sized full panel
- Identify acoustical batting option
- Identify surface finish for side 1 and side 2  
See appendix for vinyl styles and colors  
Specify "0000" for unfinished panels; panels must be field-finished
- For "CUS" option - supply 2.5 linear yards (min) per side

Clerestory Height & Panel Width		
24	7' x 24"	\$294
30	7' x 30"	\$404

Batting		
NA	none	+\$0
BX	acoustical batts	+\$58

Surface Finish Side 1 / Side 2		
First 2 digits specify series, last 2 specify color		
0000	unfinished	+\$0
CUS	customer material	+\$8
AD __	adobe	+\$29
----	price category 1	+\$68
----	price category 2	+\$76
----	price category 3	+\$8
----	price category 4	+\$112
----	price category 5	+\$155
----	price category 6	+\$227
----	price category 7	+\$290

i 2 2 2 0 . 8 4 .

# i2221 TONGUE-AND-GROOVE ELECTRICAL GYPSUM PANEL

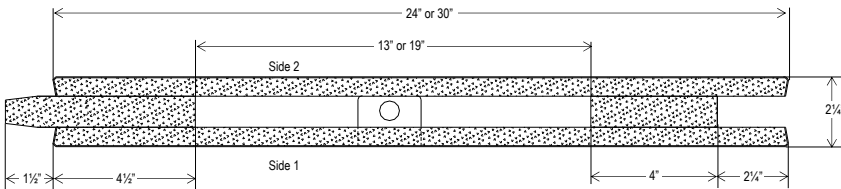
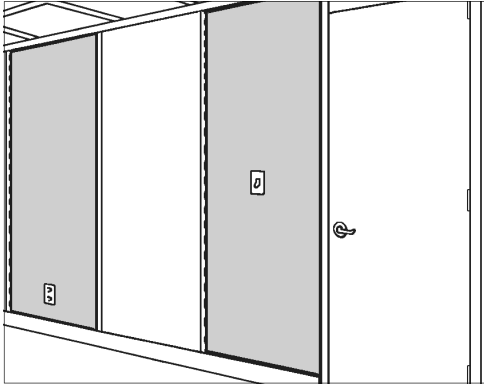

## PRODUCT INFORMATION

### Features:

- Unitized panel has a groove at one end & a tongue at the other
- Constructed of two 5/8" gypsum face panels laminated to two 1" gypsum studs
- Electrical components for specified options are pre-installed in the non-combustible 11" or 17"-wide chaseway
- Verify that electrical components supplied are approved for use by local building code and authorities
- Each electrical option, excluding "NA" and "E2", includes harness with UL listed connectors approx 3' from end to connect to power sources above the ceiling grid
- Class A fire rating
- Cover plates, switches, and outlets are not included and must be installed by a locally approved licensed electrician
- Acoustical batts increase STC rating of wall panels

### Specifiers:

- Identify ceiling height and panel width. Specify each cut panel as full panel
- Identify electrical option for side 1 and side 2
- Identify acoustical batting option
- Identify surface finish for side 1 and side 2. See appendix for vinyl styles and colors. Specify "0000" for unfinished panels; panels must be field-finished.
- For "CUS" option - supply 3.3 linear yards (min) per side

Ceiling Height & Panel Width		
108.24	9' x 24"	\$294
120.24	10' x 24"	\$313
108.30	9' x 30"	\$404
120.30	10' x 30"	\$434

Electrical Option Side 1 / Side 2		
NA	none	
E1	single duplex outlet, 120 volt	\$307
E2	single box with empty flex conduit for telecommunications	\$149
E3	combination of E1 and E2	\$455
E4	switch assembly, 120 volt	\$312
E5	switch assembly, 277 volt	\$312
E6	double duplex outlet	\$352
E7	combination of E2 and E6	\$457
E8	double switch assembly, 120 volt	\$568
E9	double switch assembly, 277 volt	\$568

Batting		
NA	none	+\$0
BX	acoustical batts	+\$58

Surface Finish Side 1 / Side 2		
First 2 digits specify series, last 2 specify color		
0000	unfinished	+\$0
CUS	customer material	+\$10
AD __	adobe	+\$38
----	price category 1	+\$91
----	price category 2	+\$101
----	price category 3	+\$115
----	price category 4	+\$149
----	price category 5	+\$206
----	price category 6	+\$302
----	price category 7	+\$388

i 2 2 2 1 . . . . .

. . . . .

. . . . .

**i2221 TONGUE-AND-GROOVE MAKE-UP GYPSUM PANEL**

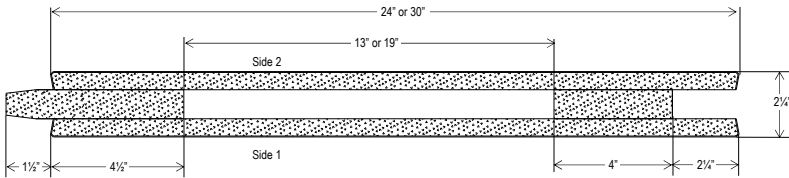
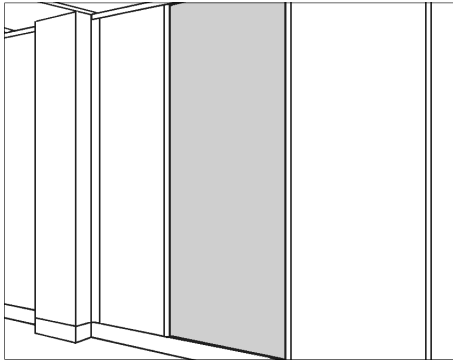

**PRODUCT INFORMATION**

**Features:**

- Panel consists of two face sheets and two coreboards
- Field-assembled to allow for the finishing off of a wall run between two fixed points
- Adhesive required to assemble make-up panel ordered separately
- Acoustical batts increase STC rating of wall panels

**Specifiers:**

- Identify ceiling height and panel width
- Identify acoustical batting option
- Identify surface finish for side 1 and side 2  
See appendix for vinyl styles and colors  
Specify "0000" for unfinished panels; panels must be field-finished
- For "CUS" option - supply 3.3 linear yards (min) per side

Ceiling Height & Panel Width		
<b>108.24</b>	9' x 24"	\$286
<b>120.24</b>	10' x 24"	\$305
<b>108.30</b>	9' x 30"	\$396
<b>120.30</b>	10' x 30"	\$426

Batting		
<b>NA</b>	none	+\$0
<b>BX</b>	acoustical batts	+\$58

Surface Finish Side 1 / Side 2		
First 2 digits specify series, last 2 specify color		
<b>0000</b>	unfinished	+\$0
<b>CUS</b>	customer material	+\$10
<b>AD __</b>	adobe	+\$38
----	price category 1	+\$91
----	price category 2	+\$101
----	price category 3	+\$115
----	price category 4	+\$149
----	price category 5	+\$206
----	price category 6	+\$302
----	price category 7	+\$388

i 2 2 2 2 . . . . .

. . .

. . . . . . . . . .

# i2222 TONGUE-AND-GROOVE MAKE-UP GYPSUM PANEL

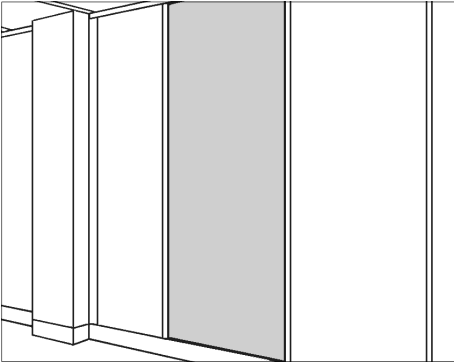

## PRODUCT INFORMATION

### Features:

- Panel consists of two face sheets and two coreboards
- Field-assembled to allow for the finishing off of a wall run between two fixed points
- Adhesive required to assemble make-up panel ordered separately
- Acoustical batts increase STC rating of wall panels

### Specifiers:

- Identify ceiling height and panel width
- Identify acoustical batting option
- Identify surface finish for side 1 and side 2  
See appendix for vinyl styles and colors  
Specify "0000" for unfinished panels; panels must be field-finished
- For "CUS" option - supply 3.3 linear yards (min) per side

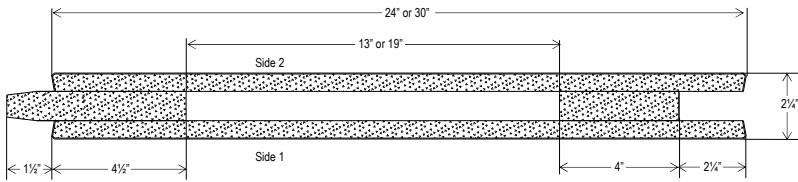

Ceiling Height & Panel Width		
108.24	9' x 24"	\$286
120.24	10' x 24"	\$305
108.30	9' x 30"	\$396
120.30	10' x 30"	\$426

Batting		
NA	none	+\$0
BX	acoustical batts	+\$58

Surface Finish Side 1 / Side 2		
First 2 digits specify series, last 2 specify color		
0000	unfinished	+\$0
CUS	customer material	+\$10
AD __	adobe	+\$38
----	price category 1	+\$91
----	price category 2	+\$101
----	price category 3	+\$115
----	price category 4	+\$149
----	price category 5	+\$206
----	price category 6	+\$302
----	price category 7	+\$388

i	2	2	2	2	.		.		
---	---	---	---	---	---	--	---	--	--

--	--	--

--	--	--	--	--	--	--	--

# i2240 PANEL JACKS

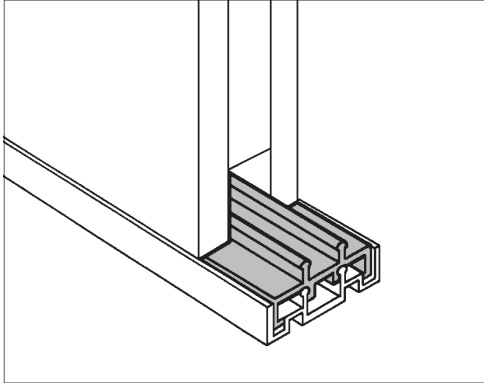

## PRODUCT INFORMATION

### Features:

- 6"- long extruded aluminum jack snaps onto the Floor Runner (i2120 or i2122) and elevates gypsum panels in 1/2" increments
- Package contains 48

**Note:** Use 2 jacks for each panel  
May stack maximum of 3 jacks for total additional height of 1 1/2"

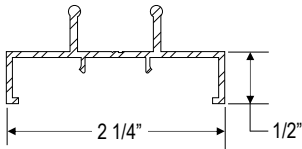

Product Number	
i2240	\$259

i | 2 | 2 | 4 | 0 | . |

# i2245 SADDLE EXTENDER

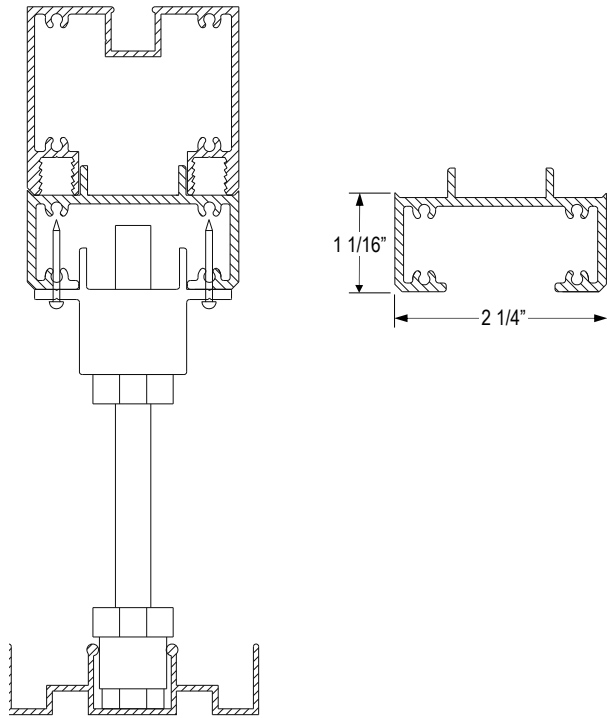

## PRODUCT INFORMATION

### Features:

- Aluminum filler extends aluminum-framed panel by 1"
- Mounts on top or bottom rail of panel
- Comes in 12' lengths

### Specifier:

- Identify trim finish

Product Number		Trim Finish
i 2245	\$256	<p><b>B3B2B0</b> alum</p> <p><b>9FA1A0</b> anodized</p> <p><b>EDE9E0</b> base white</p> <p><b>C0B7A8</b> desert storm</p> <p><b>89989D</b> epoxy blue</p> <p><b>4F4546</b> espresso</p> <p><b>918D81</b> glimmer bronze</p> <p><b>48494D</b> graphite</p> <p><b>F3FDFF</b> ice white</p> <p><b>323836</b> matte slate</p> <p><b>B8AEA3</b> metallic stone</p> <p><b>40403F</b> midnight black</p> <p><b>201920</b> onyx</p> <p><b>605746</b> rust bronze</p> <p><b>636D6F</b> space grey</p> <p><b>EAEBE6</b> stone white</p> <p><b>A49E9E</b> warm grey</p>

i 2 2 4 5 .

□ □

**i2270 MODULAR SINGLE GLASS PANEL (1/4" GLASS)**  
**i2272 MODULAR SINGLE GLASS PANEL (3/8" OR 1/2" GLASS)**

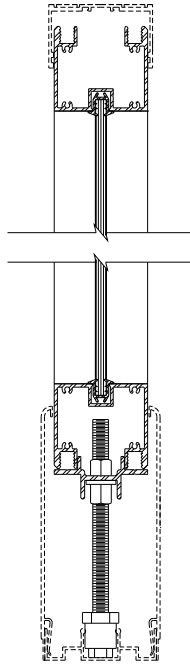
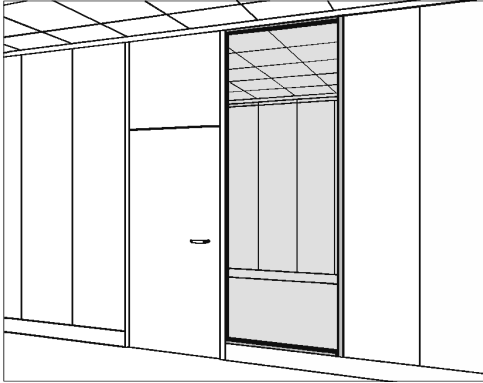

**PRODUCT INFORMATION**

**Features:**

- Inserts into ceiling and floor runners (i2110, i2120, i2122, i2124)
- Leveling feet integrated into panel
- Panel adjusts from +2" to -5/8" from ceiling height selected
- Modular connection on both ends
- Pre-glazed
- Base electrical system requires 6" base compatible panels

**Specifiers:**

- Identify ceiling height
  - Identify panel width
  - Identify trim finish
  - Identify base height
  - Identify glass finish
- See appendix for 'FX' custom applied film options

Product Number	Ceiling Height	Panel Width	Trim Finish	Base Height	Glass Finish
<b>i 2270</b> Modular Single Glass Panel (1/4" Glass)	96 8'0" \$1244	18 18" +\$0 24 24" +\$131 30 30" +\$264 36 36" +\$395 42 42" +\$527 48 48" +\$660	B3B2B0 alum	00 No Base 04 4" 06 6"	<b>e2270</b> GR 1/4" clear temp +\$0 GP 1/4" pattern 62 +\$269 GS 1/4" laminated +\$1312 GG 1/4" frosted +\$1834 GL 1/4" white lam +\$2042
	97 8'1" \$1244		9FA1A0 anodized		
	98 8'2" \$1244		EDE9E0 base white		
	99 8'3" \$1244		C0B7A8 desert storm		
	100 8'4" \$1244		89989D epoxy blue		
	101 8'5" \$1244		4F4546 espresso		
	102 8'6" \$1244		918D81 glimmer bronze		
	103 8'7" \$1244		48494D graphite		
	104 8'8" \$1244		F3FDFF ice white		
	105 8'9" \$1244		323836 matte slate		
	106 8'10" \$1244		B8AEA3 metallic stone		
	107 8'11" \$1244		40403F midnight black		
<b>i 2272</b> Modular Single Glass Panel (3/8" or 1/2" Glass)	108 9'0" \$1244	201920 onyx	00 No Base 04 4" 06 6"	<b>e2272</b> GW 3/8" clear temp +\$600 GY 3/8" laminated +\$2134 GZ 3/8" frosted +\$2798 GI 3/8" white lam +\$3913	
	109 9'1" \$1283	60574F rust bronze			
	110 9'2" \$1283	636D6F space grey			
	111 9'3" \$1283	EAEBE6 stone white			
	112 9'4" \$1283	A49E9E warm grey			
	113 9'5" \$1283				
	114 9'6" \$1283				
	115 9'7" \$1283				
	116 9'8" \$1283				
	117 9'9" \$1283				
	118 9'10" \$1283				
	119 9'11" \$1283				
120 10'0" \$1283					
					GC 1/2" clear temp +\$1207 GJ 1/2" laminated +\$3160 GU 1/2" frosted +\$3769 GV 1/2" white lam +\$4351
					GX custom or CUS FX custom applied film

i 2 2 7 .



**i2271 MODULAR MULTI-LITE GLASS PANEL (1/4" GLASS)**

**i2273 MODULAR MULTI-LITE GLASS PANEL (3/8" OR 1/2" GLASS)**

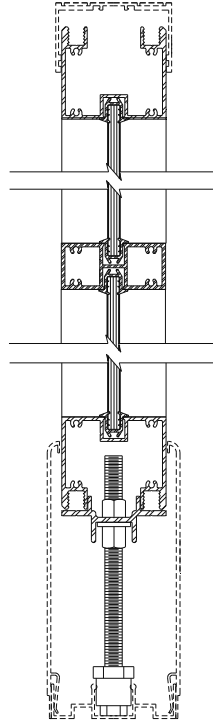
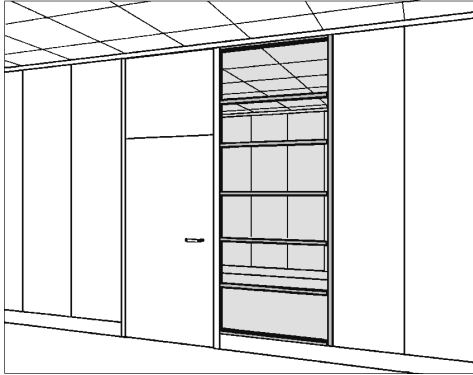

**PRODUCT INFORMATION**

**Features:**

- Standard 5 muntin-6 lite panel for 8 and 9 foot ceiling height, Standard 6 muntin-7 lite panel for 10 foot ceiling height (for custom panels see page 34)
- Inserts into ceiling and floor runners (i2110, i2120, i2122, i2124)
- Leveling feet integrated into panel
- Modular connection on both ends
- Pre-glazed
- Base electrical system requires 6" base compatible panels
- Top lite varies in height according to ceiling height, standard lites are 16" on center

**Specifiers:**

- Identify ceiling height
  - Identify panel width
  - Identify trim finish
  - Identify base height
  - Identify glass finish
- See appendix for "FX" custom applied film options

Product Number	Ceiling Height	Panel Width	Trim Finish	Base Height	Glass Finish
<b>i2271</b> Modular Multi-lite Glass Panel (1/4" Glass)	96 8'0" \$1770 97 8'1" \$1770 98 8'2" \$1770 99 8'3" \$1770 100 8'4" \$1770 101 8'5" \$1770 102 8'6" \$1770 103 8'7" \$1770 104 8'8" \$1770 105 8'9" \$1770 106 8'10" \$1770 107 8'11" \$1770 108 9'0" \$1770	18 18" +\$0 24 24" +\$194 30 30" +\$358 36 36" +\$536 42 42" +\$715 48 48" +\$896	<b>B3B2B0</b> alum <b>9FA1A0</b> anodized <b>EDE9E0</b> base white <b>C0B7A8</b> desert storm <b>89989D</b> epoxy blue <b>4F4546</b> espresso <b>918D81</b> glimmer bronze <b>48494D</b> graphite <b>F3FDFF</b> ice white <b>323836</b> matte slate <b>B8AEA3</b> metallic stone <b>40403F</b> midnight black <b>201920</b> onyx <b>605746</b> rust bronze <b>636D6F</b> space grey <b>EAEBE6</b> stone white <b>A49E9E</b> warm grey	<b>00</b> No Base <b>04</b> 4" <b>06</b> 6"	<b>e2271</b> <b>GR</b> 1/4" clear temp +\$0 <b>GP</b> 1/4" pattern 62 +\$269 <b>GS</b> 1/4" laminated +\$1312 <b>GG</b> 1/4" frosted +\$1834 <b>GL</b> 1/4" white lam +\$2042  <b>e2272</b> <b>GW</b> 3/8" clear temp +\$600 <b>GY</b> 3/8" laminated +\$2134 <b>GZ</b> 3/8" frosted +\$2798 <b>GI</b> 3/8" white lam +\$3913  <b>GC</b> 1/2" clear temp +\$1207 <b>GJ</b> 1/2" laminated +\$3160 <b>GU</b> 1/2" frosted +\$3769 <b>GV</b> 1/2" white lam +\$4351  <b>GX</b> custom or CUS <b>FX</b> custom applied film

i 2 2 7 .

# i2274 FRAMELESS GLASS PANELS (BUTT GLAZING)

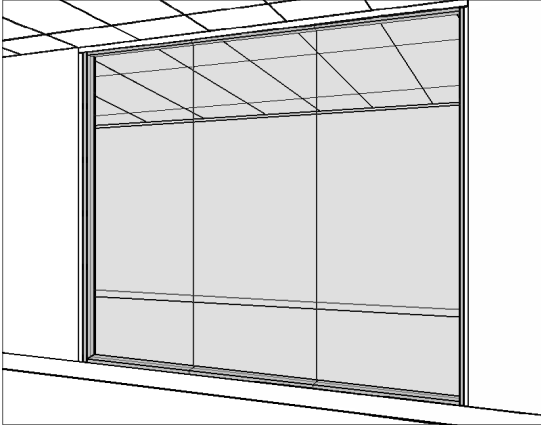

## PRODUCT INFORMATION

### Features:

- Inserts into ceiling and floor runners (i2110, i2120, i2122, e2124)
- Leveling feet integrated into panel (except NO Base Option)  
Panel adjusts from +2" to -5/8" from ceiling height selected
- Modular connection on both ends
- Pre-glazed with 3/8" or 1/2" Glass  
Ceiling Height 96" and over **MUST** use 1/2" Glass
- Base electrical system requires 6" base compatible panels
- Uses standard clear vinyl 'H' connector at butt glaze joints  
Wet glazing (silicone) may be contracted separately

### Specifiers:

- Identify ceiling height
  - Identify panel width
  - Identify frame option
  - Identify trim finish
  - Identify base height
  - Identify glass finish
- See appendix for 'FX' custom applied film options

Ceiling Height		
<b>3/8" or 1/2" Glass</b>		
84	7'0"	\$1100
85	7'1"	\$1100
86	7'2"	\$1100
87	7'3"	\$1100
88	7'4"	\$1100
89	7'5"	\$1100
90	7'6"	\$1100
91	7'7"	\$1100
92	7'8"	\$1100
93	7'9"	\$1100
94	7'10"	\$1100
95	7'11"	\$1100
96	8'0"	\$1100
<b>1/2" Glass</b>		
97	8'1"	\$1100
98	8'2"	\$1100
99	8'3"	\$1100
100	8'4"	\$1100
101	8'5"	\$1100
102	8'6"	\$1100
103	8'7"	\$1100
104	8'8"	\$1100
105	8'9"	\$1100
106	8'10"	\$1100
107	8'11"	\$1100
108	9'0"	\$1100
109	9'1"	\$1225
110	9'2"	\$1225
111	9'3"	\$1225
112	9'4"	\$1225
113	9'5"	\$1225
114	9'6"	\$1225
115	9'7"	\$1225
116	9'8"	\$1225
117	9'9"	\$1225
118	9'10"	\$1225
119	9'11"	\$1225
120	10'0"	\$1225

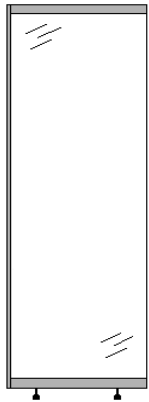

**FR**  
No Frame Right

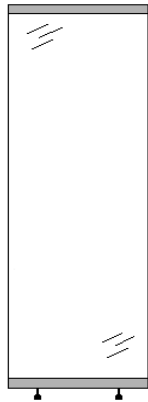

**FB**  
No Frame Both Sides

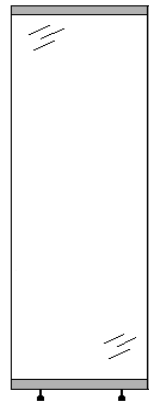

**FL**  
No Frame Left

Panel Width		
18	18"	+\$0
24	24"	+\$187
30	30"	+\$313
36	36"	+\$449
42	42"	+\$564
48	48"	+\$689

Frame Option	
<b>FR</b>	No Frame Right
<b>FL</b>	No Frame Left
<b>FB</b>	No Frame Both Sides

Trim Finish	
<b>B3B2B0</b>	alum
<b>9FA1A0</b>	anodized
<b>EDE9E0</b>	base white
<b>C0B7A8</b>	desert storm
<b>89989D</b>	epoxy blue
<b>4F4546</b>	espresso
<b>918D81</b>	glimmer bronze
<b>48494D</b>	graphite
<b>F3FDFF</b>	ice white
<b>323836</b>	matte slate
<b>B8AEA3</b>	metallic stone
<b>40403F</b>	midnight black
<b>201920</b>	onyx
<b>605746</b>	rust bronze
<b>636D6F</b>	space grey
<b>EAEBE6</b>	stone white
<b>A49E9E</b>	warm grey

Base Height	
<b>00</b>	No Base
<b>04</b>	4"
<b>06</b>	6"

Glass Finish		
<b>GW</b>	3/8" clear temp	+\$600
<b>GY</b>	3/8" laminated	+\$2134
<b>GZ</b>	3/8" frosted	+\$2798
<b>GI</b>	3/8" white lam	+\$3913
<b>GC</b>	1/2" clear temp	+\$1207
<b>GJ</b>	1/2" laminated	+\$3160
<b>GU</b>	1/2" frosted	+\$3769
<b>GV</b>	1/2" white lam	+\$4351
<b>GX</b>	custom or CUS	
<b>FX</b>	custom applied film	

i 2 2 7 4 . . . . .

- i2275 MODULAR PANEL FRAME (1/4")
- i2276 MODULAR PANEL FRAME (1/4"), SYSTEMS
- i2277 MODULAR PANEL FRAME (3/8" OR 1/2")
- i2278 MODULAR PANEL FRAME (3/8" OR 1/2"), SYSTEMS

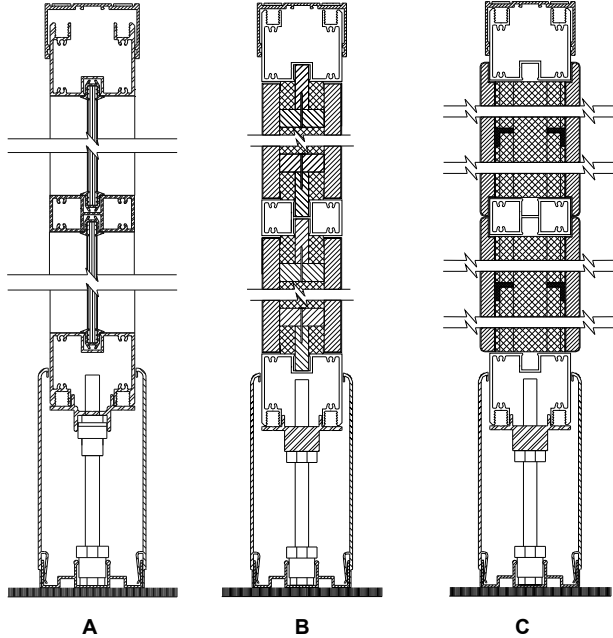

Shown with: **A** Glass Inserts (i2282 & i2286)  
**B** Hard Surface Inserts (i2291)  
**C** Hard Surface Outserts (i2296)

**PRODUCT INFORMATION**

**Features:**

- Inserts into ceiling and floor runners (i2110, i2120, i2122, i2124)
- Aluminum panel frame accepts non-standard panel details:
  1. Selection & location of any combination of finishes
  2. Custom layout of lites & vertical location of horizontal muntins
  3. Custom finishes
- Inserts (i2282, i2283, i2284, i2285, i2286, i2287, i2288 and i2289) and Outserts (i2291, i2292, i2293, i2296, i2297, i2298) are ordered separately
- Ceiling runners, floor runners, base trim and 8-wire electrical system ordered separately

**Specifiers:**

- Requires use of *Modular Panel Frame Worksheet* (see appendix)
- Identify product number
- Identify correct ceiling height(s) - see PIN
- Use modular panel widths as required by layout - see PIN
- Identify aluminum trim finish color
- Identify number of horizontal muntins required by layout  
 Note: Each muntin adds 1 lite  
 ie. 1 muntin creates 2 lites or openings  
 2 muntins create 3 lites or openings  
 3 muntins create 4 lites or openings
- Identify base height

Product Number	Ceiling Height	Panel Width	Trim Finish	Horizontal Muntins	Base Height
<b>i 2275</b> 1/4" Modular Panel Frame	96 8'0" \$928 97 8'1" \$928 98 8'2" \$928 99 8'3" \$928 100 8'4" \$928 101 8'5" \$928 102 8'6" \$928 103 8'7" \$928	18 18" +\$0 24 24" +\$26 30 30" +\$53 36 36" +\$79 42 42" +\$106 48 48" +\$133	B3B2B0 alum 9FA1A0 anodized EDE9E0 base white C0B7A8 desert storm 89989D epoxy blue 4F4546 espresso 918D81 glimmer bronze 48494D graphite F3FDFF ice white 323836 matte slate B8AEA3 metallic stone 40403F midnight black 201920 onyx 605746 rust bronze 636D6F space grey EAEBE6 stone white A49E9E warm grey	NA no muntins +\$0 01 1 muntin +\$102 02 2 muntins +\$204 03 3 muntins +\$307 04 4 muntins +\$409 05 5 muntins +\$511 06 6 muntins +\$613 07 7 muntins +\$715 08 8 muntins +\$817 09 9 muntins +\$920	00 No Base 04 4" 06 6"
<b>i 2276</b> 1/4" Modular Panel Frame, Systems	104 8'8" \$928 105 8'9" \$928 106 8'10" \$928 107 8'11" \$928 108 9'0" \$928	<b>Systems Panel Width</b> 23 23" +\$26 29 29" +\$53 35 35" +\$79 41 41" +\$106 47 47" +\$133			
<b>i 2277</b> 3/8" or 1/2" Modular Panel Frame	109 9'1" \$966 110 9'2" \$966 111 9'3" \$966 112 9'4" \$966 113 9'5" \$966 114 9'6" \$966 115 9'7" \$966 116 9'8" \$966 117 9'9" \$966 118 9'10" \$966 119 9'11" \$966 120 10'0" \$966				
<b>i 2278</b> 3/8" or 1/2" Modular Panel Frame, Systems					

# i2280 TRANSM CLERESTORY GLASS, 1' - 2'11" HEIGHT

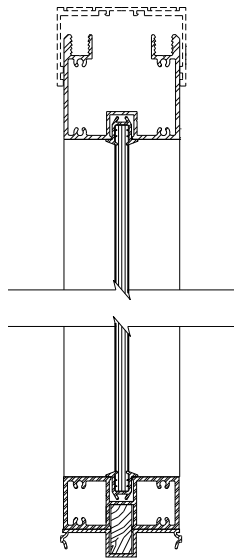
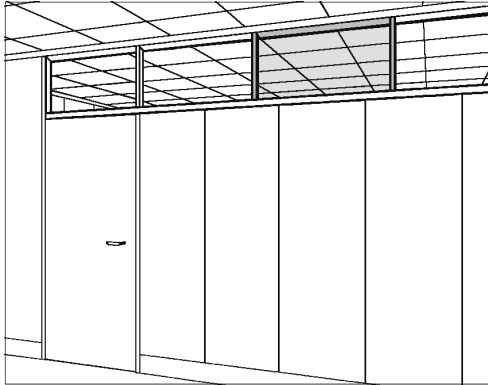

## PRODUCT INFORMATION

### Features:

- Inserts into Ceiling Runner and (i2110), Compound Connector 180 (i2344) or top of Partial Height Door Frame (i2514, i2515)
- Pre-glazed
- Ceiling runner, transitional connector, and door frame ordered separately

**Note:** Order height according to clear opening between ceiling runner and transitional component

Example: A 9' ceiling height with a 7' partial height door frame requires a 21" unit:  $108'' - 84'' - 1\frac{1}{2}'' - 1\frac{1}{2}'' = 21''$

### Specifiers:

- Identify glass height
  - Identify unit width
  - Identify trim finish
  - Identify glass finish
- See appendix for "FX" custom applied film options

Glass Height		
12	1'0"	\$642
13	1'1"	\$642
14	1'2"	\$642
15	1'3"	\$642
16	1'4"	\$642
17	1'5"	\$642
18	1'6"	\$642
19	1'7"	\$642
20	1'8"	\$642
21	1'9"	\$642
22	1'10"	\$642
23	1'11"	\$642
24	2'0"	\$722
25	2'1"	\$722
26	2'2"	\$722
27	2'3"	\$722
28	2'4"	\$722
29	2'5"	\$722
30	2'6"	\$722
31	2'7"	\$722
32	2'8"	\$722
33	2'9"	\$722
34	2'10"	\$722
35	2'11"	\$722

Unit Width for Heights 1'0" to 1'11"		
24	24"	+\$0
30	30"	+\$53
36	36"	+\$107
42	42"	+\$145
48	48"	+\$199
60	60"	+\$308
72	72"	+\$406
85	85"	+\$506
Unit Width for Heights 2'0" to 2'11"		
24	24"	+\$0
30	30"	+\$66
36	36"	+\$131
42	42"	+\$180
48	48"	+\$246
60	60"	+\$376
72	72"	+\$496
85	85"	+\$618

Trim Finish	
B3B2B0	alum
9FA1A0	anodized
EDE9E0	base white
C0B7A8	desert storm
89989D	epoxy blue
4F4546	espresso
918D81	glimmer bronze
48494D	graphite
F3FDFF	ice white
323836	matte slate
B8AEA3	metallic stone
40403F	midnight black
201920	onyx
605746	rust bronze
636D6F	space grey
EAEBE6	stone white
A49E9E	warm grey

		Glass Finish	
		for Heights 1'0" to 1'11"	for Heights 2'0" to 2'11"
GR	1/4" clear temp	+\$0	+0
GP	1/4" pattern 62	+\$52	+\$102
GS	1/4" laminated	+\$250	+\$500
GG	1/4" frosted	+\$352	+\$704
GL	1/4" white lam	+\$390	+\$778
GW	3/8" clear temp	+\$115	+\$230
GY	3/8" laminated	+\$412	+\$824
GZ	3/8" frosted	+\$536	+\$1073
GI	3/8" white lam	+\$748	+\$1495
GC	1/2" clear temp	+\$203	+\$460
GJ	1/2" laminated	+\$604	+\$1207
GU	1/2" frosted	+\$719	+\$1438
GV	1/2" white lam	+\$830	+\$1661
GX	custom or CUS		
FX	custom applied film		

i 2 2 8 0 .

# i2280 TRANSOM CLERESTORY GLASS, 3'-5' HEIGHT

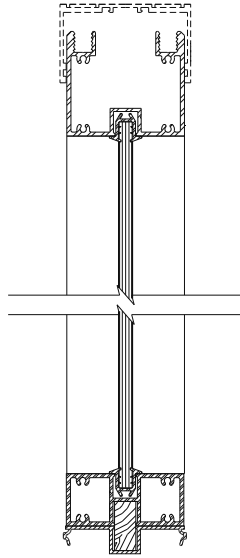
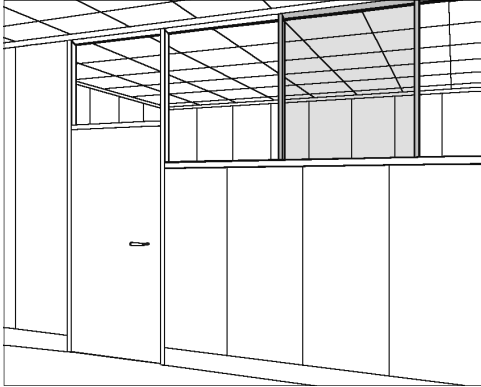

## PRODUCT INFORMATION

### Features:

- Inserts into Ceiling Runner and (i2110), Compound Connector 180 (i2344) or top of Partial Height Door Frame (i2514, i2515)
- Pre-glazed
- Ceiling runner, transitional connector, and door frame ordered separately

**Note:** Order height according to clear opening between ceiling runner and transitional component

Example: A 9' ceiling height with a 7' partial height door frame requires a 21" unit:  $108'' - 84'' - 1\frac{1}{2}'' - 1\frac{1}{2}'' = 21''$

### Specifiers:

- Identify glass height
  - Identify unit width
  - Identify trim finish
- Identify glass finish "FX" custom applied film options

Glass Height		
36	3'0"	\$803
37	3'1"	\$803
38	3'2"	\$803
39	3'3"	\$803
40	3'4"	\$803
41	3'5"	\$803
42	3'6"	\$803
43	3'7"	\$803
44	3'8"	\$803
45	3'9"	\$803
46	3'10"	\$803
47	3'11"	\$803
48	4'0"	\$884
49	4'1"	\$884
50	4'2"	\$884
51	4'3"	\$884
52	4'4"	\$884
53	4'5"	\$884
54	4'6"	\$884
55	4'7"	\$884
56	4'8"	\$884
57	4'9"	\$884
58	4'10"	\$884
59	4'11"	\$884
60	5'0"	\$884

Unit Width for Heights 3'0" to 3'11"		
24	24"	+\$0
30	30"	+\$77
36	36"	+\$152
42	42"	+\$208
48	48"	+\$277
60	60"	+\$415
72	72"	+\$553
85	85"	+\$692
Unit Width for Heights 4'0" to 5'0"		
24	24"	+\$0
30	30"	+\$86
36	36"	+\$174
42	42"	+\$263
48	48"	+\$349
60	60"	+\$523
72	72"	+\$697
85	85"	+\$871

Trim Finish	
B3B2B0	alum
9FA1A0	anodized
EDE9E0	base white
C0B7A8	desert storm
89989D	epoxy blue
4F4546	espresso
918D81	glimmer bronze
48494D	graphite
F3FDFF	ice white
323836	matte slate
B8AEA3	metallic stone
40403F	midnight black
201920	onyx
605746	rust bronze
636D6F	space grey
EAEBE6	stone white
A49E9E	warm grey

	Glass Finish	
	for Heights 3'0" to 3'11"	for Heights 4'0" to 5'0"
GR	1/4" clear temp	+\$0
GP	1/4" pattern62	+\$154
GS	1/4" laminated	+\$749
GG	1/4" frosted	+\$1056
GL	1/4" white lam	+\$1168
GW	3/8" clear temp	+\$344
GY	3/8" laminated	+\$1236
GZ	3/8" frosted	+\$1610
GI	3/8" white lam	+\$2243
GC	1/2" clear temp	+\$690
GJ	1/2" laminated	+\$1811
GU	1/2" frosted	+\$2156
GV	1/2" white lam	+\$2491
GX	custom or CUS	
FX	custom applied film	

i 2 2 8 0 .

# i2281 TRANSOM CLERESTORY MULTI-LITE, 2'1" - 5' HEIGHT

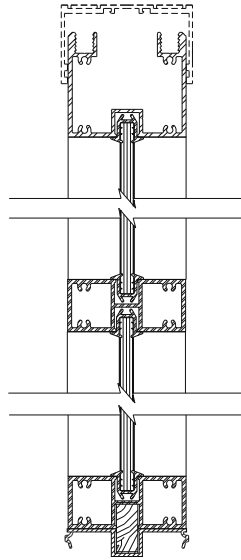
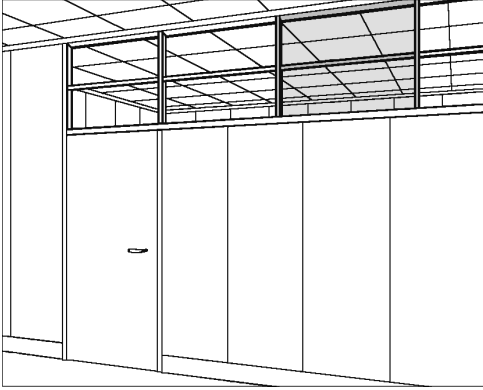

## PRODUCT INFORMATION

### Features:

- Inserts into Ceiling Runner and (i2110), Compound Connector 180 (i2344) or top of Partial Height Door Frame (i2514, i2515)
- Pre-glazed
- Ceiling runner, transitional connector, and door frame ordered separately
- Top lite varies in height according to ceiling height, standard lites are 16" on center
- For combination of glazing finishes or non-standard lite layout, specify "GX" glazing finish and use the Custom Transom Clerestory Multi-Lite Worksheet for i2281 (see appendix)

**Note:** Order height according to clear opening between ceiling runner and transitional component

Example: A 9' ceiling height with a 7' partial height door frame requires a 21" unit:  $108"-84"-1\frac{1}{2}"-1\frac{1}{2}" = 21"$

### Specifiers:

- Identify multi-lite height
  - Identify unit width
  - Identify trim finish
  - Identify glass finish
- See appendix for "FX" custom applied film options

Multi-lite Height		
25	2'1"	\$894
26	2'2"	\$894
27	2'3"	\$894
28	2'4"	\$894
29	2'5"	\$894
30	2'6"	\$894
31	2'7"	\$894
32	2'8"	\$894
33	2'9"	\$894
34	2'10"	\$894
35	2'11"	\$894
36	3'0"	\$894
37	3'1"	\$894
38	3'2"	\$894
39	3'3"	\$894
40	3'4"	\$894
41	3'5"	\$1075
42	3'6"	\$1075
43	3'7"	\$1075
44	3'8"	\$1075
45	3'9"	\$1075
46	3'10"	\$1075
47	3'11"	\$1075
48	4'0"	\$1075
49	4'1"	\$1075
50	4'2"	\$1075
51	4'3"	\$1075
52	4'4"	\$1075
53	4'5"	\$1075
54	4'6"	\$1075
55	4'7"	\$1075
56	4'8"	\$1075
57	4'9"	\$1075
58	4'10"	\$1075
59	4'11"	\$1075
60	5'0"	\$1075

Unit Width for Heights 2'1" to 3'4"		
24	24"	+\$0
30	30"	+\$80
36	36"	+\$160
42	42"	+\$240
48	48"	+\$322
60	60"	+\$482
72	72"	+\$644
85	85"	+\$805
Unit Width for Heights 3'5" to 5'0"		
24	24"	+\$0
30	30"	+\$108
36	36"	+\$217
42	42"	+\$325
48	48"	+\$434
60	60"	+\$652
72	72"	+\$869
85	85"	+\$1086

Trim Finish	
B3B2B0	alum
9FA1A0	anodized
EDE9E0	base white
C0B7A8	desert storm
89989D	epoxy blue
4F4546	espresso
918D81	glimmer bronze
48494D	graphite
F3FDFF	ice white
323836	matte slate
B8AEA3	metallic stone
40403F	midnight black
201920	onyx
605746	rust bronze
636D6F	space grey
EAEBE6	stone white
A49E9E	warm grey

	Glass Finish	
	for Heights 2'1" to 3'4"	for Heights 3'5" to 5'0"
GR	1/4" clear temp	+\$0
GP	1/4" pattern62	+\$154
GS	1/4" laminated	+\$749
GG	1/4" frosted	+\$1056
GL	1/4" white lam	+\$1168
GW	3/8" clear temp	+\$344
GY	3/8" laminated	+\$1811
GZ	3/8" frosted	+\$2156
GI	3/8" white lam	+\$2491
GC	1/2" clear temp	+\$690
GJ	1/2" laminated	+\$1811
GU	1/2" frosted	+\$2156
GV	1/2" white lam	+\$2491
GX	custom or CUS	
FX	custom applied film	

i | 2 | 2 | 8 | 1 | . | | |

| | |

| | |

| | |

**i2282 STANDARD GLASS INSERT 8-80"**

**i2286 SYSTEMS GLASS INSERT 8-80"**

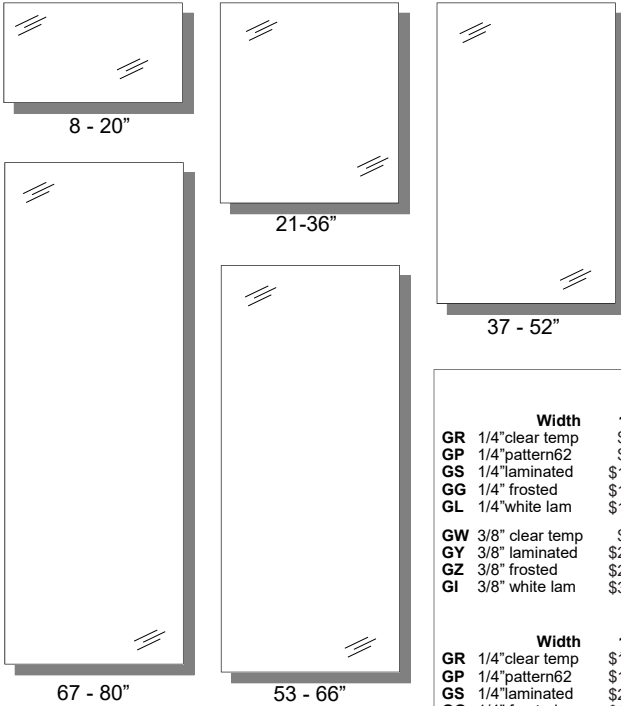

**PRODUCT INFORMATION**

**Features:**

- Safety glass used in a Modular Panel Frame (i2275, i2276, i2277, or i2278) which is ordered separately - comes pre-installed

- Use when ordering nonstandard panel details

**Specifiers:**

- Requires use of *Modular Panel Frame Worksheet* (see appendix)
- Identify product number
- Identify glass height
- Use modular panel widths as required by layout using same panel width as Modular Panel Frame (i2275, i2276, i2277 or i2278)
- Identify glass finish. See appendix for "FX" custom applied film options

Product Number	Glass Height	Panel Width
<b>i2282</b> Standard	16 16"	18 18"
	32 32"	24 24"
	48 48"	30 30"
	64 64"	36 36"
<b>i2286</b> Systems	80 80"	42 42"
	CC 8 - 15"	48 48"
	17 - 31"	
	33 - 47"	
	49 - 63"	<b>Systems</b>
	65 - 79"	<b>Panel Width</b>
		23 23"
		29 29"
		35 35"
		41 41"
		47 47"

Glass Finish for Lite 8"-20"						Glass Finish for Lite 8"-20"									
	Width	18"	24"	30"	36"	42"	48"		Width	18"	24"	30"	36"	42"	48"
<b>GR</b>	1/4"clear temp	\$53	\$71	\$88	\$106	\$122	\$140	<b>GC</b>	1/2" clear temp	\$139	\$185	\$232	\$278	\$324	\$371
<b>GP</b>	1/4"pattern62	\$72	\$96	\$120	\$144	\$168	\$192	<b>GJ</b>	1/2" laminated	\$278	\$372	\$439	\$556	\$650	\$743
<b>GS</b>	1/4"laminated	\$146	\$194	\$245	\$293	\$342	\$390	<b>GU</b>	1/2" frosted	\$311	\$430	\$536	\$643	\$751	\$858
<b>GG</b>	1/4" frosted	\$184	\$246	\$307	\$367	\$428	\$488	<b>GV</b>	1/2" white lam	\$364	\$486	\$605	\$727	\$848	\$970
<b>GL</b>	1/4"white lam	\$198	\$265	\$331	\$397	\$463	\$529								
<b>GW</b>	3/8" clear temp	\$96	\$127	\$160	\$192	\$223	\$254								
<b>GY</b>	3/8" laminated	\$206	\$276	\$342	\$410	\$479	\$546								
<b>GZ</b>	3/8" frosted	\$252	\$338	\$421	\$506	\$589	\$674								
<b>GI</b>	3/8" white lam	\$332	\$444	\$554	\$665	\$775	\$887								
Glass Finish for Lite 21"- 36"						Glass Finish for Lite 21"- 36"									
	Width	18"	24"	30"	36"	42"	48"		Width	18"	24"	30"	36"	42"	48"
<b>GR</b>	1/4"clear temp	\$106	\$140	\$175	\$211	\$246	\$281	<b>GC</b>	1/2" clear temp	\$278	\$371	\$463	\$556	\$648	\$742
<b>GP</b>	1/4"pattern62	\$144	\$192	\$240	\$288	\$336	\$383	<b>GJ</b>	1/2" laminated	\$558	\$744	\$928	\$1114	\$1298	\$1483
<b>GS</b>	1/4"laminated	\$293	\$390	\$488	\$586	\$684	\$781	<b>GU</b>	1/2" frosted	\$643	\$859	\$1073	\$1285	\$1502	\$1717
<b>GG</b>	1/4" frosted	\$367	\$492	\$612	\$734	\$858	\$979	<b>GV</b>	1/2" white lam	\$727	\$971	\$1212	\$1453	\$1697	\$1938
<b>GL</b>	1/4"white lam	\$397	\$530	\$661	\$794	\$926	\$1058								
<b>GW</b>	3/8" clear temp	\$192	\$256	\$318	\$383	\$445	\$510								
<b>GY</b>	3/8" laminated	\$410	\$553	\$684	\$822	\$956	\$1094								
<b>GZ</b>	3/8" frosted	\$506	\$677	\$841	\$1012	\$1178	\$1346								
<b>GI</b>	3/8" white lam	\$665	\$888	\$1106	\$1328	\$1550	\$1771								
Glass Finish for Lite 37"- 52"						Glass Finish for Lite 37"- 52"									
	Width	18"	24"	30"	36"	42"	48"		Width	18"	24"	30"	36"	42"	48"
<b>GR</b>	1/4"clear temp	\$158	\$211	\$264	\$317	\$368	\$421	<b>GC</b>	1/2" clear temp	\$416	\$556	\$695	\$834	\$973	\$1111
<b>GP</b>	1/4"pattern62	\$216	\$288	\$359	\$431	\$503	\$575	<b>GJ</b>	1/2" laminated	\$835	\$1116	\$1391	\$1669	\$1949	\$2226
<b>GS</b>	1/4"laminated	\$439	\$586	\$733	\$878	\$1026	\$1172	<b>GU</b>	1/2" frosted	\$966	\$1289	\$1610	\$1930	\$2254	\$2575
<b>GG</b>	1/4" frosted	\$551	\$739	\$918	\$1102	\$1285	\$1468	<b>GV</b>	1/2" white lam	\$1091	\$1457	\$1818	\$2180	\$2544	\$2906
<b>GL</b>	1/4"white lam	\$595	\$796	\$994	\$1192	\$1391	\$1589								
<b>GW</b>	3/8" clear temp	\$288	\$383	\$478	\$575	\$670	\$763								
<b>GY</b>	3/8" laminated	\$617	\$829	\$1026	\$1234	\$1436	\$1640								
<b>GZ</b>	3/8" frosted	\$758	\$1016	\$1264	\$1517	\$1768	\$2021								
<b>GI</b>	3/8" white lam	\$997	\$1332	\$1661	\$1993	\$2326	\$2658								
Glass Finish for Lite 53"- 66"						Glass Finish for Lite 53"- 66"									
	Width	18"	24"	30"	36"	42"	48"		Width	18"	24"	30"	36"	42"	48"
<b>GR</b>	1/4"clear temp	\$211	\$281	\$352	\$421	\$492	\$563	<b>GC</b>	1/2" clear temp	\$556	\$742	\$926	\$1111	\$1297	\$1482
<b>GP</b>	1/4"pattern62	\$288	\$383	\$479	\$575	\$671	\$767	<b>GJ</b>	1/2" laminated	\$1114	\$1488	\$1854	\$2225	\$2599	\$2969
<b>GS</b>	1/4"laminated	\$586	\$781	\$976	\$1171	\$1366	\$1562	<b>GU</b>	1/2" frosted	\$1289	\$1718	\$2147	\$2573	\$3005	\$3432
<b>GG</b>	1/4" frosted	\$734	\$985	\$1225	\$1470	\$1714	\$1956	<b>GV</b>	1/2" white lam	\$1456	\$1942	\$2423	\$2906	\$3392	\$3876
<b>GL</b>	1/4"white lam	\$794	\$1058	\$1324	\$1589	\$1854	\$2118								
<b>GW</b>	3/8" clear temp	\$383	\$511	\$637	\$767	\$893	\$1018								
<b>GY</b>	3/8" laminated	\$822	\$1105	\$1367	\$1644	\$1915	\$2186								
<b>GZ</b>	3/8" frosted	\$1012	\$1355	\$1685	\$2023	\$2358	\$2694								
<b>GI</b>	3/8" white lam	\$1328	\$1776	\$2215	\$2658	\$3100	\$3544								
Glass Finish for Lite 67"- 80"						Glass Finish for Lite 67"- 80"									
	Width	18"	24"	30"	36"	42"	48"		Width	18"	24"	30"	36"	42"	48"
<b>GR</b>	1/4"clear temp	\$264	\$352	\$438	\$527	\$614	\$703	<b>GC</b>	1/2" clear temp	\$695	\$926	\$1158	\$1390	\$1621	\$1853
<b>GP</b>	1/4"pattern62	\$359	\$479	\$599	\$719	\$839	\$959	<b>GJ</b>	1/2" laminated	\$1393	\$1861	\$2320	\$2783	\$3247	\$3710
<b>GS</b>	1/4"laminated	\$732	\$976	\$1220	\$1465	\$1708	\$1954	<b>GU</b>	1/2" frosted	\$1610	\$2148	\$2683	\$3215	\$3757	\$4291
<b>GG</b>	1/4" frosted	\$918	\$1231	\$1530	\$1837	\$2143	\$2447	<b>GV</b>	1/2" white lam	\$1818	\$2428	\$3030	\$3634	\$4241	\$4844
<b>GL</b>	1/4"white lam	\$994	\$1324	\$1655	\$1985	\$2317	\$2648								
<b>GW</b>	3/8" clear temp	\$479	\$638	\$796	\$959	\$1115	\$1273	<b>GX</b>	custom or CUS						
<b>GY</b>	3/8" laminated	\$1027	\$1381	\$1709	\$2056	\$2393	\$2735	<b>FX</b>	custom applied film						
<b>GZ</b>	3/8" frosted	\$1265	\$1693	\$2105	\$2528	\$2947	\$3367								
<b>GI</b>	3/8" white lam	\$1661	\$2220	\$2768	\$3322	\$3876	\$4429								

i | 2 | 2 | 8 | . | | | |

| | | |

- i2283 HARD / HARD SURFACE INSERT, 8-16"**
- i2284 HARD / TACK SURFACE INSERT, 8-16"**
- i2285 TACK / TACK SURFACE INSERT, 8-16"**
- i2287 SYSTEMS HARD / HARD SURFACE INSERT, 8-16"**
- i2288 SYSTEMS HARD / TACK SURFACE INSERT, 8-16"**
- i2289 SYSTEMS TACK / TACK SURFACE INSERT, 8-16"**

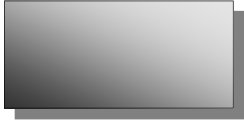

8 - 16"  
hard surface  
tack surface  
hard / tack surface

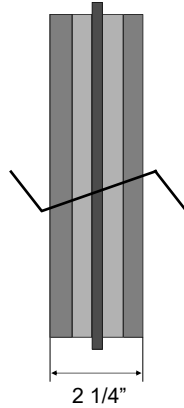

**PRODUCT INFORMATION**

**Features:**

- Use when ordering Modular Panel Frame ( i2275 or i2276 ) - comes pre-installed
- Use when ordering the following nonstandard panel details:
  1. Selection & location of any combination of glazing or solid lite filler
  2. Custom layout of lites & vertical location of horizontal muntins
- Durable composite substrate
- Receives specified finish on both sides

**Specifiers:**

- Requires use of *Modular Panel Frame Worksheet* (see appendix)
- Identify product number
- Identify insert height
- Use modular panel widths as required by layout using same panel width as Modular Panel Frame ( i2275 or i2276 )
- Identify finish for each face separately  
See appendix for vinyl styles and colors
- For "CUS" option - supply .5 linear yards of fabric per side, 1 linear yard total per insert
- "Adobe" vinyl not available on Tack Surface
- Order Modular Panel Frame ( i2275 or i2276 ) separately

Product Number		
<b>i2283.</b>	hard surface both sides	\$218
<b>i2287.</b>	for systems	\$218
<b>i2284.</b>	hard surface side 1, tack surface side 2	\$232
<b>i2288.</b>	for systems	\$232
<b>i2285.</b>	tack surface both sides	\$257
<b>i2289.</b>	for systems	\$257

Panel Width		
<b>18</b>	18"	+\$0
<b>24</b>	24"	+\$10
<b>30</b>	30"	+\$23
<b>36</b>	36"	+\$32
<b>42</b>	42"	+\$42
<b>48</b>	48"	+\$52
Systems Panel Width		
<b>23</b>	23"	+\$10
<b>29</b>	29"	+\$23
<b>35</b>	35"	+\$32
<b>41</b>	41"	+\$42
<b>47</b>	47"	+\$52

Surface Finish Side 1 / Side 2		
First 2 digits specify series, last 2 specify color		
<b>CUS</b>	customer material	+\$1
<b>AD__</b>	adobe	+\$13
----	category 1	+\$30
----	category 2	+\$34
----	category 3	+\$38
----	category 4	+\$49
----	category 5	+\$68
----	category 6	+\$101
----	category 7	+\$130

Insert Height	
<b>16</b>	16"
<b>CC</b>	8 - 15"

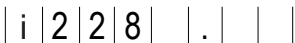



- i2283 HARD / HARD SURFACE INSERT, 17-32"**
- i2284 HARD / TACK SURFACE INSERT, 17-32"**
- i2285 TACK / TACK SURFACE INSERT, 17-32"**
- i2287 SYSTEMS HARD / HARD SURFACE INSERT, 17-32"**
- i2288 SYSTEMS HARD / TACK SURFACE INSERT, 17-32"**
- i2289 SYSTEMS TACK / TACK SURFACE INSERT, 17-32"**



17 - 32"  
hard surface  
tack surface  
hard / tack surface

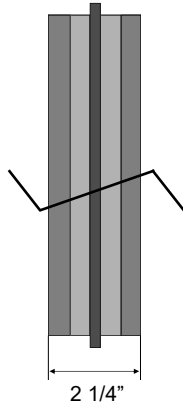

**PRODUCT INFORMATION**

**Features:**

- Use when ordering Modular Panel Frame (i2275 or i2276) - comes pre-installed
- Use when ordering the following nonstandard panel details:
  1. Selection & location of any combination of glazing or solid lite filler
  2. Custom layout of lites & vertical location of horizontal muntins
- Durable composite substrate
- Receives specified finish on both sides

**Specifiers:**

- Requires use of *Modular Panel Frame Worksheet* (see appendix)
- Identify product number
- Use modular panel widths as required by layout using same panel width as Modular Panel Frame (i2275 or i2276)
- Identify finish for each face separately  
See appendix for vinyl styles and colors
- For "CUS" option - supply 1 linear yards of fabric per side, 2 linear yards total per insert
- "Adobe" vinyl not available on Tack Surface
- Order Modular Panel Frame (i2275 or i2276) separately

Product Number		
i2283.	hard surface	\$252
	both sides	
i2287.	for systems	\$252
i2284.	hard surface	\$278
	side 1, tack	
	surface side 2	
i2288.	for systems	\$278
i2285.	tack surface	\$329
	both sides	
i2289.	for systems	\$329

Panel Width		
18	18"	+\$0
24	24"	+\$18
30	30"	+\$50
36	36"	+\$67
42	42"	+\$85
48	48"	+\$102
Systems Panel Width		
23	23"	+\$18
29	29"	+\$50
35	35"	+\$67
41	41"	+\$85
47	47"	+\$102

Surface Finish Side 1 / Side 2		
First 2 digits specify series, last 2 specify color		
CUS	customer material	+\$4
AD	adobe	+\$25
----	category 1	+\$61
----	category 2	+\$67
----	category 3	+\$77
----	category 4	+\$100
----	category 5	+\$137
----	category 6	+\$202
----	category 7	+\$259

Insert Height	
32	32"
CC	17 - 31"

i	2	2	8	.			
---	---	---	---	---	--	--	--

--	--	--

--	--	--	--	--	--	--	--

- i2283 HARD / HARD SURFACE INSERT, 33-48"**
- i2284 HARD / TACK SURFACE INSERT, 33-48"**
- i2285 TACK / TACK SURFACE INSERT, 33-48"**
- i2287 SYSTEMS HARD / HARD SURFACE INSERT, 33-48"**
- i2288 SYSTEMS HARD / TACK SURFACE INSERT, 33-48"**
- i2289 SYSTEMS TACK / TACK SURFACE INSERT, 33-48"**



33 - 48"  
hard surface  
tack surface  
hard / tack surface

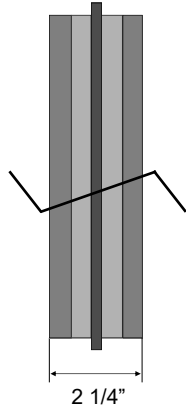

**PRODUCT INFORMATION**

**Features:**

- Use when ordering Modular Panel Frame ( i2275 or i2276 ) - comes pre-installed
- Use when ordering the following nonstandard panel details:
  1. Selection & location of any combination of glazing or solid lite filler
  2. Custom layout of lites & vertical location of horizontal muntins
- Durable composite substrate
- Receives specified finish on both sides

**Specifiers:**

- Requires use of *Modular Panel Frame Worksheet* (see appendix)
- Identify product number
- Identify insert height
- Use modular panel widths as required by layout using same panel width as Modular Panel Frame ( i2275 or i2276 )
- Identify finish for each face separately  
See appendix for vinyl styles and colors
- For "CUS" option - supply 1.5 linear yards of fabric per side, 3 linear yards total per insert
- "Adobe" vinyl not available on Tack Surface
- Order Modular Panel Frame ( i2275 or i2276 ) separately

Product Number		
<b>i2283.</b>	hard surface both sides	\$286
<b>i2287.</b>	for systems	\$286
<b>i2284.</b>	hard surface side 1, tack surface side 2	\$324
<b>i2288.</b>	for systems	\$324
<b>i2285.</b>	tack surface both sides	\$401
<b>i2289.</b>	for systems	\$401

Panel Width		
<b>18</b>	18"	+\$0
<b>24</b>	24"	+\$28
<b>30</b>	30"	+\$72
<b>36</b>	36"	+\$100
<b>42</b>	42"	+\$126
<b>48</b>	48"	+\$154

Systems Panel Width		
<b>23</b>	23"	+\$28
<b>29</b>	29"	+\$72
<b>35</b>	35"	+\$100
<b>41</b>	41"	+\$126
<b>47</b>	47"	+\$154

Surface Finish Side 1 / Side 2		
First 2 digits specify series, last 2 specify color		
<b>CUS</b>	customer material	+\$5
<b>AD __</b>	adobe	+\$38
<b>----</b>	category 1	+\$91
<b>----</b>	category 2	+\$101
<b>----</b>	category 3	+\$115
<b>----</b>	category 4	+\$149
<b>----</b>	category 5	+\$206
<b>----</b>	category 6	+\$302
<b>----</b>	category 7	+\$388

Insert Height	
<b>48</b>	48"
<b>CC</b>	33 - 47"

i	2	2	8	.					
---	---	---	---	---	--	--	--	--	--

--	--	--	--

--	--	--	--	--	--	--	--	--	--

- i2283 HARD / HARD SURFACE INSERT, 49-64"**
- i2284 HARD / TACK SURFACE INSERT, 49-64"**
- i2285 TACK / TACK SURFACE INSERT, 49-64"**
- i2287 SYSTEMS HARD / HARD SURFACE INSERT, 49-64"**
- i2288 SYSTEMS HARD / TACK SURFACE INSERT, 49-64"**
- i2289 SYSTEMS TACK / TACK SURFACE INSERT, 49-64"**



49 - 64"  
hard surface  
tack surface  
hard / tack surface

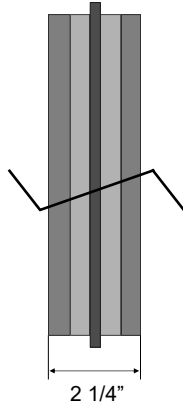

**PRODUCT INFORMATION**

**Features:**

- Use when ordering Modular Panel Frame (i2275 or i2276) - comes pre-installed
- Use when ordering the following nonstandard panel details:
  1. Selection & location of any combination of glazing or solid lite filler
  2. Custom layout of lites & vertical location of horizontal muntins
- Durable composite substrate
- Receives specified finish on both sides

**Specifiers:**

- Requires use of *Modular Panel Frame Worksheet* (see appendix)
- Identify product number
- Identify insert height
- Use modular panel widths as required by layout using same panel width as Modular Panel Frame (i2275 or i2276)
- Identify finish for each face separately  
See appendix for vinyl styles and colors
- For "CUS" option - supply 2 linear yards of fabric per side, 4 linear yards total per insert
- "Adobe" vinyl not available on Tack Surface
- Order Modular Panel Frame (i2275 or i2276) separately

Product Number		
i2283.	hard surface both sides	\$371
i2287.	for systems	\$371
i2284.	hard surface side 1, tack surface side 2	\$421
i2288.	for systems	\$421
i2285.	tack surface both sides	\$524
i2289.	for systems	\$524

Panel Width		
18	18"	+\$0
24	24"	+\$36
30	30"	+\$92
36	36"	+\$118
42	42"	+\$166
48	48"	+\$203
Systems Panel Width		
23	23"	+\$36
29	29"	+\$92
35	35"	+\$118
41	41"	+\$166
47	47"	+\$203

Surface Finish Side 1 / Side 2		
First 2 digits specify series, last 2 specify color		
CUS	customer material	+\$6
AD __	adobe	+\$52
----	category 1	+\$121
----	category 2	+\$134
----	category 3	+\$154
----	category 4	+\$198
----	category 5	+\$275
----	category 6	+\$402
----	category 7	+\$517

Insert Height	
64	64"
CC	49 - 63"

i | 2 | 2 | 8 | . | | | |

| | |

| | | | | | | |

- i2283 HARD / HARD SURFACE INSERT, 65-80"
- i2284 HARD / TACK SURFACE INSERT, 65-80"
- i2285 TACK / TACK SURFACE INSERT, 65-80"
- i2287 SYSTEMS HARD / HARD SURFACE INSERT, 65-80"
- i2288 SYSTEMS HARD / TACK SURFACE INSERT, 65-80"
- i2289 SYSTEMS TACK / TACK SURFACE INSERT, 65-80"



65 - 80"  
hard surface  
tack surface  
hard / tack surface

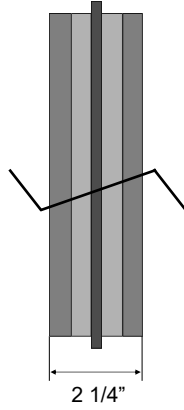

**PRODUCT INFORMATION**

**Features:**

- Use when ordering Modular Panel Frame (i2275 or i2276) - comes pre-installed
- Use when ordering the following nonstandard panel details:
  1. Selection & location of any combination of glazing or solid lite filler
  2. Custom layout of lites & vertical location of horizontal muntins
- Durable composite substrate
- Receives specified finish on both sides

**Specifiers:**

- Requires use of *Modular Panel Frame Worksheet* (see appendix)
- Identify product number
- Identify insert height
- Use modular panel widths as required by layout using same panel width as Modular Panel Frame (i2275 or i2276)
- Identify finish for each face separately  
See appendix for vinyl styles and colors
- For "CUS" option - supply 2.5 linear yards of fabric per side, 5 linear yards total per insert
- "Adobe" vinyl not available on Tack Surface
- Order Modular Panel Frame (i2275 or i2276) separately

Product Number		
i2283.	hard surface both sides	\$404
i2287.	for systems	\$404
i2284.	hard surface side 1, tack surface side 2	\$468
i2288.	for systems	\$468
i2285.	tack surface both sides	\$595
i2289.	for systems	\$595

Panel Width		
18	18"	+\$0
24	24"	+\$46
30	30"	+\$115
36	36"	+\$161
42	42"	+\$208
48	48"	+\$253
Systems Panel Width		
23	23"	+\$46
29	29"	+\$115
35	35"	+\$161
41	41"	+\$208
47	47"	+\$253

Surface Finish Side 1 / Side 2		
First 2 digits specify series, last 2 specify color		
CUS	customer material	+\$8
AD __	adobe	+\$64
----	category 1	+\$151
----	category 2	+\$168
----	category 3	+\$192
----	category 4	+\$247
----	category 5	+\$343
----	category 6	+\$503
----	category 7	+\$648

Insert Height	
80	80"
CC	65 - 79"

i | 2 | 2 | 8 | . | | |

| | |

| | | | | | | |

- i2283 HARD / HARD SURFACE INSERT, 81-96"
- i2284 HARD / TACK SURFACE INSERT, 81-96"
- i2285 TACK / TACK SURFACE INSERT, 81-96"
- i2287 SYSTEMS HARD / HARD SURFACE INSERT, 81-96"
- i2288 SYSTEMS HARD / TACK SURFACE INSERT, 81-96"
- i2289 SYSTEMS TACK / TACK SURFACE INSERT, 81-96"



81 - 96"  
hard surface  
tack surface  
hard / tack surface

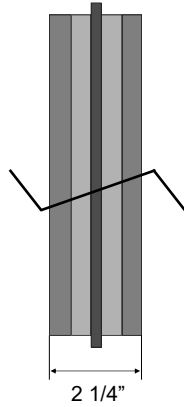

## PRODUCT INFORMATION

### Features:

- Use when ordering Modular Panel Frame (i2275 or V2276) - comes pre-installed
- Use when ordering the following nonstandard panel details:
  1. Selection & location of any combination of glazing or solid lite filler
  2. Custom layout of lites & vertical location of horizontal muntins
- Durable composite substrate
- Receives specified finish on both sides

### Specifiers:

- Requires use of *Modular Panel Frame Worksheet* (see appendix)
- Identify product number
- Identify insert height
- Use modular panel widths as required by layout using same panel width as Modular Panel Frame (i2275 or i2276)
- Identify finish for each face separately  
See appendix for vinyl styles and colors
- For "CUS" option - supply 3 linear yards of fabric per side, 6 linear yards total per insert
- "Adobe" vinyl not available on Tack Surface
- Order Modular Panel Frame (i2275 or i2276) separately

Product Number		
i 2283.	hard surface	\$488
	both sides	
i 2287.	for systems	\$488
i 2284.	hard surface	\$565
	side 1, tack	
	surface side 2	
i 2288.	for systems	\$565
i 2285.	tack surface	\$719
	both sides	
i 2289.	for systems	\$719

Panel Width		
18	18"	+\$0
24	24"	+\$55
30	30"	+\$143
36	36"	+\$185
42	42"	+\$251
48	48"	+\$306
Systems Panel Width		
23	23"	+\$55
29	29"	+\$143
35	35"	+\$185
41	41"	+\$251
47	47"	+\$306

Surface Finish	Side 1 / Side 2	
First 2 digits specify series, last 2 specify color		
CUS	customer material	+\$10
AD	adobe	+\$77
----	category 1	+\$182
----	category 2	+\$202
----	category 3	+\$230
----	category 4	+\$298
----	category 5	+\$412
----	category 6	+\$604
----	category 7	+\$778

Insert Height	
CC	81 - 95"
96	96"
99	97" -114"

i 2 2 8 .

- i2291 HARD / HARD SURFACE OUTSERT, 8-16"**
- i2292 HARD / TACK SURFACE OUTSERT, 8-16"**
- i2293 TACK / TACK SURFACE OUTSERT, 8-16"**
- i2296 SYSTEMS HARD / HARD SURFACE OUTSERT, 8-16"**
- i2297 SYSTEMS HARD / TACK SURFACE OUTSERT, 8-16"**
- i2298 SYSTEMS TACK / TACK SURFACE OUTSERT, 8-16"**



8 - 16"  
hard surface  
tack surface  
hard / tack surface

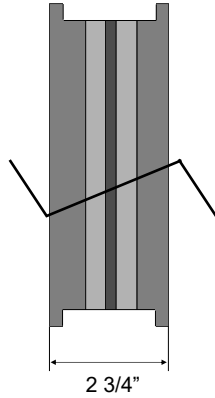

**PRODUCT INFORMATION**

**Features:**

- Use when ordering Modular Panel Frame (i2275 or i2276) - comes pre-installed
- Use when ordering the following nonstandard panel details:
  1. Selection & location of any combination of glazing or solid lite filler
  2. Custom layout of lites & vertical location of horizontal muntins
- Durable composite substrate
- Receives specified finish on both sides

**Specifiers:**

- Requires use of *Modular Panel Frame Worksheet* (see appendix)
- Identify product number
- Identify outsert height
- Use modular panel widths as required by layout using same panel width as Modular Panel Frame (i2275 or i2276)
- Identify finish for each face separately  
See appendix for vinyl styles and colors
- For "CUS" option - supply .5 linear yard of fabric per side, 1 linear yard total per outsert
- "Adobe" vinyl not available on Tack Surface
- Order Modular Panel Frame (i2275 or i2276) separately

Product Number		
<b>i2291.</b>	hard surface both sides	\$307
<b>i2296.</b>	for systems	\$307
<b>i2292.</b>	hard surface side 1, tack surface side 2	\$319
<b>i2297.</b>	for systems	\$319
<b>i2293.</b>	tack surface both sides	\$344
<b>i2298.</b>	for systems	\$344

Panel Width		
<b>18</b>	18"	+\$0
<b>24</b>	24"	+\$10
<b>30</b>	30"	+\$22
<b>36</b>	36"	+\$29
<b>42</b>	42"	+\$41
<b>48</b>	48"	+\$50
Systems Panel Width		
<b>23</b>	23"	+\$10
<b>29</b>	29"	+\$22
<b>35</b>	35"	+\$29
<b>41</b>	41"	+\$41
<b>47</b>	47"	+\$50

Surface Finish Side 1 / Side 2		
First 2 digits specify series, last 2 specify color		
<b>CUS</b>	customer material	+\$2
<b>AD</b> __	adobe	+\$13
----	category 1	+\$30
----	category 2	+\$34
----	category 3	+\$38
----	category 4	+\$49
----	category 5	+\$68
----	category 6	+\$101
----	category 7	+\$130

Outsert Height	
<b>16</b>	16"
<b>CC</b>	8 - 15"

i | 2 | 2 | 9 | . | | | |

| | |

| | | | | | | | | |

- i2291 HARD / HARD SURFACE OUTSERT, 17-32"**
- i2292 HARD / TACK SURFACE OUTSERT, 17-32"**
- i2293 TACK / TACK SURFACE OUTSERT, 17-32"**
- i2296 SYSTEMS HARD / HARD SURFACE OUTSERT, 17-32"**
- i2297 SYSTEMS HARD / TACK SURFACE OUTSERT, 17-32"**
- i2298 SYSTEMS TACK / TACK SURFACE OUTSERT, 17-32"**

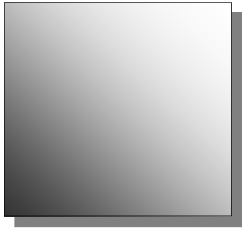

17 - 32"  
hard surface  
tack surface  
hard / tack surface

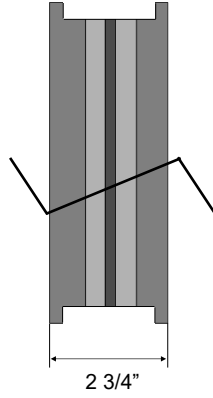

**PRODUCT INFORMATION**

**Features:**

- Use when ordering Modular Panel Frame (i2275 or i2276) - comes pre-installed
- Use when ordering the following nonstandard panel details:
  1. Selection & location of any combination of glazing or solid lite filler
  2. Custom layout of lites & vertical location of horizontal muntins
- Durable composite substrate
- Receives specified finish on both sides

**Specifiers:**

- Requires use of *Modular Panel Frame Worksheet* (see appendix)
- Identify product number
- Identify outsert height
- Use modular panel widths as required by layout using same panel width as Modular Panel Frame (i2275 or i2276)
- Identify finish for each face separately  
See appendix for vinyl styles and colors
- For "CUS" option - supply 1 linear yard of fabric per side, 2 linear yards total per outsert
- "Adobe" vinyl not available on Tack Surface
- Order Modular Panel Frame (i2275 or i2276) separately

Product Number		
i 2291.	hard surface both sides	\$358
i 2296.	for systems	\$358
i 2292.	hard surface side 1, tack surface side 2	\$383
i 2297.	for systems	\$383
i 2293.	tack surface both sides	\$434
i 2298.	for systems	\$434

Panel Width		
18	18"	+\$0
24	24"	+\$18
30	30"	+\$49
36	36"	+\$67
42	42"	+\$85
48	48"	+\$102
Systems Panel Width		
23	23"	+\$18
29	29"	+\$49
35	35"	+\$67
41	41"	+\$85
47	47"	+\$102

Surface Finish Side 1 / Side 2		
First 2 digits specify series, last 2 specify color		
CUS	customer material	+\$4
AD __	adobe	+\$25
----	category 1	+\$61
----	category 2	+\$67
----	category 3	+\$77
----	category 4	+\$100
----	category 5	+\$137
----	category 6	+\$202
----	category 7	+\$235

Outsert Height	
32	32"
CC	17 - 31"

i | 2 | 2 | 9 | . | | | |

| | |

| | | | | | | | | |

- i2291 HARD / HARD SURFACE OUTSERT, 33-48"**
- i2292 HARD / TACK SURFACE OUTSERT, 33-48"**
- i2293 TACK / TACK SURFACE OUTSERT, 33-48"**
- i2296 SYSTEMS HARD / HARD SURFACE OUTSERT, 33-48"**
- i2297 SYSTEMS HARD / TACK SURFACE OUTSERT, 33-48"**
- i2298 SYSTEMS TACK / TACK SURFACE OUTSERT, 33-48"**



33 - 48"  
hard surface  
tack surface  
hard / tack surface

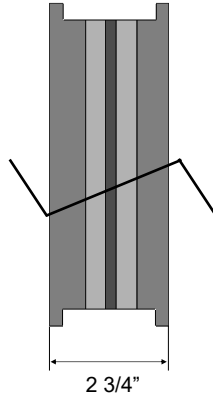

**PRODUCT INFORMATION**

**Features:**

- Use when ordering Modular Panel Frame ( i2275 or i2276 ) - comes pre-installed
- Use when ordering the following nonstandard panel details:
  1. Selection & location of any combination of glazing or solid lite filler
  2. Custom layout of lites & vertical location of horizontal muntins
- Durable composite substrate
- Receives specified finish on both sides

**Specifiers:**

- Requires use of *Modular Panel Frame Worksheet* (see appendix)
- Identify product number
- Identify outsert height
- Use modular panel widths as required by layout using same panel width as Modular Panel Frame ( i2275 or i2276 )
- Identify finish for each face separately  
See appendix for vinyl styles and colors
- For "CUS" option - supply 1.5 linear yards of fabric per side, 3 linear yards total per outsert
- "Adobe" vinyl not available on Tack Surface
- Order Modular Panel Frame ( i2275 or i2276 ) separately

Product Number		
<b>i2291.</b>	hard surface both sides	\$409
<b>i2296.</b>	for systems	\$409
<b>i2292.</b>	hard surface side 1, tack surface side 2	\$448
<b>i2297.</b>	for systems	\$448
<b>i2293.</b>	tack surface both sides	\$524
<b>i2298.</b>	for systems	\$524

Panel Width		
<b>18</b>	18"	+\$0
<b>24</b>	24"	+\$26
<b>30</b>	30"	+\$72
<b>36</b>	36"	+\$98
<b>42</b>	42"	+\$126
<b>48</b>	48"	+\$154
Systems Panel Width		
<b>23</b>	23"	+\$26
<b>29</b>	29"	+\$72
<b>35</b>	35"	+\$98
<b>41</b>	41"	+\$126
<b>47</b>	47"	+\$154

Surface Finish Side 1 / Side 2		
First 2 digits specify series, last 2 specify color		
<b>CUS</b>	customer material	+\$5
<b>AD</b>	adobe	+\$38
----	category 1	+\$91
----	category 2	+\$101
----	category 3	+\$115
----	category 4	+\$149
----	category 5	+\$206
----	category 6	+\$302
----	category 7	+\$353

Outsert Height	
<b>48</b>	48"
<b>CC</b>	33 - 47"

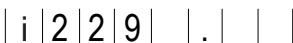



- i2291 HARD / HARD SURFACE OUTSERT, 49-64"
- i2292 HARD / TACK SURFACE OUTSERT, 49-64"
- i2293 TACK / TACK SURFACE OUTSERT, 49-64"
- i2296 SYSTEMS HARD / HARD SURFACE OUTSERT, 49-64"
- i2297 SYSTEMS HARD / TACK SURFACE OUTSERT, 49-64"
- i2298 SYSTEMS TACK / TACK SURFACE OUTSERT, 49-64"



33 - 48"  
hard surface  
tack surface  
hard / tack surface

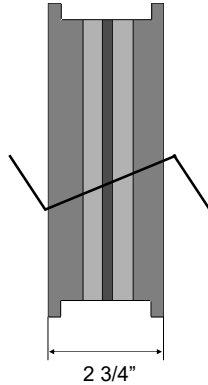

**PRODUCT INFORMATION**

**Features:**

- Use when ordering Modular Panel Frame (i2275 or i2276) - comes pre-installed
- Use when ordering the following nonstandard panel details:
  1. Selection & location of any combination of glazing or solid lite filler
  2. Custom layout of lites & vertical location of horizontal muntins
- Durable composite substrate
- Receives specified finish on both sides

**Specifiers:**

- Requires use of *Modular Panel Frame Worksheet* (see appendix)
- Identify product number
- Identify outsert height
- Use modular panel widths as required by layout using same panel width as Modular Panel Frame (i2275 or i2276)
- Identify finish for each face separately  
See appendix for vinyl styles and colors
- For "CUS" option - supply 2 linear yards of fabric per side, 4 linear yards total per outsert
- "Adobe" vinyl not available on Tack Surface
- Order Modular Panel Frame (i2275 or i2276) separately

Product Number		
i 2291.	hard surface both sides	\$511
i 2296.	for systems	\$511
i 2292.	hard surface side 1, tack surface side 2	\$563
i 2297.	for systems	\$563
i 2293.	tack surface both sides	\$665
i 2298.	for systems	\$665

Outsert Height	
64	64"
CC	49 - 63"

Panel Width		
18	18"	+\$0
24	24"	+\$37
30	30"	+\$92
36	36"	+\$130
42	42"	+\$166
48	48"	+\$203
Systems Panel Width		
23	23"	+\$37
29	29"	+\$92
35	35"	+\$130
41	41"	+\$166
47	47"	+\$203

Surface Finish Side 1 / Side 2		
First 2 digits specify series, last 2 specify color		
CUS	customer material	+\$6
AD	adobe	+\$52
----	category 1	+\$121
----	category 2	+\$134
----	category 3	+\$154
----	category 4	+\$198
----	category 5	+\$275
----	category 6	+\$402
----	category 7	+\$517

i 2 2 9 .

- i2291 HARD / HARD SURFACE OUTSERT, 65-80"
- i2292 HARD / TACK SURFACE OUTSERT, 65-80"
- i2293 TACK / TACK SURFACE OUTSERT, 65-80"
- i2296 SYSTEMS HARD / HARD SURFACE OUTSERT, 65-80"
- i2297 SYSTEMS HARD / TACK SURFACE OUTSERT, 65-80"
- i2298 SYSTEMS TACK / TACK SURFACE OUTSERT, 65-80"

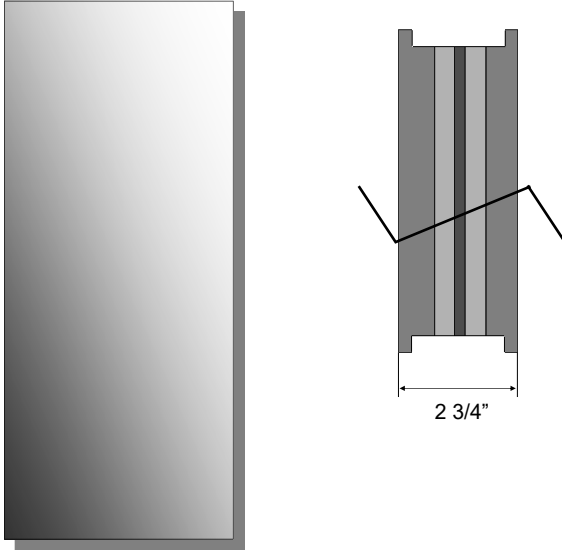

65 - 80"  
hard surface  
tack surface  
hard / tack surface

### PRODUCT INFORMATION

#### Features:

- Use when ordering Modular Panel Frame (i2275 or i2276) - comes pre-installed
- Use when ordering the following nonstandard panel details:
  1. Selection & location of any combination of glazing or solid lite filler
  2. Custom layout of lites & vertical location of horizontal muntins
- Durable composite substrate
- Receives specified finish on both sides

#### Specifiers:

- Requires use of *Modular Panel Frame Worksheet* (see appendix)
- Identify product number
- Identify outsert height
- Use modular panel widths as required by layout using same panel width as Modular Panel Frame (i2275 or i2276)
- Identify finish for each face separately  
See appendix for vinyl styles and colors
- For "CUS" option - supply 2.5 linear yards of fabric per side, 5 linear yards total per filler
- "Adobe" vinyl not available on Tack Surface
- Order Modular Panel Frame (i2275 or i2276) separately

Product Number		
i 2291.	hard surface both sides	\$563
i 2296.	for systems	\$563
i 2292.	hard surface side 1, tack surface side 2	\$626
i 2297.	for systems	\$626
i 2293.	tack surface both sides	\$754
i 2298.	for systems	\$754

Panel Width		
18	18"	+\$0
24	24"	+\$46
30	30"	+\$114
36	36"	+\$161
42	42"	+\$208
48	48"	+\$253
Systems Panel Width		
23	23"	+\$46
29	29"	+\$114
35	35"	+\$161
41	41"	+\$208
47	47"	+\$253

Surface Finish Side 1 / Side 2		
First 2 digits specify series, last 2 specify color		
CUS	customer material	+\$8
AD __	adobe	+\$64
----	category 1	+\$151
----	category 2	+\$168
----	category 3	+\$192
----	category 4	+\$247
----	category 5	+\$343
----	category 6	+\$503
----	category 7	+\$648

Outsert Height	
80	80"
CC	65 - 79"

i | 2 | 2 | 9 | . | | |

| | |

| | | | | | | | | |

- i2291 HARD / HARD SURFACE OUTSERT, 81-96"**
- i2292 HARD / TACK SURFACE OUTSERT, 81-96"**
- i2293 TACK / TACK SURFACE OUTSERT, 81-96"**
- i2296 SYSTEMS HARD / HARD SURFACE OUTSERT, 81-96"**
- i2297 SYSTEMS HARD / TACK SURFACE OUTSERT, 81-96"**
- i2298 SYSTEMS TACK / TACK SURFACE OUTSERT, 81-96"**

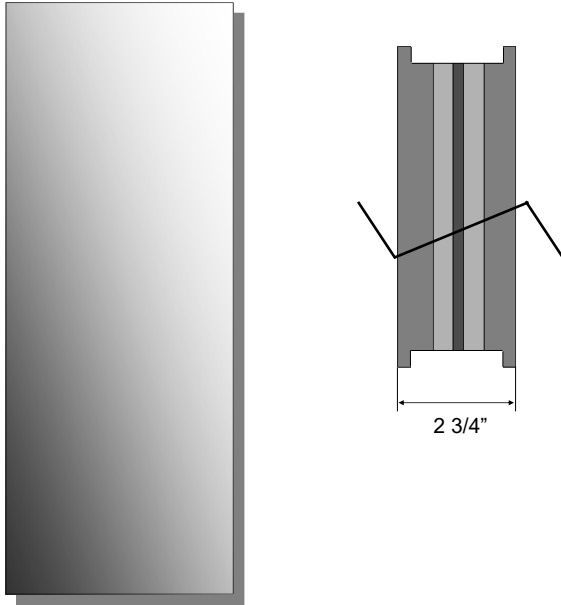

81 - 96"  
hard surface  
tack surface  
hard / tack surface

**PRODUCT INFORMATION**

**Features:**

- Use when ordering Modular Panel Frame ( i2275 or i2276 ) - comes pre-installed
- Use when ordering the following nonstandard panel details:
  1. Selection & location of any combination of glazing or solid lite filler
  2. Custom layout of lites & vertical location of horizontal muntins
- Durable composite substrate
- Receives specified finish on both sides

**Specifiers:**

- Requires use of *Modular Panel Frame Worksheet* (see appendix)
- Identify product number
- Identify outsert height
- Use modular panel widths as required by layout using same panel width as Modular Panel Frame ( i2275 or i2276 )
- Identify finish for each face separately  
See appendix for vinyl styles and colors
- For "CUS" option - supply 3 linear yards of fabric per side, 6 linear yard total per outsert
- "Adobe" vinyl not available on Tack Surface
- Order Modular Panel Frame ( i2275 or i2276 ) separately

Product Number		
<b>i 2291.</b>	hard surface both sides	\$665
<b>i 2296.</b>	for systems	\$665
<b>i 2292.</b>	hard surface side 1, tack surface side 2	\$742
<b>i 2297.</b>	for systems	\$742
<b>i 2293.</b>	tack surface both sides	\$894
<b>i 2298.</b>	for systems	\$894

Panel Width		
<b>18</b>	18"	+\$0
<b>24</b>	24"	+\$54
<b>30</b>	30"	+\$142
<b>36</b>	36"	+\$196
<b>42</b>	42"	+\$251
<b>48</b>	48"	+\$305
Systems Panel Width		
<b>23</b>	23"	+\$54
<b>29</b>	29"	+\$142
<b>35</b>	35"	+\$196
<b>41</b>	41"	+\$251
<b>47</b>	47"	+\$305

Surface Finish Side 1 / Side 2		
First 2 digits specify series, last 2 specify color		
<b>CUS</b>	customer material	+\$10
<b>AD</b>	adobe	+\$77
----	category 1	+\$182
----	category 2	+\$202
----	category 3	+\$230
----	category 4	+\$298
----	category 5	+\$412
----	category 6	+\$604
----	category 7	+\$778

Outsert Height	
<b>CC</b>	81 - 95"
<b>96</b>	96"
<b>99</b>	97 - 114"

i | 2 | 2 | 9 | . | | |

| | |

| | | | | | | |

# ELECTRICAL COMPONENTS

# i2230 ELECTRICAL COVERPLATES

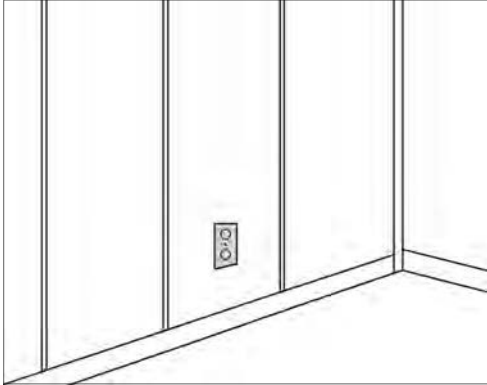

## PRODUCT INFORMATION

### Features:

- Cover the optional electrical systems offered with the panels
- Electrical switches and outlets are not included and must be installed by a locally approved licensed electrician

### Specifiers:

- Identify product number
- Identify finish color

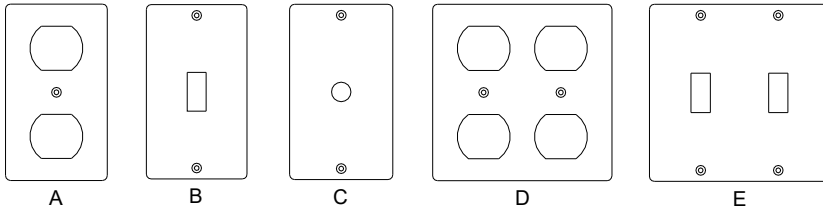

Product #			Finish	
1	duplex receptacle	\$16	<b>WH</b>	white
2	single switch	\$16	<b>IV</b>	ivory
3	telecommunication	\$16	<b>BW</b>	brown
4	double duplex	\$18	<b>CY</b>	grey
5	double switch	\$18	<b>SS</b>	stainless

i 2 2 3 0 . |

| |

**i2231 CEILING POWER JUMPER**

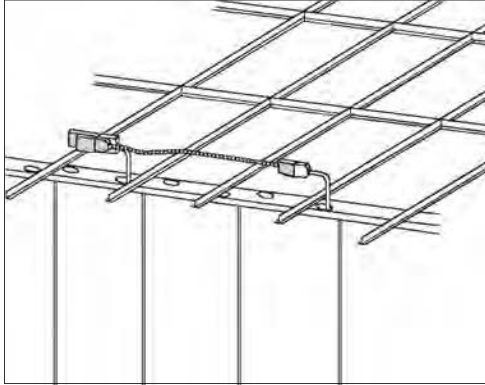

**PRODUCT INFORMATION**

**Features:**

- Allows two to ten E1 electrical drops to be interconnected to a single power feed

**Note:** Make note on order if using with panels built before 1995

**Specifiers:**

- Identify length

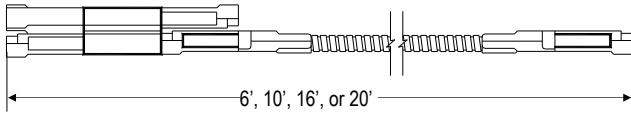

Length		
1	6'	\$182
2	10'	\$214
3	16'	\$250
4	20'	\$283

i 2 2 3 1 .

**i2234 POWER SPACER**

**i2236 MODULAR POWER SPACER**

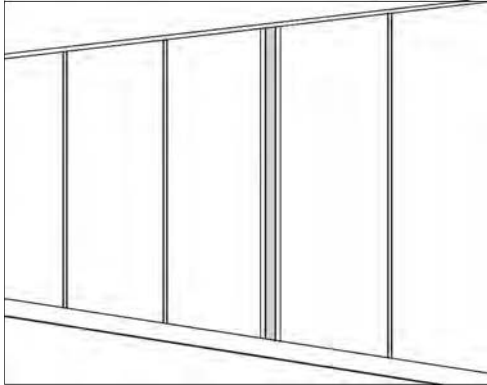

**PRODUCT INFORMATION**

**Features:**

- Connects two 180° wall runs
- Allows for vertical cabling or power
- Condition clips into ceiling runner, which is ordered separately

**Note:** Cannot be converted to a 2-way 90° Connector

**Specifiers:**

- Identify product number and ceiling height
- Identify surface finish for side 1 and side 2  
See appendix for vinyl styles and colors  
Specify "0000" for unfinished units; units must be field-finished
- For "CUS" option - supply 3.3 linear yards (min) per 4 units

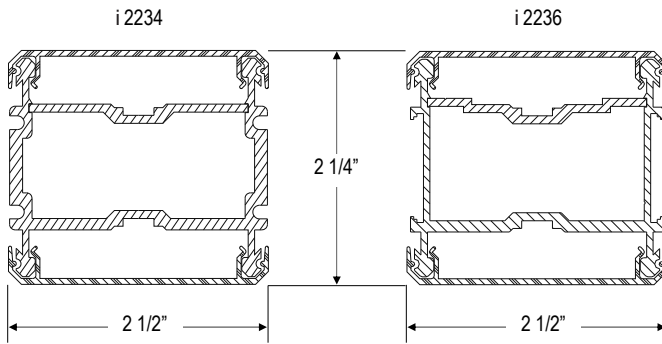

Product Number & Ceiling Height		
Power Spacer		
i2234.108	9'	\$364
i2234.120	10'	\$388
Modular Power Spacer		
i2236.108	9'	\$481
i2236.120	10'	\$502

Surface Finish Side 1 / Side 2		
First 2 digits specify series, last 2 specify color		
0000	unfinished	+\$0
CUS	customer material	+\$8
AD__	adobe	+\$14
----	price category 1	+\$35
----	price category 2	+\$38
----	price category 3	+\$44
----	price category 4	+\$58
----	price category 5	+\$80
----	price category 6	+\$116
----	price category 7	+\$149

i 2 2 3 . | | | |

| | | | | | | |

**i2237 MODULAR POWER SPACER, 3 WAY 90°**

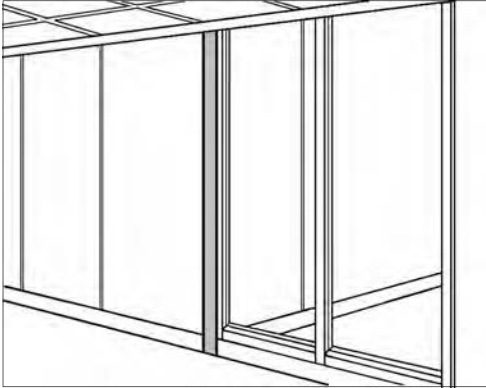

**PRODUCT INFORMATION**

**Features:**

- Connects three wall runs intersecting at 90°
- Allows for vertical cabling or power
- Connects to other Modular Components and Concealed Connector, Panel to Corner (i2351)

**Specifiers:**

- Identify ceiling height
- Identify surface finish  
See appendix for vinyl styles and colors  
Specify "0000" for unfinished units; units must be field-finished
- For "CUS" option - supply 3.3 linear yards (min) per 4 units

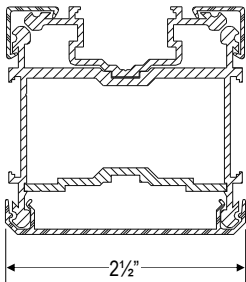

Ceiling Height		
108	9'	\$502
120	10'	\$530

Surface Finish		
First 2 digits specify series, last 2 specify color		
0000	unfinished	+\$0
CUS	customer material	+\$8
AD__	adobe	+\$14
----	price category 1	+\$35
----	price category 2	+\$38
----	price category 3	+\$44
----	price category 4	+\$58
----	price category 5	+\$80
----	price category 6	+\$116
----	price category 7	+\$149

i 2 2 3 7 . | | |

| | | |



# i2238 BY-PASS MODULAR SPACER

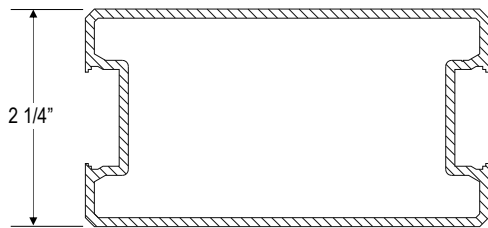

## PRODUCT INFORMATION

### Features:

- Single-extruded, 4 1/4" wide modular spacer connects two 180° wall runs for special fill applications
- Includes clips for attachment to modular components

### Specifiers:

- Identify ceiling height
- Identify finish color

### Ceiling Height

108	9'	\$439
120	10'	\$482

### Trim Finish

B3B2B0	alum
9FA1A0	anodized
EDE9E0	base white
C0B7A8	desert storm
89989D	epoxy blue
4F4546	espresso
918D81	glimmer bronze
48494D	graphite
F3FDFF	ice white
323836	matte slate
B8AEA3	metallic stone
40403F	midnight black
201920	onyx
605746	rust bronze
636D6F	space grey
EAEBE6	stone white
A49E9E	warm grey

i 2 2 3 8 .

# i2250 BASE POWER ENTRY

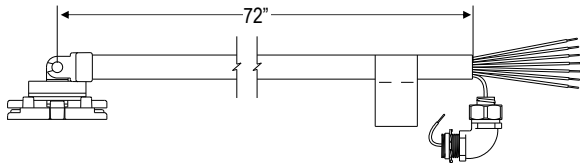
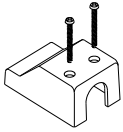
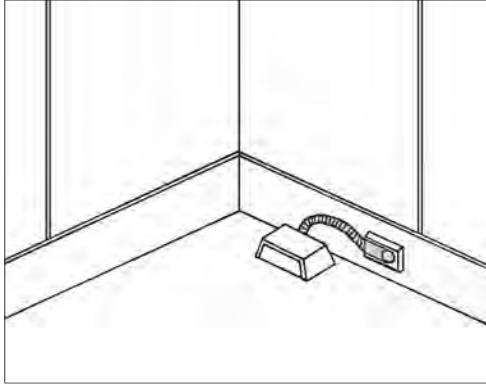

## PRODUCT INFORMATION

### Features:

- Connects a building's electrical supply from a wall, floor or column to the base electrical system
- Distributes up to four 20-amp circuits and includes a 6' cable which can be field cut to appropriate length
- Plugs directly into a Base Power Block (i2258) using the same connection point as receptacles
- UL listed and CSA certified
- Locally approved licensed electrician must wire power entry
- Not handed
- Base electrical requires use of 4" wireway (i2130) with gypsum panels
- Base electrical requires use of 6" Vinyl Base (i2140)

### Product Number

i2250      \$271

i 2 2 5 0 . |

**i2251 CEILING POWER ENTRY**

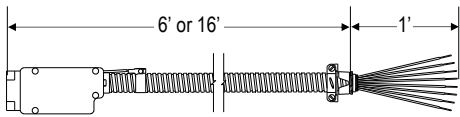
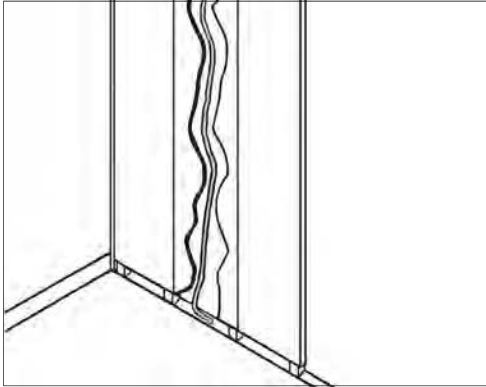

**PRODUCT INFORMATION**

**Features:**

- Connects a building's electrical supply from ceiling access to the base electrical system
- Can be run through a panel, 3-way, 4-way or 90° corner
- Distributes up to four 20-amp circuits
- Connects directly to a Base Power Block (i2258)
- UL listed and CSA certified
- Licensed electrician must wire power entry
- Special oval conduit comes with utility box connector and comes in two lengths: 6' long with 7' wires  
16' long with 17' wires
- Base electrical requires use of 4" wireway (i2130) with gypsum panels
- Base electrical requires use of 6" Vinyl Base (i2140)

**Specifiers:**

- Identify length

Length		
<b>06</b>	6'	\$264
<b>16</b>	16'	\$305

i 2 2 5 1 .

# i2252 BASELINE OPEN BOX

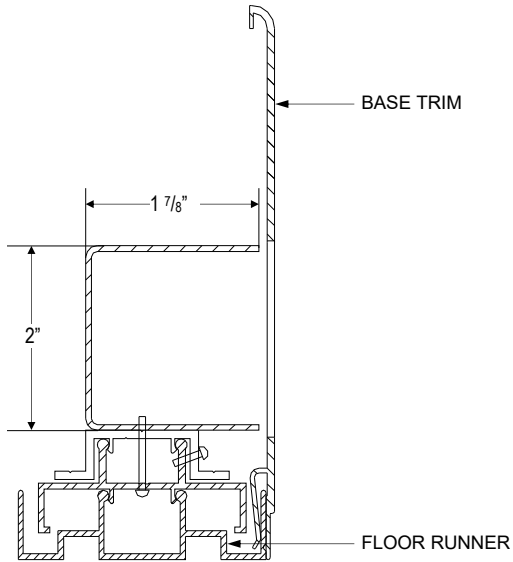

## PRODUCT INFORMATION

### Features:

- Open box for communications or field-installed wiring.
- Fits behind base trim
- Includes attachment clip and screws
- Attaches to Floor Runner (i2120) or Narrow Floor Runner (i2122) which are ordered separately
- Base electrical requires use of 4" wireway (i2130) with gypsum panels
- Base electrical requires use of 6" Vinyl Base (i2140)
- Handy Box is 2" x 4" x 1 7/8", equivalent to Raco® 660

Product Number	
i2252	\$40

i 2 2 5 2 . | | |

# i2254 POWER JUMPER

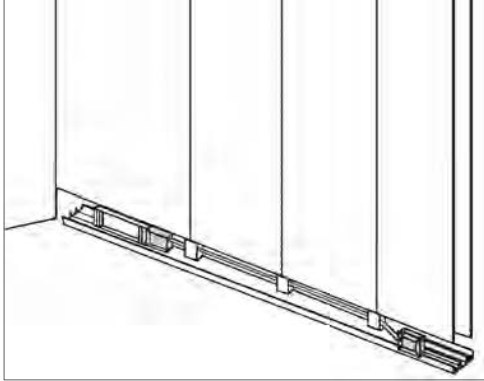

## PRODUCT INFORMATION

### Features:

- Distributes up to four 20-amp circuits and connects directly to a Base Power Block (i2258) or a Jumper Coupling (i2255)
- Encased in flexible oval conduit
- UL listed and CSA certified
- Lengths are net usable. For outlet blocks, figure center to center of panels and deduct 6", figure 12" for double blocks
- Can compress or expand 2"
- Base electrical requires use of 4" wireway (i2130) with gypsum panels
- Base electrical requires use of 6" Vinyl Base (i2140)

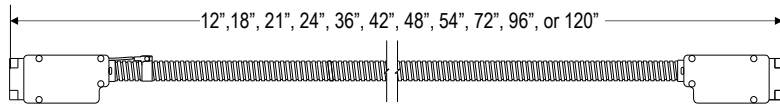

Length		
12	12"	\$137
18	18"	\$139
21	21"	\$142
24	24"	\$146
36	36"	\$160
42	42"	\$170
48	48"	\$182
54	54"	\$192
72	72"	\$226
96	96"	\$257
120	120"	\$290

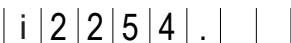

# i2255 JUMPER COUPLING

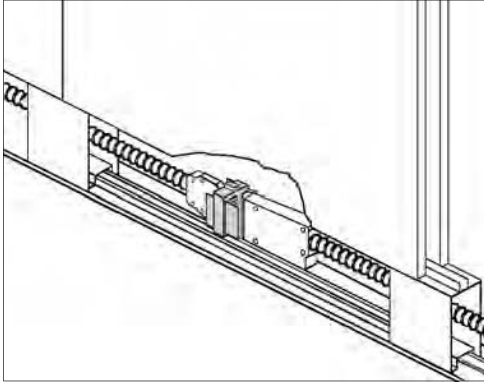

## PRODUCT INFORMATION

### Features:

- Connects Power Jumpers (i2254)
- Has connection points for four Power Jumpers (i2254) OR one Ceiling Power Entry (i2251) and three Power Jumpers (i2254)
- Allows extra long extensions or utilization of two shorter components for one longer connection
- Distributes up to four 20-amp circuits
- UL listed and CSA certified
- Base electrical requires use of 4" wireway (i2130) with gypsum panels
- Base electrical requires use of 6" Vinyl Base (i2140)

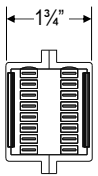

END

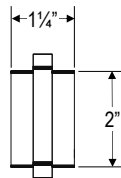

FRONT

Product Number	
i2255	\$54

i 2 2 5 5 .

**i2256 SYSTEMS POWER ADAPTER, CONCEALED**

**i2257 SYSTEMS POWER ADAPTER, EXPOSED**

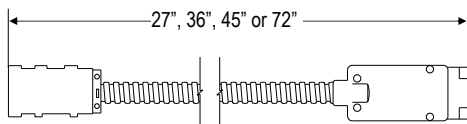
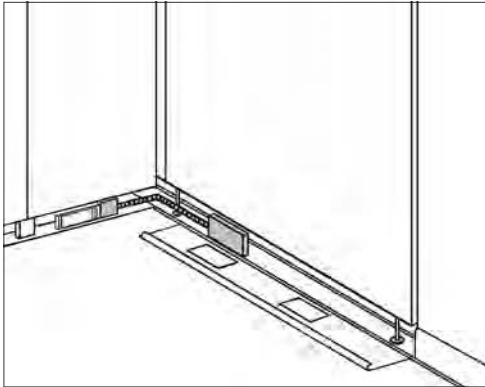

**PRODUCT INFORMATION**

**Features:**

- Connects directly to a Base Power Block (i2258) and adapts for connection to 8-wire systems
- Distributes up to 4 20-amp circuits
- Base electrical requires use of 4" wireway (i2130) with gypsum panels
- Base electrical requires use of 6" Vinyl Base (i2140)
- i2257 Exposed Systems Power Adapter has protected flexible conduit

**Specifiers:**

- Identify product number and length
  - Concealed - i2256
    - for 18" & 24" Systems Panels specify "A"
    - for 30" & 36" Systems Panels specify "B"
    - for 42" & 48" Systems Panels specify "C"
  - Exposed - i2257

Product Number & Length		
<b>Concealed</b>		
i2256.A	27"	\$343
i2256.B	36"	\$343
i2256.C	45"	\$343
<b>Exposed</b>		
i2257.A	72"	\$388
i2257.B	72"	\$464

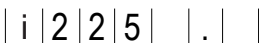

# i2258 BASE POWER BLOCK

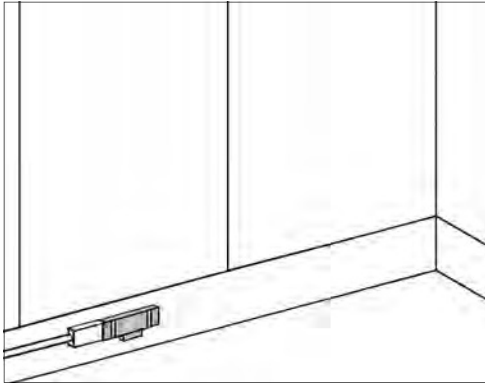

## PRODUCT INFORMATION

### Features:

- Provides distribution for Receptacles (i2259) or the Base Power Entry (i2250) on both sides of the panel
- Has connection points for four Power Jumpers (i2254) OR one Ceiling Power Entry (i2251) and three Power Jumpers (i2254)
- Distributes up to four 20-amp circuits
- UL listed and CSA certified
- Single block may be used when under panel with ceiling power entry
- Base electrical requires use of 4" wireway (i2130) with gypsum panels
- Base electrical requires use of 6" Vinyl Base (i2140)

### Specifiers:

- Identify single or double

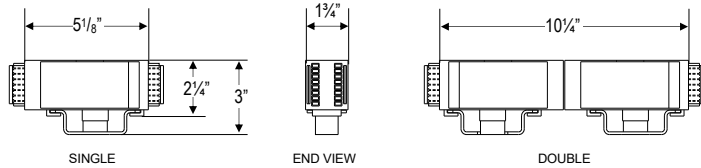

Product Number		
1	single	\$116
2	double	\$161

i 2 2 5 8 .



# i2259 RECEPTACLE, 4 CIRCUIT

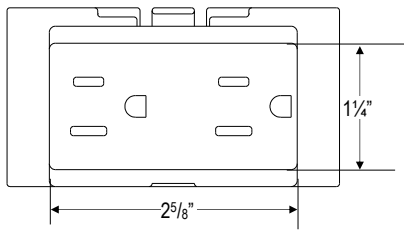
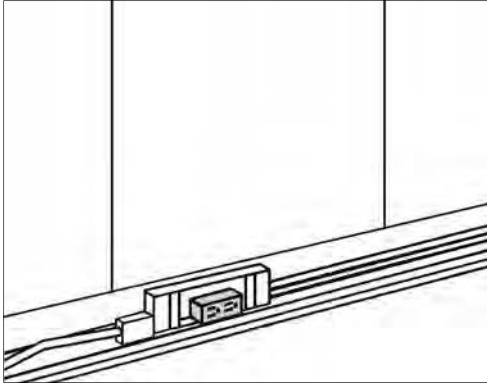

## PRODUCT INFORMATION

### Features:

- Locks into Base Power Block (i2258)
- Base electrical requires use of 4" wireway (i2130) with gypsum panels
- Base electrical requires use of 6" Vinyl Base (i2140)
- Includes 48" base trim piece with cut-out for receptacle
- Duplex receptacles are packaged 6 to the box  
Surge suppressed receptacles are packaged 1 to the box

### Specifiers:

- Identify receptacle
- Identify receptacle finish
- Identify base trim finish

Duplex Receptacle		
<b>A</b>	circuit a	\$317
<b>B</b>	circuit b	\$317
<b>C</b>	circuit c	\$317
<b>D</b>	circuit d, isolated	\$317
<b>BI</b>	circuit b, isolated	\$317
<b>CI</b>	circuit c, isolated	\$317
Simplex Receptacle Surge Suppression		
<b>BIS</b>	circuit b, isolated	\$217
<b>CIS</b>	circuit c, isolated	\$217
<b>DIS</b>	circuit d, isolated	\$217

Receptacle Finish	
<b>CL</b>	cool grey neutral (AN match)
<b>MC</b>	mocha
<b>WN</b>	warm grey neutral (CH match)
<b>SL</b>	slate
<b>BU</b>	black undertone

Trim Finish	
<b>B3B2B0</b>	alum
<b>9FA1A0</b>	anodized
<b>EDE9E0</b>	base white
<b>C0B7A8</b>	desert storm
<b>89989D</b>	epoxy blue
<b>4F4546</b>	espresso
<b>918D81</b>	glimmer bronze
<b>48494D</b>	graphite
<b>F3FDFF</b>	ice white
<b>323836</b>	matte slate
<b>B8AEA3</b>	metallic stone
<b>40403F</b>	midnight black
<b>201920</b>	onyx
<b>605746</b>	rust bronze
<b>636D6F</b>	space grey
<b>EAEBE6</b>	stone white
<b>A49E9E</b>	warm grey

i 2 2 5 9 .

# VERTICAL COMPONENTS

# i2310 WALL START

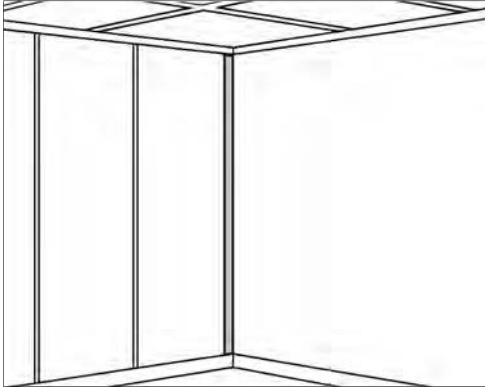

## PRODUCT INFORMATION

### Features:

- Extruded aluminum is used to capture and hold panel edge
- Can be field-cut and modified to fit architectural elements such as convector units and exterior glazing sills
- Backed with polyfoam light and sound seal gaskets
- Clipped at the top for attachment to the Ceiling Runner (i2110)

### Specifiers:

- Identify ceiling height
- Identify trim finish

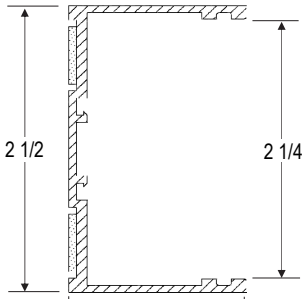

Ceiling Height		
108	9'0"	\$180
120	10'0"	\$194

Trim Finish	
B3B2B0	alum
9FA1A0	anodized
EDE9E0	base white
C0B7A8	desert storm
89989D	epoxy blue
4F4546	espresso
918D81	glimmer bronze
48494D	graphite
F3FDFF	ice white
323836	matte slate
B8AEA3	metallic stone
40403F	midnight black
201920	onyx
605746	rust bronze
636D6F	space grey
EAEBE6	stone white
A49E9E	warm grey

i 2 3 1 0 .

**i2311 TRUEABLE MODULAR WALL START**

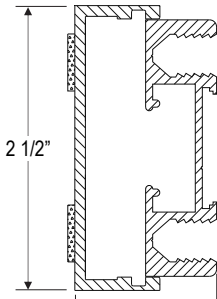
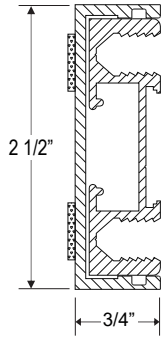

**PRODUCT INFORMATION**

**Features:**

- Structural, aluminum components
- Allows for out-of-plumb building wall construction
- Choice of aluminum finish color
- Part dimension: 7/8" - 1 3/8"
- Condition clips into ceiling runner, which is ordered separately

**Specifiers:**

- Identify correct ceiling height
- Identify aluminum trim finish color

Ceiling Height		
108	9'0"	\$318
120	10'0"	\$344

Trim Finish	
B3B2B0	alum
9FA1A0	anodized
EDE9E0	base white
C0B7A8	desert storm
89989D	epoxy blue
4F4546	espresso
918D81	glimmer bronze
48494D	graphite
F3FDFF	ice white
323836	matte slate
B8AEA3	metallic stone
40403F	midnight black
201920	onyx
605746	rust bronze
636D6F	space grey
EAEBE6	stone white
A49E9E	warm grey

i 2 3 1 1 .

**i2312 TRUEABLE DEEP MODULAR WALL START**

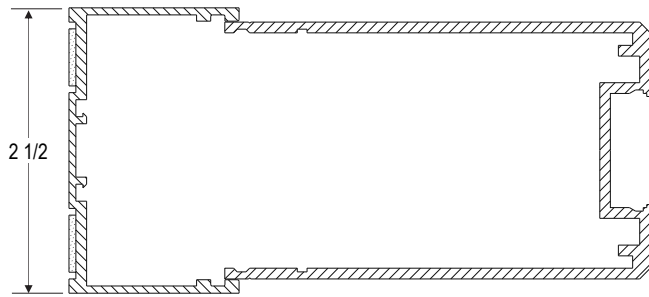
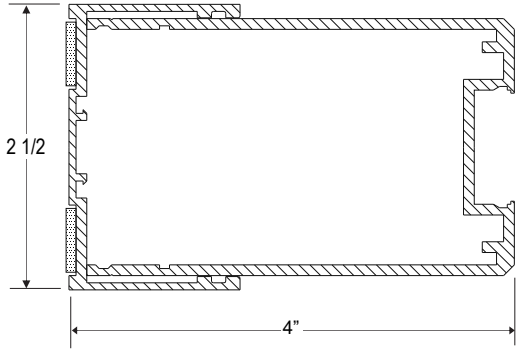

**PRODUCT INFORMATION**

**Features:**

- Structural, aluminum components
- Allows for out-of-plumb building wall construction
- Allows for vertical cabling or power
- Choice of aluminum finish color
- Part dimension: 4" - 5 3/8"
- Condition clips into ceiling runner, which is ordered separately

**Specifiers:**

- Identify correct ceiling height
- Identify aluminum trim finish color

Ceiling Height		
<b>108</b>	9'0"	\$558
<b>120</b>	10'0"	\$610

Trim Finish	
<b>B3B2B0</b>	alum
<b>9FA1A0</b>	anodized
<b>EDE9E0</b>	base white
<b>C0B7A8</b>	desert storm
<b>89989D</b>	epoxy blue
<b>4F4546</b>	espresso
<b>918D81</b>	glimmer bronze
<b>48494D</b>	graphite
<b>F3FDFF</b>	ice white
<b>323836</b>	matte slate
<b>B8AEA3</b>	metallic stone
<b>40403F</b>	midnight black
<b>201920</b>	onyx
<b>605746</b>	rust bronze
<b>636D6F</b>	space grey
<b>EAEBE6</b>	stone white
<b>A49E9E</b>	warm grey

i 2 3 1 2 .

# i2313 MODULAR INTERSECTION

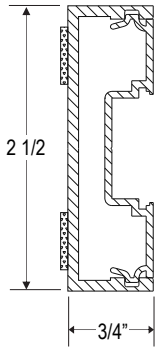

## PRODUCT INFORMATION

### Features:

- Structural, aluminum components
- Choice of aluminum finish color
- Ready to clip attach to adjacent panel
- Condition clips into ceiling runner, which is ordered separately

### Specifiers:

- Identify correct ceiling height
- Identify aluminum trim finish color

### Ceiling Height

<b>108</b>	9'0"	\$256
<b>120</b>	10'0"	\$274

### Trim Finish

<b>B3B2B0</b>	alum
<b>9FA1A0</b>	anodized
<b>EDE9E0</b>	base white
<b>C0B7A8</b>	desert storm
<b>89989D</b>	epoxy blue
<b>4F4546</b>	espresso
<b>918D81</b>	glimmer bronze
<b>48494D</b>	graphite
<b>F3FDFD</b>	ice white
<b>323836</b>	matte slate
<b>B8AEA3</b>	metallic stone
<b>40403F</b>	midnight black
<b>201920</b>	onyx
<b>605746</b>	rust bronze
<b>636D6F</b>	space grey
<b>EAEBE6</b>	stone white
<b>A49E9E</b>	warm grey

i 2 3 1 3 .

# i2314 MODULAR FINISHED END

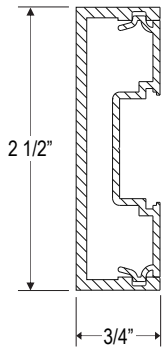

## PRODUCT INFORMATION

### Features:

- Structural, aluminum components
- Choice of aluminum finish color
- Ready to clip attach to adjacent panel
- Condition clips into ceiling runner, which is ordered separately

### Specifiers:

- Identify correct ceiling height
- Identify aluminum trim finish color

### Ceiling Height

<b>108</b>	9'0"	\$228
<b>120</b>	10'0"	\$247

### Trim Finish

<b>B3B2B0</b>	alum
<b>9FA1A0</b>	anodized
<b>EDE9E0</b>	base white
<b>C0B7A8</b>	desert storm
<b>89989D</b>	epoxy blue
<b>4F4546</b>	espresso
<b>918D81</b>	glimmer bronze
<b>48494D</b>	graphite
<b>F3FDFF</b>	ice white
<b>323836</b>	matte slate
<b>B8AEA3</b>	metallic stone
<b>40403F</b>	midnight black
<b>201920</b>	onyx
<b>605746</b>	rust bronze
<b>636D6F</b>	space grey
<b>EAEBE6</b>	stone white
<b>A49E9E</b>	warm grey

i | 2 | 3 | 1 | 4 | . | | | |

| | |

# i2315 OFF-MODULE CONNECTOR

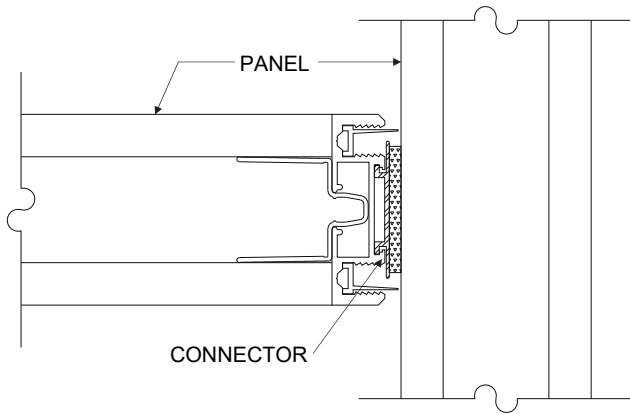

## PRODUCT INFORMATION

### Features:

- Semi-rigid plastic extrusion with heavy polyfoam sound and light seal
- Allows off-module connection to other Movable Wall panel faces at a 90° intersection
- Slides into end of aluminum-framed Movable Wall panel before panel installation
- Concealed once panel is installed
- Can be field cut

### Specifiers:

- Identify minimum panel height

Ceiling Height		
108	9'0"	\$61
120	10'0"	\$64

i 2 3 1 5 .



# i2316 MODULAR CONNECTOR, 2 WAY 120°

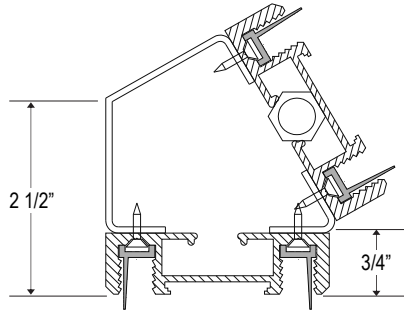

## PRODUCT INFORMATION

### Features:

- Structural, aluminum components
- Receives specified finish on 120° side
- Choice of aluminum finish color
- Ready to clip attach to adjacent panels
- Connector inserts into ceiling and floor runners, which are ordered separately

### Specifiers:

- Identify correct ceiling height
- Identify aluminum trim finish color

### Ceiling Height

108	9'0"	\$658
120	10'0"	\$706

### Trim Finish

B3B2B0	alum
9FA1A0	anodized
EDE9E0	base white
C0B7A8	desert storm
89989D	epoxy blue
4F4546	espresso
918D81	glimmer bronze
48494D	graphite
F3FDFF	ice white
323836	matte slate
B8AEA3	metallic stone
40403F	midnight black
201920	onyx
605746	rust bronze
636D6F	space grey
EAEBE6	stone white
A49E9E	warm grey

i 2 3 1 6 .

# i2317 MODULAR CONNECTOR, 3 WAY 120°

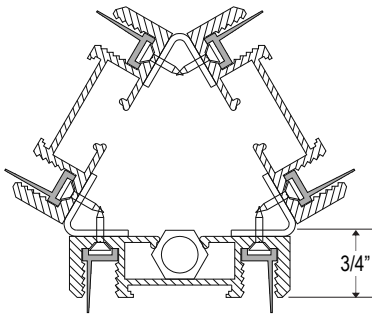

## PRODUCT INFORMATION

### Features:

- Structural, aluminum components
- Choice of aluminum finish color
- Ready to clip attach to adjacent panels
- Connector inserts into ceiling and floor runners, which are ordered separately

### Specifiers:

- Identify correct ceiling height
- Identify aluminum trim finish color

### Ceiling Height

108	9'0"	\$772
120	10'0"	\$830

### Trim Finish

B3B2B0	alum
9FA1A0	anodized
EDE9E0	base white
C0B7A8	desert storm
89989D	epoxy blue
4F4546	espresso
918D81	glimmer bronze
48494D	graphite
F3FDFF	ice white
323836	matte slate
B8AEA3	metallic stone
40403F	midnight black
201920	onyx
605746	rust bronze
636D6F	space grey
EAEBE6	stone white
A49E9E	warm grey

i 2 3 1 7 .

**i2318 ALUMINUM BASE, MODULAR CONNECTOR - 2 WAY 120°**

**i2331 ALUMINUM BASE, MODULAR CONNECTOR - 2 WAY 90° SQUARE**

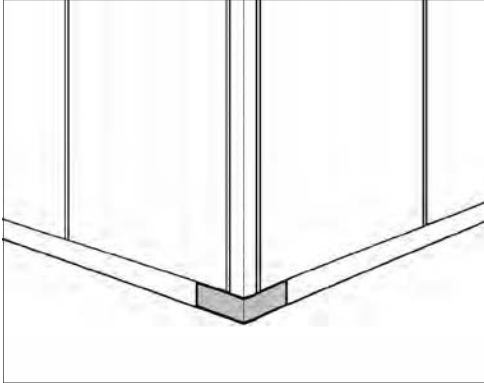

**PRODUCT INFORMATION**

**Features:**

- Pre-formed to trim base of modular connector
- Attaches to Narrow Floor Runner (i2122)
- Available in 4" height only

**Specifiers:**

- Identify product number
- Identify finish color

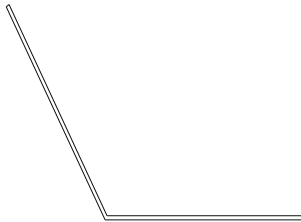

**2 Way 120°**

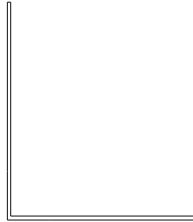

**2 Way 90° Square**

Product Number	
<b>2 Way 120°</b>	
i2318.4A	\$134
i2318.6A	\$151
<b>2 Way 90° Square</b>	
i2331.4A	\$134
i2331.6A	\$151

Trim Finish	
B3B2B0	alum
9FA1A0	anodized
EDE9E0	base white
C0B7A8	desert storm
89989D	epoxy blue
4F4546	espresso
918D81	glimmer bronze
48494D	graphite
F3FDFF	ice white
323836	matte slate
B8AEA3	metallic stone
40403F	midnight black
201920	onyx
605746	rust bronze
636D6F	space grey
EAEBE6	stone white
A49E9E	warm grey

i 2 3 . A

# i2322 COMPOUND FINISHED END, SQUARE

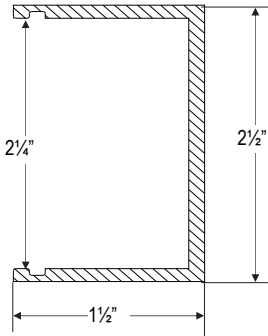
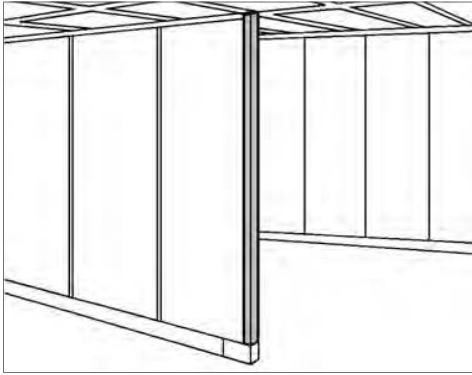

## PRODUCT INFORMATION

### Features:

- Trims the grooved or cut end of a panel at the end of a wall run
- Clip for attachment to the Ceiling Runner (i 2110) is included
- Order Vinyl Base Finished End (i 2323) separately; specify 1 for each finished end

### Specifiers:

- Identify ceiling height
- Identify trim finish

Ceiling Height		
108	9'	\$221
120	10'	\$241

Trim Finish	
B3B2B0	alum
9FA1A0	anodized
EDE9E0	base white
C0B7A8	desert storm
89989D	epoxy blue
4F4546	espresso
918D81	glimmer bronze
48494D	graphite
F3FDFF	ice white
323836	matte slate
B8AEA3	metallic stone
40403F	midnight black
201920	onyx
605746	rust bronze
636D6F	space grey
EAEBE6	stone white
A49E9E	warm grey

i 3 2 2 2 . . . . .

. . . . .

# i2330 MODULAR CONNECTOR, 2 WAY 90°

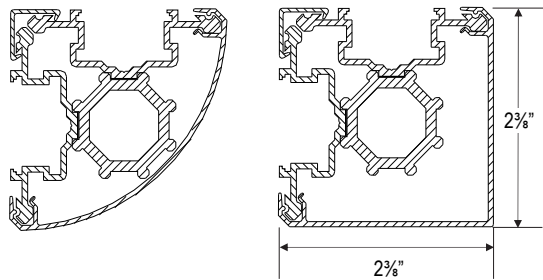
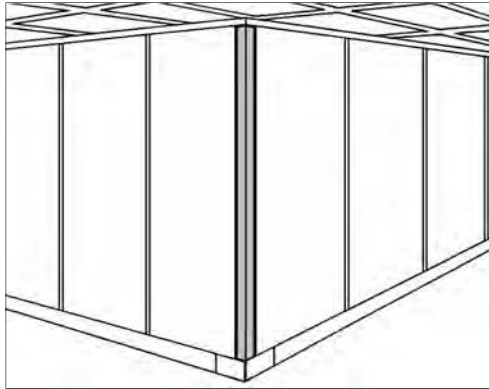

## PRODUCT INFORMATION

### Features:

- Connects two perpendicular wall runs
- Connects to the following elements:
  - Aluminum-framed panels
  - Concealed Connector, Panel to Corner (i2351)
  - Concealed Connector, Jamb to Corner (i2352) for door or glazing jambs
- Assembly screws, 1 ceiling runner trim plate (for radius only), and 1 clip are included
- Order Vinyl Base - Modular Connector (i2331) separately; specify 1 for each modular connector

### Specifiers:

- Identify product number & ceiling height
- Identify trim finish for radius only
- Identify surface finish
  - See appendix for vinyl styles and colors
  - Specify "0000" for unfinished units; units must be field-finished
- For "CUS" option - supply 3.3 linear yards (min) per 4 units

Height		
<b>Radius</b>		
<b>108.R</b>	9'	\$310
<b>120.R</b>	10'	\$328
<b>Square</b>		
<b>108.S</b>	9'	\$310
<b>120.S</b>	10'	\$328

Trim Finish	
<b>B3B2B0</b>	alum
<b>9FA1A0</b>	anodized
<b>EDE9E0</b>	base white
<b>C0B7A8</b>	desert storm
<b>89989D</b>	epoxy blue
<b>4F4546</b>	espresso
<b>918D81</b>	glimmer bronze
<b>48494D</b>	graphite
<b>F3FDFF</b>	ice white
<b>323836</b>	matte slate
<b>B8AEA3</b>	metallic stone
<b>40403F</b>	midnight black
<b>201920</b>	onyx
<b>605746</b>	rust bronze
<b>636D6F</b>	space grey
<b>EAEBE6</b>	stone white
<b>A49E9E</b>	warm grey

Surface Finish - Radius Only		
First 2 digits specify series, last 2 specify color		
<b>0000</b>	unfinished	+\$0
<b>CUS</b>	customer material	+\$8
<b>AD __</b>	adobe	+\$14
----	price category 1	+\$35
----	price category 2	+\$38
----	price category 3	+\$44
----	price category 4	+\$58
----	price category 5	+\$80
----	price category 6	+\$116
----	price category 7	+\$149

i 2 3 3 0 . . . . .

. . . . .

. . . . .

# i2332 MODULAR CONNECTOR, 2 WAY 135°

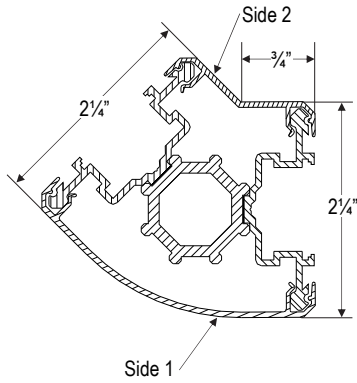
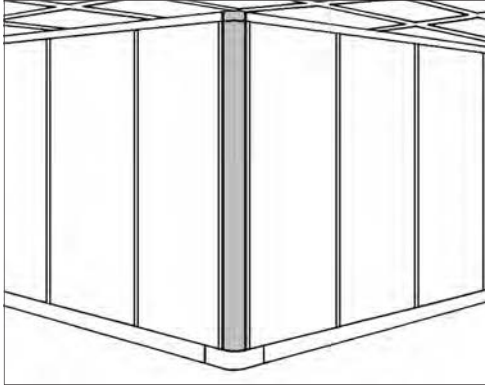

## PRODUCT INFORMATION

### Features:

- Connects two wall runs at 135°
- Connects to the following elements:
  - Aluminum-framed panels
  - Concealed Connector, Panel to Corner (i2351)
  - Concealed Connector, Jamb to Corner (i2352) for door or glazing jambs
- Assembly screws, 1 ceiling runner trim plate (for radius only), and 1 clip are included
- Order Vinyl Base Modular Connector (i2333) separately; specify 1 for each modular connector

### Specifiers:

- Identify ceiling height
- Identify trim finish
- Identify surface finish for side 1 and side 2  
See appendix for vinyl styles and colors  
Specify "0000" for unfinished units; units must be field-finished
- For "CUS" option - supply 3.3 linear yards (min) per 4 units

Ceiling Height		
108	9'	\$319
120	10'	\$337

Trim Finish	
B3B2B0	alum
9FA1A0	anodized
EDE9E0	base white
C0B7A8	desert storm
89989D	epoxy blue
4F4546	espresso
918D81	glimmer bronze
48494D	graphite
F3FDFF	ice white
323836	matte slate
B8AEA3	metallic stone
40403F	midnight black
201920	onyx
605746	rust bronze
636D6F	space grey
EAEBE6	stone white
A49E9E	warm grey

Surface Finish Side 1 / Side 2		
First 2 digits specify series, last 2 specify color		
0000	unfinished	+\$0
CUS	customer material	+\$8
AD __	adobe	+\$14
----	price category 1	+\$35
----	price category 2	+\$38
----	price category 3	+\$44
----	price category 4	+\$58
----	price category 5	+\$80
----	price category 6	+\$116
----	price category 7	+\$149

i 2 3 3 2 .

**i2334 MODULAR SPACER**

**i2338 MODULAR SPACER FOR SYSTEMS**

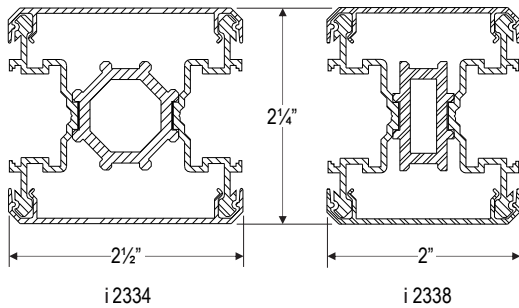
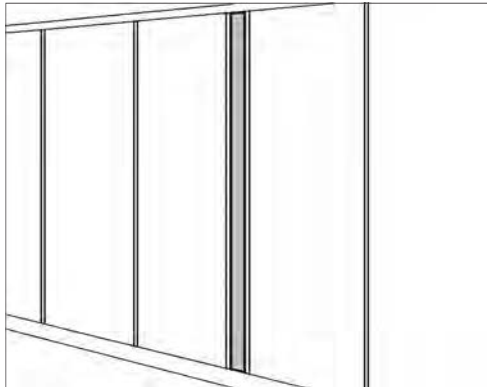

**PRODUCT INFORMATION**

**Features:**

- Connects two wall runs at 180°
- Connects to the following elements:
  - Aluminum-framed panels
  - Concealed Connector, Panel to Corner (i2351)
  - Wallstrip Connector (i2615)
  - Panel to Corner (i2611, i2661, i2711)
  - Concealed Connector, Jamb to Corner (i2352) for door or glazing jambs

**Specifiers:**

- Identify product number and ceiling height
- Identify surface finish for side 1 and side 2  
See appendix for vinyl styles and colors  
Specify "0000" for unfinished units; units must be field-finished
- For "CUS" option - supply 3.3 linear yards (min) per 4 units

Product Number & Height		
<b>i2334.108</b>	9'	\$318
<b>i2334.120</b>	10'	\$337
<b>for Systems</b>		
<b>i2338.108</b>	9'	\$278
<b>i2338.120</b>	10'	\$295

Surface Finish Side 1 / Side 2		
First 2 digits specify series, last 2 specify color		
<b>0000</b>	unfinished	+\$0
<b>CUS</b>	customer material	+\$8
<b>AD __</b>	adobe	+\$14
----	price category 1	+\$35
----	price category 2	+\$38
----	price category 3	+\$44
----	price category 4	+\$58
----	price category 5	+\$80
----	price category 6	+\$116
----	price category 7	+\$149

i | 2 | 3 | 3 | . | | | | | | | | | | | | | | | |

**i2335 MODULAR CONNECTOR, 3 WAY 90°**

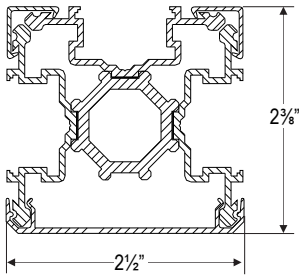
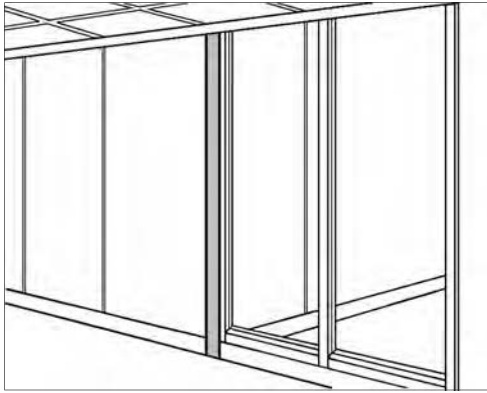

**PRODUCT INFORMATION**

**Features:**

- Connects three wall runs intersecting at 90°
- Connects to the following elements:
  - Aluminum-framed Panels
  - Concealed Connector, Panel to Corner (i2351)
  - Wallstrip Connector (i2615)
  - Panel to Corner (i2611, i2661, i2711)
  - Concealed Connector, Jamb to Corner (i2352) for door or glazing jambs

**Specifiers:**

- Identify ceiling height
- Identify surface finish
  - See appendix for vinyl styles and colors
  - Specify **"0000"** for unfinished units; units must be field-finished
- For **"CUS"** option - supply 3.3 linear yards (min) per 4 units

Ceiling Height		
108	9'	\$391
120	10'	\$414

Surface Finish		
First 2 digits specify series, last 2 specify color		
<b>CUS</b>	customer material	+\$8
<b>AD</b> __	adobe	+\$14
----	price category 1	+\$35
----	price category 2	+\$38
----	price category 3	+\$44
----	price category 4	+\$58
----	price category 5	+\$80
----	price category 6	+\$116
----	price category 7	+\$149

i 2 3 3 5 .



**i2337 MODULAR CONNECTOR, 3 WAY 135°**

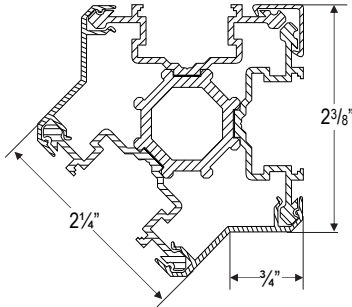
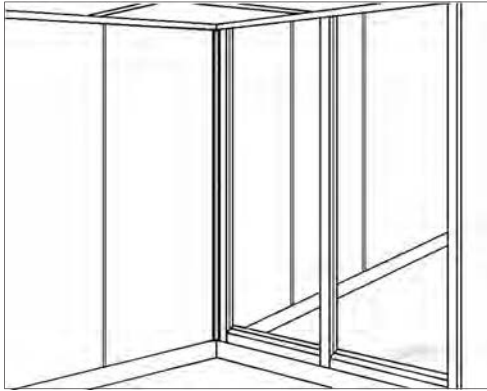

**PRODUCT INFORMATION**

**Features:**

- Connects three wall runs intersecting at 135°, 135° & 90°
- Connects to the following elements:
  - Aluminum-framed panels
  - Concealed Connector, Panel to Corner (i2351)
  - Wallstrip Connector (i2615)
  - Panel to Corner (i2611, i2661, i2711)
  - Concealed Connector, Jamb to Corner (i2352) for door or glazing jambs

**Specifiers:**

- Identify ceiling height
- Identify surface finish for side 1 and side 2  
See appendix for vinyl styles and colors  
Specify "0000" for unfinished units; units must be field-finished
- For "CUS" option - supply 3.3 linear yards (min) per 6 units

Ceiling Height		
108	9'	\$388
120	10'	\$412

Surface Finish Side 1 / Side 2		
First 2 digits specify series, last 2 specify color		
0000	unfinished	+\$0
CUS	customer material	+\$8
AD	adobe	+\$14
----	price category 1	+\$35
----	price category 2	+\$38
----	price category 3	+\$44
----	price category 4	+\$58
----	price category 5	+\$80
----	price category 6	+\$116
----	price category 7	+\$149

i 2 3 3 7 .

# i2340 COMPOUND CONNECTOR, 2 WAY 90°

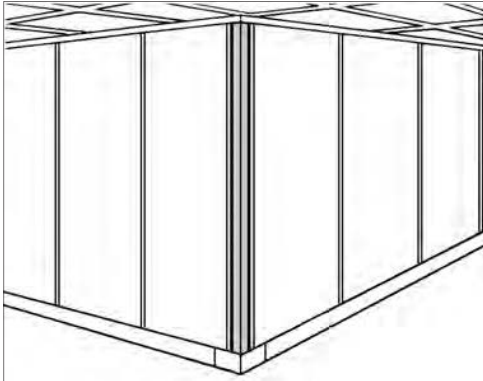

## PRODUCT INFORMATION

### Features:

- Connects panels or any combination of panels, Glazing Closures (i2445 & i2450), and Jamb Converter (i2354)
- Clipped at the top for attachment to the Ceiling Runner (i2110)
- Order Vinyl Base Compound Connector (i2341) separately; specify 1 for each compound connector

### Specifiers:

- Identify product number and ceiling height
- Identify trim finish

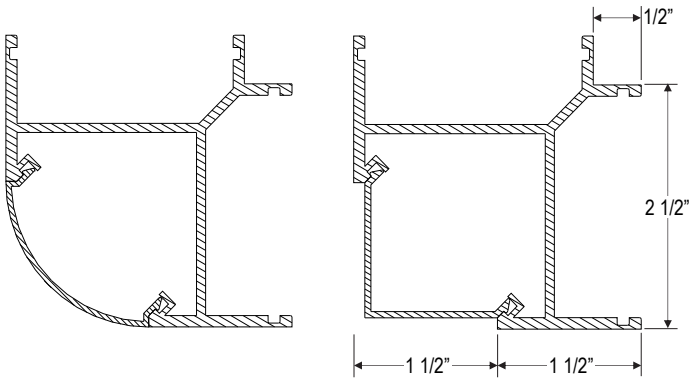

Product # & Ceiling Height		
<b>Radius</b>		
<b>108.R</b>	9'	\$359
<b>120.R</b>	10'	\$395
<b>Square</b>		
<b>108.S</b>	9'	\$359
<b>120.S</b>	10'	\$395

Trim Finish	
<b>B3B2B0</b>	alum
<b>9FA1A0</b>	anodized
<b>EDE9E0</b>	base white
<b>C0B7A8</b>	desert storm
<b>89989D</b>	epoxy blue
<b>4F4546</b>	espresso
<b>918D81</b>	glimmer bronze
<b>48494D</b>	graphite
<b>F3FDFF</b>	ice white
<b>323836</b>	matte slate
<b>B8AEA3</b>	metallic stone
<b>40403F</b>	midnight black
<b>201920</b>	onyx
<b>605746</b>	rust bronze
<b>636D6F</b>	space grey
<b>EAEBE6</b>	stone white
<b>A49E9E</b>	warm grey

i 2 3 4 0 . . . . .

. . .

# i2342 COMPOUND CONNECTOR, 2 WAY 135°

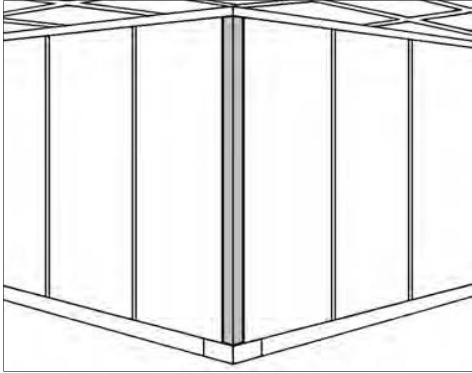

## PRODUCT INFORMATION

### Features:

- Connects panels or any combination of panels, Glazing Closures (i2445 & i2450), and Jamb Converter (i2354)
- Clipped at the top for attachment to the Ceiling Runner (i2110)
- Order Vinyl Base Compound Connector (i2343) separately; specify 1 for each compound connector

### Specifiers:

- Identify ceiling height
- Identify trim finish

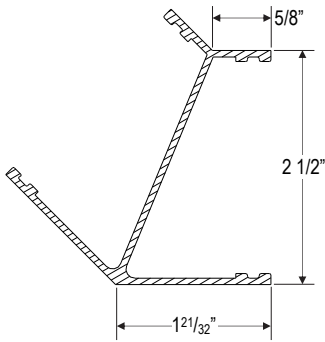

Ceiling Height		
108	9'	\$187
120	10'	\$204

Trim Finish	
B3B2B0	alum
9FA1A0	anodized
EDE9E0	base white
C0B7A8	desert storm
89989D	epoxy blue
4F4546	espresso
918D81	glimmer bronze
48494D	graphite
F3FDFF	ice white
323836	matte slate
B8AEA3	metallic stone
40403F	midnight black
201920	onyx
605746	rust bronze
636D6F	space grey
EAEBE6	stone white
A49E9E	warm grey

i 32 4 2 . | | | |

| |

# i2344 COMPOUND CONNECTOR, 180° TRANSITIONAL

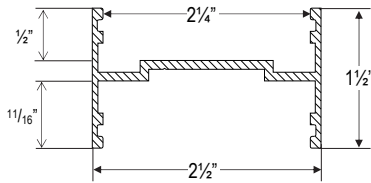
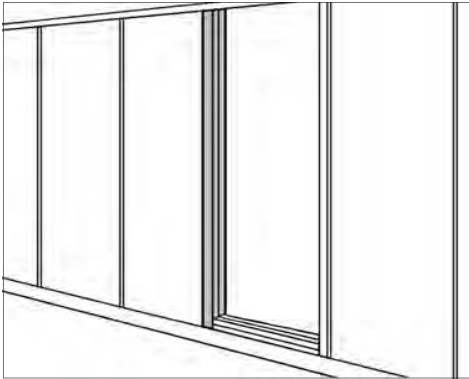

## PRODUCT INFORMATION

### Features:

- Aluminum extrusion permits a transition from full- to partial-panel modules
- Each side of extrusion accepts cut panel ends, snap-in compound connecting units, or glazing sections
- 9' and 10' units clipped at top for vertical attachment to Ceiling Runner (i 2110), clip not included with 12' unit
- Panels and other connectors sold separately

### Specifiers:

- Identify height/length
- Identify trim finish

Height/Length		
108	9'	\$169
120	10'	\$185
144	12'	\$216

Trim Finish	
B3B2B0	alum
9FA1A0	anodized
EDE9E0	base white
C0B7A8	desert storm
89989D	epoxy blue
4F4546	espresso
918D81	glimmer bronze
48494D	graphite
F3FDFF	ice white
323836	matte slate
B8AEA3	metallic stone
40403F	midnight black
201920	onyx
605746	rust bronze
636D6F	space grey
EAEBE6	stone white
A49E9E	warm grey

i 2 | 3 4 .4 |

| |

# i2345 COMPOUND CONNECTOR, 3 WAY 90°

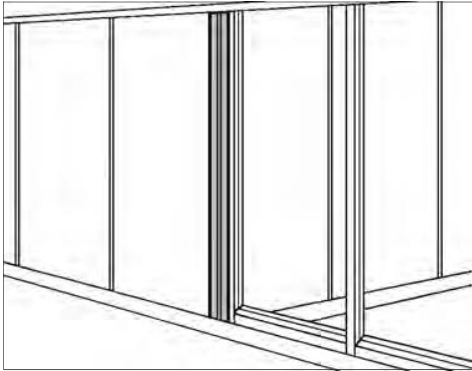

## PRODUCT INFORMATION

### Features:

- Aluminum extrusion connects 3 intersecting walls
- Each side can receive modular or non-modular panels as well as compound connectors and glazing or hang-on components
- Clipped at the top for attachment to the Ceiling Runner (i2110)

### Specifiers:

- Identify ceiling height
- Identify trim finish

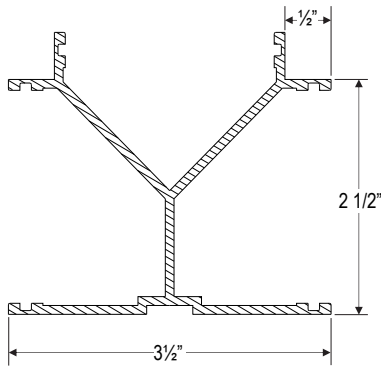

Ceiling Height		
108	9'	\$294
120	10'	\$324

Trim Finish	
B3B2B0	alum
9FA1A0	anodized
EDE9E0	base white
C0B7A8	desert storm
89989D	epoxy blue
4F4546	espresso
918D81	glimmer bronze
48494D	graphite
F3FDFD	ice white
323836	matte slate
B8AEA3	metallic stone
40403F	midnight black
201920	onyx
605746	rust bronze
636D6F	space grey
EAEBE6	stone white
A49E9E	warm grey

# i2350 CONCEALED CONNECTOR, PANEL TO PANEL

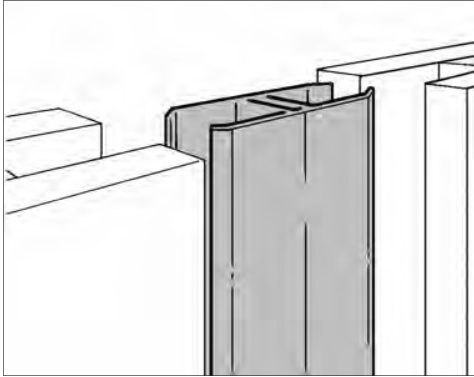

## PRODUCT INFORMATION

### Features:

- Vinyl extrusion connects one grooved gypsum panel to another grooved gypsum panel

### Specifiers:

- Identify ceiling height

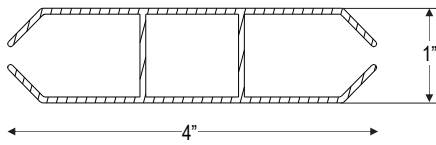

Ceiling Height		
108	9'	\$86
120	10'	\$95

i 2 | 3 5.0 |

**i2351 CONCEALED CONNECTOR, PANEL TO CORNER**

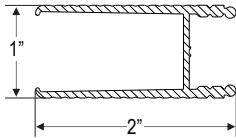
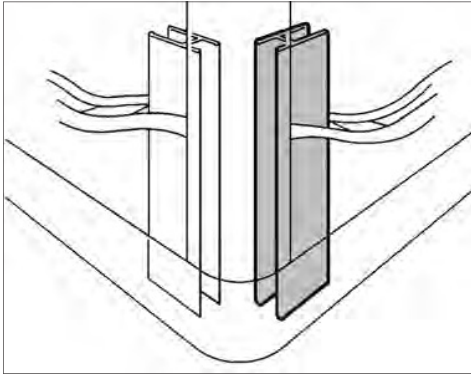

**PRODUCT INFORMATION**

**Features:**

- Aluminum extrusion connects a grooved gypsum panel to a modular corner, spacer or intersection
- Package contains 1

**Specifiers:**

- Identify ceiling height

Ceiling Height		
108	9'	\$106
120	10'	\$116

i 32 5 1 .

# i2352 CONCEALED CONNECTOR, JAMB TO CORNER

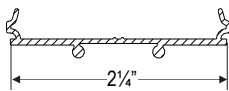
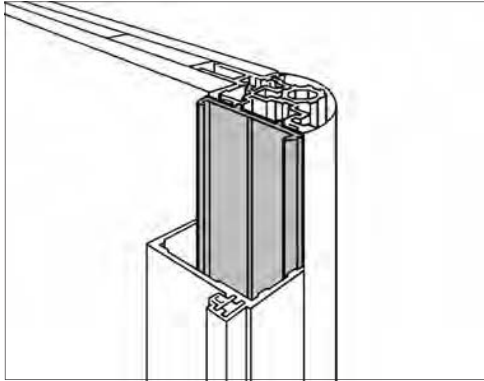

## PRODUCT INFORMATION

### Features:

- Aluminum extrusion connects door jamb, glazing jamb and vertical converters to modular corner connectors

**Note:** Will not connect to aluminum-framed panels

### Specifiers:

- Identify ceiling height
- Identify trim finish

Ceiling Height		
108	9'	\$67
120	10'	\$73

Trim Finish	
B3B2B0	alum
9FA1A0	anodized
EDE9E0	base white
C0B7A8	desert storm
89989D	epoxy blue
4F4546	espresso
918D81	glimmer bronze
48494D	graphite
F3FDFF	ice white
323836	matte slate
B8AEA3	metallic stone
40403F	midnight black
201920	onyx
605746	rust bronze
636D6F	space grey
EAEBE6	stone white
A49E9E	warm grey

i	2	3	5	.2		
---	---	---	---	----	--	--

--	--



# i2354 JAMB CONVERTER

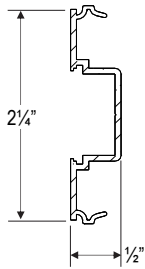
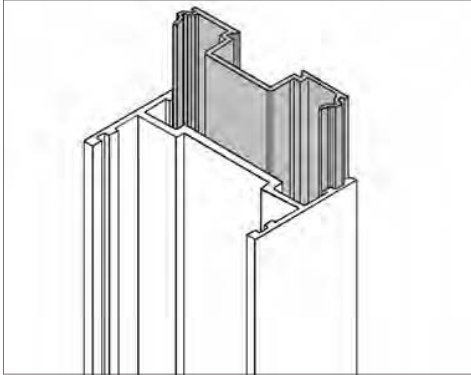

## PRODUCT INFORMATION

### Features:

- Aluminum extrusion snaps into either side of a compound connector and provides a receiver for a modular type connector

### Specifiers:

- Identify ceiling height
- Identify trim finish

Height			Trim Finish	
108	9'	\$85	B3B2B0	alum
120	10'	\$92	9FA1A0	anodized
			EDE9E0	base white
			COB7A8	desert storm
			89989D	epoxy blue
			4F4546	espresso
			918D81	glimmer bronze
			48494D	graphite
			F3FDFF	ice white
			323836	matte slate
			B8AEA3	metallic stone
			40403F	midnight black
			201920	onyx
			605746	rust bronze
			636D6F	space grey
			EAEBE6	stone white
			A49E9E	warm grey

i 32 5 4 .

# i2355 2-WAY TO 3-WAY CONVERTER KIT

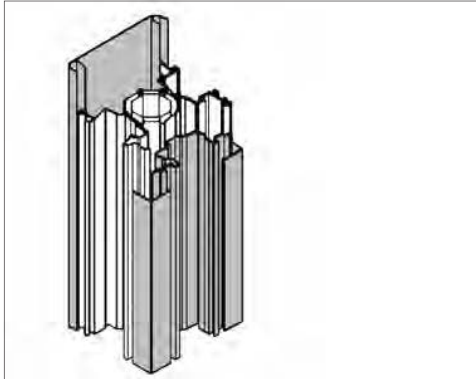

## PRODUCT INFORMATION

### Features:

- Converts a modular 2-Way to a modular 3-Way
- Includes concealed receiver part, two inside vinyl corner trims, and a finished flat vinyl trim cover

### Specifiers:

- Identify height
- Identify surface finish  
See appendix for vinyl styles and colors  
Specify "0000" for unfinished units; units must be field-finished
- For "CUS" option - supply 3.3 linear yards (min) per 4 units

Height		
108	9'	\$161
120	10'	\$173

Surface Finish		
First 2 digits specify series, last 2 specify color		
0000	unfinished	+\$0
CUS	customer material	+\$8
AD __	adobe	+\$14
----	price category 1	+\$35
----	price category 2	+\$38
----	price category 3	+\$44
----	price category 4	+\$58
----	price category 5	+\$80
----	price category 6	+\$116
----	price category 7	+\$149

i 2 3 5 . 5

# i2358 MODULAR CONNECTOR TRIM COVER

**RC** radius 90° cover

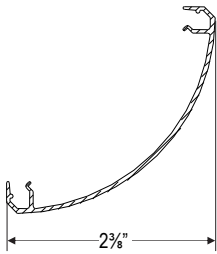

**SC** square 90° cover

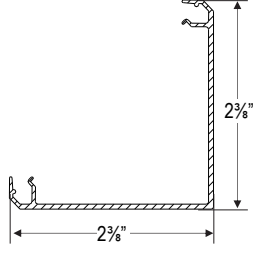

**IC** inside 135° cover

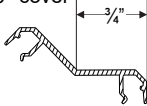

**FC** flat cover

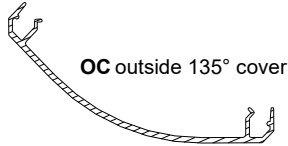
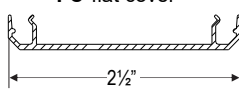

**OC** outside 135° cover

## PRODUCT INFORMATION

**Features:**

- Replacement vinyl covers snap fit onto existing modular components
- Comes in 10' height, trim to fit

**Specifiers:**

- Identify style
- Identify surface finish

Product Number		
i2358.120	10'	\$136

Cover Style	
<b>FC</b>	flat cover
<b>SC</b>	square 90° cover
<b>RC</b>	radius 90° cover
<b>OC</b>	outside 135° cover
<b>IC</b>	inside 135° cover

Surface Finish		
First 2 digits specify series, last 2 specify color		
<b>0000</b>	unfinished	+\$0
<b>CUS</b>	customer material	+\$8
<b>AD</b> __	adobe	+\$14
----	price category 1	+\$35
----	price category 2	+\$38
----	price category 3	+\$44
----	price category 4	+\$58
----	price category 5	+\$80
----	price category 6	+\$116
----	price category 7	+\$149

i 3 2 5 8 | 1 . 2 0

# i2359 ALUMINUM DOUBLE SPACER COVER

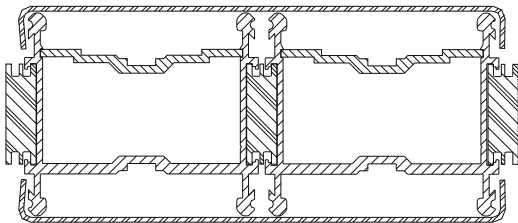

2 covers shown in use



part received

## PRODUCT INFORMATION

### Features:

- Aluminum components comes in 10' lengths
- Covers 5" wide side by side double spacer or power spacer units
- Spacer units are ordered separately
- Order 2 per condition

### Specifiers:

- Identify height
- Identify trim finish

Product Number	Trim Finish
i2359. \$247	B3B2B0 alum
	9FA1A0 anodized
	EDE9E0 base white
	C0B7A8 desert storm
	89989D epoxy blue
	4F4546 espresso
	918D81 glimmer bronze
	48494D graphite
	F3FDFF ice white
	323836 matte slate
	B8AEA3 metallic stone
	40403F midnight black
	201920 onyx
	605746 rust bronze
	636D6F space grey
	EAEBE6 stone white
	A49E9E warm grey

i 2 | 3 5.9 |

# i2370 3/4" WALL START

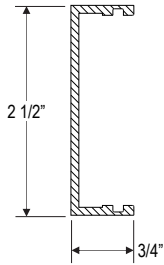
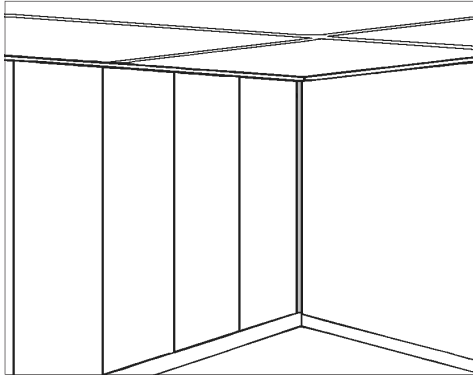

## PRODUCT INFORMATION

### Features:

- Provides 3/4" pocket to receive panels only

### Specifiers:

- Identify ceiling height
- Identify trim finish

Ceiling Height		
108	9'	\$136
120	10'	\$146

Trim Finish	
B3B2B0	alum
9FA1A0	anodized
EDE9E0	base white
C0B7A8	desert storm
89989D	epoxy blue
4F4546	espresso
918D81	glimmer bronze
48494D	graphite
F3FDFF	ice white
323836	matte slate
B8AEA3	metallic stone
40403F	midnight black
201920	onyx
605746	rust bronze
636D6F	space grey
EAEBE6	stone white
A49E9E	warm grey



# i2371 CHANNEL FILLER

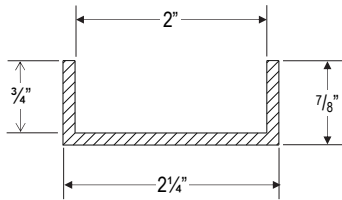
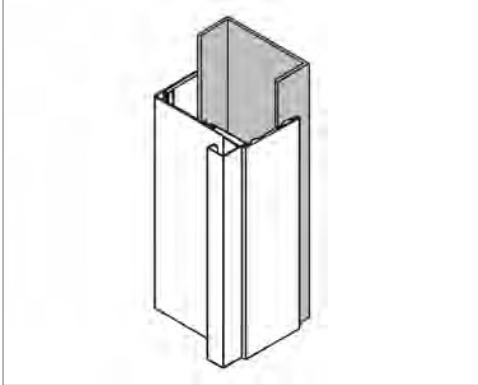

## PRODUCT INFORMATION

### Features:

- Provides an outside dimension of 2 1/4" finished channel to be sleeved by a compound connector or door jamb
- Allows an out-of-plumb building partition connection

### Specifiers:

- Identify height
- Identify trim finish

Height		
108	9'	\$161
120	10'	\$178

Trim Finish	
B3B2B0	alum
9FA1A0	anodized
EDE9E0	base white
C0B7A8	desert storm
89989D	epoxy blue
4F4546	espresso
918D81	glimmer bronze
48494D	graphite
F3FDFF	ice white
323836	matte slate
B8AEA3	metallic stone
40403F	midnight black
201920	onyx
605746	rust bronze
636D6F	space grey
EAEBE6	stone white
A49E9E	warm grey

i	2	3	7.1		
---	---	---	-----	--	--

--	--

# i2372 1" MODULAR FILLER

## PRODUCT INFORMATION

### Features:

- Aluminum component comes in 10' length
- 1" wide attaches to modular panel or connector for special fill applications

### Specifiers:

- Identify trim finish

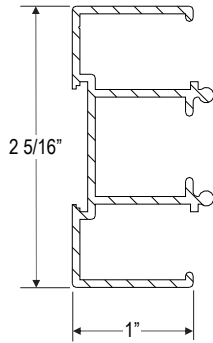

Product Number	Trim Finish
e2372. \$170	B3B2B0 alum
	9FA1A0 anodized
	EDE9E0 base white
	C0B7A8 desert storm
	89989D epoxy blue
	4F4546 espresso
	918D81 glimmer bronze
	48494D graphite
	F3FDFF ice white
	323836 matte slate
	B8AEA3 metallic stone
	40403F midnight black
	201920 onyx
	605746 rust bronze
	636D6F space grey
	EAEBE6 stone white
	A49E9E warm grey



# i2373 1/2" MODULAR FILLER

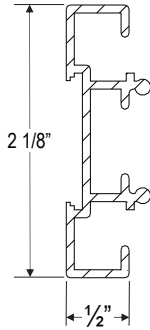

## PRODUCT INFORMATION

### Features:

- Aluminum component comes in 10' length
- 1/2" wide attaches to modular panel or connector for special fill applications

### Specifiers:

- Identify trim finish

Product Number		Trim Finish
i2373.	\$134	<b>B3B2B0</b> alum <b>9FA1A0</b> anodized <b>EDE9E0</b> base white <b>C0B7A8</b> desert storm <b>89989D</b> epoxy blue <b>4F4546</b> espresso <b>918D81</b> glimmer bronze <b>48494D</b> graphite <b>F3FDFF</b> ice white <b>323836</b> matte slate <b>B8AEA3</b> metallic stone <b>40403F</b> midnight black <b>201920</b> onyx <b>605746</b> rust bronze <b>636D6F</b> space grey <b>EAEBE6</b> stone white <b>A49E9E</b> warm grey

i	2	3	7	3		
---	---	---	---	---	--	--



- i2380 MODULAR GLASS CORNER PANEL, 2 WAY 120°**
- i2381 MODULAR GLASS CORNER PANEL, 2 WAY 90°**
- i2382 MODULAR GLASS CORNER PANEL, 2 WAY 135°**

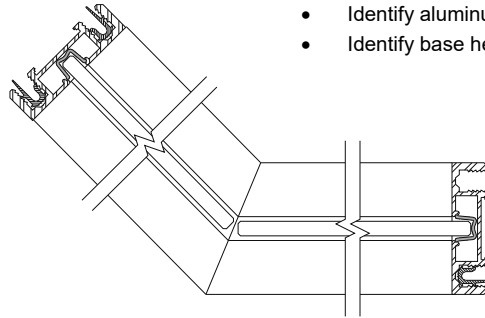
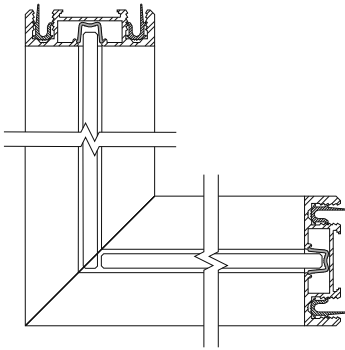
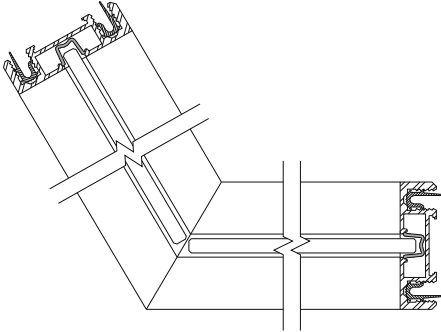

**PRODUCT INFORMATION**

**Features:**

- Structural, aluminum and glass assembly
- Choice of aluminum finish color
- Ready to clip attach to modular components
- Connector inserts into ceiling and floor runners, which are ordered separately

**Specifiers:**

- Identify product number
- Identify correct ceiling height
- Identify linear panel width
- Identify glass finish  
See appendix for "FX" custom applied film options
- Identify aluminum trim finish color
- Identify base height

Product Number	Ceiling Height	Panel Width	Glass Finish	Trim Finish	
<b>i2380</b> Modular Glass Corner Panel 2 Way 120	<b>96</b> 8'0" \$1872	<b>18</b> 2 - 9" legs +\$0	<b>GR</b> 1/4" clear +\$632	<b>B3B2B0</b> alum	
	<b>97</b> 8'1" \$1872	<b>24</b> 2 - 12" legs +\$54	<b>GP</b> 1/4" pattern +\$863	<b>9FA1A0</b> anodized	
	<b>98</b> 8'2" \$1872	<b>30</b> 2 - 15" legs +\$112	<b>GS</b> 1/4" laminated +\$1757	<b>EDE9E0</b> base white	
	<b>99</b> 8'3" \$1872	<b>36</b> 2 - 18" legs +\$169	<b>GG</b> 1/4" frosted +\$2204	<b>C0B7A8</b> desert storm	
	<b>i2381</b> Modular Glass Corner Panel 2 Way 90	<b>100</b> 8'4" \$1872	<b>42</b> 2 - 21" legs +\$221	<b>GL</b> 1/4" white lam +\$2383	<b>89989D</b> epoxy blue
		<b>101</b> 8'5" \$1872	<b>48</b> 2 - 24" legs +\$278	<b>GC</b> 1/2" clear temp +\$1668	<b>4F4546</b> espresso
		<b>102</b> 8'6" \$1872		<b>GJ</b> 1/2" laminated +\$3341	<b>918D81</b> glimmer bronze
		<b>103</b> 8'7" \$1872		<b>GU</b> 1/2" frosted +\$3865	<b>48494D</b> graphite
		<b>104</b> 8'8" \$1872		<b>GV</b> 1/2" white lam +\$4363	<b>F3DFDF</b> ice white
		<b>105</b> 8'9" \$1872		<b>GW</b> 3/8" clear temp +\$1150	<b>323836</b> matte slate
<b>106</b> 8'10" \$1872			<b>GY</b> 3/8" laminated +\$2466	<b>B8AEA3</b> metallic stone	
<b>107</b> 8'11" \$1872			<b>GZ</b> 3/8" frosted +\$3035	<b>40403F</b> midnight black	
<b>108</b> 9'0" \$1872			<b>GI</b> 3/8" white lam +\$3986	<b>201920</b> onyx	
<b>i2382</b> Modular Glass Corner Panel 2 Way 135		<b>109</b> 9'1" \$1936		<b>GX</b> custom or CUS	<b>605746</b> rust bronze
	<b>110</b> 9'2" \$1936		<b>FX</b> custom applied film	<b>636D6F</b> space grey	
	<b>111</b> 9'3" \$1936			<b>EAE9E6</b> stone white	
	<b>112</b> 9'4" \$1936			<b>A49E9E</b> warm grey	
	<b>113</b> 9'5" \$1936				
	<b>114</b> 9'6" \$1936				
	<b>115</b> 9'7" \$1936				
	<b>116</b> 9'8" \$1936				
	<b>117</b> 9'9" \$1936				
	<b>118</b> 9'10" \$1936				
<b>119</b> 9'11" \$1936					
<b>120</b> 10'0" \$1936					

Base Height	
<b>00</b>	No Base
<b>04</b>	4"
<b>06</b>	6"

# GLAZING COMPONENTS

# i2410 SIDE LIGHT KIT - 12", 24" OR 48" WIDE

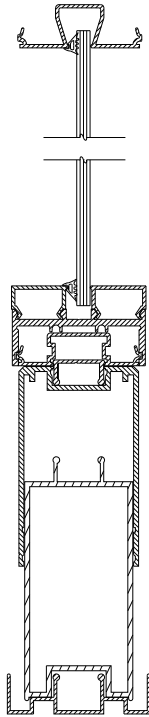
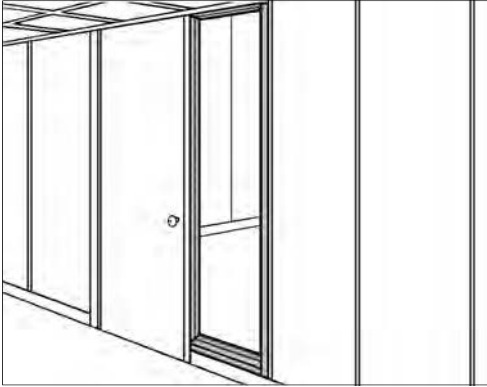

## PRODUCT INFORMATION

### Features:

- Field-built kit includes:
  1. Glazing closure for the Ceiling Runner (i2110) and door jamb
  2. Glazing jamb that can connect to a wall panel
  3. Glazing sill with an adjustable leveling base that snaps onto the Floor Runner (i2120)
- Base has a total height adjustment of 1½"
- Includes clips, screws and glazing bead
- Does **not** include glazing
- Only one Side Light can be used adjacent to door jambs or square finished end. Side Lights can not be ganged together to create continuous runs of glass
- Can be field-cut to narrower width
- Vinyl base and floor runner sold separately

### Specifiers:

- Identify ceiling height and side light width
- Identify trim finish

### Ceiling Height & Side Light Width

<b>108.12</b>	9'x12"	\$468
<b>120.12</b>	10'x12"	\$500
<b>108.24</b>	9'x24"	\$529
<b>120.24</b>	10'x24"	\$560
<b>108.48</b>	9'x48"	\$648
<b>120.48</b>	10'x48"	\$680

### Trim Finish

<b>B3B2B0</b>	alum
<b>9FA1A0</b>	anodized
<b>EDE9E0</b>	base white
<b>C0B7A8</b>	desert storm
<b>89989D</b>	epoxy blue
<b>4F4546</b>	espresso
<b>918D81</b>	glimmer bronze
<b>48494D</b>	graphite
<b>F3FDFF</b>	ice white
<b>323836</b>	matte slate
<b>B8AEA3</b>	metallic stone
<b>40403F</b>	midnight black
<b>201920</b>	onyx
<b>605746</b>	rust bronze
<b>636D6F</b>	space grey
<b>EAEBE6</b>	stone white
<b>A49E9E</b>	warm grey

i 2 4 1 0 . . . . .

. . . . .

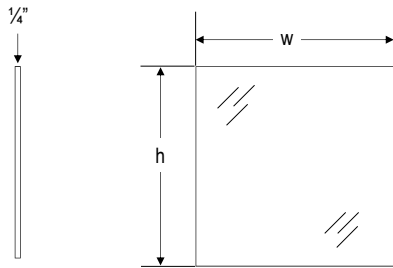
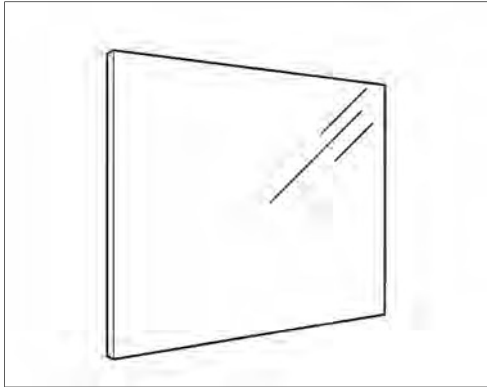

**PRODUCT INFORMATION**

**Features:**

- Pre-cut clear safety glass units are cut to fit standard Side Light (i2410) units or can be cut to fit custom openings
- Order glazing framing or Side Lights and glazing assembly separately
- **XX.24** are custom sizes up to 24" width  
**XX.48** are custom sizes up to 48" width

**Specifiers:**

- Identify size
- Orders for less than five pieces any size, combined, require crating option

Product Number	Size	Crating
<b>i2415</b> \$887	<b>108.12</b> 9'x12" <b>120.12</b> 10'x12"	<b>NA</b> <b>CR</b> under 5 pieces +\$96
	<b>108.24</b> 9'x24" <b>120.24</b> 10'x 24" <b>XX.24</b>	
	<b>108.48</b> 9'x48"    +\$863 <b>120.48</b> 10'x48"    +\$863 <b>XX.48</b> +\$863	

i 2 4 1 5 .

   .

   .

# i2420 GLAZING SILL, ADJUSTABLE HEIGHT

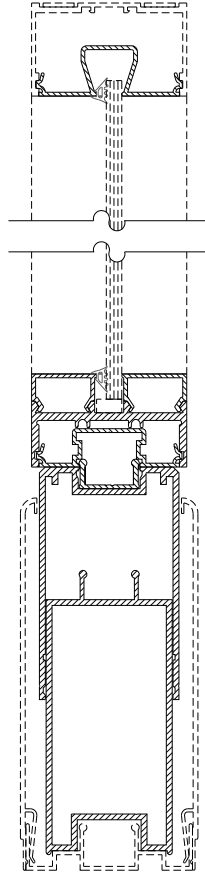
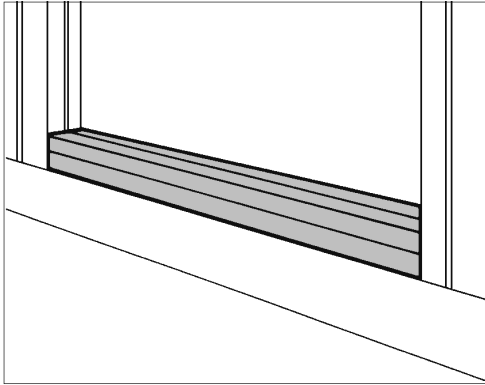

## PRODUCT INFORMATION

### Features:

- 12' assembly includes:
  1. Glazing closure for the Ceiling Runner (i2110)
  2. Sill with snap-on glazing stops
  3. Adjustable leveling base that snaps into Floor Runner (i2120)
- Base has a total height adjustment of 1½"
- Order Glazing Bead (i2460) separately
- Glass not included

### Specifiers:

**Note:** Measure overall length of glazing run and round up to next 2' increment (i.e. a 12'10" run rounds up to 14'.) Add up all rounded glazing run lengths and divide by 12 for order quantity

- Identify trim finish

Product Number	Price	Trim Finish
i2420	\$1820	B3B2B0 alum
		9FA1A0 anodized
		EDE9E0 base white
		COB7A8 desert storm
		89989D epoxy blue
		4F4546 espresso
		918D81 glimmer bronze
		48494D graphite
		F3FDFF ice white
		323836 matte slate
		B8AEA3 metallic stone
		40403F midnight black
		201920 onyx
		605746 rust bronze
		636D6F space grey
		EAEBE6 stone white
		A49E9E warm grey

i 2 4 2 0 .

□ □

**i2421 GLAZING SILL, FIXED HEIGHT**

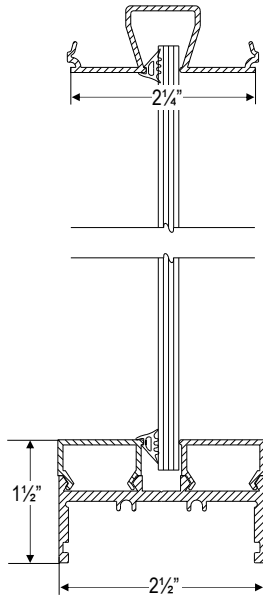
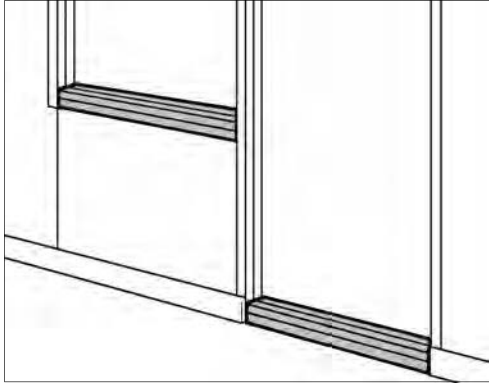

**PRODUCT INFORMATION**

**Features:**

- 12' assembly includes:
  1. Glazing closure for the Ceiling Runner (i2110)
  2. Sill with snap-on glazing stops
- Order Glazing Bead (i2460) separately
- Glass not included

- Note: 1.** If sill is used in horizontal mullion application, order shallow snap-in closure separately. Contact Regional Wall Service Center for order information
- Note: 2.** In full-height applications, order Vinyl Base End Plug (i2141) separately
- Note: 3.** Add "D" clips (i2461) for multiple cut uses

**Specifiers:**

**Note:** Measure overall length of glazing run and round up to next 2' increment (i.e. a 12'10" run rounds up to 14'.) Add up all rounded glazing run lengths and divide by 12 for order quantity

- Identify trim finish

Product Number	Trim Finish
i2421      \$496	B3B2B0 alum
	9FA1A0 anodized
	EDE9E0 base white
	C0B7A8 desert storm
	89989D epoxy blue
	4F4546 espresso
	918D81 glimmer bronze
	48494D graphite
	F3FDFF ice white
	323836 matte slate
	B8AEA3 metallic stone
	40403F midnight black
	201920 onyx
	605746 rust bronze
	636D6F space grey
	EAEBE6 stone white
	A49E9E warm grey

i | 2 | 4 | 2 | 1 | . |

  |  |

# i2430 GLAZING JAMB

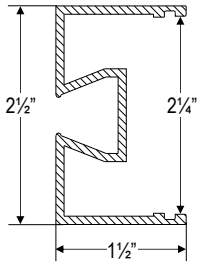
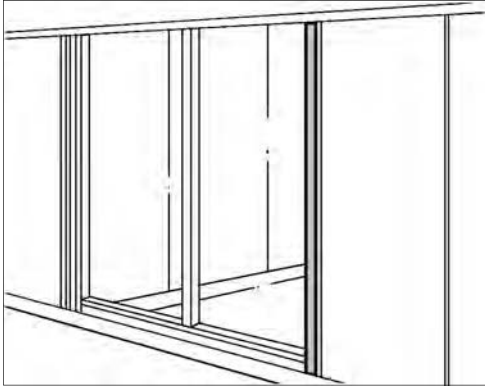

## PRODUCT INFORMATION

### Features:

- Holds and conceals the cut edge of a gypsum panel or connects to a Jamb Converter (i2354)
- Clipped for attachment to the Ceiling Runner (i2110)
- Assembly Clips and screws are included
- Order Glazing Bead (i2460) separately

### Specifiers:

- Identify ceiling height
- Identify trim finish

Ceiling Height		
108	9'	\$226
120	10'	\$247

Trim Finish	
B3B2B0	alum
9FA1A0	anodized
EDE9E0	base white
C0B7A8	desert storm
89989D	epoxy blue
4F4546	espresso
918D81	glimmer bronze
48494D	graphite
F3FDFF	ice white
323836	matte slate
B8AEA3	metallic stone
40403F	midnight black
201920	onyx
605746	rust bronze
636D6F	space grey
EAEBE6	stone white
A49E9E	warm grey

i 2 4 3 0 . | | | | |

| |

# i2440 GLAZING MULLION

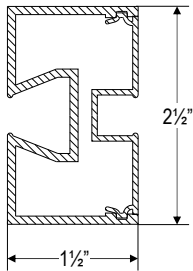
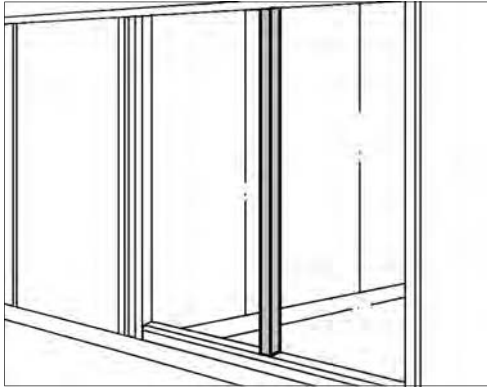

## PRODUCT INFORMATION

### Features:

- Accepts glazing on both sides
- Clipped for attachment to the Ceiling Runner (i2110)
- Assembly clips and screws are included
- Order Glazing Bead (i2460) separately

**Note:** Check local code authority for applications  
Maximum of 5' of glazing between mullions

### Specifiers:

- Identify ceiling height
- Identify trim finish

Ceiling Height		
108	9'	\$298
120	10'	\$319

Trim Finish	
B3B2B0	alum
9FA1A0	anodized
EDE9E0	base white
C0B7A8	desert storm
89989D	epoxy blue
4F4546	espresso
918D81	glimmer bronze
48494D	graphite
F3FDFF	ice white
323836	matte slate
B8AEA3	metallic stone
40403F	midnight black
201920	onyx
605746	rust bronze
636D6F	space grey
EAEBE6	stone white
A49E9E	warm grey

i 2 4 4 0 .



# i2445 SHALLOW GLAZING CLOSURE

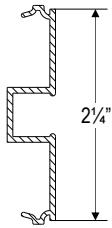
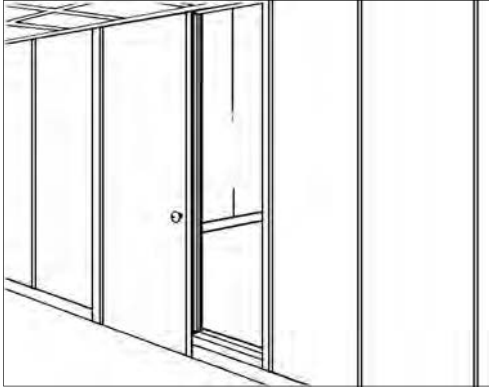

## PRODUCT INFORMATION

### Features:

- Accepts glazing and snaps into a door jamb, Wall Start (i2310) or compound connector
- Used vertically or horizontally
- Order Glazing Bead (i2460) separately

### Specifiers:

- Identify length
- Identify trim finish

Length		
108	9'	\$91
120	10'	\$100
144	12'	\$115

Trim Finish	
B3B2B0	alum
9FA1A0	anodized
EDE9E0	base white
C0B7A8	desert storm
89989D	epoxy blue
4F4546	espresso
918D81	glimmer bronze
48494D	graphite
F3FDFF	ice white
323836	matte slate
B8AEA3	metallic stone
40403F	midnight black
201920	onyx
605746	rust bronze
636D6F	space grey
EAEBE6	stone white
A49E9E	warm grey

i 2 4 4 5 .

# i2450 GLAZING CLOSURE

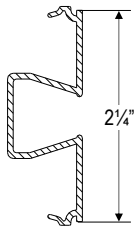
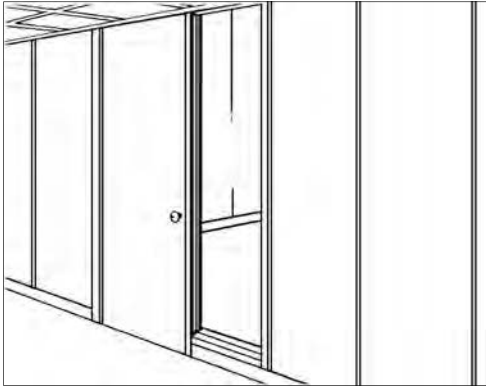

## PRODUCT INFORMATION

### Features:

- Accepts glazing and snaps into a door jamb, Wall Start (i2310) or compound connector
- Order Glazing Bead (i2460) separately

### Specifiers:

- Identify ceiling height
- Identify trim finish

Ceiling Height		
108	9'	\$106
120	10'	\$115

Trim Finish	
B3B2B0	alum
9FA1A0	anodized
EDE9E0	base white
C0B7A8	desert storm
89989D	epoxy blue
4F4546	espresso
918D81	glimmer bronze
48494D	graphite
F3FDFF	ice white
323836	matte slate
B8AEA3	metallic stone
40403F	midnight black
201920	onyx
605746	rust bronze
636D6F	space grey
EAEBE6	stone white
A49E9E	warm grey

i 2 4 5 0 .

**i2460 GLAZING BEAD**

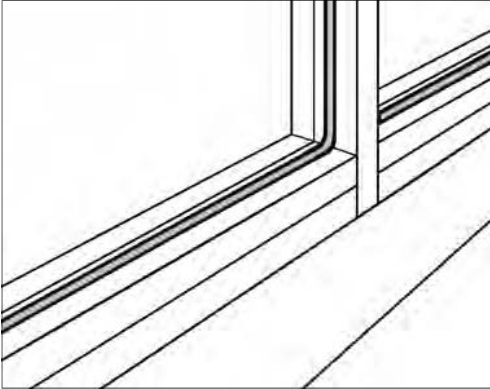

**PRODUCT INFORMATION**

**Features:**

- Flexible bead is sized for 1/4" thick glazing for use on all glazing components
- Each roll is 250' long

**Note:** Measure perimeter of each glazing section to calculate total linear feet required. Use Glazing Bead on 1 side of glazing only

**Specifiers:**

- Identify color

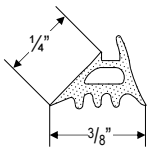

Product Number		Color	
i 2460	\$187	<b>BK</b>	black
		<b>GY</b>	grey

i | 2 | 4 | 6 | 0 | . |

  |   |

# i2461 GLAZING SILL D CLIPS

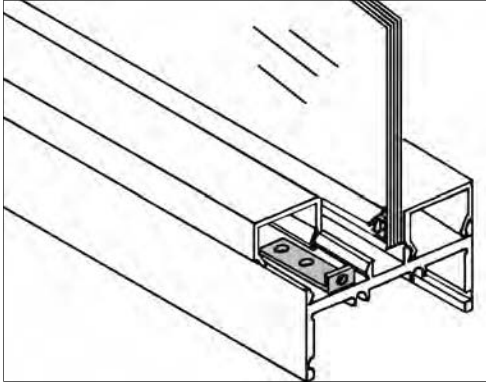

## PRODUCT INFORMATION

### Features:

- These extra clips are required when trimming i2420 Glazing Sill, Adjustable Height and i2421 Glazing Sill, Fixed Height for multiple openings.
- Sills require 4 clips per opening
- D clips come in quantities of 50 per box

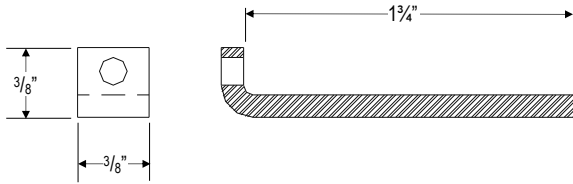

Product Number	
i2461	\$192

i 2 4 6 1 .

# CASED OPENINGS, DOOR FRAMES, DOOR PANELS & DOORS

# i2501 FULL HEIGHT MODULAR CASED OPENING

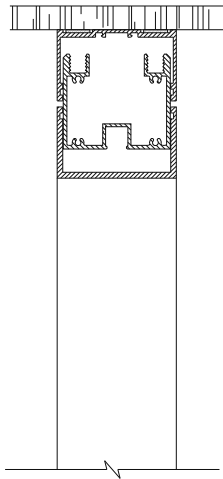
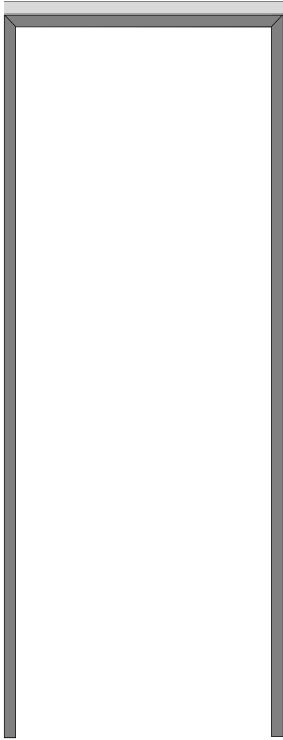

## PRODUCT INFORMATION

### Features:

- Comes with installation clips and screws
- On-site trimming of frame may be required. 1" excess is provided at bottom to accommodate floor-to-ceiling variations

### Specifiers:

- Identify correct ceiling height
- Identify cased opening width
- Vertical opening dimensions are 1½" less than specified ceiling height.
- Identify aluminum trim finish color
- Identify base height

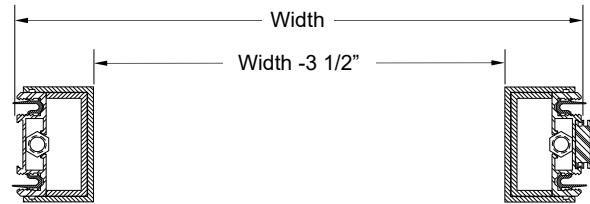

Ceiling Height		
96	8'0"	\$966
97	8'1"	\$966
98	8'2"	\$966
99	8'3"	\$966
100	8'4"	\$966
101	8'5"	\$966
102	8'6"	\$966
103	8'7"	\$966
104	8'8"	\$966
105	8'9"	\$966
106	8'10	\$966
107	8'11	\$966
108	9'0"	\$966
109	9'1"	\$1008
110	9'2"	\$1008
111	9'3"	\$1008
112	9'4"	\$1008
113	9'5"	\$1008
114	9'6"	\$1008
115	9'7"	\$1008
116	9'8"	\$1008
117	9'9"	\$1008
118	9'10"	\$1008
119	9'11"	\$1008
120	10'0"	\$1008

Width		
24	24"	+\$0
30	30"	+\$23
36	36"	+\$43
39	39.5"	+\$66
42	42"	+\$66
48	48"	+\$86

Trim Finish	
B3B2B0	alum
9FA1A0	anodized
EDE9E0	base white
C0B7A8	desert storm
89989D	epoxy blue
4F4546	espresso
918D81	glimmer bronze
48494D	graphite
F3FDFF	ice white
323836	matte slate
B8AEA3	metallic stone
40403F	midnight black
201920	onyx
605746	rust bronze
636D6F	space grey
EAEBE6	stone white
A49E9E	warm grey

Base Height	
00	No Base
04	4"
06	6"

i | 2 | 5 | 0 | 1 | . | | | | |

| | |

| | |

| | |

# i2502 MODULAR CASED OPENING WITH GLASS

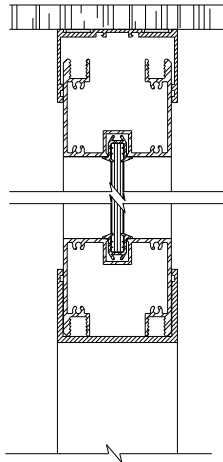

## PRODUCT INFORMATION

### Features:

- On-site trimming of frames may be required. 1" excess is provided at bottom to accommodate floor-to-ceiling variations
- Glass transom sill height matches standard 86" sill height on wall panels

### Specifiers:

- Identify correct ceiling height
  - Identify cased opening width
  - Identify aluminum trim finish color
  - Identify base height
  - Identify glass finish
- See appendix for "FX" custom applied film options

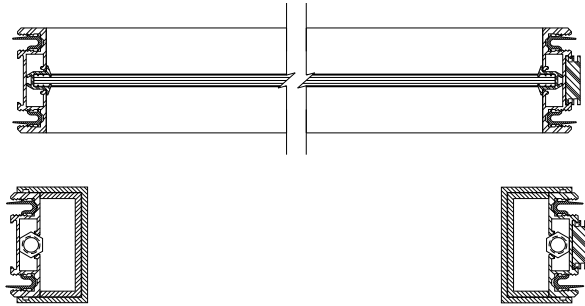

Ceiling Height		
96	8'0"	\$1178
97	8'1"	\$1178
98	8'2"	\$1178
99	8'3"	\$1178
100	8'4"	\$1178
101	8'5"	\$1178
102	8'6"	\$1178
103	8'7"	\$1178
104	8'8"	\$1178
105	8'9"	\$1178
106	8'10"	\$1178
107	8'11"	\$1178
108	9'0"	\$1178
109	9'1"	\$1253
110	9'2"	\$1253
111	9'3"	\$1253
112	9'4"	\$1253
113	9'5"	\$1253
114	9'6"	\$1253
115	9'7"	\$1253
116	9'8"	\$1253
117	9'9"	\$1253
118	9'10"	\$1253
119	9'11"	\$1253
120	10'0"	\$1253

Width		
24	24"	+\$0
30	30"	+\$35
36	36"	+\$71
39	39.5"	+\$107
42	42"	+\$107
48	48"	+\$142

Trim Finish	
B3B2B0	alum
9FA1A0	anodized
EDE9E0	base white
C0B7A8	desert storm
89989D	epoxy blue
4F4546	espresso
918D81	glimmer bronze
48494D	graphite
F3FDFD	ice white
323836	matte slate
B8AEA3	metallic stone
40403F	midnight black
201920	onyx
605746	rust bronze
636D6F	space grey
EAEBE6	stone white
A49E9E	warm grey

Base Height	
00	No Base
04	4"
06	6"

	Glass Finish				
	24"	30"	36"	39.5" & 42"	48"
GR	1/4" clear temp	+\$140	+\$175	+\$211	+\$246
GP	1/4" pattern 62	+\$192	+\$240	+\$288	+\$336
GS	1/4" laminated	+\$390	+\$488	+\$586	+\$684
GG	1/4" frosted	+\$492	+\$612	+\$734	+\$858
GL	1/4" white lam	+\$530	+\$661	+\$794	+\$926
GW	3/8" clear temp	+\$256	+\$318	+\$383	+\$445
GY	3/8" laminated	+\$553	+\$684	+\$822	+\$956
GZ	3/8" frosted	+\$677	+\$841	+\$1012	+\$1178
GI	3/8" white lam	+\$888	+\$1106	+\$1328	+\$1550
GC	1/2" clear temp	+\$371	+\$463	+\$556	+\$648
GJ	1/2" laminated	+\$744	+\$928	+\$1114	+\$1298
GU	1/2" frosted	+\$859	+\$1073	+\$1285	+\$1502
GV	1/2" white lam	+\$971	+\$1212	+\$1453	+\$1697
GX	custom or CUS				
FX	custom applied film				



# i2503 FULL HEIGHT MODULAR DOOR FRAME

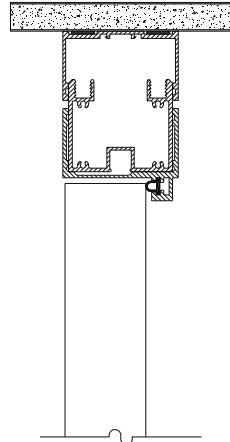
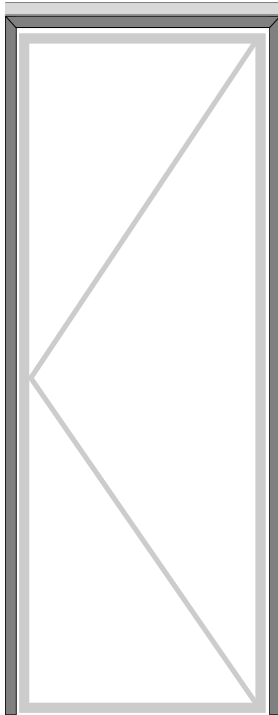

## PRODUCT INFORMATION

### Features:

- This door frame unit includes 2 metal jambs (1 strike side, 1 hinge side) and a mitered header to attach to a ceiling runner.
- Center line of strike plate is 38" ±1" from finished floor, depending on variation in floor-to-ceiling height
- Choice of left or right door swing
- Accepts standard architectural door
- Accepts 4 hinges (2 pair) and standard ASA 4 7/8" strike plate
- Comes with installation clips and screws
- On-site trimming of frames may be required. 1" excess is provided at bottom to accommodate floor-to-ceiling variations
- Vertical opening dimensions are 1/2" less than specified ceiling height. Order doors 2" shorter than specified ceiling height for proper fit
- Door, door hinges, base plug and door hardware ordered separately

### Specifiers:

- Identify ceiling height  
Use Jamb Sheet (see appendix) for ordering door frames with non-standard location of hinges as follows:  
Specify "8X" for ceiling heights from 8' to 8'11"  
Specify "9X" for ceiling heights from 9' to 9'11"  
Specify "10X" for ceiling heights 10'
- Identify frame width
- Identify left or right door swing
- Identify aluminum trim finish color
- Identify base height

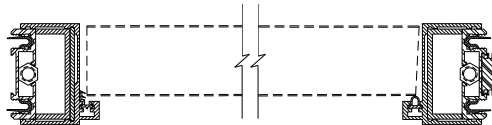

Ceiling Height		
96	8'0"	\$1432
97	8'1"	\$1432
98	8'2"	\$1432
99	8'3"	\$1432
100	8'4"	\$1432
101	8'5"	\$1432
102	8'6"	\$1432
103	8'7"	\$1432
104	8'8"	\$1432
105	8'9"	\$1432
106	8'10"	\$1432
107	8'11"	\$1432
8X	jamb sheet	\$1447
108	9'0"	\$1432
109	9'1"	\$1519
110	9'2"	\$1519
111	9'3"	\$1519
112	9'4"	\$1519
113	9'5"	\$1519
114	9'6"	\$1519
115	9'7"	\$1519
116	9'8"	\$1519
117	9'9"	\$1519
118	9'10"	\$1519
119	9'11"	\$1519
9X	jamb sheet	\$1535
120	10'0"	\$1519
10X	jamb sheet	\$1535

Width		
36	39.5"	+\$0
42	45.5"	+\$0
48	51.5"	+\$144

Door Swing	
L	left
R	right

Trim Finish	
B3B2B0	alum
9FA1A0	anodized
EDE9E0	base white
COB7A8	desert storm
89989D	epoxy blue
4F4546	espresso
918D81	glimmer bronze
48494D	graphite
F3FDFF	ice white
323836	matte slate
B8AEA3	metallic stone
40403F	midnight black
201920	onyx
605746	rust bronze
636D6F	space grey
EAEBE6	stone white
A49E9E	warm grey

Base Height	
00	No Base
04	4"
06	6"

i | 2 | 5 | 0 | 3 | . | | | |

| | |

| |

| |

| |



# i2504 FULL HEIGHT MODULAR DOUBLE DOOR FRAME

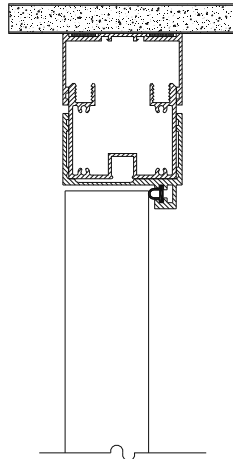
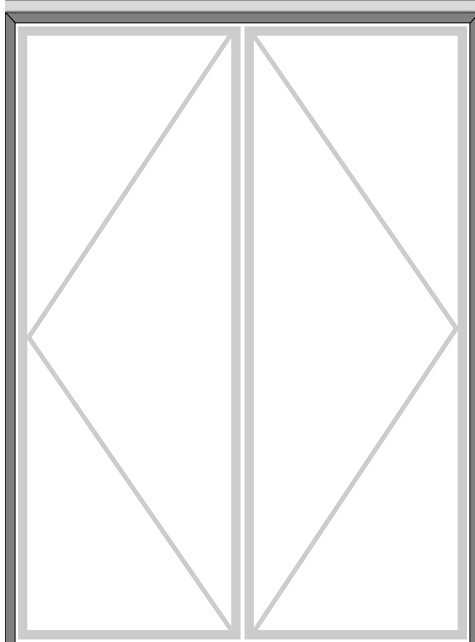

## PRODUCT INFORMATION

### Features:

- This door frame unit includes 2 metal jambs (both hinge sides) and a mitered header to attach to a ceiling runner.
- Accepts pair of swing door 36" or 42" wide
- Center line of strike plate is 38" ±1" from finished floor, depending on variation in floor-to-ceiling height
- Accepts 8 hinges (4 pair) and standard ASA 4 7/8" strike plate
- Comes with installation clips and screws
- On-site trimming of frames may be required. 1" excess is provided at bottom to accommodate floor-to-ceiling variations
- Vertical opening dimensions are 1½" less than specified ceiling height. Order doors 2" shorter than specified ceiling height for proper fit
- Door, door hinges, base plug and door hardware ordered separately

### Specifiers:

- Identify ceiling height  
Use Jamb Sheet (see appendix) for ordering door frames with non-standard location of hinges as follows:  
Specify "8X" for ceiling heights from 8' to 8'11"  
Specify "9X" for ceiling heights from 9' to 9'11"  
Specify "10X" for ceiling heights 10'
- Identify frame width  
Identify aluminum trim finish color
- Identify base height

Ceiling Height		
96	8'0"	\$1933
97	8'1"	\$1933
98	8'2"	\$1933
99	8'3"	\$1933
100	8'4"	\$1933
101	8'5"	\$1933
102	8'6"	\$1933
103	8'7"	\$1933
104	8'8"	\$1933
105	8'9"	\$1933
106	8'10"	\$1933
107	8'11"	\$1933
8X	jamb sheet	\$1949
108	9'0"	\$1933
109	9'1"	\$2051
110	9'2"	\$2051
111	9'3"	\$2051
112	9'4"	\$2051
113	9'5"	\$2051
114	9'6"	\$2051
115	9'7"	\$2051
116	9'8"	\$2051
117	9'9"	\$2051
118	9'10"	\$2051
119	9'11"	\$2051
9X	jamb sheet	\$2066
120	10'0"	\$2051
10X	jamb sheet	\$2066

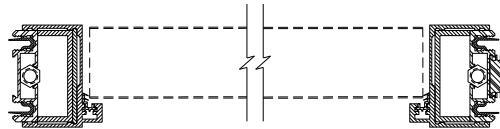

Width	
75.50	75.5"
87.50	87.5"

Trim Finish	
B3B2B0	alum
9FA1A0	anodized
EDE9E0	base white
C0B7A8	desert storm
89989D	epoxy blue
4F4546	espresso
918D81	glimmer bronze
48494D	graphite
F3FDFF	ice white
323836	matte slate
B8AEA3	metallic stone
40403F	midnight black
201920	onyx
605746	rust bronze
636D6F	space grey
EAEBE6	stone white
A49E9E	warm grey

Base Height	
00	No Base
04	4"
06	6"

i 2 5 0 4 .

.

# i2505 MODULAR DOOR FRAME WITH GLASS

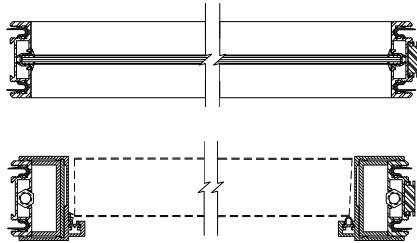
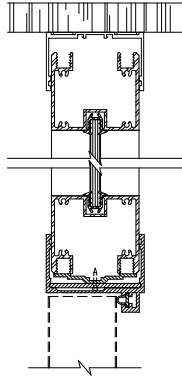
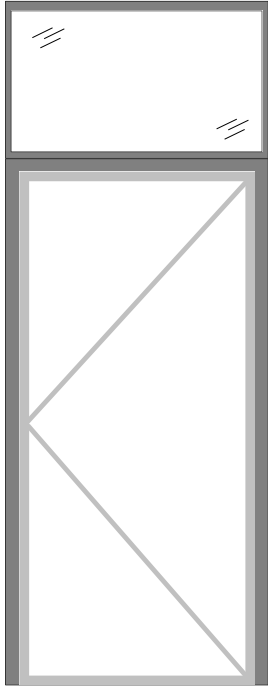

## PRODUCT INFORMATION

### Features:

- Door frame panel comes complete with clip mount to floor
- Center line of strike plate is 38" ±1" from finished floor, depending on variation in floor-to-ceiling height
- Choice of left or right door swing
- Accepts standard architectural door
- Accepts 3 hinges and standard ASA 4 7/8" strike plate
- On-site trimming of frames may be required. 1" excess is provided at bottom to accommodate floor-to-ceiling variations
- Glass transom sill height matches standard 86" sill height on wall panels
- Door, door hinges, base plug and door hardware ordered separately

### Specifiers:

- Identify ceiling height  
Use Jamb Sheet (see appendix) for ordering door frames with non-standard location of hinges as follows:  
Specify "8X" for ceiling heights from 8' to 8'11"  
Specify "9X" for ceiling heights from 9' to 9'11"  
Specify "10X" for ceiling heights 10'
- Identify frame width
- Identify left or right door swing
- Identify glass finish  
See appendix for "FX" custom applied film options
- Identify aluminum trim finish color
- Identify base height

### Ceiling Height

96	8'0"	\$2057
97	8'1"	\$2057
98	8'2"	\$2057
99	8'3"	\$2057
100	8'4"	\$2057
101	8'5"	\$2057
102	8'6"	\$2057
103	8'7"	\$2057
104	8'8"	\$2057
105	8'9"	\$2057
106	8'10"	\$2057
107	8'11"	\$2057
8X	jamb sheet	\$2311
108	9'0"	\$2057
109	9'1"	\$2089
110	9'2"	\$2089
111	9'3"	\$2089
112	9'4"	\$2089
113	9'5"	\$2089
114	9'6"	\$2089
115	9'7"	\$2089
116	9'8"	\$2089
117	9'9"	\$2089
118	9'10"	\$2089
119	9'11"	\$2089
9X	jamb sheet	\$2105
120	10'0"	\$2089
10X	jamb sheet	\$2105

### Width

36	39.5"	+\$0
42	45.5"	+\$0
48	51.5"	+\$238

### Door Swing

L	left
R	right

### Glass Finish

	39.5" & 42" Widths		48" Width
GR	1/4" clear temp	\$246	\$281
GP	1/4" pattern 62	\$336	\$383
GS	1/4" laminated	\$684	\$781
GG	1/4" frosted	\$858	\$979
GL	1/4" white lam	\$926	\$1058
GW	3/8" clear temp	+\$445	+\$510
GY	3/8" laminated	+\$956	+\$1094
GZ	3/8" frosted	+\$1178	+\$1346
GI	3/8" white lam	+\$1550	+\$1771
GC	1/2" clear temp	+\$648	+\$742
GJ	1/2" laminated	+\$1298	+\$1717
GV	1/2" white lam	+\$1697	+\$1938
GX	custom or CUS		
FX	custom applied film		

### Trim Finish

B3B2B0	alum
9FA1A0	anodized
EDE9E0	base white
C0B7A8	desert storm
89989D	epoxy blue
4F4546	espresso
918D81	glimmer bronze
48494D	graphite
F3FDFF	ice white
323836	matte slate
B8AEA3	metallic stone
40403F	midnight black
201920	onyx
605746	rust bronze
636D6F	space grey
EAEBE6	stone white
A49E9E	warm grey

### Base Height

00	No Base
04	4"
06	6"

i | 2 | 5 | 0 | 5 | . | | | | |

| | | | | | | | | |

| | | | | | | | | |

# i2506 MODULAR DOUBLE DOOR FRAME WITH GLASS

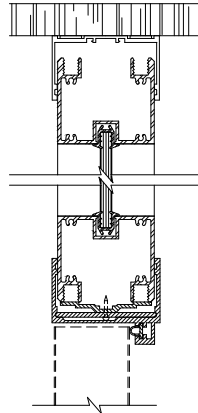
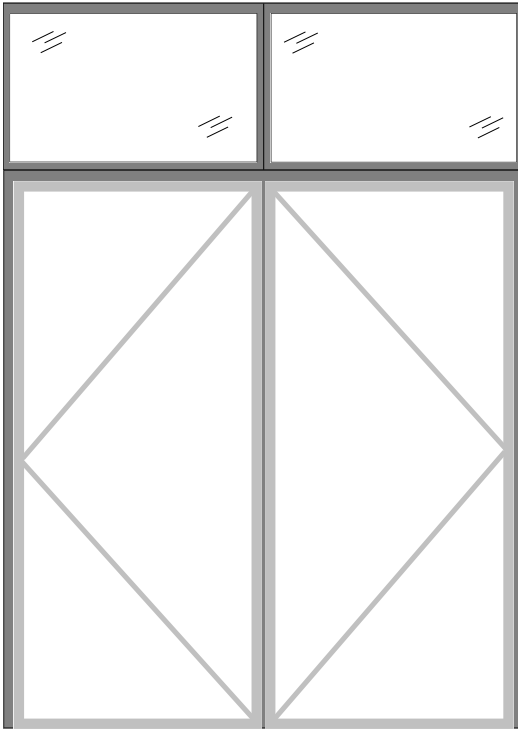

## PRODUCT INFORMATION

### Features:

- Accepts standard architectural doors
- Accepts 6 hinges (3 on each side)
- On-site trimming of frames may be required. 1" excess is provided at bottom to accommodate floor-to-ceiling variations
- Glass transom sill height matches standard 86" sill height on wall panels
- Door, door hinges, base plug and door hardware ordered separately

### Specifiers:

- Identify correct ceiling height  
Use Jamb Sheet (see appendix) for ordering door frames with non-standard location of hinges as follows:  
Specify "8X" for ceiling heights from 8' to 8'11"  
Specify "9X" for ceiling heights from 9' to 9'11"  
Specify "10X" for ceiling heights 10'
- Identify frame width
- Identify glass finish  
See appendix for "FX" custom applied film options
- Identify aluminum trim finish color
- Identify base height

Ceiling Height		
96	8'0"	\$2806
97	8'1"	\$2806
98	8'2"	\$2806
99	8'3"	\$2806
100	8'4"	\$2806
101	8'5"	\$2806
102	8'6"	\$2806
103	8'7"	\$2806
104	8'8"	\$2806
105	8'9"	\$2806
106	8'10"	\$2806
107	8'11"	\$2806
8X	jamb sheet	\$2820
108	9'0"	\$2806
109	9'1"	\$2849
110	9'2"	\$2849
111	9'3"	\$2849
112	9'4"	\$2849
113	9'5"	\$2849
114	9'6"	\$2849
115	9'7"	\$2849
116	9'8"	\$2849
117	9'9"	\$2849
118	9'10"	\$2849
119	9'11"	\$2849
9X	jamb sheet	\$2863
120	10'0"	\$2849
10X	jamb sheet	\$2863

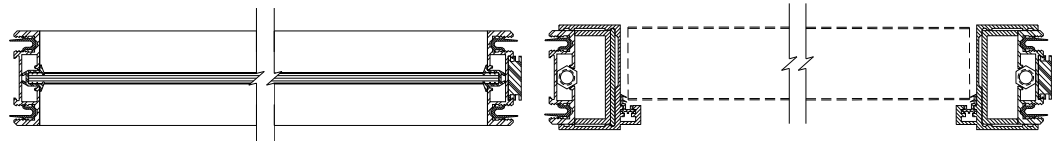

Width	
75	75.5"
87	87.5"

		Glass Finish	
		75.5" Width	87.5" Width
GR	1/4" clear temp	+\$421	+\$527
GP	1/4" pattern 62	+\$575	+\$719
GS	1/4" laminated	+\$1172	+\$1465
GG	1/4" frosted	+\$1468	+\$1835
GL	1/4" white lam	+\$1589	+\$1985
GW	3/8" clear temp	+\$763	+\$955
GY	3/8" laminated	+\$1640	+\$2051
GZ	3/8" frosted	+\$2021	+\$2527
GI	3/8" white lam	+\$2658	+\$3322
GC	1/2" clear temp	+\$1111	+\$1390
GJ	1/2" laminated	+\$2226	+\$2784
GU	1/2" frosted	+\$2575	+\$3218
GV	1/2" white lam	+\$2906	+\$3634
GX	custom or CUS		
FX	custom applied film		

Trim Finish	
B3B2B0	alum
9FA1A0	anodized
EDE9E0	base white
C0B7A8	desert storm
89989D	epoxy blue
4F4546	espresso
918D81	glimmer bronze
48494D	graphite
F3FDFF	ice white
323836	matte slate
B8AEA3	metallic stone
40403F	midnight black
201920	onyx
605746	rust bronze
636D6F	space grey
EAEBE6	stone white
A49E9E	warm grey
Base Height	
00	No Base
04	4"
06	6"

i | 2 | 5 | 0 | 6 | . | | | | |

| | |

| | |

| | | | |

# i2510 FULL HEIGHT DOOR FRAME

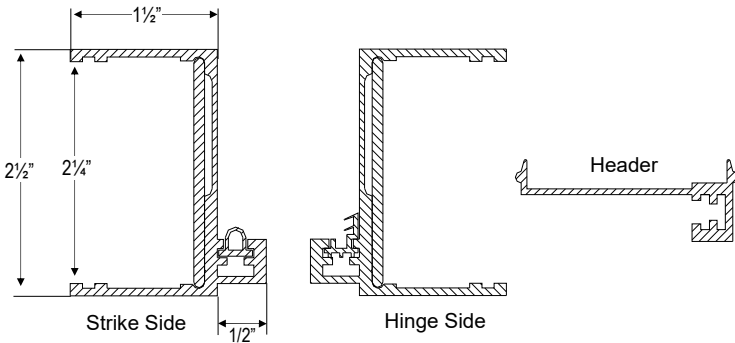
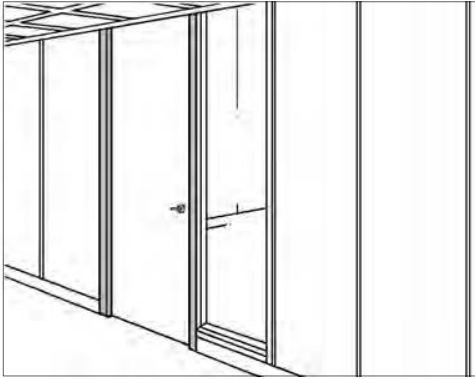

## PRODUCT INFORMATION

### Features:

- Frame includes:
  - 2 metal jambs (1 strike side and 1 hinge side)
  - Snap-in 36" header to trim the Ceiling Runner (e2110)
- Installation clips and screws are included
- Center line of strike plate is 38" ±1" from finished floor, depending on variation in floor-to-ceiling height
- Accepts 4 hinges (2 pair) and standard ASA 4 7/8" strike plate
- On-site trimming of frames may be required. 1" excess is provided at bottom to accommodate floor-to-ceiling variations
- Door, Door Hinges (i2530), and door hardware ordered separately
- Vertical opening dimensions are 1 1/2" less than specified ceiling height. Order doors 1" shorter than specified ceiling height, with cut-to-fit bottom rail, for proper fit.

### Specifiers:

- Identify ceiling height
  - Use Jamb Sheet (see appendix) for ordering door frames with non-standard location of hinges as follows:
    - Specify "8X" for ceiling heights from 8' to 8'11"
    - Specify "9X" for ceiling heights from 9' to 9'11"
    - Specify "10X" for ceiling heights 10'
- Identify left or right door swing
- Identify trim finish
- Identify plate option
  - Order "TP" option for panel interface
  - Order "FP" option for glazing or connector interface

Ceiling Height		
96	8'0"	\$550
97	8'1"	\$550
98	8'2"	\$550
99	8'3"	\$550
100	8'4"	\$550
101	8'5"	\$550
102	8'6"	\$550
103	8'7"	\$550
104	8'8"	\$550
105	8'9"	\$550
106	8'10"	\$550
107	8'11"	\$550
8X	jamb sheet	\$565
108	9'0"	\$550
109	9'1"	\$583
110	9'2"	\$583
111	9'3"	\$583
112	9'4"	\$583
113	9'5"	\$583
114	9'6"	\$583
115	9'7"	\$583
116	9'8"	\$583
117	9'9"	\$583
118	9'10"	\$583
119	9'11"	\$583
9X	jamb sheet	\$599
120	10'0"	\$583
10X	jamb sheet	\$599

Swing	
L	left
R	right

Trim Finish	
B3B2B0	alum
9FA1A0	anodized
EDE9E0	base white
C0B7A8	desert storm
89989D	epoxy blue
4F4546	espresso
918D81	glimmer bronze
48494D	graphite
F3FDFF	ice white
323836	matte slate
B8AEA3	metallic stone
40403F	midnight black
201920	onyx
605746	rust bronze
636D6F	space grey
EAEBE6	stone white
A49E9E	warm grey

Plate Option	
FP	flat plates
TP	tong plates

i 2 5 1 0 .

# i2511 FULL HEIGHT DOUBLE DOOR FRAME

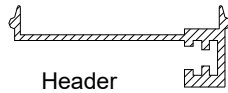
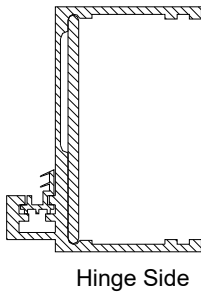
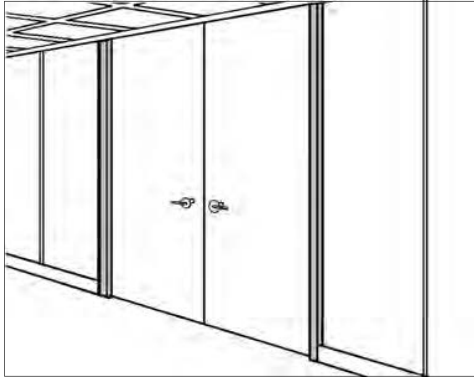

## PRODUCT INFORMATION

### Features:

- Frame includes:
  - 2 metal jambs (both hinge sides)
  - Snap-in 72" header to trim the Ceiling Runner (i2110)
- Installation clips and screws are included
- Accepts 8 hinges (4 pair)
- On-site trimming of frames may be required. 1" excess is provided at bottom to accommodate floor-to-ceiling variations
- Door, Door Hinges (i2530), and door hardware ordered separately
- Vertical opening dimensions are 1½" less than specified ceiling height. Order doors 1" shorter than specified ceiling height, with cut-to-fit bottom rail, for proper fit.

### Specifiers:

- Identify ceiling height
  - Use Jamb Sheet (see appendix) for ordering door frames with non-standard location of hinges as follows:
    - Specify "8X" for ceiling heights from 8' to 8'11"
    - Specify "9X" for ceiling heights from 9' to 9'11"
    - Specify "10X" for ceiling heights 10'
- Identify trim finish
- Identify plate option
  - Order "TP" option for panel interface
  - Order "FP" option for glazing or connector interface

Ceiling Height		
96	8'0"	\$612
97	8'1"	\$612
98	8'2"	\$612
99	8'3"	\$612
100	8'4"	\$612
101	8'5"	\$612
102	8'6"	\$612
103	8'7"	\$612
104	8'8"	\$612
105	8'9"	\$612
106	8'10"	\$612
107	8'11"	\$612
8X	jamb sheet	\$628
108	9'0"	\$612
109	9'1"	\$646
110	9'2"	\$646
111	9'3"	\$646
112	9'4"	\$646
113	9'5"	\$646
114	9'6"	\$646
115	9'7"	\$646
116	9'8"	\$646
117	9'9"	\$646
118	9'10"	\$646
119	9'11"	\$646
9X	jamb sheet	\$661
120	10'0"	\$646
10X	jamb sheet	\$661

Trim Finish	
B3B2B0	alum
9FA1A0	anodized
EDE9E0	base white
C0B7A8	desert storm
89989D	epoxy blue
4F4546	espresso
918D81	glimmer bronze
48494D	graphite
F3FDFD	ice white
323836	matte slate
B8AEA3	metallic stone
40403F	midnight black
201920	onyx
605746	rust bronze
636D6F	space grey
EAEBE6	stone white
A49E9E	warm grey

Plate Option	
FP	flat plates
TP	tong plates

i | 2 | 5 | 1 | 1 | . | | | |

| | |

| | |

# i2512 TRANSM DOOR FRAME

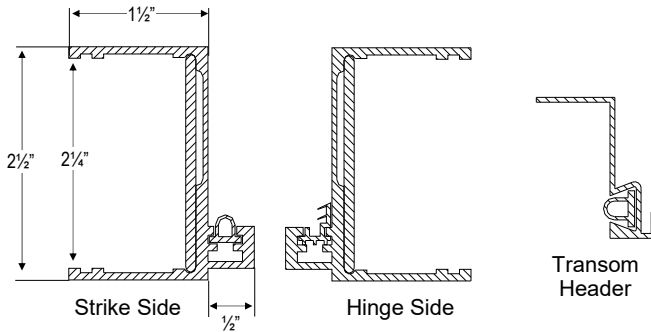
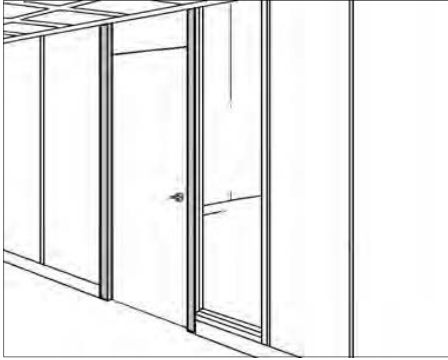

## PRODUCT INFORMATION

### Features:

- Frame includes:
  - 2 metal jambs (1 strike side and 1 hinge side)
  - 36" transom header to trim the Ceiling Runner (i2110)
- Installation clips and screws are included
- Center line of strike plate is 38" ±1" from finished floor, depending on variation in floor-to-ceiling height
- Accepts 3 hinges and standard ASA 4 7/8" strike plate
- Frame is made to fit 9' or 10' ceiling heights, but may be field cut to fit lower ceiling heights. 1" excess is provided at bottom to accommodate floor-to-ceiling variations
- Door & transom, Door Hinges (i2530), and door hardware ordered separately

### Specifiers:

- Identify ceiling height
  - Use Jamb Sheet (see appendix) for ordering door frames with non-standard location of hinges as follows:
    - Specify "8X" for ceiling heights from 8' to 8'11"
    - Specify "9X" for ceiling heights from 9' to 9'11"
    - Specify "10X" for ceiling heights 10'
- Identify left or right door swing
- Identify trim finish
- Identify plate option
  - Order "TP" option for panel interface
  - Order "FP" option for glazing or connector interface

Ceiling Height		
96	8'0"	\$529
97	8'1"	\$529
98	8'2"	\$529
99	8'3"	\$529
100	8'4"	\$529
101	8'5"	\$529
102	8'6"	\$529
103	8'7"	\$529
104	8'8"	\$529
105	8'9"	\$529
106	8'10"	\$529
107	8'11"	\$529
8X	jamb sheet	\$545
108	9'0"	\$529
109	9'1"	\$563
110	9'2"	\$563
111	9'3"	\$563
112	9'4"	\$563
113	9'5"	\$563
114	9'6"	\$563
115	9'7"	\$563
116	9'8"	\$563
117	9'9"	\$563
118	9'10"	\$563
119	9'11"	\$563
9X	jamb sheet	\$578
120	10'0"	\$619
10X	jamb sheet	\$578

Swing	
L	left
R	right

Trim Finish	
B3B2B0	alum
9FA1A0	anodized
EDE9E0	base white
C0B7A8	desert storm
89989D	epoxy blue
4F4546	espresso
918D81	glimmer bronze
48494D	graphite
F3FDFF	ice white
323836	matte slate
B8AEA3	metallic stone
40403F	midnight black
201920	onyx
605746	rust bronze
636D6F	space grey
EAEBE6	stone white
A49E9E	warm grey

Plate Option	
FP	flat plates
TP	tong plates

i	2	5	1	2	.				
---	---	---	---	---	---	--	--	--	--

--	--

--	--

--	--

# i2513 TRANSOM DOUBLE DOOR FRAME

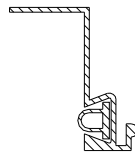
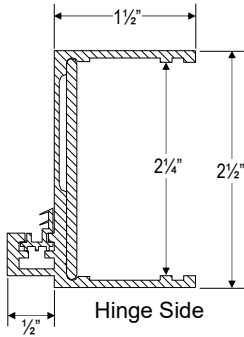
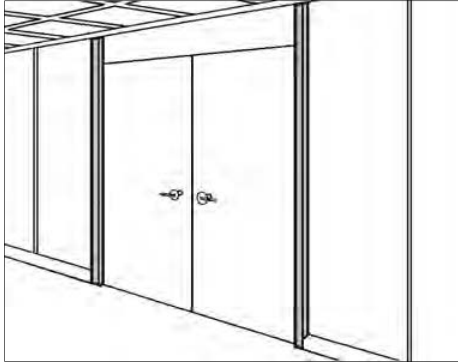

Transom Header

## PRODUCT INFORMATION

### Features:

- Frame includes:
  - 2 metal jambs (both hinge sides)
  - 72" transom header to trim the Ceiling Runner (i2110)
- Installation clips and screws are included
- Accepts 6 hinges (3 pair)
- Frame is made to fit 9' or 10' ceiling heights, but may be field cut to fit lower ceiling heights. 1" excess is provided at bottom to accommodate floor-to-ceiling variations
- Door & transom, Door Hinges (i2530), and door hardware ordered separately

### Specifiers:

- Identify ceiling height
  - Use Jamb Sheet (see appendix) for ordering door frames with non-standard location of hinges as follows:
    - Specify "8X" for ceiling heights from 8' to 8'11"
    - Specify "9X" for ceiling heights from 9' to 9'11"
    - Specify "10X" for ceiling heights 10'
- Identify trim finish
- Identify plate option
  - Order "TP" option for panel interface
  - Order "FP" option for glazing or connector interface

Ceiling Height		
96	8'0"	\$586
97	8'1"	\$586
98	8'2"	\$586
99	8'3"	\$586
100	8'4"	\$586
101	8'5"	\$586
102	8'6"	\$586
103	8'7"	\$586
104	8'8"	\$586
105	8'9"	\$586
106	8'10"	\$586
107	8'11"	\$586
8X	jamb sheet	\$602
108	9'0"	\$586
109	9'1"	\$619
110	9'2"	\$619
111	9'3"	\$619
112	9'4"	\$619
113	9'5"	\$619
114	9'6"	\$619
115	9'7"	\$619
116	9'8"	\$619
117	9'9"	\$619
118	9'10"	\$619
119	9'11"	\$619
9X	jamb sheet	\$636
120	10'0"	\$619
10X	jamb sheet	\$636

Trim Finish	
B3B2B0	alum
9FA1A0	anodized
EDE9E0	base white
C0B7A8	desert storm
89989D	epoxy blue
4F4546	espresso
918D81	glimmer bronze
48494D	graphite
F3FDFF	ice white
323836	matte slate
B8AEA3	metallic stone
40403F	midnight black
201920	onyx
605746	rust bronze
636D6F	space grey
EAEBE6	stone white
A49E9E	warm grey

Plate Option	
FP	flat plates
TP	tong plates

i | 2 | 5 | 1 | 3 | . | | |

| |

| |

# i2514 PARTIAL HEIGHT DOOR FRAME

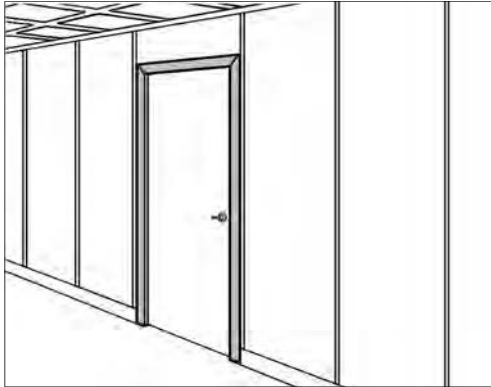

## PRODUCT INFORMATION

### Features:

- Frame includes:
  - 2 mitered metal jambs (1 strike side and 1 hinge side)
  - 36" mitered header
- Fits into an opening cut into the panel wall run
- Installation clips and screws are included
- Center line of strike plate is 38" ±1" from finished floor
- 7' - 7'9" frames accept 3 hinges, 7'10" - 10' frames accept 4 hinges (2 pair). All sizes accept standard ASA 4 7/8" strike plate
- On-site trimming of frames may be required, 1" excess is provided at bottom to accommodate floor-to-ceiling variations
- Door, Door Hinges (i2530), and door hardware ordered separately

### Specifiers:

- Identify door height
  - Use Jamb Sheet (see appendix) for ordering door frames with non-standard location of hinges as follows:
    - Specify "7X" for ceiling heights from 7' to 7'11"
    - Specify "8X" for ceiling heights from 8' to 8'11"
    - Specify "9X" for ceiling heights from 9' to 9'11"
    - Specify "10X" for ceiling heights 10'
- Identify left or right door swing
- Identify trim finish
- Identify plate option
  - Order "TP" option for panel interface
  - Order "FP" option for glazing or connector interface

Door Height		
84	7'0"	\$619
85	7'1"	\$619
86	7'2"	\$619
87	7'3"	\$619
88	7'4"	\$619
89	7'5"	\$619
90	7'6"	\$619
91	7'7"	\$619
92	7'8"	\$619
93	7'9"	\$619
94	7'10"	\$619
95	7'11"	\$619
7X	jamb sheet	\$636
96	8'0"	\$619
97	8'1"	\$619
98	8'2"	\$619
99	8'3"	\$619
100	8'4"	\$619
101	8'5"	\$619
102	8'6"	\$619
103	8'7"	\$619
104	8'8"	\$619
105	8'9"	\$619
106	8'10"	\$619
107	8'11"	\$619
8X	jamb sheet	\$636
108	9'0"	\$619
109	9'1"	\$652
110	9'2"	\$652
111	9'3"	\$652
112	9'4"	\$652
113	9'5"	\$652
114	9'6"	\$652
115	9'7"	\$652
116	9'8"	\$652
117	9'9"	\$652
118	9'10"	\$652
119	9'11"	\$652
9X	jamb sheet	\$667
120	10'0"	\$652
10X	jamb sheet	\$667

Swing	
L	left
R	right

Trim Finish	
B3B2B0	alum
9FA1A0	anodized
EDE9E0	base white
C0B7A8	desert storm
89989D	epoxy blue
4F4546	espresso
918D81	glimmer bronze
48494D	graphite
F3FDFF	ice white
323836	matte slate
B8AEA3	metallic stone
40403F	midnight black
201920	onyx
605746	rust bronze
636D6F	space grey
EAEBE6	stone white
A49E9E	warm grey

Plate Option	
FP	flat plates
TP	tong plates

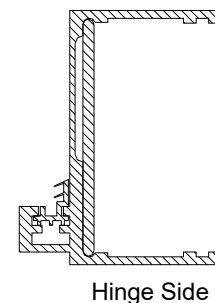
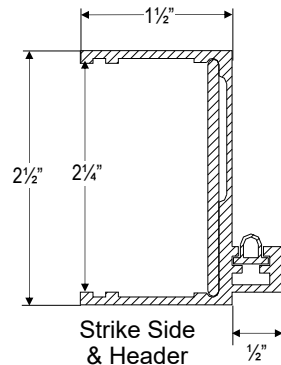

i 2 5 1 4 .



# i2515 PARTIAL HEIGHT DOUBLE DOOR FRAME

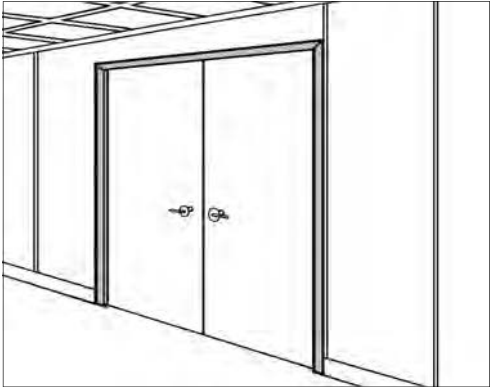

Door Height		
84	7'0"	\$719
85	7'1"	\$719
86	7'2"	\$719
87	7'3"	\$719
88	7'4"	\$719
89	7'5"	\$719
90	7'6"	\$719
91	7'7"	\$719
92	7'8"	\$719
93	7'9"	\$719
94	7'10"	\$719
95	7'11"	\$719
7X	jamb sheet	\$668
96	8'0"	\$719
97	8'1"	\$719
98	8'2"	\$719
99	8'3"	\$719
100	8'4"	\$719
101	8'5"	\$719
102	8'6"	\$719
103	8'7"	\$719
104	8'8"	\$719
105	8'9"	\$719
106	8'10"	\$719
107	8'11"	\$719
8X	jamb sheet	\$734
108	9'0"	\$719
109	9'1"	\$770
110	9'2"	\$770
111	9'3"	\$770
112	9'4"	\$770
113	9'5"	\$770
114	9'6"	\$770
115	9'7"	\$770
116	9'8"	\$770
117	9'9"	\$770
118	9'10"	\$770
119	9'11"	\$770
9X	jamb sheet	\$786
120	10'0"	\$770
10X	jamb sheet	\$786

Trim Finish	
B3B2B0	alum
9FA1A0	anodized
EDE9E0	base white
C0B7A8	desert storm
89989D	epoxy blue
4F4546	espresso
918D81	glimmer bronze
48494D	graphite
F3FDFF	ice white
323836	matte slate
B8AEA3	metallic stone
40403F	midnight black
201920	onyx
605746	rust bronze
636D6F	space grey
EAEBE6	stone white
A49E9E	warm grey

Plate Option	
FP	flat plates
TP	tong plates

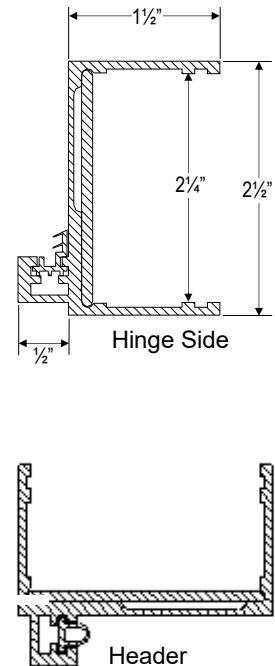

## PRODUCT INFORMATION

### Features:

- Frame includes:
  - 2 mitered metal jambs (both hinge sides)
  - 72" mitered header
- Installation clips and screws are included
- 7' - 7'9" frames accept 3 hinges, 7'10" - 10' frames accept 4 hinges (2 pair).
- On-site trimming of frames may be required, 1" excess is provided at bottom to accommodate floor-to-ceiling variations
- Door, Door Hinges (i2530), and door hardware ordered separately
- Installer must supply additional bracing at header

### Specifiers:

- Identify door height
  - Use Jamb Sheet (see appendix) for ordering door frames with non-standard location of hinges as follows:
    - Specify "7X" for ceiling heights from 7' to 7'11"
    - Specify "8X" for ceiling heights from 8' to 8'11"
    - Specify "9X" for ceiling heights from 9' to 9'11"
    - Specify "10X" for ceiling heights 10'
- Identify trim finish
- Identify plate option
  - Order "TP" option for panel interface
  - Order "FP" option for glazing or connector interface

# i2516 PARTIAL HEIGHT DOOR FRAME WITH SIDE LIGHT KIT

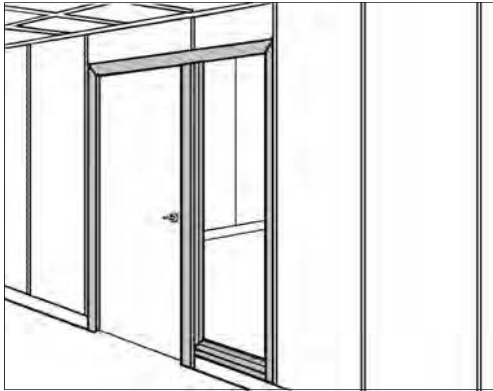

## PRODUCT INFORMATION

### Features:

- Door frame and sidelight kit includes:
  - 2 mitered metal jambs (1 strike side and 1 hinge side)
  - 60" mitered header
  - Glazing closure
  - Glazing jamb
  - Glazing sill
  - Glazing bead
- Does **not** include glass
- Installation clips and screws are included
- Center line of strike plate is 38" ±1" from finished floor
- Door frames accept 3 hinges and standard ASA 4 7/8" strike plate
- On-site trimming of frames may be required, 1" excess is provided at bottom to accommodate floor-to-ceiling variations
- Standard side light is 24 inches wide
- Side light can be field-cut to narrower width
- Door, Door Hinges (i2530), and door hardware ordered separately

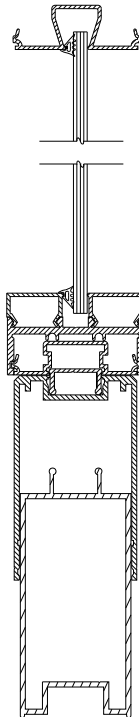
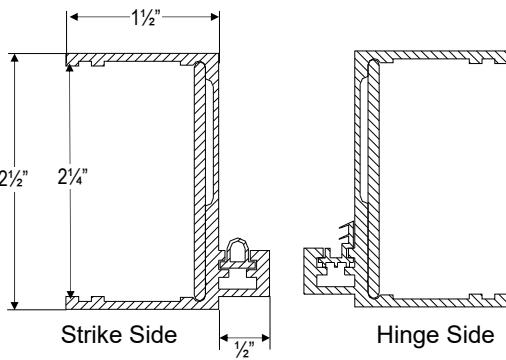

### Specifiers:

- Identify left or right door swing
- Identify trim finish
- Identify plate option
  - Order "TP" option for panel interface
  - Order "FP" option for glazing or connector interface

Door Height		
84	7'0"	\$1268

Swing	
L	left
R	right

Trim Finish	
B3B2B0	alum
9FA1A0	anodized
EDE9E0	base white
C0B7A8	desert storm
89989D	epoxy blue
4F4546	espresso
918D81	glimmer bronze
48494D	graphite
F3FDFF	ice white
323836	matte slate
B8AEA3	metallic stone
40403F	midnight black
201920	onyx
605746	rust bronze
636D6F	space grey
EAEBE6	stone white
A49E9E	warm grey

Plate Option	
FP	flat plates
TP	tong plates

i 2 5 1 6 . 8 4

# i2520 WOOD DOOR, SWINGING

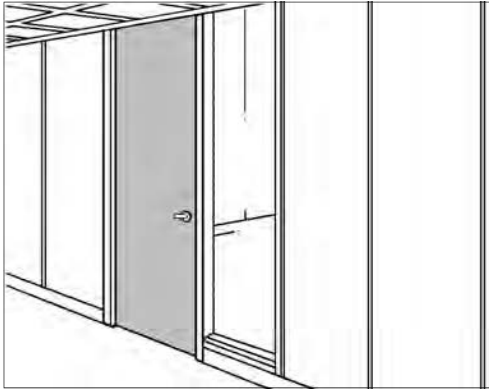

## PRODUCT INFORMATION

### Features:

- 3' wide, beveled edge, solid core door
- Standard 1/8" clearance between door and frame on each side and at the top
- On-site trimming of door may be required. A maximum of 1" may be trimmed at bottom to accommodate floor-to-ceiling variation
- 7' doors accept 3 hinges, 8' - 10' doors accept 4 hinges (2 pair)
- Hinges (i2530) and door hardware ordered separately
- Centerline of hardware preparation is 38" ± 1" from floor

**Note:** If cylindrical preparation is specified, the door will be prepared for standard cylindrical hardware, 2¾" backset. If hardware is to be field-supplied, determine compatibility with standard door prep.

### Specifiers:

- Identify door height  
Use Hinged Door Worksheet (see appendix) when specifying "7X", "8X", "9X" or "10X" for special sized and/or non-standard machined doors
- Identify left or right door swing
- Identify hardware preparation
- Identify finish
- Reference page 128 **View Window Options for Wood Doors**
- Identify crating option

Door Height		
84	7'0"	\$1438
7X	jamb sheet	\$1517
96	8'0"	\$1847
97	8'1"	\$1847
98	8'2"	\$1847
99	8'3"	\$1847
100	8'4"	\$1847
101	8'5"	\$1847
102	8'6"	\$1847
103	8'7"	\$1847
104	8'8"	\$1847
105	8'9"	\$1847
106	8'10"	\$1847
107	8'11"	\$1847
8X	door sheet	\$1926
108	9'0"	\$1847
109	9'1"	\$2002
110	9'2"	\$2002
111	9'3"	\$2002
112	9'4"	\$2002
113	9'5"	\$2002
114	9'6"	\$2002
115	9'7"	\$2002
116	9'8"	\$2002
117	9'9"	\$2002
118	9'10"	\$2002
119	9'11"	\$2002
9X	door sheet	\$2081
120	10'0"	\$2002
10X	door sheet	\$2081

Swing	
L	left
R	right

Hardware Preparation	
NA	none
CY	cylindrical prep

Finish	
DU	paint grade (unfinished) +\$0
DR	plain sliced red oak +\$799
DE	plain sliced white oak +\$799
DC	light ash laminate +\$799
DD	mahogany laminate +\$799
DA	light ash +\$1198
DM	mahogany +\$1198
DN	mahogany dark +\$1198

View Window See PAGE 128 for Option Information	
NA	none
W5	6"x27" +\$439
W6	6"x12" +\$367
W7	12"x12" +\$428
W8	24"x64" +\$1007
W9	28"x86" +\$1202

Crating	
NA	quantity is 5 or more doors
DV	quantity is 4 doors or less +\$352

i 2 5 2 0 .

S W

# VIEW WINDOW OPTIONS FOR WOOD DOORS

## OPTION INFORMATION

### Features:

- For use with Wood Door, Swinging (i 2520), Wood Door, Sliding (i 2521) and Wood Door, Swinging & Matching Transom (i 2522)
- 1/4" clear tempered glass
- Window trim matches door finish

### Specifiers:

- W5 is 6" x 27"
- W6 is 6" x 12"
- W7 is 12" x 12"
- W8 is 24" x 64"
- W9 is 24" x 86" (Available on 9' or greater door height)

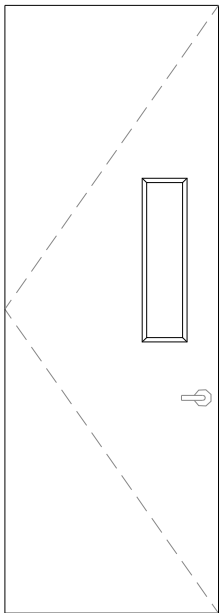

W5

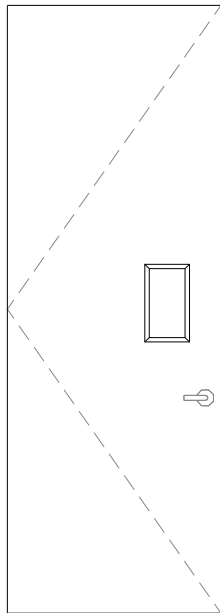

W6

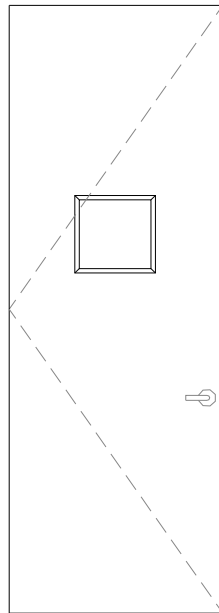

W7

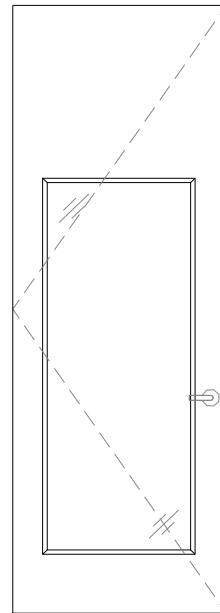

W8

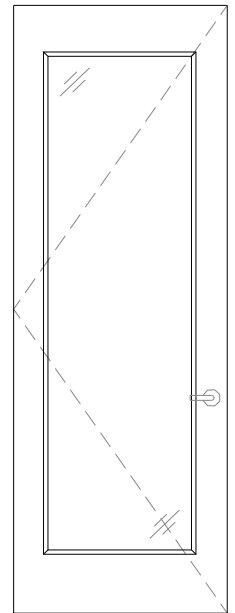

W9

# i2521 WOOD DOOR, SLIDING

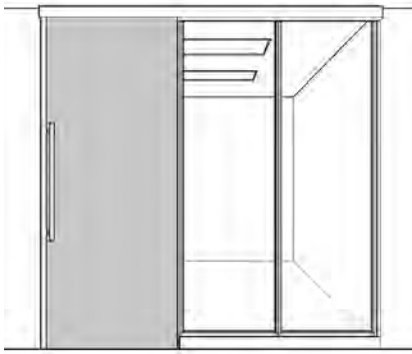

## PRODUCT INFORMATION

### Features:

- solid core door
- Attaches to Sliding Door Track & Valance (i2546)
- Lockset is equivalent to Adams Rite MS 1850S-050 ANSI/BHMI Type i8281/i8291 (grade 1)
- Receiver is for double doors that lock
- Sliding Door Track & Valance (i2546), Jamb Post (i2549) and Sliding Door Pulls (i2556) are ordered separately

### Specifiers:

- Identify door height  
Use Sliding Door Worksheet (see appendix) when specifying "7X", "8X", "9X" or "10X" for special sized and/or non-standard machined doors
- Identify door width
- Identify left or right slide direction to close
- Identify machining and lockset
- Identify finish
- Reference page 128 **View Window Options for Wood Doors**
- Identify crating option

Door Height		
84	7'0"	\$1438
7X	jamb sheet	\$1517
96	8'0"	\$1847
97	8'1"	\$1847
98	8'2"	\$1847
99	8'3"	\$1847
100	8'4"	\$1847
101	8'5"	\$1847
102	8'6"	\$1847
103	8'7"	\$1847
104	8'8"	\$1847
105	8'9"	\$1847
106	8'10"	\$1847
107	8'11"	\$1847
8X	door sheet	\$1926
108	9'0"	\$1847
109	9'1"	\$2002
110	9'2"	\$2002
111	9'3"	\$2002
112	9'4"	\$2002
113	9'5"	\$2002
114	9'6"	\$2002
115	9'7"	\$2002
116	9'8"	\$2002
117	9'9"	\$2002
118	9'10"	\$2002
119	9'11"	\$2002
9X	door sheet	\$2081
120	10'0"	\$2002
10X	door sheet	\$2081

Width		
36	36"	+\$0
37	37"	+\$479
42	42"	+\$479
48	48"	+\$479

Slide Direction to Close	
L	left
R	right

Machining / Lockset		
NA	none	\$0
M1	cup pulls & lockset	\$942
M2	cup pulls	\$80
M3	lockset	\$863
M4	receiver for dbl doors	\$96
M5	cutout	\$80
M6	cup pulls & receiver	\$175
MC	custom	\$175

Finish		
DU	paint grade (unfinished)	+\$0
DR	plain sliced red oak	+\$799
DE	plain sliced white oak	+\$799
DC	light ash laminate	+\$799
DD	mahogany laminate	+\$799
DA	light ash	+\$1198
DM	mahogany	+\$1198
DN	mahogany dark	+\$1198

View Window See Page 128 for Option Information		
NA	none	
W5	6"x27"	+\$439
W6	6"x12"	+\$367
W7	12"x12"	+\$428
W8	24"x64"	+\$1007
W9	28"x86"	+\$1202

Crating		
NA	quantity is 5 or more doors	
DV	quantity is 4 doors or less	+\$352

i | 2 | 5 | 2 | 1 | . | | | | |

S | L | | |

| | | | | | | | |

# i2522 WOOD DOOR, SWINGING & MATCHING TRANSOM

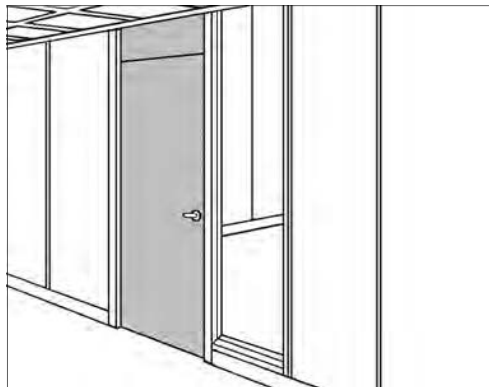

## PRODUCT INFORMATION

### Features:

- 3' x 7' solid core door with 24" or 36" high transom
- Standard 1/8" clearance between door and frame on each side
- On-site trimming of door may be required. A maximum of 1" may be trimmed at bottom to accommodate floor-to-ceiling variation
- Transom will require field-cutting for ceilings under 9' or 10'
- Door accepts 3 hinges
- Hinges (i2530) and door hardware ordered separately
- Centerline of hardware preparation is 38" ± 1" from floor
- View window or grill may be special ordered on Door Sheet (see appendix)

**Note:** If cylindrical preparation is specified, the door will be prepared for standard cylindrical hardware, 1 1/4" backset. If hardware is to be field-supplied, determine compatibility with standard door prep.

### Specifiers:

- Identify door height  
Use Hinged Door Worksheet (see appendix) when specifying "9X" or "10X" for special sized and/or non-standard machined doors
- Identify left or right door swing
- Identify hardware preparation
- Identify finish
- Reference page 128 **View Window Options for Wood Doors**
- Identify crating option

Ceiling Height			Swing		Hardware Preparation		Finish		View Window		Crating	
<b>96</b>	9'0"	\$3258	<b>L</b>	left	<b>NA</b>	none	<b>DU</b>	paint grade (unfinished)	+\$0	<b>NA</b> none		<b>NA</b> quantity is 5 or more doors
<b>9X</b>	door sheet	\$3338	<b>R</b>	right	<b>CY</b>	cylindrical prep	<b>DR</b>	plain sliced red oak	+\$799			
<b>120</b>	10'0"	\$3638					<b>DE</b>	plain sliced white oak	+\$799	<b>W5</b> 6"x27"		+\$439
							<b>DC</b>	light ash laminate	+\$799	<b>W6</b> 6"x12"		+\$367
							<b>DD</b>	mahogany laminate	+\$799	<b>W7</b> 12"x12"		+\$428
							<b>DA</b>	light ash	+\$1198	<b>W8</b> 24"x64"		+\$1007
							<b>DM</b>	mahogany	+\$1198	<b>W9</b> 28"x86"		+\$1202
							<b>DN</b>	mahogany dark	+\$1198			

i	2	5	2	2	.							
						S	W					

# i2525 ALUMINUM & GLASS DOOR, SWINGING

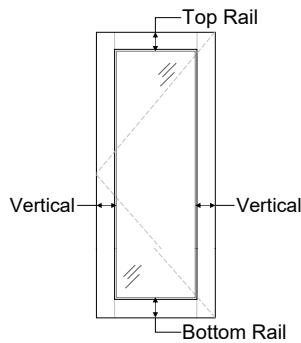
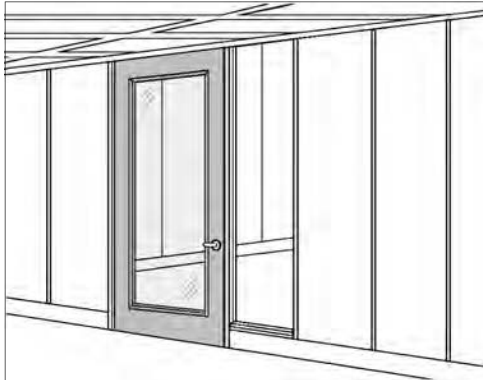

Door Height		
84	7'0"	\$2851
7X	door sheet	\$2930
96	8'0"	\$3138
97	8'1"	\$3138
98	8'2"	\$3138
99	8'3"	\$3138
100	8'4"	\$3138
101	8'5"	\$3138
102	8'6"	\$3138
103	8'7"	\$3138
104	8'8"	\$3138
105	8'9"	\$3138
106	8'10"	\$3138
107	8'11"	\$3138
8X	door sheet	\$3266
108	9'0"	\$3138
109	9'1"	\$3266
110	9'2"	\$3266
111	9'3"	\$3266
112	9'4"	\$3266
113	9'5"	\$3266
114	9'6"	\$3266
115	9'7"	\$3266
116	9'8"	\$3266
117	9'9"	\$3266
118	9'10"	\$3266
119	9'11"	\$3266
9X	door sheet	\$3346
120	10'0"	\$3266
10X	door sheet	\$3346

Frame Dimensions / Door Swing				
	Vertical	Top Rail	Bottom Rail	Swing
1L	2 5/8"	2 5/8"	2 5/8"	left
1R	2 5/8"	2 5/8"	2 5/8"	right
2L	2 5/8"	2 5/8"	4"	left
2R	2 5/8"	2 5/8"	4"	right
3L	2 5/8"	2 5/8"	6"	left
3R	2 5/8"	2 5/8"	6"	right
4L	2 5/8"	4"	4"	left
4R	2 5/8"	4"	4"	right
5L	2 5/8"	4"	6"	left
5R	2 5/8"	4"	6"	right
6L	2 5/8"	6"	6"	left
6R	2 5/8"	6"	6"	right
10L	5 1/2"	6"	6"	left
10R	5 1/2"	6"	6"	right
11L	5 1/2"	6"	10"	left
11R	5 1/2"	6"	10"	right

## PRODUCT INFORMATION

### Features:

- Aluminum-framed glass door hangs directly into standard doorframes and uses standard hinges
- Machining for hardware and 1/4" clear tempered glass is included
- Standard 1/8" clearance between door and frame on each side and at the top
- Standard 1/2" undercut clearance
- 7' doors accept 3 hinges, 8' - 10' doors accept 4 hinges (2 pair)
- Hinges (i2530) and door hardware ordered separately

**Note:** Contact Ryan Hay at rhay@mysinscape.com for special sizes or applications

### Specifiers:

- Identify door height  
Use Hinged Door Worksheet (see appendix) when specifying "7X", "8X", "9X" or "10X" for special sized and/or non-standard machined doors
- Identify left or right door swing
- Identify aluminum trim finish
- Identify glass finish  
See appendix for "FX" custom applied film options
- Identify crating option

### Trim Finish

B3B2B0	alum
9FA1A0	anodized
EDE9E0	base white
C0B7A8	desert storm
89989D	epoxy blue
4F4546	espresso
918D81	glimmer bronze
48494D	graphite
F3FDFF	ice white
323836	matte slate
B8AEA3	metallic stone
40403F	midnight black
201920	onyx
605746	rust bronze
636D6F	space grey
EAEBE6	stone white
A49E9E	warm grey

### Crating

NA	quantity is 5 or more doors
DV	quantity is 4 doors or less +\$352

### Glass Finish

	36"	37"- 42"	43"- 48"
GR	1/4" clear temp +\$211	+\$246	+\$281
GP	1/4" pattern 62 +\$288	+\$336	+\$383
GS	1/4" laminated +\$586	+\$684	+\$781
GG	1/4" frosted +\$734	+\$858	+\$979
GL	1/4" white lam +\$794	+\$926	+\$1058
GW	3/8" clear temp +\$383	+\$445	+\$510
GY	3/8" laminated +\$822	+\$956	+\$1094
GZ	3/8" frosted +\$1012	+\$1178	+\$1346
GI	3/8" white lam +\$1328	+\$1550	+\$1771
GC	1/2" clear temp +\$556	+\$648	+\$742
GJ	1/2" laminated +\$1114	+\$1298	+\$1483
GU	1/2" frosted +\$1285	+\$1502	+\$1717
GV	1/2" white lam +\$1453	+\$1697	+\$1938
GX	custom or CUS		
FX	custom applied film		

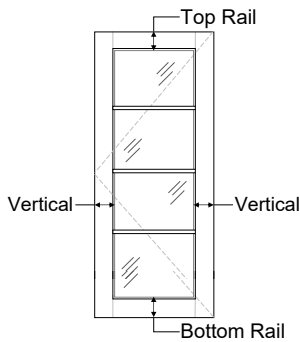
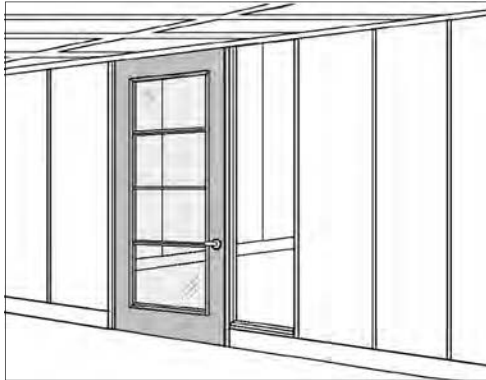

Door Height		
84	7'0"	\$2851
7X	door sheet	\$2930
96	8'0"	\$3138
97	8'1"	\$3138
98	8'2"	\$3138
99	8'3"	\$3138
100	8'4"	\$3138
101	8'5"	\$3138
102	8'6"	\$3138
103	8'7"	\$3138
104	8'8"	\$3138
105	8'9"	\$3138
106	8'10"	\$3138
107	8'11"	\$3138
8X	door sheet	\$3266
108	9'0"	\$3138
109	9'1"	\$3266
110	9'2"	\$3266
111	9'3"	\$3266
112	9'4"	\$3266
113	9'5"	\$3266
114	9'6"	\$3266
115	9'7"	\$3266
116	9'8"	\$3266
117	9'9"	\$3266
118	9'10"	\$3266
119	9'11"	\$3266
9X	door sheet	\$3346
120	10'0"	\$3266
10X	door sheet	\$3346

Frame Dimensions / Door Swing				
	Vertical	Top Rail	Bottom Rail	Swing
1L	2 5/8"	2 5/8"	2 5/8"	left
1R	2 5/8"	2 5/8"	2 5/8"	right
2L	2 5/8"	2 5/8"	4"	left
2R	2 5/8"	2 5/8"	4"	right
3L	2 5/8"	2 5/8"	6"	left
3R	2 5/8"	2 5/8"	6"	right
4L	2 5/8"	4"	4"	left
4R	2 5/8"	4"	4"	right
5L	2 5/8"	4"	6"	left
5R	2 5/8"	4"	6"	right
6L	2 5/8"	6"	6"	left
6R	2 5/8"	6"	6"	right
10L	5 1/2"	6"	6"	left
10R	5 1/2"	6"	6"	right
11L	5 1/2"	6"	10"	left
11R	5 1/2"	6"	10"	right

Horizontal Muntins		
01	1 muntin	+\$64
02	2 muntins	+\$127
03	3 muntins	+\$192
04	4 muntins	+\$256
05	5 muntins	+\$319
06	6 muntins	+\$383
07	7 muntins	+\$448
08	8 muntins	+\$511
09	9 muntins	+\$575

**PRODUCT INFORMATION**

**Features:**

- Aluminum-framed glass door hangs directly into standard doorframes and uses standard hinges
- Machining for hardware and 1/4" clear tempered glass is included
- Standard 1/8" clearance between door and frame on each side and at the top
- Standard 3/8" undercut clearance
- 7' doors accept 3 hinges, 8' - 10' doors accept 4 hinges (2 pair)
- Hinges (i 2530) and door hardware ordered separately

**Note:** Contact Ryan Hay at rhay@myinscape.com for special sizes or applications

**Specifiers:**

- Identify door height  
Use Hinged Door Worksheet (see appendix) when specifying "7X", "8X", "9X" or "10X" for special sized and/or non-standard machined doors
- Identify left or right door swing
- Identify aluminum trim finish
- Identify glass finish  
See appendix for "FX" custom applied film options
- Identify crating option

Trim Finish	
B3B2B0	alum
9FA1A0	anodized
EDE9E0	base white
C0B7A8	desert storm
89989D	epoxy blue
4F4546	espresso
918D81	glimmer bronze
48494D	graphite
F3FDFD	ice white
323836	matte slate
B8AEA3	metallic stone
40403F	midnight black
201920	onyx
605746	rust bronze
636D6F	space grey
EAEBE6	stone white
A49E9E	warm grey

Crating	
NA	quantity is 5 or more doors
DV	quantity is 4 doors or less +\$319

Glass Finish				
		36"	37"- 42"	43"- 48"
GR	1/4" clear temp	+\$211	+\$246	+\$281
GP	1/4" pattern 62	+\$288	+\$336	+\$383
GS	1/4" laminated	+\$586	+\$684	+\$781
GG	1/4" frosted	+\$734	+\$858	+\$979
GL	1/4" white lam	+\$794	+\$926	+\$1058
GW	3/8" clear temp	+\$383	+\$445	+\$510
GY	3/8" laminated	+\$822	+\$956	+\$1094
GZ	3/8" frosted	+\$1012	+\$1178	+\$1346
GI	3/8" white lam	+\$1328	+\$1550	+\$1771
GC	1/2" clear temp	+\$556	+\$648	+\$742
GJ	1/2" laminated	+\$1114	+\$1298	+\$1483
GU	1/2" frosted	+\$1285	+\$1502	+\$1717
GV	1/2" white lam	+\$1453	+\$1697	+\$1938
GX	custom or CUS			
FX	custom applied film			

i | 2 | 5 | 2 | 6 | . | | | |

| | | |

| |

| |

| |

| |



# i2530 DOOR HINGE

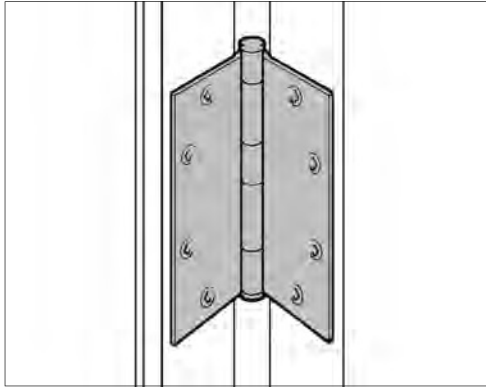

## PRODUCT INFORMATION

### Features:

- Square-cornered butt leaf design

### Specifiers:

- Identify quantity
- Identify finish

Quantity			Finish	
3	3 hinges	\$139	10A	antique bronze (US10A)
4	4 hinges	\$185	26D	satin chrome (US26D)

i 2 5 3 0 .

# i2535 ALUMINUM & GLASS DOOR, SLIDING

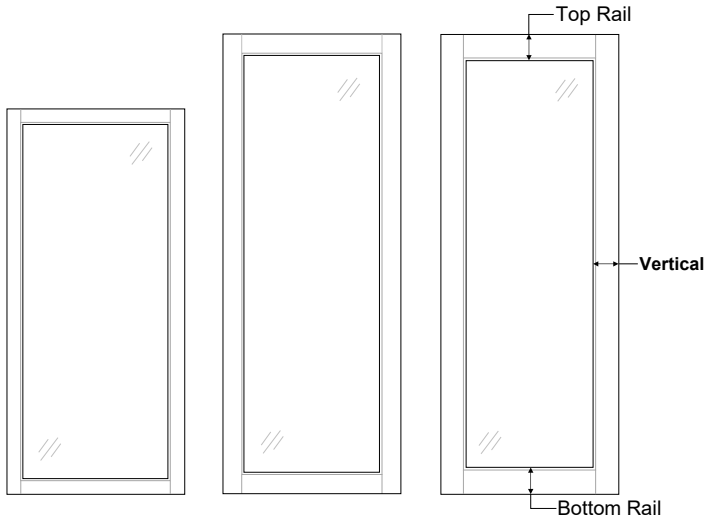

## PRODUCT INFORMATION

### Features:

- Attaches to Sliding Door Track & Valance (i2546)
- Choice of right or left action (required for glass configuration) in elevation from outside the room, direction to close.
- Lockset is 'Hook Bolt' type mortise
- Receiver is for double doors that lock
- Sliding Door Track & Valance (i2546), Sliding Door Pulls (i2556), and Sliding Door Receiver Post (i2549) are ordered separately

### Specifiers:

- Identify door height
- Identify door width
- Identify aluminum trim finish
- Identify frame dimensions & direction of close
- Identify machining and lockset  
Use Sliding Door Worksheet (see appendix) when specifying "MC"
- Identify glass finish  
See appendix for "FX" custom applied film options
- Identify crating option

Door Height		
84	7'0"	\$2396
85	7'1"	\$2396
86	7'2"	\$2396
87	7'3"	\$2396
88	7'4"	\$2396
89	7'5"	\$2396
90	7'6"	\$2396
91	7'7"	\$2396
92	7'8"	\$2396
93	7'9"	\$2396
94	7'10"	\$2396
95	7'11"	\$2396
96	8'0"	\$2664
97	8'1"	\$2664
98	8'2"	\$2664
99	8'3"	\$2664
100	8'4"	\$2664
101	8'5"	\$2664
102	8'6"	\$2664
103	8'7"	\$2664
104	8'8"	\$2664
105	8'9"	\$2664
106	8'10"	\$2664
107	8'11"	\$2664
108	9'0"	\$2544
109	9'1"	\$2544
110	9'2"	\$2544
111	9'3"	\$2544
112	9'4"	\$2544
113	9'5"	\$2544
114	9'6"	\$2544
115	9'7"	\$2544
116	9'8"	\$2544
117	9'9"	\$2544
118	9'10"	\$2544
119	9'11"	\$2544
120	10'0"	\$2544

Width		
36	36"	+\$0
37	37"	+\$96
38	38"	+\$96
39	39"	+\$96
40	40"	+\$96
41	41"	+\$96
42	42"	+\$96
43	43"	+\$127
44	44"	+\$127
45	45"	+\$127
46	46"	+\$127
47	47"	+\$127
48	48"	+\$127

Trim Finish	
B3B2B0	alum
9FA1A0	anodized
EDE9E0	base white
C0B7A8	desert storm
89989D	epoxy blue
4F4546	espresso
918D81	glimmer bronze
48494D	graphite
F3FDFF	ice white
323836	matte slate
B8AEA3	metallic stone
40403F	midnight black
201920	onyx
605746	rust bronze
636D6F	space grey
EAEBE6	stone white
A49E9E	warm grey

Machining / Lockset		
NA	none	+\$0
M1	cup pulls & lockset	+\$942
M2	cup pulls	+\$80
M3	lockset	+\$863
M4	receiver for dbl doors	+\$96
M5	cutout	+\$80
M6	cup pulls & receiver	+\$175
MC	custom	+\$175

Frame Dimensions / Slide Direction to Close				
	Vertical	Top Rail	Bottom Rail	Slide
1L	2 5/8"	2 5/8"	2 5/8"	left
1R	2 5/8"	2 5/8"	2 5/8"	right
2L	2 5/8"	2 5/8"	4"	left
2R	2 5/8"	2 5/8"	4"	right
3L	2 5/8"	2 5/8"	6"	left
3R	2 5/8"	2 5/8"	6"	right
4L	2 5/8"	4"	4"	left
4R	2 5/8"	4"	4"	right
5L	2 5/8"	4"	6"	left
5R	2 5/8"	4"	6"	right
6L	2 5/8"	6"	6"	left
6R	2 5/8"	6"	6"	right
7L	4"	4"	4"	left
7R	4"	4"	4"	right
8L	4"	4"	6"	left
8R	4"	4"	6"	right
9L	4"	6"	6"	left
9R	4"	6"	6"	right
10L	6"	6"	6"	left
10R	6"	6"	6"	right

Glass Finish				
		36"	37 - 42"	43 - 48"
GR	1/4" clear temp	+\$421	+\$492	+\$563
GP	1/4" pattern 62	+\$575	+\$671	+\$767
GS	1/4" laminated	+\$1171	+\$1366	+\$1562
GG	1/4" frosted	+\$1470	+\$1714	+\$1956
GL	1/4" white lam	+\$1589	+\$1854	+\$2118
GW	3/8" clear temp	+\$767	+\$893	+\$1018
GY	3/8" laminated	+\$1644	+\$1915	+\$2186
GZ	3/8" frosted	+\$2023	+\$2358	+\$2694
GI	3/8" white lam	+\$2658	+\$3100	+\$3544
GC	1/2" clear temp	+\$1010	+\$1297	+\$1482
GJ	1/2" laminated	+\$2225	+\$2599	+\$2969
GU	1/2" frosted	+\$2573	+\$3005	+\$3432
GV	1/2" white lam	+\$2906	+\$3392	+\$3876
GX	custom or CUS			
FX	custom applied film			

Crating	
NA	quantity is 5 or more doors
DV	quantity is 4 doors or less +\$352

i | 2 | 5 | 3 | 5 | . | | | | | | |





# i2538 FRAMELESS GLASS DOOR, SWINGING

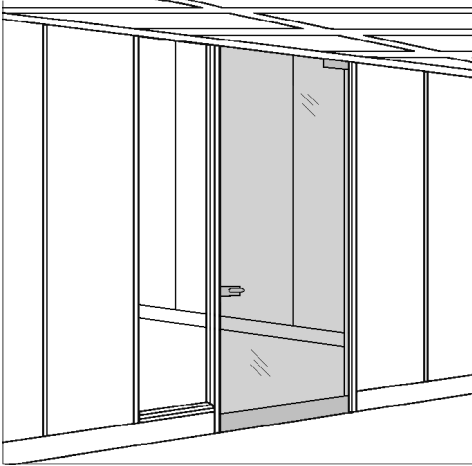

## PRODUCT INFORMATION

### Features:

- 36" standard door width includes Top Patch, 4" Bottom Rail, Header Mounted Door Stop
- Use Cased Opening (i2501), ordered separately
- Lockset or Passage Set
- 3/8" or 1/2" Glass

### Specifiers:

- Identify door height
- Identify door width
- Identify door swing
- Identify lockset/passage
- Identify glass finish  
See appendix for "FX" custom applied film options
- Identify crating option

### Door Height

84	7'0"	\$2414
85	7'1"	\$2414
86	7'2"	\$2414
87	7'3"	\$2414
88	7'4"	\$2414
89	7'5"	\$2414
90	7'6"	\$2414
91	7'7"	\$2414
92	7'8"	\$2414
93	7'9"	\$2414
94	7'10"	\$2414
95	7'11"	\$2414

96	8'0"	\$2814
97	8'1"	\$2814
98	8'2"	\$2814
99	8'3"	\$2814
100	8'4"	\$2814
101	8'5"	\$2814
102	8'6"	\$2814
103	8'7"	\$2814
104	8'8"	\$2814
105	8'9"	\$2814
106	8'10"	\$2814
107	8'11"	\$2814

108	9'0"	\$3214
109	9'1"	\$3214
110	9'2"	\$3214
111	9'3"	\$3214
112	9'4"	\$3214
113	9'5"	\$3214
114	9'6"	\$3214
115	9'7"	\$3214
116	9'8"	\$3214
117	9'9"	\$3214
118	9'10"	\$3214
119	9'11"	\$3214
120	10'0"	\$3214

### Door Width

36	36"	+\$0
42	42"	+\$145
48	48"	+\$290

### Swing

L	left
R	right

### Lock/Passage

NA	none	+\$0
M7	lockset	+\$1390
M8	passage	+\$910
MC	custom	

### Glass Finish

	36"	37"- 42"	43"- 48"
GW	3/8" clear temp	+\$1150	+\$1338
GY	3/8" laminated	+\$2466	+\$2872
GZ	3/8" frosted	+\$3035	+\$3536
GI	3/8" white lam	+\$3986	+\$4651
GC	1/2" clear temp	+\$1668	+\$1945
GJ	1/2" laminated	+\$3338	+\$3898
GU	1/2" frosted	+\$3859	+\$4507
GV	1/2" white lam	+\$4361	+\$5089
GX	custom or CUS		
FX	custom applied film		

### Crating

NA  
quantity is  
5 or more  
doors

DV  
quantity is  
4 doors or  
less +\$352

i 2 5 3 8 . [ ] [ ] [ ] [ ] [ ] S W [ ] [ ] [ ] [ ] [ ] [ ]

# i2546 SLIDING DOOR TRACK & VALANCE

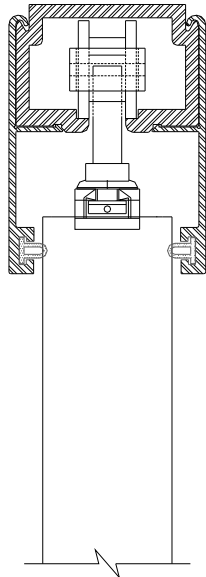

Shown with acoustic option

## PRODUCT INFORMATION

### Features:

- Aluminum track and valance supports sliding doors ( i 2535 and i 2536)
- Single or double door rollers/length.
  - Single is one pair of rollers, track = 2X unit width
  - Double is two pair of rollers, track = 4X unit width
- Partial height includes shim for mounting. Full height does not require shim
- Double (4X unit width) will have a splice joint in the centerline of front valance cover
- Acoustic Option includes vertical mount and valance seals
- Soft Open/Close Option
- Sliding Door ( i 2535 & i 2536), Sliding Door Receiver Post ( i 2549) ordered separately

### Specifiers:

- Identify height
- Identify unit width
- Identify single or double door use & acoustic option
- Identify soft closing/soft opening option
- Identify trim finish

Height		Door Unit Width			Single / Double		Soft Open/Close		Trim Finish		
<b>FH</b>	full height	<b>36</b>	36"	\$1956	<b>1S</b>	single	+\$0	<b>NA</b>	none	<b>B3B2B0</b>	alum
<b>PH</b>	partial height	<b>37</b>	37"	\$1997	<b>1A</b>	single acoustic	+\$48	<b>1C</b>	soft closer	<b>9FA1A0</b>	anodized
		<b>38</b>	38"	\$1997				<b>2C</b>	Soft open/close	<b>EDE9E0</b>	base white
		<b>39</b>	39"	\$1997	<b>2S</b>	double	+\$1118			<b>C0B7A8</b>	desert storm
		<b>40</b>	40"	\$1997	<b>2A</b>	double acoustic	+\$1214			<b>89989D</b>	epoxy blue
		<b>41</b>	41"	\$1997						<b>4F4546</b>	espresso
		<b>42</b>	42"	\$1997						<b>918D81</b>	glimmer bronze
		<b>43</b>	43"	\$2036						<b>48494D</b>	graphite
		<b>44</b>	44"	\$2036						<b>F3FDFF</b>	ice white
		<b>45</b>	45"	\$2036						<b>323836</b>	matte slate
		<b>46</b>	46"	\$2036						<b>B8AEA3</b>	metallic stone
		<b>47</b>	47"	\$2036						<b>40403F</b>	midnight black
		<b>48</b>	48"	\$2036						<b>201920</b>	onyx
										<b>605746</b>	rust bronze
										<b>636D6F</b>	space grey
										<b>EAEBE6</b>	stone white
										<b>A49E9E</b>	warm grey



**PRODUCT INFORMATION**

**Features:**

- Attaches to cased opening which is ordered separately
- Includes installation clips
- Ships as a 2 piece kit
- Sliding Door (i2535 & i2536), Sliding Door Track & Valance (i2546) ordered separately

**Specifiers:**

- Identify door height
- Identify machining option
- Identify trim finish

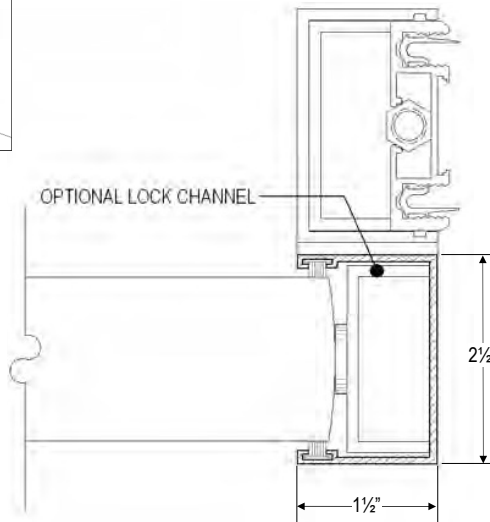

Door Height		
84	7'0"	\$486
85	7'1"	\$486
86	7'2"	\$486
87	7'3"	\$486
88	7'4"	\$486
89	7'5"	\$486
90	7'6"	\$486
91	7'7"	\$486
92	7'8"	\$486
93	7'9"	\$486
94	7'10"	\$486
95	7'11"	\$486
96	8'0"	\$486
97	8'1"	\$486
98	8'2"	\$486
99	8'3"	\$486
100	8'4"	\$486
101	8'5"	\$486
102	8'6"	\$486
103	8'7"	\$486
104	8'8"	\$486
105	8'9"	\$486
106	8'10"	\$486
107	8'11"	\$486
108	9'0"	\$486
109	9'1"	\$521
110	9'2"	\$521
111	9'3"	\$521
112	9'4"	\$521
113	9'5"	\$521
114	9'6"	\$521
115	9'7"	\$521
116	9'8"	\$521
117	9'9"	\$521
118	9'10"	\$521
119	9'11"	\$521
120	10'0"	\$521

Machining		
NA	none	
M9	lock channel	\$240

Trim Finish	
B3B2B0	alum
9FA1A0	anodized
EDE9E0	base white
C0B7A8	desert storm
89989D	epoxy blue
4F4546	espresso
918D81	glimmer bronze
48494D	graphite
F3FDFD	ice white
323836	matte slate
B8AEA3	metallic stone
40403F	midnight black
201920	onyx
605746	rust bronze
636D6F	space grey
EAEBE6	stone white
A49E9E	warm grey

i 2 5 4 9 . | | |

| | |

| |

# i2540 DOORSTOP

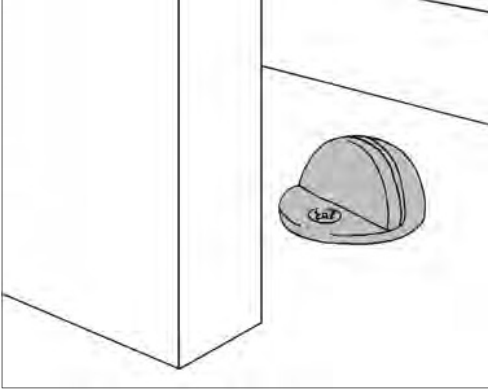

## PRODUCT INFORMATION

### Features:

- Floor-mounted stop is installed behind doors at the full open position to prevent damage to adjacent surfaces

### Specifiers:

- Identify finish

Product Number		Finish	
i2540	\$30	10A	bronze (US10A)
		26D	satin chrome (US26D)

i | 2 | 5 | 4 | 0 |

↓  
| | |



# V2545 COAT HOOK

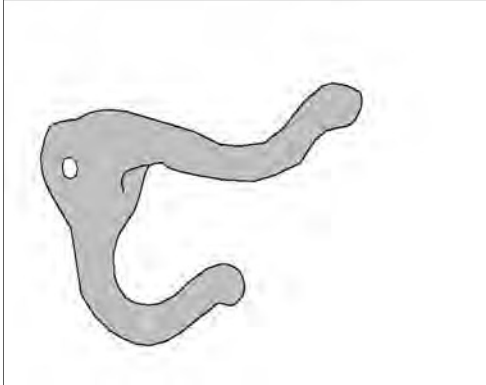

## PRODUCT INFORMATION

### Features:

- Heavy duty cast unit
- Attaches into door
- Attachment hardware included

### Specifiers:

- Identify finish

Product Number	Finish
i2545 \$54	10A antique bronze (US10A) 26D satin chrome (US26D)

i | 2 | 5 | 4 | 5

| | | |

# i2550 DOOR LEVER

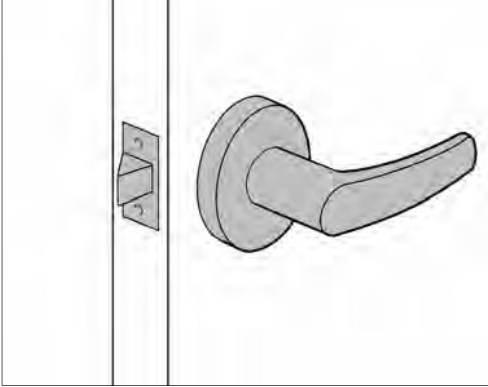

## PRODUCT INFORMATION

### Features:

- Door lever with lock or passage function
- Similar to Yale 5407L or Cal-Royal Genesys levers

### Specifiers:

- Identify function
- Identify lock face
- Identify finish

Product Number	Function	Lock Face	Finish
i2550.L     \$608	<b>N</b> passage <b>W</b> lockset    +\$420	<b>S</b> standard <b>R</b> reverse	<b>10A</b> antique bronze (US10A) <b>26D</b> satin chrome (US26D)

i | 2 | 5 | 5 | 0 | . | L

□

□

□ □ □ □

# i2551 CONSTRUCTION CORE LOCKSET

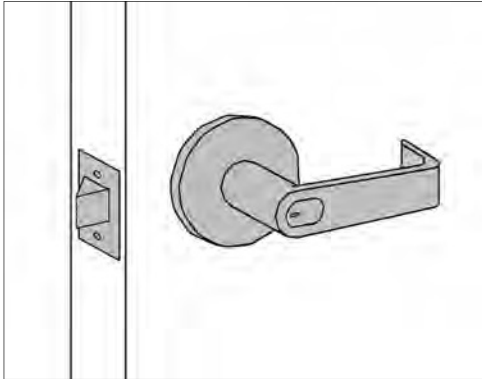

## PRODUCT INFORMATION

### Features:

- Lever lockset comes with replaceable keyed core
- Construction core is replaced by the facility management
- Similar to Best Lockset 7K or Cal-Royal Genesys levers
- Includes turn button lock

### Specifiers:

- Identify bevel face
  - When door swings away from keyed side, specify "S"
  - When door swings toward keyed side, specify "R"
- Identify finish

Product Number	Bevel Face	Finish
i2551.MW \$1028	S standard R reverse	10A antique bronze (US10A) 26D satin chrome (US26D)

i | 2 | 5 | 5 | 1 | . | M | W

□

□ □ □

# i2552 COMBINATION LOCKSET

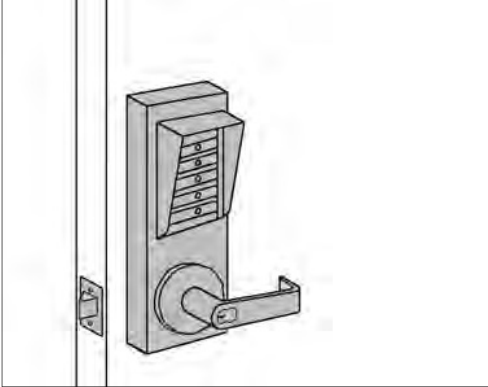

## PRODUCT INFORMATION

### Features:

- Lever lockset includes 5 pushbutton access
- Mounts into standard doors with standard preparation
- Equivalent to Simplex L1000 model
- Includes replaceable core and turn button lock

### Specifiers:

- Identify bevel face
  - When door swings away from keyed side, specify "S"
  - When door swings toward keyed side, specify "R"
- Identify finish

**Product Number**  
 i2552.MW \$3802

**Bevel Face**  
 S standard  
 R reverse

**Finish**  
 10A antique bronze (US10A)  
 26D satin chrome (US26D)

i | 2 | 5 | 5 | 2 | . | M | W

□

□ □ □

# i2553 DUMMY DOOR LEVER

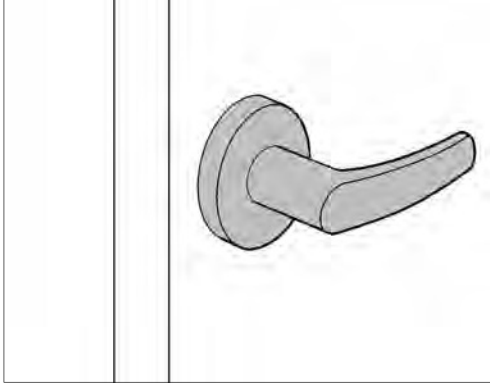

## PRODUCT INFORMATION

### Features:

- Dummy lever for swing style double door sets
- Attaches to inactive door to match hardware on active door
- Equivalent to Schlage AL170 Jupiter style

### Specifiers:

- Identify finish

Product Number	Finish
i2553      \$448	<b>10A</b> antique bronze (US10A) <b>26D</b> satin chrome (US26D)

i | 2 | 5 | 5 | 3 | . | | | |

**i2556 SLIDING DOOR PULLS**



P1



P2



P3 & P5

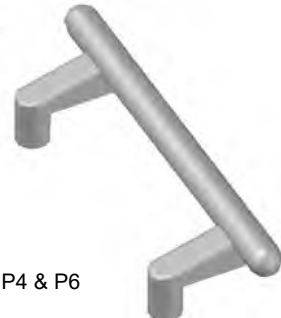

P4 & P6

**PRODUCT INFORMATION**

**Features:**

- Solid stainless steel or bronze bar pulls
- Matching pair
- Use in Sliding Doors i2535 or i2536
- Includes attachment screws
- Does not interfere with Sliding Door Receiver Post i2549

**Specifiers:**

- Identify style / length
- Identify finish

**Style / Length**

<b>P1</b>	straight 10" D pulls	\$304
<b>P2</b>	offset 10" D pulls	\$763
<b>P3</b>	straight 13" post pulls	\$1174
<b>P4</b>	offset 13" post pulls	\$1429
<b>P5</b>	straight 48" post pulls	\$1558
<b>P6</b>	offset 48" post pulls	\$1813

**Finish**

<b>10A</b>	antique bronze (US10A)
<b>26D</b>	satin chrome (US26D)

i 2 5 5 6 .

# i2570 MODULAR 42" FULL HEIGHT DOOR FRAME WITH CHASE

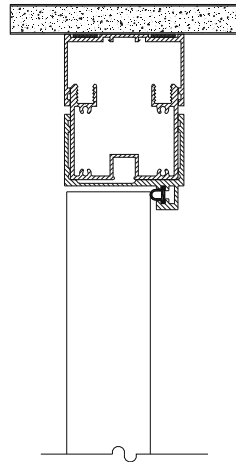
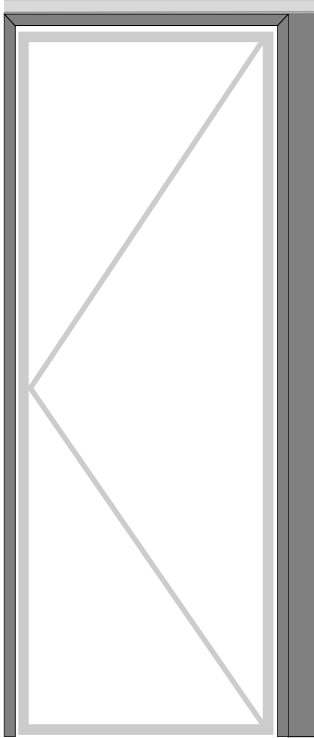

## PRODUCT INFORMATION

### Features:

- This door frame unit includes 2 metal jambs (1 strike side, 1 hinge side) and a mitered header to attach to a ceiling runner.
- Includes open aluminum chase for relocatable switch or cabling
- Center line of strike plate is 38" ±1" from finished floor, depending on variation in floor-to-ceiling height
- Choice of left or right door swing
- Choice of electrical switch assembly (located on inside)
- Accepts standard architectural 36" wide door
- Accepts 4 hinges (2 pair) and standard ASA 4 7/8" strike plate
- Comes with installation clips and screws
- On-site trimming of frames may be required. 1" excess is provided at bottom to accommodate floor-to-ceiling variations

### Specifiers:

- Identify ceiling height - see PIN  
Vertical opening dimensions are 1/2" less than specified ceiling height. Order doors 2" shorter than specified ceiling height for proper fit
- Use Jamb Sheet (see appendix) for non-standard location of strike plate or hinges  
Specify "8X" for ceiling heights from 8' to 8'11"  
Specify "9X" for ceiling heights from 9' to 9'11"  
Specify "10X" for ceiling heights 10'
- Identify left or right door swing
- Identify electrical option
- Identify aluminum trim finish color
- Door, door hinges and door hardware ordered separately

Ceiling Height		
96	8'0"	\$1760
97	8'1"	\$1760
98	8'2"	\$1760
99	8'3"	\$1760
100	8'4"	\$1760
101	8'5"	\$1760
102	8'6"	\$1760
103	8'7"	\$1760
104	8'8"	\$1760
105	8'9"	\$1760
106	8'10"	\$1760
107	8'11"	\$1760
8X	jamb sheet	\$1776
108	9'0"	\$1760
109	9'1"	\$1859
110	9'2"	\$1859
111	9'3"	\$1859
112	9'4"	\$1859
113	9'5"	\$1859
114	9'6"	\$1859
115	9'7"	\$1859
116	9'8"	\$1859
117	9'9"	\$1859
118	9'10"	\$1859
119	9'11"	\$1859
9X	jamb sheet	\$1876
120	10'0"	\$1859
10X	jamb sheet	\$1876

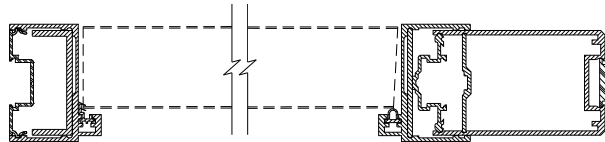

Width	
42	42"

Door Swing	
L	left
R	right

Electrical Option		
NA	none	+\$0
E4	switch assembly, 120v	+\$388
E5	switch assembly, 277v	+\$388

Trim Finish	
B3B2B0	alum
9FA1A0	anodized
EDE9E0	base white
C0B7A8	desert storm
89989D	epoxy blue
4F4546	espresso
918D81	glimmer bronze
48494D	graphite
F3FDFF	ice white
323836	matte slate
B8AEA3	metallic stone
40403F	midnight black
201920	onyx
605746	rust bronze
636D6F	space grey
EAEBE6	stone white
A49E9E	warm grey

Base Height	
00	No Base
04	4"
06	6"

i | 2 | 5 | 7 | 0 | . | | |

4 | 2 | | |

| | |

| | |

| | | | |

**i2571 MODULAR 42" TRANSOM DOOR FRAME WITH CHASE**

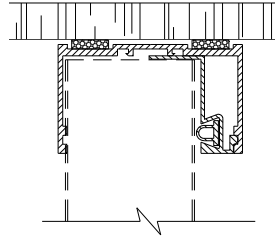
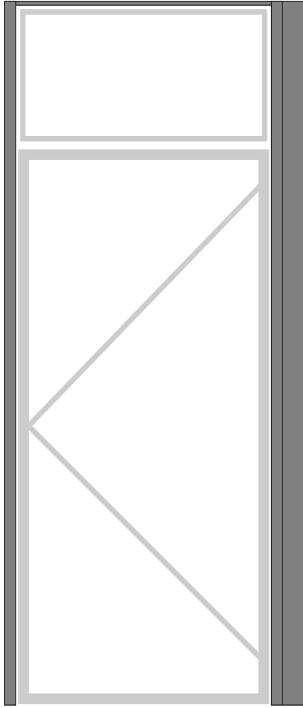

**PRODUCT INFORMATION**

**Features:**

- This door frame kit Includes 2 metal jambs (1 strike side, 1 hinge side) and a 36" transom header at the ceiling runner.
- Open aluminum chase for relocatable switch or cabling
- Center line of strike plate is 38" ±1" from finished floor, depending on variation in floor-to-ceiling height
- Choice of left or right door swing
- Choice of electrical switch assembly (located on inside)
- Accepts standard architectural 3'0" x 7'0" door
- Accepts 3 hinges and standard ASA 4 7/8" strike plate
- Comes with installation clips and screws
- On-site trimming of frames may be required. 1" excess is provided at bottom to accommodate floor-to-ceiling variations

**Specifiers:**

- Identify correct ceiling height - see PIN
- Use Jamb Sheet (see appendix) for non-standard location of strike plate or hinges
  - Specify "8X" for ceiling heights from 8' to 8'11"
  - Specify "9X" for ceiling heights from 9' to 9'11"
  - Specify "10X" for ceiling heights 10'
- Identify left or right door swing
- Identify electrical option
- Identify aluminum trim finish color
- Door, transom, door hinges and door hardware ordered separately

Ceiling Height		
96	8'0"	\$1768
97	8'1"	\$1768
98	8'2"	\$1768
99	8'3"	\$1768
100	8'4"	\$1768
101	8'5"	\$1768
102	8'6"	\$1768
103	8'7"	\$1768
104	8'8"	\$1768
105	8'9"	\$1768
106	8'10"	\$1768
107	8'11"	\$1768
8X	jamb sheet	\$1784
108	9'0"	\$1768
109	9'1"	\$1867
110	9'2"	\$1867
111	9'3"	\$1867
112	9'4"	\$1867
113	9'5"	\$1867
114	9'6"	\$1867
115	9'7"	\$1867
116	9'8"	\$1867
117	9'9"	\$1867
118	9'10"	\$1867
119	9'11"	\$1867
9X	jamb sheet	\$1883
120	10'0"	\$1867
10X	jamb sheet	\$1883

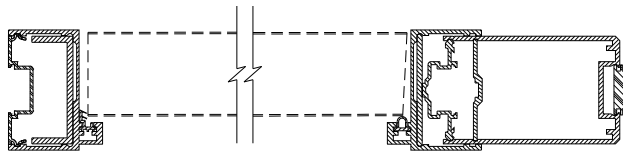

Width		Door Swing		Electrical Option		
42	42"	L	left	NA	none	+\$0
		R	right	E4	switch assembly, 120v	+\$388
				E5	switch assembly, 277v	+\$388

Trim Finish	
B3B2B0	alum
9FA1A0	anodized
EDE9E0	base white
C0B7A8	desert storm
89989D	epoxy blue
4F4546	espresso
918D81	glimmer bronze
48494D	graphite
F3FDFD	ice white
323836	matte slate
B8AEA3	metallic stone
40403F	midnight black
201920	onyx
605746	rust bronze
636D6F	space grey
EAEBE6	stone white
A49E9E	warm grey

Base Height	
00	No Base
04	4"
06	6"

i | 2 | 5 | 7 | 1 | . | | |

4 | 2 |

|

| |

| |

| |



# i2572 MODULAR 39.5" DOOR FRAME PANEL WITH HARD SURFACE

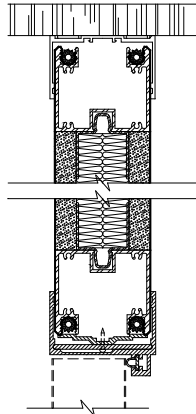
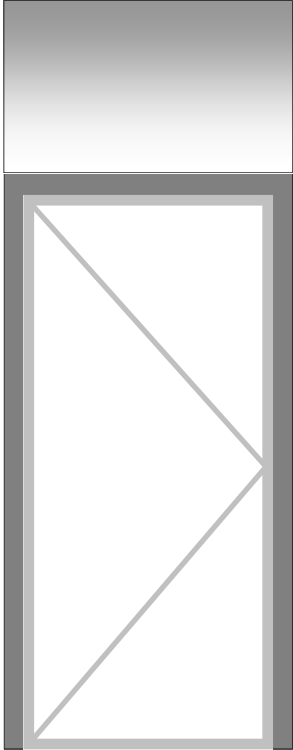

## PRODUCT INFORMATION

### Features:

- Door frame panel comes complete with clip mount to floor
- Center line of strike plate is 38" ±1" from finished floor, depending on variation in floor-to-ceiling height
- Choice of left or right door swing
- Accepts standard architectural 3'0" x 7'0" door
- Accepts 3 hinges and standard ASA 4 7/8" strike plate
- On-site trimming of frames may be required. 1" excess is provided at bottom to accommodate floor-to-ceiling variations

### Specifiers:

- Identify correct ceiling height - see PIN
- Use Jamb Sheet (see appendix) for non-standard location of strike plate or hinges
  - Specify "8X" for ceiling heights from 8' to 8'11"
  - Specify "9X" for ceiling heights from 9' to 9'11"
  - Specify "10X" for ceiling heights 10'
- Identify left or right door swing
- Identify aluminum trim finish color
- Identify hard surface finish for each side separately
  - For "CUS" customer must provide 1 linear yard per side
  - See appendix for vinyl styles and colors
- Door, door hinges and door hardware ordered separately

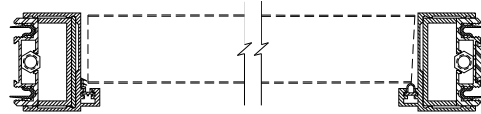
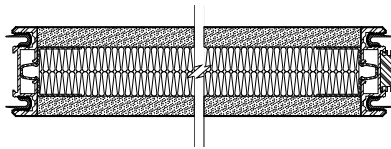

### Ceiling Height

96	8'0"	\$2303
97	8'1"	\$2303
98	8'2"	\$2303
99	8'3"	\$2303
100	8'4"	\$2303
101	8'5"	\$2303
102	8'6"	\$2303
103	8'7"	\$2303
104	8'8"	\$2303
105	8'9"	\$2303
106	8'10"	\$2303
107	8'11"	\$2303
8X	jamb sheet	\$2320
108	9'0"	\$2303
109	9'1"	\$2341
110	9'2"	\$2341
111	9'3"	\$2341
112	9'4"	\$2341
113	9'5"	\$2341
114	9'6"	\$2341
115	9'7"	\$2341
116	9'8"	\$2341
117	9'9"	\$2341
118	9'10"	\$2341
119	9'11"	\$2341
9X	jamb sheet	\$2358
120	10'0"	\$2341
10X	jamb sheet	\$2358

**Width**  
39 39.5"

**Door Swing**  
L left  
R right

### Trim Finish

B3B2B0	alum
9FA1A0	anodized
EDE9E0	base white
C0B7A8	desert storm
89989D	epoxy blue
4F4546	espresso
918D81	glimmer bronze
48494D	graphite
F3FDFF	ice white
323836	matte slate
B8AEA3	metallic stone
40403F	midnight black
201920	onyx
605746	rust bronze
636D6F	space grey
EAEBE6	stone white
A49E9E	warm grey

### Base Height

00	No Base
04	4"
06	6"

### Surface Finish Side 1 / Side 2

First 2 digits specify series,  
last 2 specify color

CUS	customer material	+\$4
AD __	adobe	+\$25
----	category 1	+\$61
----	category 2	+\$67
----	category 3	+\$77
----	category 4	+\$100
----	category 5	+\$137
----	category 6	+\$202
----	category 7	+\$259

i 2 5 7 2 .

3 9

# i2573 MODULAR 48" DOOR FRAME PANEL WITH GLASS

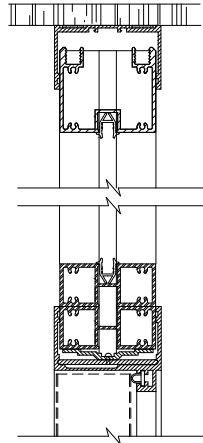
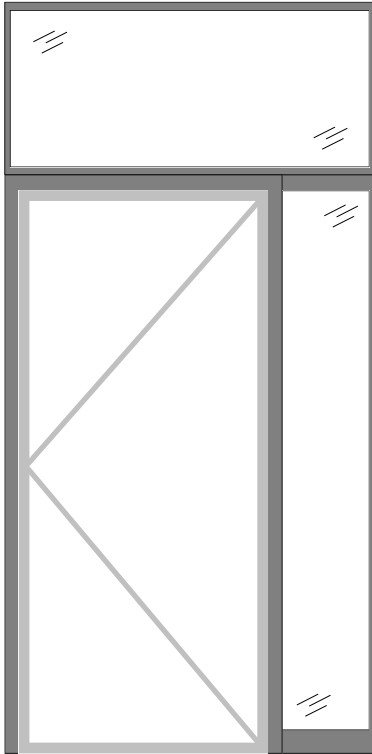

## PRODUCT INFORMATION

### Features:

- Door frame panel comes complete with clip mount to floor
- Center line of strike plate is 38" ±1" from finished floor, depending on variation in floor-to-ceiling height
- Choice of left or right door swing
- Accepts standard architectural 3'0" x 7'0" door
- Accepts 3 hinges and standard ASA 4 7/8" strike plate
- On-site trimming of frames may be required. 1" excess is provided at bottom to accommodate floor-to-ceiling variations
- Transom sill height matches standard 86" sill height on wall panels

### Specifiers:

- Identify correct ceiling height
  - Specify "8X" for ceiling heights from 8' to 8'11"
  - Specify "9X" for ceiling heights from 9' to 9'11"
  - Specify "10X" for ceiling heights 10'
- Identify left or right door swing
- Identify side lite glass finish
  - See appendix for "FX" custom applied film options
- Identify transom finish (Insert/Outsert sold separately)
- Identify aluminum trim finish color
- Identify base height
- Door, door hinges and door hardware ordered separately

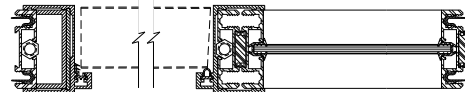
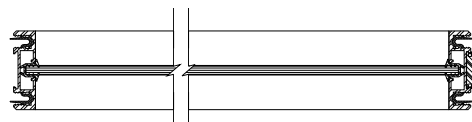

Ceiling Height		
96	8'0"	\$2978
97	8'1"	\$2978
98	8'2"	\$2978
99	8'3"	\$2978
100	8'4"	\$2978
101	8'5"	\$2978
102	8'6"	\$2978
103	8'7"	\$2978
104	8'8"	\$2978
105	8'9"	\$2978
106	8'10"	\$2978
107	8'11"	\$2978
8X	jamb sheet	\$2995
108	9'0"	\$2978
109	9'1"	\$3040
110	9'2"	\$3040
111	9'3"	\$3040
112	9'4"	\$3040
113	9'5"	\$3040
114	9'6"	\$3040
115	9'7"	\$3040
116	9'8"	\$3040
117	9'9"	\$3040
118	9'10"	\$3040
119	9'11"	\$3040
9X	jamb sheet	\$3055
120	10'0"	\$3040
10X	jamb sheet	\$3055

Width	
48	48"

Door Swing	
L	left
R	right

Side Lite Glass Finish		
GR	1/4" clear temp	+\$563
GP	1/4" pattern 62	+\$766
GS	1/4" laminated	+\$1561
GG	1/4" frosted	+\$1956
GL	1/4" white lam	+\$2117
GW	3/8" clear temp	+\$1016
GY	3/8" laminated	+\$2186
GZ	3/8" frosted	+\$2694
GI	3/8" white lam	+\$3545
GC	1/2" clear temp	+\$1482
GJ	1/2" laminated	+\$2969
GU	1/2" frosted	+\$3432
GV	1/2" white lam	+\$3876
GX	custom or CUS	
FX	custom applied film	

Transom Finish		
GR	1/4" clear temp	+281
GP	1/4" pattern 62	+\$383
GS	1/4" laminated	+\$781
GG	1/4" frosted	+\$979
GL	1/4" white lam	+\$1058
GW	3/8" clear temp	+\$510
GY	3/8" laminated	+\$1094
GZ	3/8" frosted	+\$1346
GI	3/8" white lam	+\$1771
GC	1/2" clear temp	+\$740
GJ	1/2" laminated	+\$1483
GU	1/2" frosted	+\$1717
GV	1/2" white lam	+\$1938
GX	custom or CUS	
FX	custom applied film	
IN	Insert (Outsert)	Sold Separately

Trim Finish	
B3B2B0	alum
9FA1A0	anodized
EDE9E0	base white
C0B7A8	desert storm
89989D	epoxy blue
4F4546	espresso
918D81	glimmer bronze
48494D	graphite
F3FDFF	ice white
323836	matte slate
B8AE3	metallic stone
40403F	midnight black
201920	onyx
605746	rust bronze
636D6F	space grey
EAEBE6	stone white
A49E9E	warm grey

Base Height	
00	No Base
04	4"
06	6"

i | 2 5 7 3 . | | |

4 8 | | |

| | |

| | | | |

# i2574 MODULAR 48" DOOR FRAME PANEL WITH MULTI-LITE

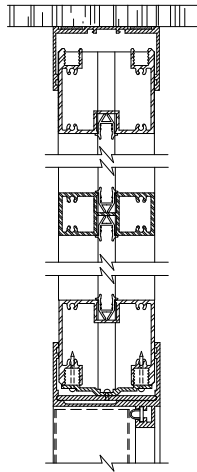
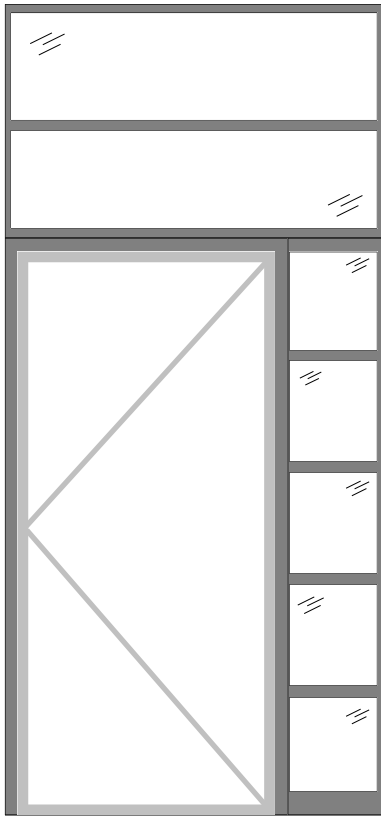

## PRODUCT INFORMATION

### Features:

- Door frame panel comes complete with clip mount to floor
- Center line of strike plate is 38" ±1" from finished floor, depending on variation in floor-to-ceiling height
- Choice of left or right door swing
- Accepts standard architectural 3'0" x 7'0" door
- Accepts 3 hinges and standard ASA 4 7/8" strike plate
- On-site trimming of frames may be required. 1" excess is provided at bottom to accommodate floor-to-ceiling variations
- Transom sill height matches standard 86" sill height on wall panels

### Specifiers:

- Identify correct ceiling height
  - Specify "8X" for ceiling heights from 8' to 8'11"
  - Specify "9X" for ceiling heights from 9' to 9'11"
  - Specify "10X" for ceiling heights 10'
- Identify left or right door swing
- Identify side lite glass finish
  - See appendix for "FX" custom applied film options
- Identify transom finish (Insert/Outsert sold separately)
- Identify aluminum trim finish color
- Identify base height
- Door, door hinges and door hardware ordered separately

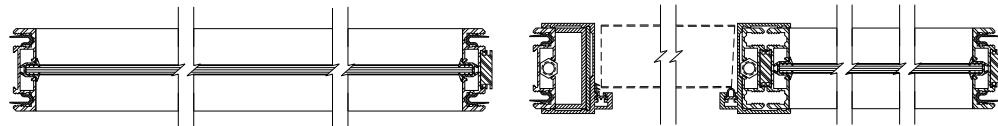

Ceiling Height		
96	8'0"	\$3271
97	8'1"	\$3271
98	8'2"	\$3271
99	8'3"	\$3271
100	8'4"	\$3271
101	8'5"	\$3271
102	8'6"	\$3271
103	8'7"	\$3271
104	8'8"	\$3271
105	8'9"	\$3271
106	8'10"	\$3271
107	8'11"	\$3271
8X	jamb sheet	\$3287
108	9'0"	\$3271
109	9'1"	\$3331
110	9'2"	\$3331
111	9'3"	\$3331
112	9'4"	\$3331
113	9'5"	\$3331
114	9'6"	\$3331
115	9'7"	\$3331
116	9'8"	\$3331
117	9'9"	\$3331
118	9'10"	\$3331
119	9'11"	\$3331
9X	jamb sheet	\$3348
120	10'0"	\$3331
10X	jamb sheet	\$3348

Width	
48	48"

Door Swing	
L	left
R	right

Side Lite Glass Finish		
GR	1/4" clear temp	+\$563
GP	1/4" pattern 62	+\$766
GS	1/4" laminated	+\$1561
GG	1/4" frosted	+\$1956
GL	1/4" white lam	+\$2117
GW	3/8" clear temp	+\$1016
GY	3/8" laminated	+\$2186
GZ	3/8" frosted	+\$2694
GI	3/8" white lam	+\$3545
GC	1/2" clear temp	+\$1482
GJ	1/2" laminated	+\$2969
GU	1/2" frosted	+\$3432
GV	1/2" white lam	+\$3876
GX	custom or CUS	
FX	custom applied film	

Transom Finish		
GR	1/4" clear temp	+\$281
GP	1/4" pattern 62	+\$383
GS	1/4" laminated	+\$781
GG	1/4" frosted	+\$979
GL	1/4" white lam	+\$1058
GW	3/8" clear temp	+\$510
GY	3/8" laminated	+\$1094
GZ	3/8" frosted	+\$1346
GI	3/8" white lam	+\$1771
GC	1/2" clear temp	+\$740
GJ	1/2" laminated	+\$1483
GU	1/2" frosted	+\$1717
GV	1/2" white lam	+\$1938
GX	custom or CUS	
FX	custom applied film	
IN	Insert (Outsert)	Sold Separately

Trim Finish	
B3B2B0	alum
9FA1A0	anodized
EDE9E0	base white
C0B7A8	desert storm
89989D	epoxy blue
4F4546	espresso
918D81	glimmer bronze
48494D	graphite
F3FDFF	ice white
323836	matte slate
B8AEA3	metallic stone
40403F	midnight black
201920	onyx
605746	rust bronze
636D6F	space grey
EAEBE6	stone white
A49E9E	warm grey

Base Height	
00	No Base
04	4"
06	6"

i | 2 | 5 | 7 | 4 | . | | | |

4 | 8 | | |

| | |

| | | |





# i2577 MODULAR CASED OPENING PANEL WITH HARD SURFACE

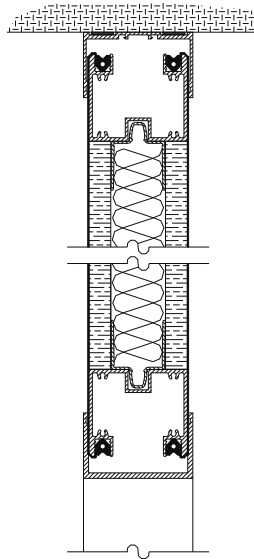
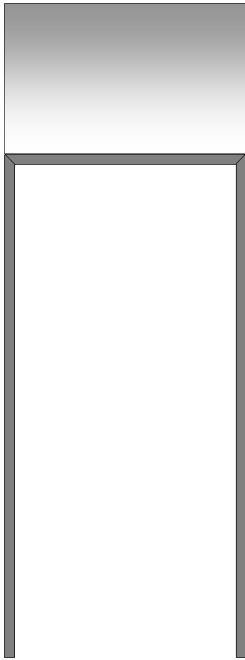

## PRODUCT INFORMATION

### Features:

- Comes with installation clips and screws
- On-site trimming of frame may be required. 1" excess is provided at bottom to accommodate floor-to-ceiling variations

### Specifiers:

- Identify correct ceiling height
- Identify frame width
- Identify aluminum trim finish color
- Identify hard surface finish for each side separately  
For "CUS" customer must provide 1 linear yard per side  
See appendix for vinyl styles and colors

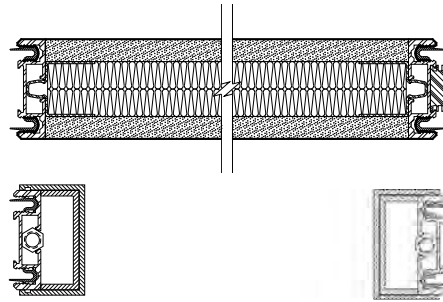

Ceiling Height		
96	8'0"	\$1384
97	8'1"	\$1384
98	8'2"	\$1384
99	8'3"	\$1384
100	8'4"	\$1384
101	8'5"	\$1384
102	8'6"	\$1384
103	8'7"	\$1384
104	8'8"	\$1384
105	8'9"	\$1384
106	8'10"	\$1384
107	8'11"	\$1384
108	9'0"	\$1384
109	9'1"	\$1446
110	9'2"	\$1446
111	9'3"	\$1446
112	9'4"	\$1446
113	9'5"	\$1446
114	9'6"	\$1446
115	9'7"	\$1446
116	9'8"	\$1446
117	9'9"	\$1446
118	9'10"	\$1446
119	9'11"	\$1446
120	10'0"	\$1446

Width		
24	24"	+\$0
30	30"	+\$36
36	36"	+\$72
39	39.5"	+\$108
42	42"	+\$108
48	48"	+\$145

Trim Finish	
B3B2B0	alum
9FA1A0	anodized
EDE9E0	base white
C0B7A8	desert storm
89989D	epoxy blue
4F4546	espresso
918D81	glimmer bronze
48494D	graphite
F3FDFF	ice white
323836	matte slate
B8AEA3	metallic stone
40403F	midnight black
201920	onyx
605746	rust bronze
636D6F	space grey
EAEBE6	stone white
A49E9E	warm grey

Base Height	
00	No Base
04	4"
06	6"

Surface Finish Side 1 / Side 2		
First 2 digits specify series, last 2 specify color		
CUS	customer material	+\$5
AD __	adobe	+\$38
----	category 1	+\$91
----	category 2	+\$101
----	category 3	+\$115
----	category 4	+\$149
----	category 5	+\$206
----	category 6	+\$302
----	category 7	+\$388

i 2 5 7 7 .

# i2578 MODULAR DOUBLE DOOR FRAME PANEL WITH HARD SURFACE

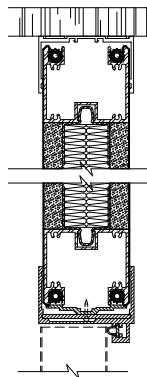
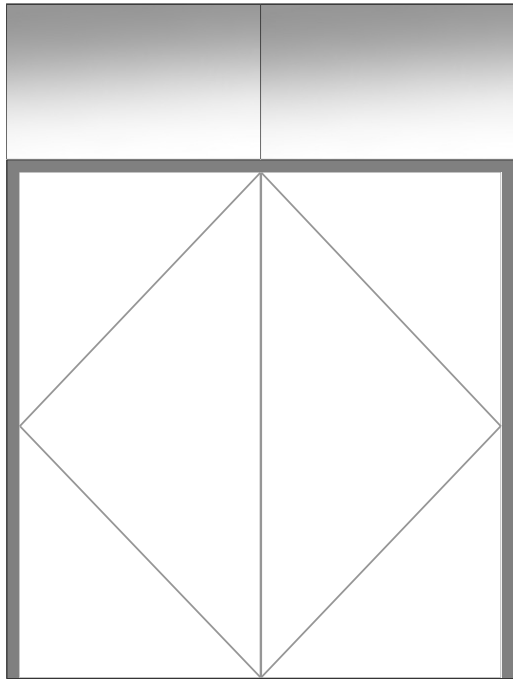

## PRODUCT INFORMATION

### Features:

- Door frame panel comes complete with clip mount to floor
- Accepts standard architectural 3'0"x7'0" or 2'door
- Accepts 6 hinges (3 on each side)
- On-site trimming of frames may be required. 1" excess is provided at bottom to accommodate floor-to-ceiling variations

### Specifiers:

- Identify correct ceiling height
- Use Jamb Sheet (see appendix) for non-standard location of strike plate or hinges
  - Specify "8X" for ceiling heights from 8' to 8'11"
  - Specify "9X" for ceiling heights from 9' to 9'11"
  - Specify "10X" for ceiling heights 10'
- Identify left or right door swing
- Identify aluminum trim finish color
- Identify hard surface finish for each side separately
  - For "CUS" customer must provide 1 linear yard per side
  - See appendix for vinyl styles and colors
- Door, door hinges and door hardware ordered separately

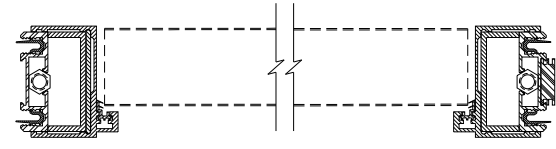
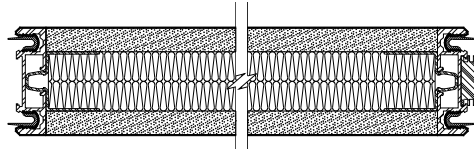

### Ceiling Height

96	8'0"	\$3455
97	8'1"	\$3455
98	8'2"	\$3455
99	8'3"	\$3455
100	8'4"	\$3455
101	8'5"	\$3455
102	8'6"	\$3455
103	8'7"	\$3455
104	8'8"	\$3455
105	8'9"	\$3455
106	8'10"	\$3455
107	8'11"	\$3455
8X	jamb sheet	\$3470
108	9'0"	\$3455
109	9'1"	\$3512
110	9'2"	\$3512
111	9'3"	\$3512
112	9'4"	\$3512
113	9'5"	\$3512
114	9'6"	\$3512
115	9'7"	\$3512
116	9'8"	\$3512
117	9'9"	\$3512
118	9'10"	\$3512
119	9'11"	\$3512
9X	jamb sheet	\$3528
120	10'0"	\$3512
10X	jamb sheet	\$3528

### Width

63	63.5"	+\$0
75	75.5"	+\$719

### Trim Finish

B3B2B0	alum
9FA1A0	anodized
EDE9E0	base white
C0B7A8	desert storm
89989D	epoxy blue
4F4546	espresso
918D81	glimmer bronze
48494D	graphite
F3FDFF	ice white
323836	matte slate
B8AEA3	metallic stone
40403F	midnight black
201920	onyx
605746	rust bronze
636D6F	space grey
EAEBE6	stone white
A49E9E	warm grey

### Base Height

00	No Base
04	4"
06	6"

### Surface Finish Side 1 / Side 2

First 2 digits specify series, last 2 specify color

CUS	customer material	+\$6
AD	adobe	+\$52
----	category 1	+\$121
----	category 2	+\$134
----	category 3	+\$154
----	category 4	+\$198
----	category 5	+\$275
----	category 6	+\$402
----	category 7	+\$517

i 2 5 7 8 .

# i2579 MODULAR DOUBLE CASED OPENING PANEL WITH HARD SURFACE

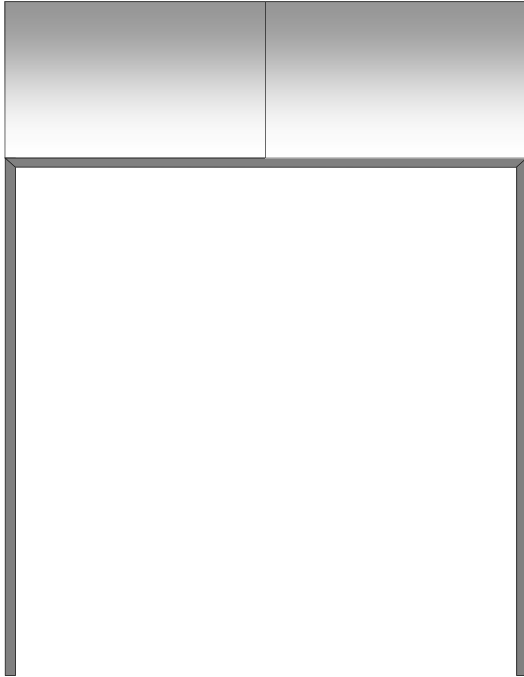

## PRODUCT INFORMATION

### Features:

- On-site trimming of frames may be required. 1" excess is provided at bottom to accommodate floor-to-ceiling variations

### Specifiers:

- Identify correct ceiling height
- Identify frame width
- Identify trim finish
- Identify hard surface finish for each side separately  
For "CUS" customer must provide 1 linear yard per side  
See appendix for vinyl styles and colors

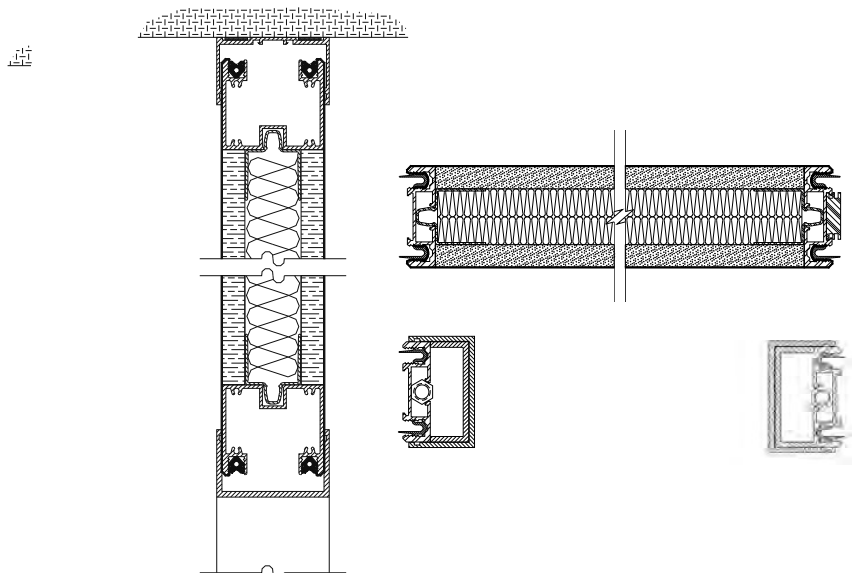

Ceiling Height		
96	8'0"	\$3455
97	8'1"	\$3455
98	8'2"	\$3455
99	8'3"	\$3455
100	8'4"	\$3455
101	8'5"	\$3455
102	8'6"	\$3455
103	8'7"	\$3455
104	8'8"	\$3455
105	8'9"	\$3455
106	8'10	\$3455
107	8'11	\$3455
108	9'0"	\$3455
109	9'1"	\$3512
110	9'2"	\$3512
111	9'3"	\$3512
112	9'4"	\$3512
113	9'5"	\$3512
114	9'6"	\$3512
115	9'7"	\$3512
116	9'8"	\$3512
117	9'9"	\$3512
118	9'10"	\$3512
119	9'11"	\$3512
120	10'0"	\$3512

Width		
63	63.5"	+\$0
75	75.5"	+\$719

Trim Finish	
B3B2B0	alum
9FA1A0	anodized
EDE9E0	base white
C0B7A8	desert storm
89989D	epoxy blue
4F4546	espresso
918D81	glimmer bronze
48494D	graphite
F3FDFF	ice white
323836	matte slate
B8AEA3	metallic stone
40403F	midnight black
201920	onyx
605746	rust bronze
636D6F	space grey
EAEBE6	stone white
A49E9E	warm grey

Base Height	
00	No Base
04	4"
06	6"

Surface Finish Side 1 / Side 2		
First 2 digits specify series, last 2 specify color		
CUS	customer material	+\$10
AD __	adobe	+\$77
----	category 1	+\$182
----	category 2	+\$202
----	category 3	+\$230
----	category 4	+\$298
----	category 5	+\$412
----	category 6	+\$604
----	category 7	+\$778

i | 2 | 5 | 7 | 9 | . | | | | | |

| | |

| | |

| | |

| | | | | | | | | |



# i2580 48" DOOR FRAME PANEL WITH HARD SURFACE

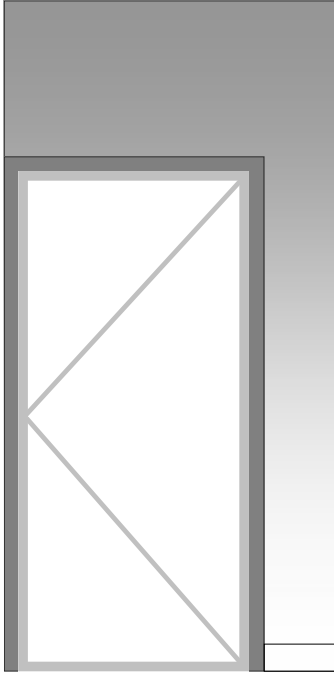

## PRODUCT INFORMATION

### Features:

- Door frame panel comes complete with clip mount to floor
- Center line of strike plate is 38" ±1" from finished floor, depending on variation in floor-to-ceiling height
- Choice of left or right door swing
- Accepts standard architectural 3'0" x 7'0" door
- Accepts 3 hinges and standard ASA 4 7/8" strike plate
- On-site trimming of frames may be required. 1" excess is provided at bottom to accommodate floor-to-ceiling variations

### Specifiers:

- Identify correct ceiling height
- Use Jamb Sheet (see appendix) for non-standard location of strike plate or hinges
- Identify left or right door swing
- Identify aluminum trim finish color
- Identify hard surface finish for each side separately  
For "CUS" customer must provide 3.5 linear yards per side  
See appendix for vinyl styles and colors
- Door, door hinges, base plug and door hardware ordered separately

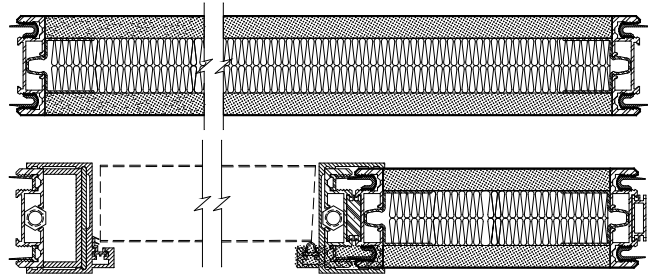
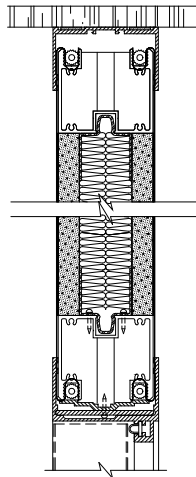

### Ceiling Height

96	8'0"	\$2765
97	8'1"	\$2765
98	8'2"	\$2765
99	8'3"	\$2765
100	8'4"	\$2765
101	8'5"	\$2765
102	8'6"	\$2765
103	8'7"	\$2765
104	8'8"	\$2765
105	8'9"	\$2765
106	8'10"	\$2765
107	8'11"	\$2765
108	9'0"	\$2765
109	9'1"	\$2863
110	9'2"	\$2863
111	9'3"	\$2863
112	9'4"	\$2863
113	9'5"	\$2863
114	9'6"	\$2863
115	9'7"	\$2863
116	9'8"	\$2863
117	9'9"	\$2863
118	9'10"	\$2863
119	9'11"	\$2863
120	10'0"	\$2863

Width	
48	48"

Door Swing	
L	left
R	right

Trim Finish	
B3B2B0	alum
9FA1A0	anodized
EDE9E0	base white
C0B7A8	desert storm
89989D	epoxy blue
4F4546	espresso
918D81	glimmer bronze
48494D	graphite
F3FDFD	ice white
323836	matte slate
B8AEA3	metallic stone
40403F	midnight black
201920	onyx
605746	rust bronze
636D6F	space grey
EAEBE6	stone white
A49E9E	warm grey

Surface Finish Side 1 / Side 2		
First 2 digits specify series, last 2 specify color		
CUS	customer material	+\$10
AD	adobe	+\$77
----	category 1	+\$182
----	category 2	+\$202
----	category 3	+\$230
----	category 4	+\$298
----	category 5	+\$412
----	category 6	+\$604
----	category 7	+\$778

i 2 5 8 0 .

4 8

# i2581 MODULAR DOUBLE CASED OPENING PANEL WITH GLASS TRANSOM

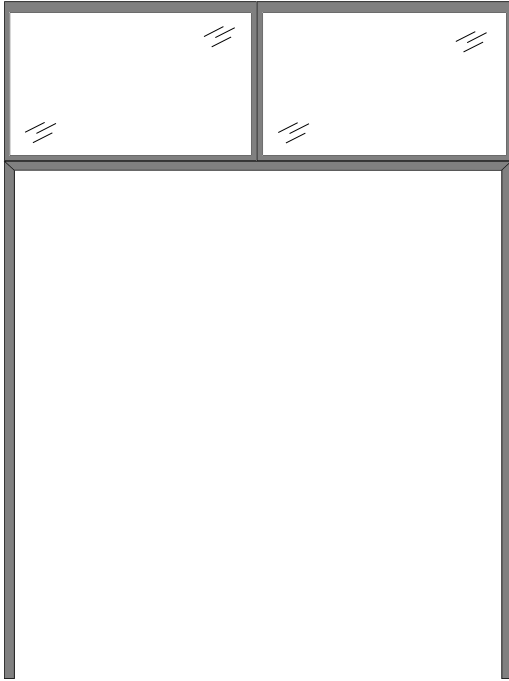

## PRODUCT INFORMATION

### Features:

- On-site trimming of frames may be required. 1" excess is provided at bottom to accommodate floor-to-ceiling variations
- Glass transom sill height matches standard 86" sill height on wall panels

### Specifiers:

- Identify correct ceiling height
- Identify frame width
- Identify glass finish
  - See appendix for "FX" custom applied film options
- Identify aluminum trim finish
- Identify base height

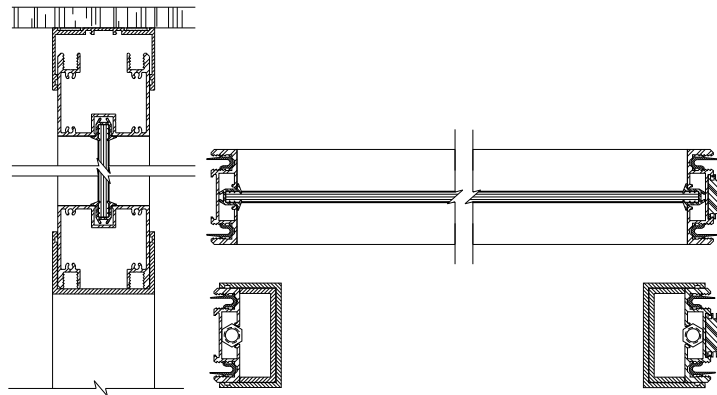

Ceiling Height		
96	8'0"	\$1768
97	8'1"	\$1768
98	8'2"	\$1768
99	8'3"	\$1768
100	8'4"	\$1768
101	8'5"	\$1768
102	8'6"	\$1768
103	8'7"	\$1768
104	8'8"	\$1768
105	8'9"	\$1768
106	8'10	\$1768
107	8'11	\$1768
108	9'0"	\$1768
109	9'1"	\$1930
110	9'2"	\$1930
111	9'3"	\$1930
112	9'4"	\$1930
113	9'5"	\$1930
114	9'6"	\$1930
115	9'7"	\$1930
116	9'8"	\$1930
117	9'9"	\$1930
118	9'10"	\$1930
119	9'11"	\$1930
120	10'0"	\$1930

Width	
63	63.5"
75	75.5"
85	85.5"

	Glass Finish		
		63.5" and 75.5" Width	87.5" Width
GR	1/4" clear temp	+\$421	+\$527
GP	1/4" pattern 62	+\$575	+\$719
GS	1/4" laminated	+\$1171	+\$1463
GG	1/4" frosted	+\$1468	+\$1835
GL	1/4" white lam	+\$1588	+\$1985
GW	3/8" clear temp	+\$763	+\$954
GY	3/8" laminated	+\$1640	+\$2051
GZ	3/8" frosted	+\$2018	+\$2525
GI	3/8" white lam	+\$2656	+\$3322
GC	1/2" clear temp	+\$1111	+\$1390
GJ	1/2" laminated	+\$2225	+\$2784
GU	1/2" frosted	+\$2575	+\$3217
GV	1/2" white lam	+\$2905	+\$3634
GX	custom or CUS		
FX	custom applied film		

Trim Finish	
B3B2B0	alum
9FA1A0	anodized
EDE9E0	base white
C0B7A8	desert storm
89989D	epoxy blue
4F4546	espresso
918D81	glimmer bronze
48494D	graphite
F3FDFF	ice white
323836	matte slate
B8AEA3	metallic stone
40403F	midnight black
201920	onyx
605746	rust bronze
636D6F	space grey
EAEBE6	stone white
A49E9E	warm grey

Base Height	
00	No Base
04	4"
06	6"

i | 2 | 5 | 8 | 1 | . | | | |

| | | | |

# FURNITURE INTEGRATION

**i2610 A TYPE WALLSTRIP CONNECTOR, PANEL TO PANEL**

**i2710 B TYPE WALLSTRIP CONNECTOR, PANEL TO PANEL**

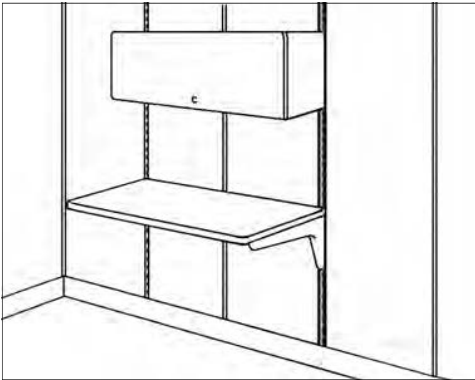

**PRODUCT INFORMATION**

**Features:**

- Joins 2 gypsum panels (grooved ends) and provides hang-on capability
- Accepts Wallstrip Closure (i2631), Wallstrip Flat Cover (i2632) or Wallstrip Aluminum Flat Cover (i2633) at any panel connection to conceal slotted standard

**Specifiers:**

- Identify height
- Identify trim finish

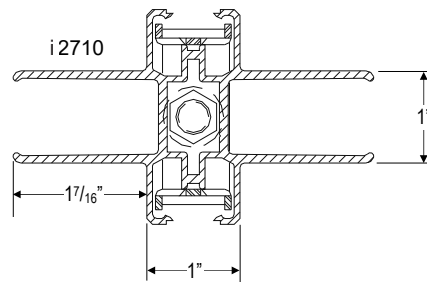
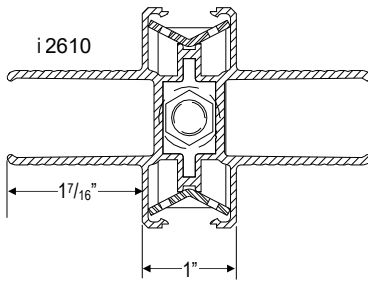

Product Number & Height		
<b>A Type</b>		
i2610.108	9'	\$486
i2610.120	10'	\$524
<b>B Type</b>		
i2710.108	9'	\$510
i2710.120	10'	\$548

Trim Finish	
B3B2B0	alum
9FA1A0	anodized
EDE9E0	base white
C0B7A8	desert storm
89989D	epoxy blue
4F4546	espresso
918D81	glimmer bronze
48494D	graphite
F3FDFF	ice white
323836	matte slate
B8AEA3	metallic stone
40403F	midnight black
201920	onyx
605746	rust bronze
636D6F	space grey
EAEBE6	stone white
A49E9E	warm grey

i 2 | 1 0 . | | |

| | |

- i2611 A TYPE WALLSTRIP CONNECTOR, PANEL TO CORNER**
- i2661 A TYPE WALLSTRIP CONNECTOR, PANEL TO CORNER**
- i2711 B TYPE WALLSTRIP CONNECTOR, PANEL TO CORNER**

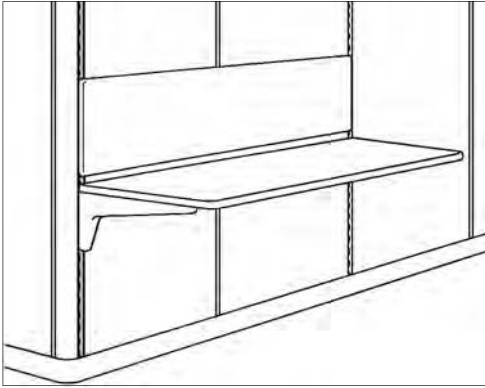

**PRODUCT INFORMATION**

**Features:**

- Joins a gypsum panel (grooved end) to modular corner, spacer, or intersection and provides hang-on capability.
- Accepts Wallstrip Closure (i 2631), Wallstrip Flat Cover (i 2632) or Wallstrip Aluminum Flat Cover (i 2633) at any panel connection to conceal slotted standard

**Specifiers:**

- Identify height
- Identify trim finish

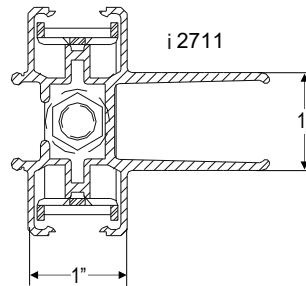
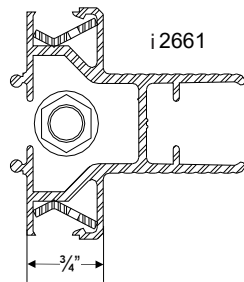
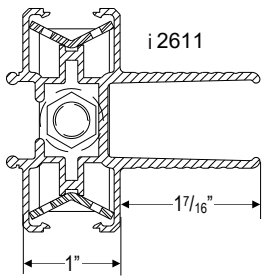

Product Number & Height		
<b>A Type</b>		
<b>i2611.108</b>	9'	\$426
<b>i2611.120</b>	10'	\$457
<b>A Type</b>		
<b>i2661.108</b>	9'	\$511
<b>i2661.120</b>	10'	\$539
<b>B Type</b>		
<b>i2711.108</b>	9'	\$455
<b>i2711.120</b>	10'	\$487

Trim Finish	
<b>B3B2B0</b>	alum
<b>9FA1A0</b>	anodized
<b>EDE9E0</b>	base white
<b>C0B7A8</b>	desert storm
<b>89989D</b>	epoxy blue
<b>4F4546</b>	espresso
<b>918D81</b>	glimmer bronze
<b>48494D</b>	graphite
<b>F3FDFF</b>	ice white
<b>323836</b>	matte slate
<b>B8AEA3</b>	metallic stone
<b>40403F</b>	midnight black
<b>201920</b>	onyx
<b>605746</b>	rust bronze
<b>636D6F</b>	space grey
<b>EAEBE6</b>	stone white
<b>A49E9E</b>	warm grey

i 2 | | | 1 . | | |

| | |

- i2612 A TYPE WALL STRIP/CONNECTOR, PANEL TO JAMB**
- i2662 A TYPE WALL STRIP/CONNECTOR, PANEL TO JAMB**
- i2712 B TYPE STRIP/CONNECTOR, PANEL TO JAMB**

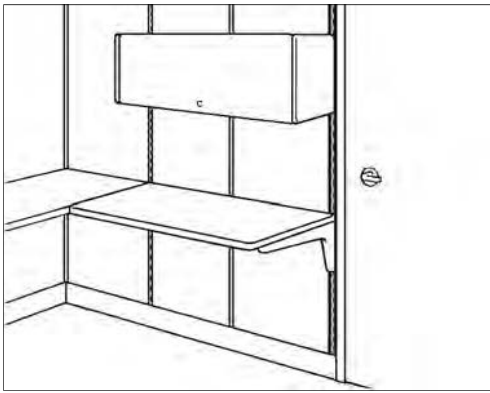

**PRODUCT INFORMATION**

**Features:**

- Joins a panel to a door or glazing jamb, or a Wall Start (i 2310) and provides hang-on capability.
- Accepts Wallstrip Closure (i 2631) at any panel connection to conceal slotted standard

**Specifiers:**

- Identify product number and height
- Identify trim finish

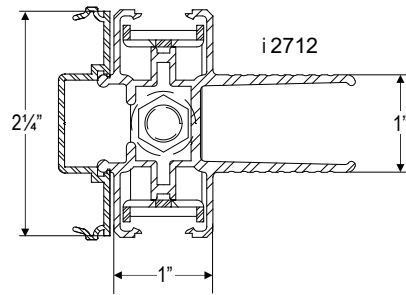
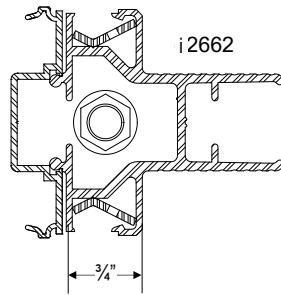
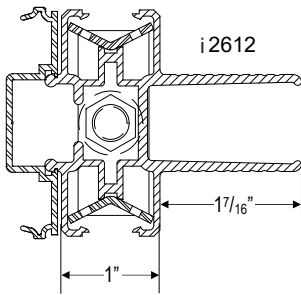

Product Number & Height		
<b>A Type</b>		
i2612.108	9'	\$511
i2612.120	10'	\$551
<b>A Type</b>		
i2662.108	9'	\$595
i2662.120	10'	\$636
<b>B Type</b>		
i2712.108	9'	\$535
i2712.120	10'	\$575

Trim Finish	
B3B2B0	alum
9FA1A0	anodized
EDE9E0	base white
C0B7A8	desert storm
89989D	epoxy blue
4F4546	espresso
918D81	glimmer bronze
48494D	graphite
F3FDFF	ice white
323836	matte slate
B8AEA3	metallic stone
40403F	midnight black
201920	onyx
605746	rust bronze
636D6F	space grey
EAEBE6	stone white
A49E9E	warm grey

i 2 | | | 2 . | | |

| | |

i2620 A TYPE WALL START  
i2670 A TYPE WALL START  
i2720 B TYPE WALL START

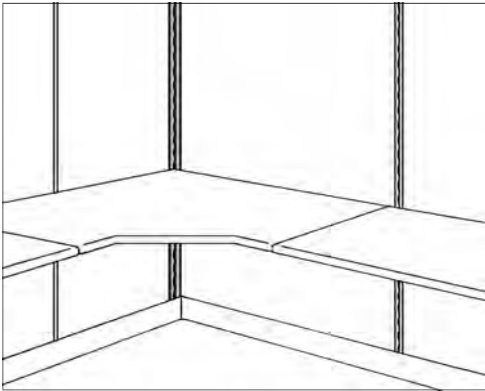

**PRODUCT INFORMATION**

**Features:**

- Allows a systems Corner Work Surface to be hung at the intersection of a Movable Wall panel and a fixed wall
- Clipped at the top for attachment to the Ceiling Runner (i2110)
- Accepts Wallstrip Closure (i2631) at any panel connection to conceal slotted standard

**Specifiers:**

- Identify product number and height

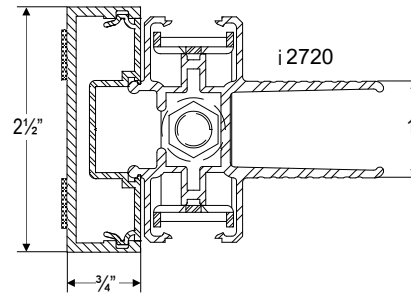
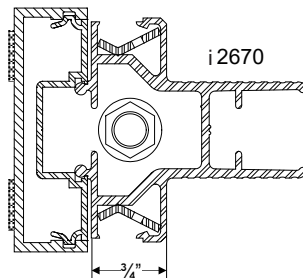
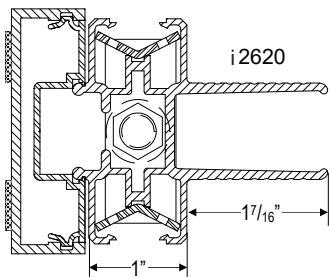

Product Number & Height		
<b>A Type</b>		
i 2620.108	9'	\$632
i 2620.120	10'	\$684
<b>A Type</b>		
i 2670.108	9'	\$718
i 2670.120	10'	\$768
<b>B Type</b>		
i 2720.108	9'	\$612
i 2720.120	10'	\$691

Trim Finish	
B3B2B0	alum
9FA1A0	anodized
EDE9E0	base white
C0B7A8	desert storm
89989D	epoxy blue
4F4546	espresso
918D81	glimmer bronze
48494D	graphite
F3FDFF	ice white
323836	matte slate
B8AEA3	metallic stone
40403F	midnight black
201920	onyx
605746	rust bronze
636D6F	space grey
EAEBE6	stone white
A49E9E	warm grey

i 2 | | | 0 . | | |

| | |

# i2615 MODULAR WALLSTRIP CONNECTOR

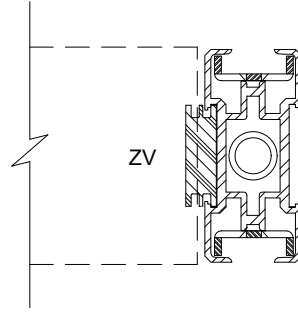
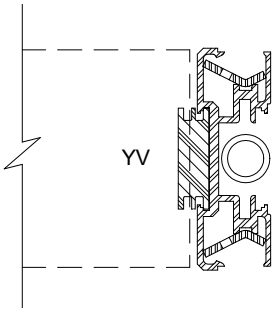
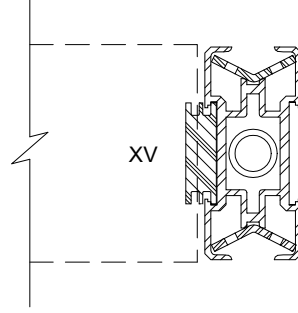
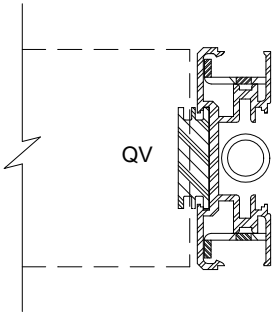

## PRODUCT INFORMATION

### Features:

- Structural, aluminum extrusion with steel inserts
- Allows furniture component support to be added to existing product
- Slides into end of modular panel or modular connector before installation
- Semi-rigid PVC continuous "zipclip" included
- Part dimension: **QV** 13/16"  
**YV** 13/16"  
**XV** 1-1/16"  
**ZV** 1-1/16"

Note: **QV & YV** are only required at modular connectors (i.e. corners & 3-ways) to maintain the correct dimension creep.

Wallstrip adds include 1/16" gain from clip

### Specifiers:

- Identify minimum panel height
- Identify trim finish
- Identify wallstrip unit according to furniture support and layout requirement

Ceiling Height		
96	8'0"	\$431
97	8'1"	\$431
98	8'2"	\$431
99	8'3"	\$431
100	8'4"	\$431
101	8'5"	\$431
102	8'6"	\$431
103	8'7"	\$431
104	8'8"	\$431
105	8'9"	\$431
106	8'10"	\$431
107	8'11"	\$431
108	9'0"	\$431
109	9'1"	\$452
110	9'2"	\$452
111	9'3"	\$452
112	9'4"	\$452
113	9'5"	\$452
114	9'6"	\$452
115	9'7"	\$452
116	9'8"	\$452
117	9'9"	\$452
118	9'10"	\$452
119	9'11"	\$452
120	10'0"	\$452

Trim Finish	
B3B2B0	alum
9FA1A0	anodized
EDE9E0	base white
C0B7A8	desert storm
89989D	epoxy blue
4F4546	espresso
918D81	glimmer bronze
48494D	graphite
F3FDFF	ice white
323836	matte slate
B8AEA3	metallic stone
40403F	midnight black
201920	onyx
605746	rust bronze
636D6F	space grey
EAEBE6	stone white
A49E9E	warm grey

Wallstrip	
QV	13/16"
XV	13/16"
YV	1-1/16"
ZV	1-1/16"

i | 2 | 6 | 1 | 5 | . | | |

| | |

| | |



# i2631 WALLSTRIP CLOSURE

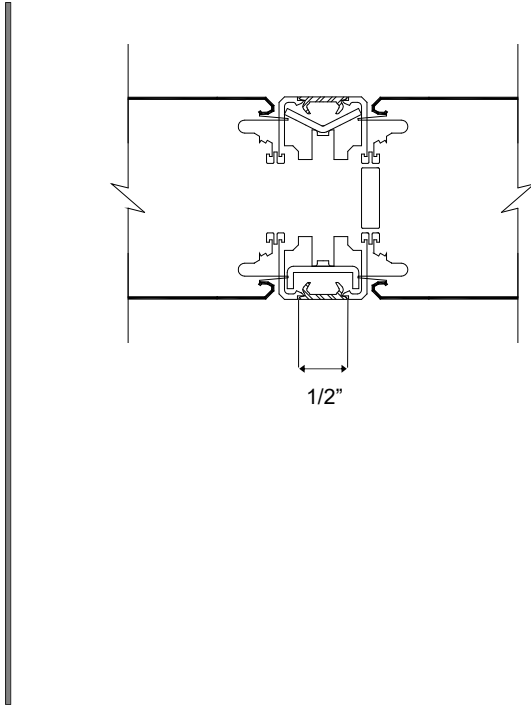

## PRODUCT INFORMATION

### Features:

- Rigid extruded aluminum snap fit closure
- Installer trims from 10' length to fit on site to either full height or above and below furniture component interface
- Package contains 10 units

### Specifiers:

- Select trim color

Wallstrip Closure		Trim Finish
i2631.A		B3B2B0 alum
aluminum	\$511	9FA1A0 anodized
pack of 10		EDE9E0 base white
		C0B7A8 desert storm
		89989D epoxy blue
		4F4546 espresso
		918D81 glimmer bronze
		48494D graphite
		F3DFDF ice white
		323836 matte slate
		B8AEA3 metallic stone
		40403F midnight black
		201920 onyx
		605746 rust bronze
		636D6F space grey
		EAEBE6 stone white
		A49E9E warm grey

i 2 6 3 1 . A

# i2632 WALLSTRIP FLAT COVER

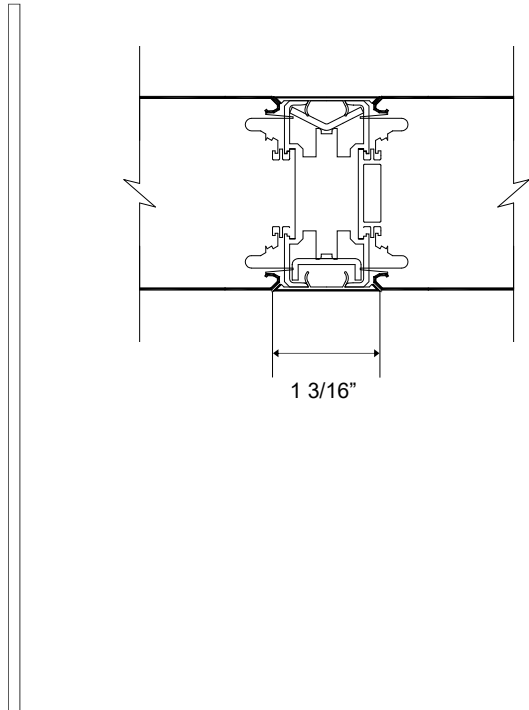

## PRODUCT INFORMATION

### Features:

- Rigid vinyl receiver clips in wallstrips
- Selection of surface finish
- Installer trims from 10' length to fit on site to either full height or above and below furniture component interface

### Specifiers:

- Identify surface finish  
For "CUS" customer must provide 3.5 linear yards per 12 units  
See appendix for vinyl styles and colors

Wallstrip Flat Cover			Surface Finish	
			First 2 digits specify series, last 2 specify color	
i2632	10'0"	\$88	CUS	customer material +\$8
			AD --	adobe +\$14
			----	category 1 +\$35
			----	category 2 +\$38
			----	category 3 +\$44
			----	category 4 +\$58
			----	category 5 +\$80
			----	category 6 +\$106
			----	category 7 +\$149

i | 2 | 6 | 3 | 2 | . |

| | | | |

# i2633 WALLSTRIP ALUMINUM FLAT COVER

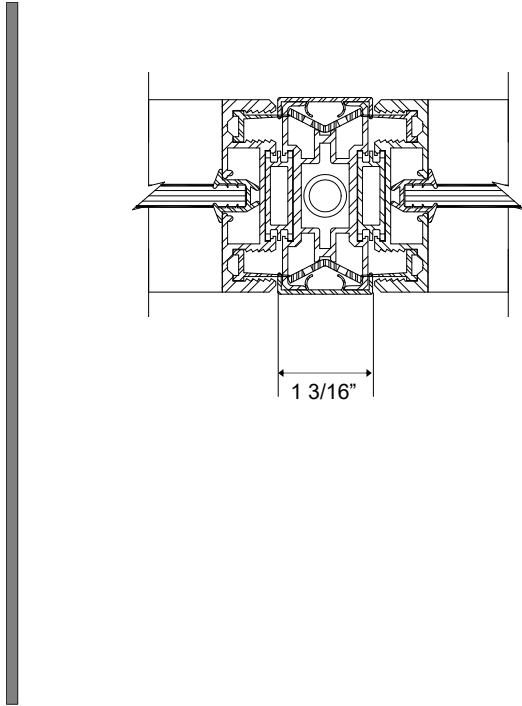

## PRODUCT INFORMATION

### Features:

- Extruded aluminum snap fits into wallstrip
- Selection of trim finish
- Installer trims from 10' length to fit on site to either full height or above and below furniture component interface

### Specifiers:

- Identify trim finish

Aluminum Flat Cover			Trim Finish
i2633	10'0"	\$76	<b>B3B2B0</b> alum <b>9FA1A0</b> anodized <b>EDE9E0</b> base white <b>C0B7A8</b> desert storm <b>89989D</b> epoxy blue <b>4F4546</b> espresso <b>918D81</b> glimmer bronze <b>48494D</b> graphite <b>F3FDFF</b> ice white <b>323836</b> matte slate <b>B8AEA3</b> metallic stone <b>40403F</b> midnight black <b>201920</b> onyx <b>605746</b> rust bronze <b>636D6F</b> space grey <b>EAEBE6</b> stone white <b>A49E9E</b> warm grey

i | 2 | 6 | 3 | 3 | . |

# i2640 A TYPE PANEL ADAPTER, 90° CORNER

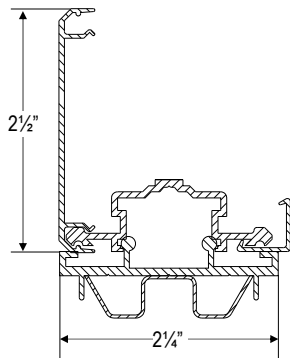
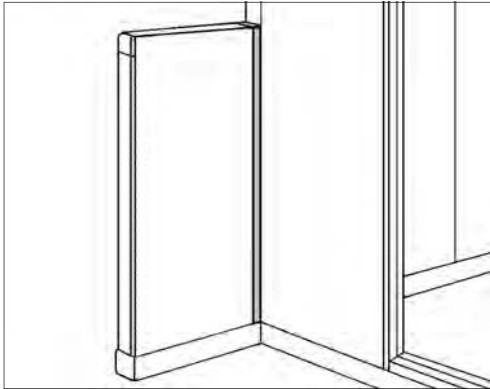

## PRODUCT INFORMATION

### Features:

- Permits attachment of systems panels to modular connector
- Draw Rod ordered separately
- Modular connector ordered separately

### Specifiers:

- Identify adapter height
  - For 34" & 39" panel heights, specify "39"
  - For 42" & 47" panel heights, specify "47"
  - For 48 & 53" panel heights, specify "53"
  - For 62" & 67" panel heights, specify "67"
  - For 80" & 85" panel heights, specify "85"
- Identify trim finish
- Identify surface finish
  - See appendix for vinyl styles and colors
  - Specify "0000" for unfinished units; units must be field-finished
- For "CUS" option - supply 2.5 linear yards (min) per 4 units

Adapter Height		
39	39"	\$154
47	47"	\$169
53	53"	\$185
67	67"	\$203
85	85"	\$218

Trim Finish	
B3B2B0	alum
9FA1A0	anodized
EDE9E0	base white
C0B7A8	desert storm
89989D	epoxy blue
4F4546	espresso
918D81	glimmer bronze
48494D	graphite
F3FDFF	ice white
323836	matte slate
B8AEA3	metallic stone
40403F	midnight black
201920	onyx
605746	rust bronze
636D6F	space grey
EAEBE6	stone white
A49E9E	warm grey

Surface Finish		
First 2 digits specify series, last 2 specify color		
CUS	customer material	+\$8
AD __	adobe	+\$14
----	category 1	+\$35
----	category 2	+\$38
----	category 3	+\$44
----	category 4	+\$58
----	category 5	+\$80
----	category 6	+\$106
----	category 7	+\$149

i 2 6 4 0 .

# i2641 A TYPE PANEL ADAPTER, SPACER OR MODULAR 3-WAY

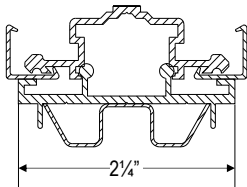
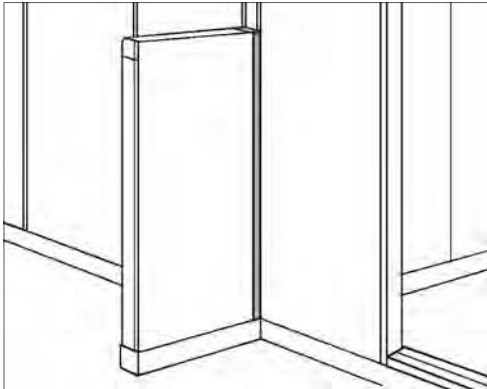

## PRODUCT INFORMATION

### Features:

- Permits attachment of systems panel to modular connector
- Draw Rod ordered separately
- Modular connector ordered separately

### Specifiers:

- Identify adapter height
  - For 34" & 39" panel heights, specify "39"
  - For 42" & 47" panel heights, specify "47"
  - For 48 & 53" panel heights, specify "53"
  - For 62" & 67" panel heights, specify "67"
  - For 80" & 85" panel heights, specify "85"
- Identify trim finish

Adapter Height			Trim Finish	
39	39"	\$140	B3B2B0	alum
47	47"	\$156	9FA1A0	anodized
53	53"	\$173	EDE9E0	base white
67	67"	\$202	C0B7A8	desert storm
85	85"	\$217	89989D	epoxy blue
			4F4546	espresso
			918D81	glimmer bronze
			48494D	graphite
			F3FDFF	ice white
			323836	matte slate
			B8AEA3	metallic stone
			40403F	midnight black
			201920	onyx
			605746	rust bronze
			636D6F	space grey
			EAEBE6	stone white
			A49E9E	warm grey

i | 2 | 6 | 4 | 1 | . | | | | |

# i2642 A TYPE PANEL ADAPTER, 135° CORNER

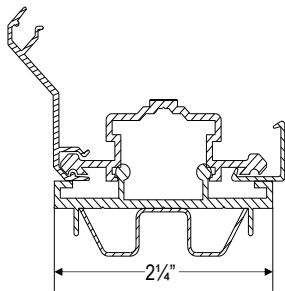
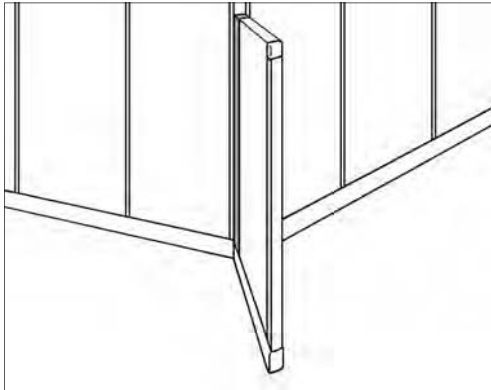

## PRODUCT INFORMATION

### Features:

- Permits attachment of systems panels to modular connector
- Draw Rod ordered separately
- Modular connector ordered separately

### Specifiers:

For 34" & 39" panel heights, specify "39"

For 42" & 47" panel heights, specify "47"

For 48" & 53" panel heights, specify "53"

For 62" & 67" panel heights, specify "67"

For 80" & 85" panel heights, specify "85"

- Identify trim finish
- Identify surface finish  
See appendix for vinyl styles and colors  
Specify "0000" for unfinished units; units must be field-finished
- For "CUS" option - supply 2.5 linear yards (min) per 4 units

Adapter Height			Trim Finish		Surface Finish		
			First 2 digits specify series, last 2 specify color				
39	39"	\$193	B3B2B0	alum	CUS	customer material	+\$8
47	47"	\$209	9FA1A0	anodized	AD	adobe	+\$14
53	53"	\$226	EDE9E0	base white	----	category 1	+\$35
67	67"	\$245	C0B7A8	desert storm	----	category 2	+\$38
85	85"	\$260	89989D	epoxy blue	----	category 3	+\$44
			4F4546	espresso	----	category 4	+\$58
			918D81	glimmer bronze	----	category 5	+\$80
			48494D	graphite	----	category 6	+\$106
			F3FDFF	ice white	----	category 7	+\$149
			323836	matte slate			
			B8AEA3	metallic stone			
			40403F	midnight black			
			201920	onyx			
			605746	rust bronze			
			636D6F	space grey			
			EAEBE6	stone white			
			A49E9E	warm grey			

i | 2 | 6 | 4 | 2 | . | | |

| | |

| | | | |

# i2644 A TYPE OFFSET PANEL ADAPTER, 90° CORNER

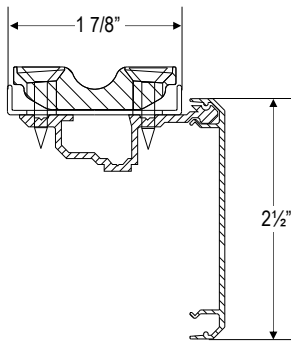
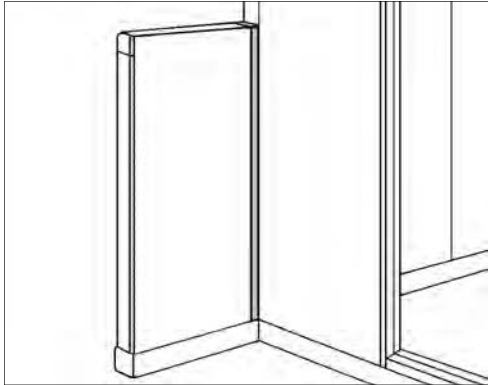

## PRODUCT INFORMATION

### Features:

- Permits attachment of systems panel to modular connector
- Requires Draw Rod of equal height to match panel, ordered separately
- Modular connector ordered separately

### Specifiers:

- Identify adapter height
  - For 34" & 39" panel heights, specify "39"
  - For 42" & 47" panel heights, specify "47"
  - For 48" & 53" panel heights, specify "53"
  - For 62" & 67" panel heights, specify "67"
  - For 80" & 85" panel heights, specify "85"
- Identify surface finish
  - See appendix for vinyl styles and colors
  - Specify "0000" for unfinished units; units must be field-finished
- For "CUS" option - supply 2.5 linear yards (min) per 4 units

Adapter Height			Surface Finish	
			First 2 digits specify series, last 2 specify color	
31	31"	\$175	CUS	customer material +\$8
40	40"	\$178	AD --	adobe +\$14
54	54"	\$180	----	category 1 +\$35
63	63"	\$185	----	category 2 +\$38
68	68"	\$188	----	category 3 +\$44
80	80"	\$216	----	category 4 +\$58
			----	category 5 +\$80
			----	category 6 +\$106
			----	category 7 +\$149

i | 2 | 6 | 4 | 4 | . | | | | | | | | |

# i2645 A TYPE PANEL ADAPTER FOR SPACER

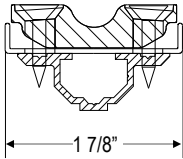
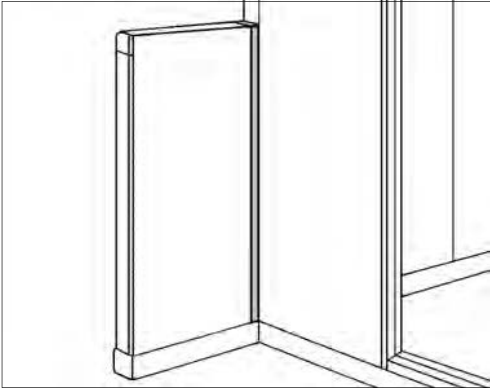

## PRODUCT INFORMATION

### Features:

- Permits attachment of systems panel to Modular Spacer
- Requires Draw Rod of equal height to match panel, ordered separately
- Modular Spacer for ordered separately

### Specifiers:

- Identify adapter height
  - For 31" panel height, specify "31"
  - For 40" panel height, specify "40"
  - For 54" panel height, specify "54"
  - For 63" panel height, specify "63"
  - For 68" panel height, specify "68"
  - For 80" panel height, specify "80"

Adapter Height		
31	31"	\$118
40	40"	\$121
54	54"	\$126
63	63"	\$131
68	68"	\$137
80	80"	\$145

i 2 6 4 5 .



# i2646 A TYPE OFFSET PANEL ADAPTER, SPACER OR MODULAR 3-WAY

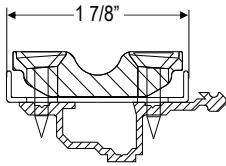
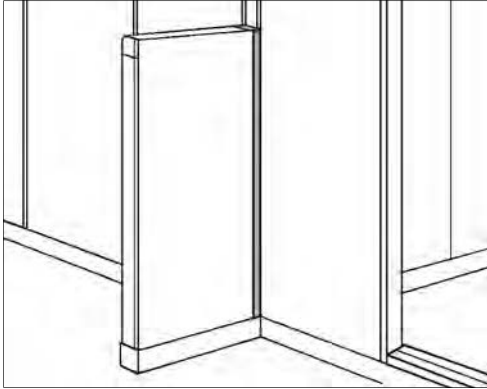

## PRODUCT INFORMATION

### Features:

- Permits attachment of systems panel to modular connector
- Requires Draw Rod of equal height to match panel, ordered separately
- Modular connector ordered separately

### Specifiers:

- Identify adapter height
  - For 31" panel height, specify "31"
  - For 40" panel height, specify "40"
  - For 54" panel height, specify "54"
  - For 63" panel height, specify "63"
  - For 68" panel height, specify "68"
  - For 80" panel height, specify "80"

Adapter Height		
31	31"	\$137
40	40"	\$140
54	54"	\$145
63	63"	\$151
68	68"	\$156
80	80"	\$164

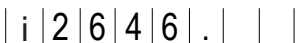

# i2647 A TYPE OFFSET PANEL ADAPTER, 135° CORNER

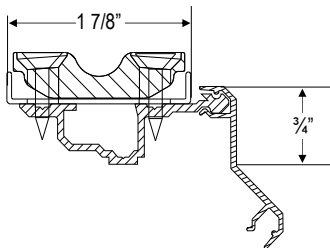
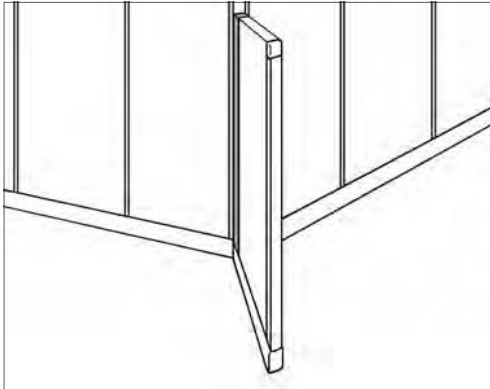

## PRODUCT INFORMATION

### Features:

- Permits attachment of systems panel to modular connector
- Requires Draw Rod of equal height to match panel, ordered separately
- Modular connector ordered separately

### Specifiers:

- Identify adapter height
  - For 31" panel height, specify "31"
  - For 40" panel height, specify "40"
  - For 54" panel height, specify "54"
  - For 63" panel height, specify "63"
  - For 68" panel height, specify "68"
  - For 80" panel height, specify "80"
- Identify surface finish
  - See appendix for vinyl styles and colors
  - Specify "0000" for unfinished units; units must be field-finished
- For "CUS" option - supply 2.5 linear yards (min) per 6 units

Adapter Height			Surface Finish		
			First 2 digits specify series, last 2 specify color		
31	31"	\$179	CUS	customer material	+\$8
40	40"	\$180	AD __	adobe	+\$14
54	54"	\$185	----	category 1	+\$35
63	63"	\$188	----	category 2	+\$38
68	68"	\$193	----	category 3	+\$44
80	80"	\$212	----	category 4	+\$58
			----	category 5	+\$80
			----	category 6	+\$106
			----	category 7	+\$149

i | 2 | 6 | 4 | 7 | . | | | | |

# i2740 B TYPE PANEL ADAPTER

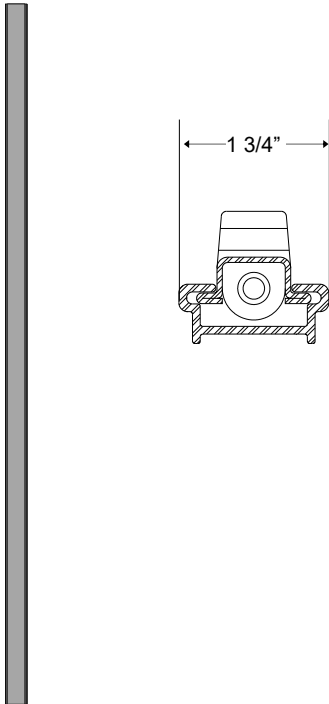

Systems Panel Height

Panel Attachment Height		
38	38"	\$215
46	46"	\$235
54	54"	\$235
62	62"	\$289
70	70"	\$289
86	86"	\$346

## PRODUCT INFORMATION

### Features:

- Metal components allow for structural connection to systems frame (ordered separately)
- Attaches to modular connector
- Allows electrical connection through base
- Includes draw channel connector

### Specifiers:

- Identify height of adapter as required by systems frame height

| i | 2 | 7 | 4 | 0 | . | | |

# ARCHITECTURAL TRIM COMPONENTS

# i2810 CEILING RUNNER TRIM, FIXED WALL

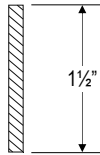
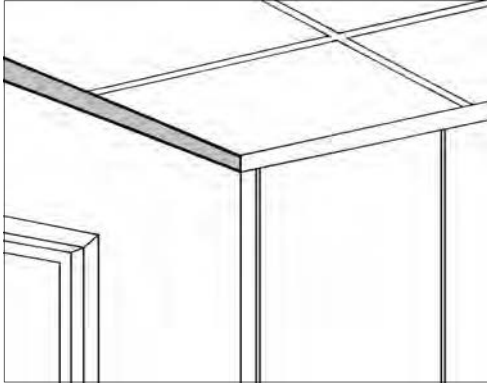

## PRODUCT INFORMATION

### Features:

- 12' flat aluminum extrusion simulates the appearance of a Ceiling Runner (i2110) on fixed walls
- Includes installation screws

**Note:** Measure overall length of wall run, including door and glazed openings, and round up to next 2' increment.

Example: A 12'10" wall run rounds up to 14'

Add up all rounded wall run lengths and divide by 12 for order quantity

### Specifiers:

- Identify trim finish

Product Number	Trim Finish
i2810	\$88
B3B2B0	alum
9FA1A0	anodized
EDE9E0	base white
C0B7A8	desert storm
89989D	epoxy blue
4F4546	espresso
918D81	glimmer bronze
48494D	graphite
F3FDFF	ice white
323836	matte slate
B8AEA3	metallic stone
40403F	midnight black
201920	onyx
605746	rust bronze
636D6F	space grey
EAEBE6	stone white
A49E9E	warm grey

i | 2 | 8 | 1 | 0 | . |

□ □

# i2812 WALL CLIP, VINYL BASE TO FIXED WALL

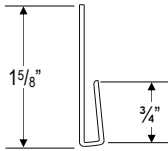
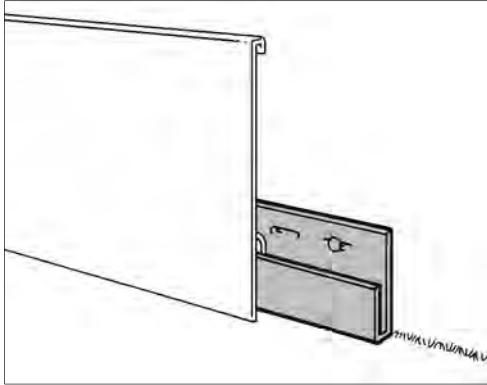

## PRODUCT INFORMATION

### Features:

- 12' vinyl clip is stapled or screw-attached to fixed walls at the floor line to permit attachment of Vinyl Base (i2140)
- Vinyl Base (i2140) ordered separately. Vinyl Base comes 2 per package so order half as much Vinyl Base as wall clip

**Note:** Measure overall length of wall run, including door and glazed openings, and round up to next 2' increment.  
Example: A 12'10" wall run rounds up to 14'  
Add up all rounded wall run lengths and divide by 12 for order quantity

Product Number	
i2812	\$30

i 2 8 1 2 .

# i2830 SYSTEMS WALLSTRIP, FIXED WALL

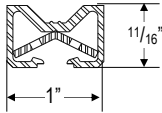
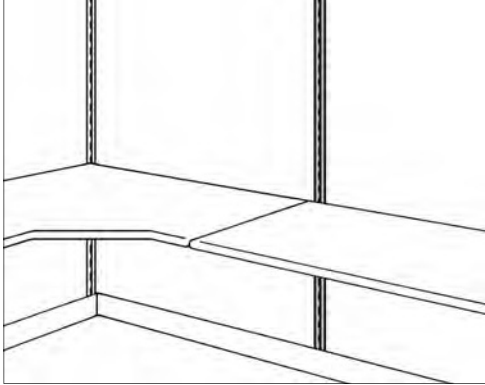

## PRODUCT INFORMATION

### Features:

- Slotted aluminum strip is attached to fixed primary or building core walls to permit hanging of systems components
- Appropriate fasteners must field supplied

### Specifiers:

- Identify ceiling height
- Identify trim finish

### Ceiling Height

108	9'	\$134
120	10'	\$142

### Trim Finish

B3B2B0	alum
9FA1A0	anodized
EDE9E0	base white
C0B7A8	desert storm
89989D	epoxy blue
4F4546	espresso
918D81	glimmer bronze
48494D	graphite
F3FDFF	ice white
323836	matte slate
B8AEA3	metallic stone
40403F	midnight black
201920	onyx
605746	rust bronze
636D6F	space grey
EAEBE6	stone white
A49E9E	warm grey

i 2 8 3 0 .

# ACCESSORIES



# i2910 TOUCH-UP SPRAY PAINT

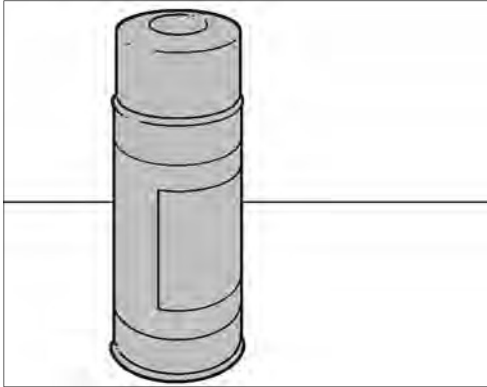

## PRODUCT INFORMATION

### Features:

- Matches powder-coated trim finishes
- All spray cans are 13 ounces

### Specifiers:

- Identify paint color

Product Number	Color
i2910 \$92	<b>AN</b> clear anodized <b>AW</b> apollo white <b>BA</b> black arch <b>BD</b> bonded aluminum <b>BM</b> black matte <b>BU</b> black undertone <b>CG</b> cosmic gray <b>CH</b> metallic champagne <b>DB</b> dark bronze <b>GS</b> grey storm <b>KH</b> khaki <b>MB</b> medium bronze <b>MC</b> mocha <b>PW</b> powder white <b>SB</b> steel blue <b>SL</b> slate <b>SW</b> snow white

i 2 9 1 0 .

# i2920 WALLCOVERING

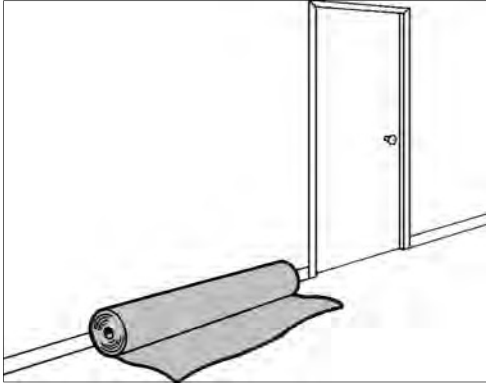

## PRODUCT INFORMATION

### Features:

- Allows fixed walls to match Movable wall panels
- Vinyl is 54" wide with 30 yards to the bolt.
- Class A or Type 1 flame-spread rated
- Use standard commercial grade wallcovering adhesive

### Specifiers:

- Identify surface finish  
See appendix for vinyl styles and colors

<b>Product Number</b>	<b>Surface Finish</b> First 2 digits specify series, last 2 specify color
i2920      \$708	AD__    adobe vinyl      +\$0

i | 2 | 9 | 2 | 0 | . |

| | | |

# i2930 WOOD DOWEL

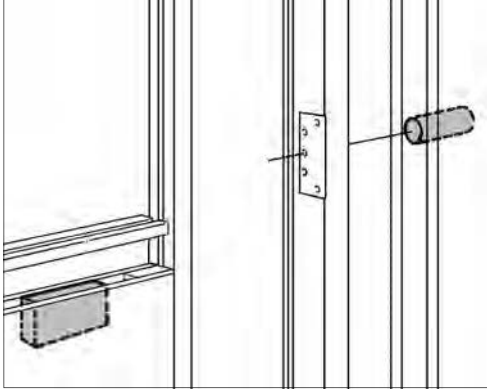

## PRODUCT INFORMATION

### Features:

- Hardwood blocks provide a seat for screws when installing door jambs into cut panels or open core areas and when installing a fixed height glazing sill in a partial-height glass application
- Allow 1 piece for each hinge and 2 pieces per strike plate for door jamb attachment
- Allow 1 square block for each panel when attaching fixed height glazing sill to partial height panel

### Specifiers:

- Identify product number  
Specify round dowels "R" when installing door frame jambs in opening cut through solid gypsum portion of panel  
Specify square blocks "S" when installing door frame jambs in opening cut through open core of panel
- Specify package

Product Number			Package	
i2930.R	round	\$44	A	12 pieces
i2930.S	square	\$44	B	bulk (100) +\$216

i 2 9 3 0 .

- i2950 DOOR FRAME PLATE - HINGE TONG**
- i2951 DOOR FRAME PLATE - HINGE FLAT**
- i2952 DOOR FRAME PLATE - STRIKE TONG**

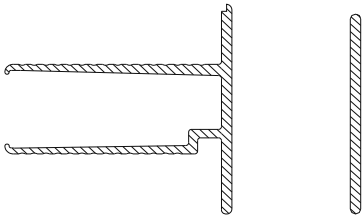
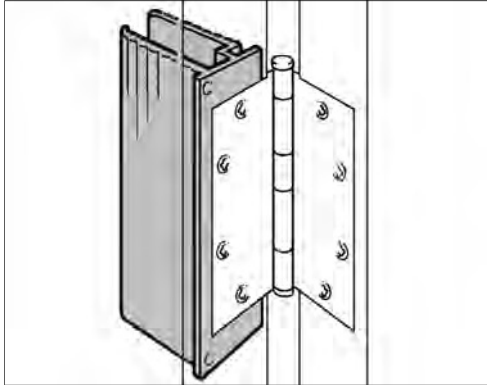

**PRODUCT INFORMATION**

**Features:**

- Used to field change frames for hinge attachment
- Tong Plates come 40 per package  
Flat Plates come 32 per package
- Hinge reinforcement plates come drilled and tapped to receive industry standard 4½" x 4" or 4½" x 4½" hinges

**Specifiers:**

- Identify product number  
Specify **i2950** for hinge-side jamb installment anchors or hinge attachment and reinforcement plates for gypsum panel installation condition  
Specify **i2951** for hinge attachment and reinforcement plates for installation next to modular intersections or glazing units  
Specify **i2952** for strike-side jamb installation anchors for gypsum panel installation conditions

Product Number		
<b>i2950</b>	hinge reinforcement tong plate	\$713
<b>i2951</b>	hinge reinforcement flat plate	\$343
<b>i2952</b>	strike installation tong plate	\$656

i | 2 | 9 | 5 | . |

# i2960 TILE ADAPTER BRACKETS

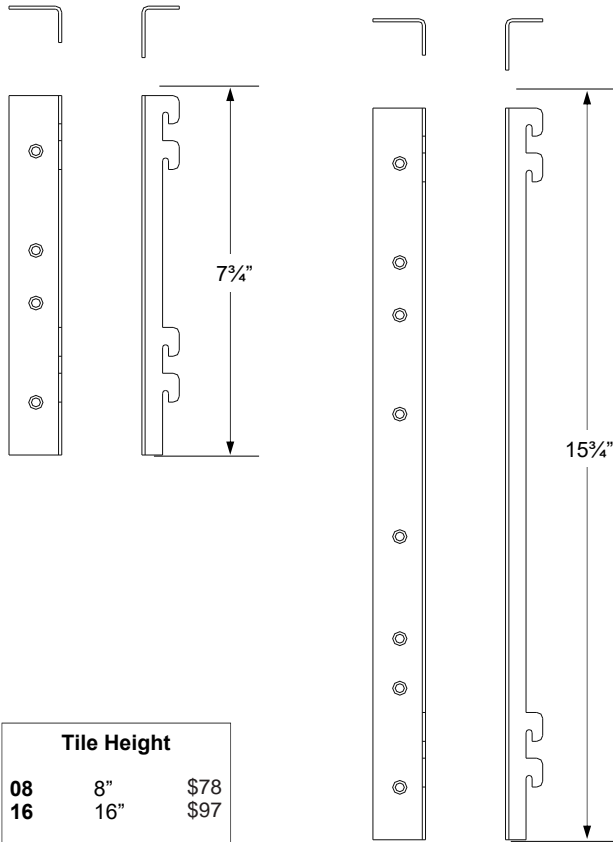

## PRODUCT INFORMATION

### Features:

- Allows 8" or 16" Systems Tiles to be surface mounted on Movable wall panels.
- Installer removes clips from Systems tile, screw attaches brackets through pre-drilled holes, then mounts Systems tile on wallstrips
- Comes in pairs

### Specifiers:

- Specify Systems tile height

Tile Height		
08	8"	\$78
16	16"	\$97

i 2 9 6 0 . | | | | |

# APPENDIX

# MODULAR PANEL FRAME WORKSHEET FOR i2275, i2276, i2277 & i2278

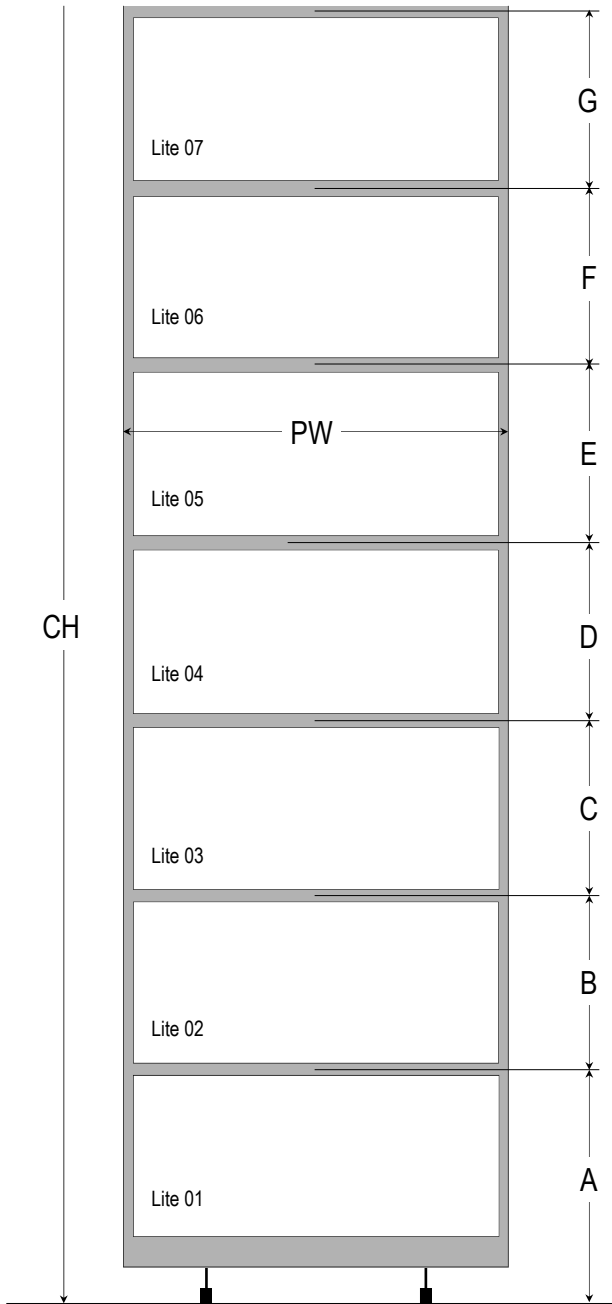

## SPECIFIERS

- Product Number** (check one)  
 i2275(1/4") or  i2277(3/8 or 1/2") Modular Panel Frame  
 i2276(1/4") or  i2278(3/8 or 1/2") Modular Panel Frame, Systems
- Ceiling Height** CH = \_\_\_\_\_ " **Panel Width** PW = \_\_\_\_\_ "
- Trim Finish** (circle one) **AN BU HF HH HT LT LU MT WB**  
 (\*Extended Lead Time) **SG SW EH CN \*MK**
- Number of Horizontal Muntins:** \_\_\_\_\_
- Muntin Height & Location (6" minimum height)**  
**Total planning dimension height is 2" less than ceiling height due to top rail of panel and ceiling runner**  
 Muntin A = \_\_\_\_\_ " (Floor to centerline of 1" muntin. Lite height will be 4 or 6" less than A height due to base trim at floor)  
 Muntin B = \_\_\_\_\_ "                      Muntin G = \_\_\_\_\_ "  
 Muntin C = \_\_\_\_\_ "                      Not Shown:  
 Muntin D = \_\_\_\_\_ "                      Muntin H = \_\_\_\_\_ "  
 Muntin E = \_\_\_\_\_ "                      Muntin I = \_\_\_\_\_ "  
 Muntin F = \_\_\_\_\_ "                      Muntin J = \_\_\_\_\_ "
- Base Height** (circle one) **0" 4" 6"**
- Lite Fillers** (refer to product pages for dimension & finish specifiers):  
 Glass Insert i2282 & i2286  
 Hard / Hard Surface Insert i2283 & i2287  
 Hard / Tack Surface Insert i2284 & i2288  
 Hard / Tack Surface Insert i2285 & i2289  
 Hard / Hard Surface Outsert i2291 & i2296  
 Hard / Tack Surface Outsert i2292 & i2297  
 Hard / Tack Surface Outsert i2293 & i2298

	Product Number	Ht	Wth	Finish (2 or 8 characters)
Lite 01:	i 2 2	.		
Lite 02:	i 2 2	.		
Lite 03:	i 2 2	.		
Lite 04:	i 2 2	.		
Lite 05:	i 2 2	.		
Lite 06:	i 2 2	.		
Lite 07:	i 2 2	.		
Lite 08:	i 2 2	.		
Lite 09:	i 2 2	.		
Lite 10:	i 2 2	.		

**NOTE:** Customer-provided glass must meet manufacturing requirements. Forward this document to Inscape for glass exact dimensions.

**FOR INSCAPE USE ONLY**

Glass size must be:

Height = \_\_\_\_\_ "

Width = \_\_\_\_\_ "

Thickness = \_\_\_\_\_ "

- Quantity of panels** = \_\_\_\_\_
- Project or Order Reference # & Name**  
 \_\_\_\_\_  
 \_\_\_\_\_

# CUSTOM TRANSOM CLERESTORY MULTI-LITE WORKSHEET FOR i2281

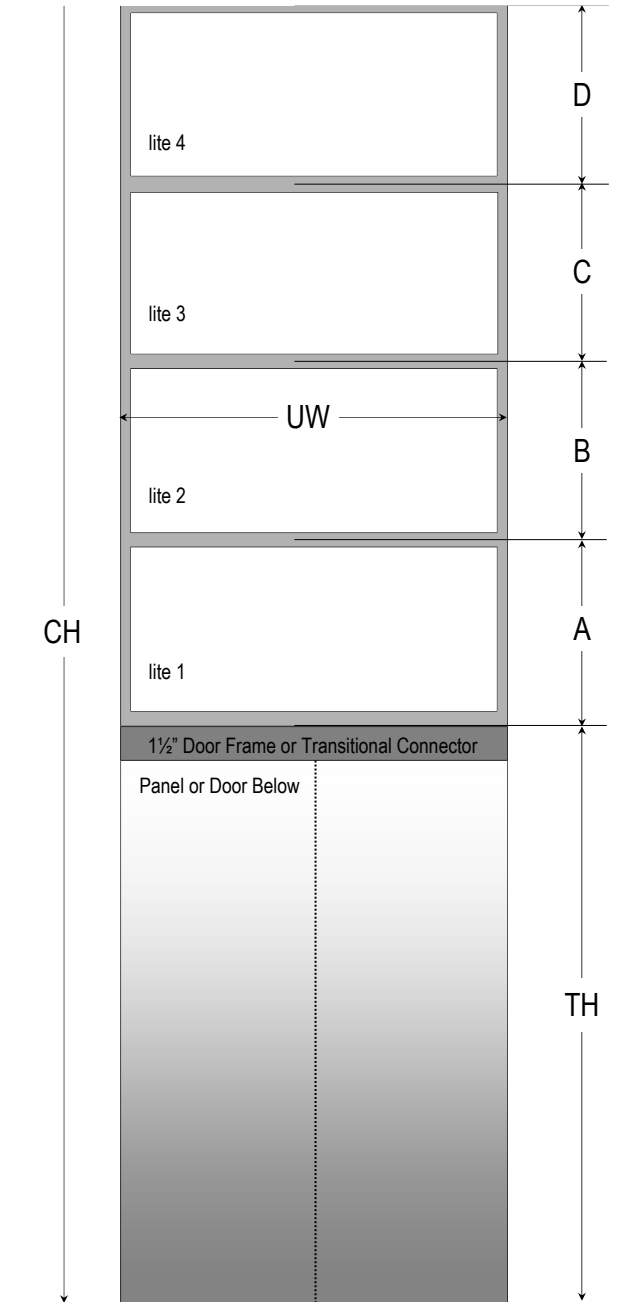

## SPECIFIERS

This completed sheet must accompany all Transom Clerestory Multi-lite orders designated "GX" Glass Finish. Fill in all requested measurements and verify trim and glass finishes

- 1) **Ceiling Height** CH = \_\_\_\_\_"
- 2) **Multi-Lite Unit Width** UW = \_\_\_\_\_"  
Note: i2281 may be wider than the panel or door below it.  
 (i.e. One 48" transom clerestory unit above two 24" gypsum panels)
- 3) **Trim Finish** (circle one) AN BU HF HH HT LT LU MT WB  
 (\*Extended Lead Time) SG SW EH CN \*MK
- 4) **Transition height** (from floor to top of transition connector)  
 TH = \_\_\_\_\_"
- 5) **Muntin Location & Lite Height (6" minimum)**  
 A = \_\_\_\_\_" (transition to centerline of 1" muntin)  
 B = \_\_\_\_\_"  
 C = \_\_\_\_\_"  
 D = \_\_\_\_\_"
- 6) **Lite Finish** (circle one for each lite)
 

lite 1 =	GX	GR	GP	GS	GG	GL
lite 2 =	GX	GR	GP	GS	GG	GL
lite 3 =	GX	GR	GP	GS	GG	GL
lite 4 =	GX	GR	GP	GS	GG	GL

7) **Quantity of panels** = \_\_\_\_\_

8) **Project or Order Reference # & Name**

\_\_\_\_\_

\_\_\_\_\_

9) **Special Requirements / Comments:**

\_\_\_\_\_

\_\_\_\_\_

\_\_\_\_\_

\_\_\_\_\_

**NOTE:** Customer-provided glass must meet manufacturing requirements. Forward this document to Inscape for glass exact dimensions.

### FOR INSCAPE USE ONLY

Glass size must be:

Height = \_\_\_\_\_"

Width = \_\_\_\_\_"

Thickness = \_\_\_\_\_"



# WRAPPED ALUMINUM FRAME AND MULTI-LITE PANEL WORKSHEET

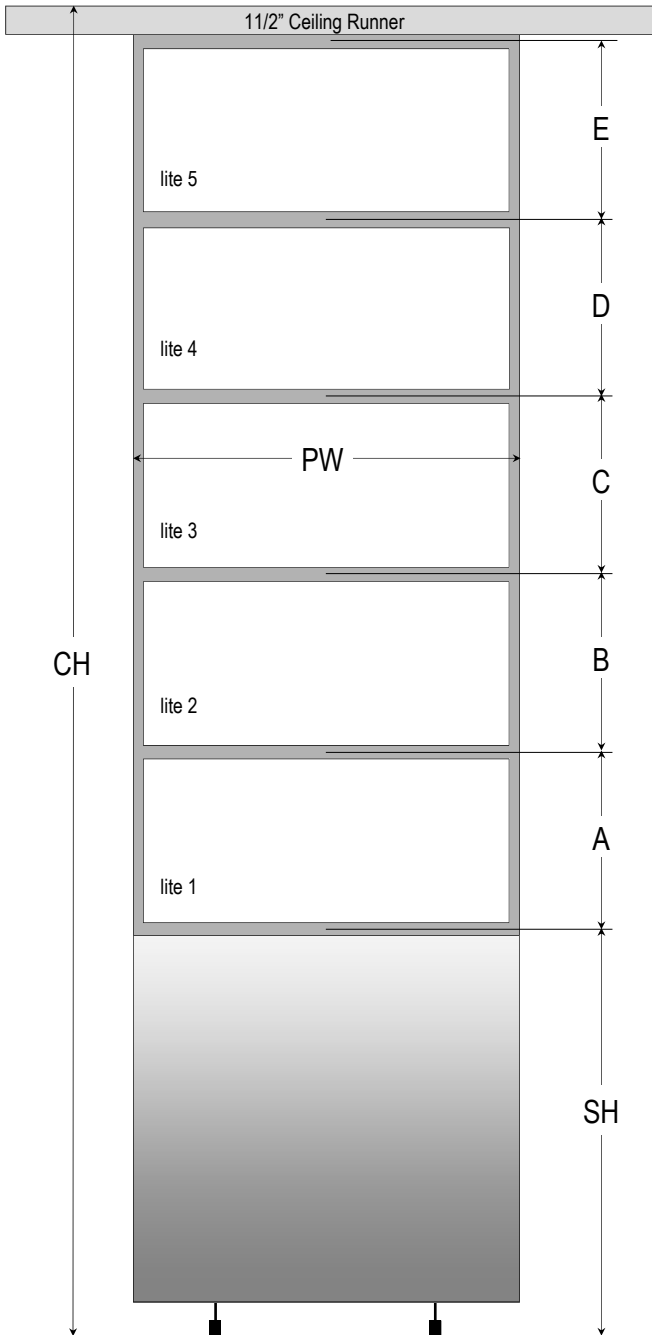

## SPECIFIERS

- Product Number** (check one)
  - i5141 Hard Surface & Multi-Lite Panel
  - i5241 Systems Hard Surface & Multi-Lite Panel
  - i5143 Tack Surface & Multi-Lite Panel
  - i5243 Systems Tack Surface & Multi-Lite Panel
  - i5145 Hard / Tack Surface & Multi-Lite Panel
  - i5245 Systems Hard / Tack & Multi-Lite Panel
- Ceiling Height** CH = \_\_\_\_\_"  
**Panel Width** PW = \_\_\_\_\_"
- Sill Height** SH = \_\_\_\_\_" (floor to centerline of 1" sill)
- Muntin Height & Location** (6" minimum height)  
**Total planning dimension height is 2" less than ceiling height due to top rail of panel and ceiling runner**
  - Muntin A** = \_\_\_\_\_" (Centerline to centerline of 1" muntin.)
  - Muntin B** = \_\_\_\_\_"
  - Muntin C** = \_\_\_\_\_"
  - Muntin D** = \_\_\_\_\_"
  - Muntin E** = \_\_\_\_\_"
  - Muntin F** = \_\_\_\_\_"
- Lite Finish** (circle one for each lite)
 

lite 1 =	GX	GR	GP	GS	GG	GL
lite 2 =	GX	GR	GP	GS	GG	GL
lite 3 =	GX	GR	GP	GS	GG	GL
lite 4 =	GX	GR	GP	GS	GG	GL
lite 5 =	GX	GR	GP	GS	GG	GL
- Trim Finish** (circle one) AN BU HF HH HT LT LU MT WB  
 (\*Extended Lead Time) SG SW EH CN \*MK
- Base Height** (circle one) 0" 4" 6"
- Solid Surface Finish**

--	--	--	--	--	--	--	--
- Quantity of panels** =            Side 1                 Side 2
- Project or Order Reference # & Name**  
 \_\_\_\_\_  
 \_\_\_\_\_

**NOTE:** Customer-provided glass must meet manufacturing requirements. Forward this document to Inscape for glass exact dimensions.

### FOR INSCAPE USE ONLY

Glass size must be:

Height = \_\_\_\_\_"  
 Width = \_\_\_\_\_"  
 Thickness = \_\_\_\_\_"

# JAMB SHEET i2500 SERIES

## i2503, i2504, i2510, i2511 Full-Height Frames

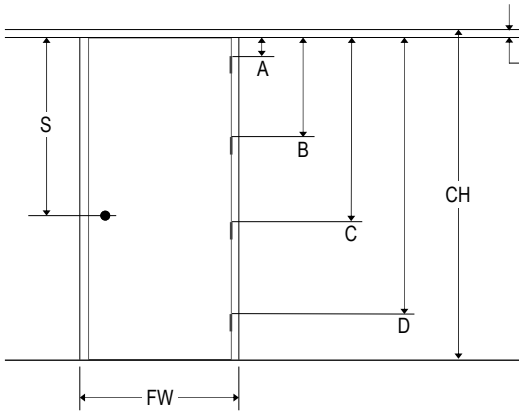

## i2512, i2513 Transom Frames

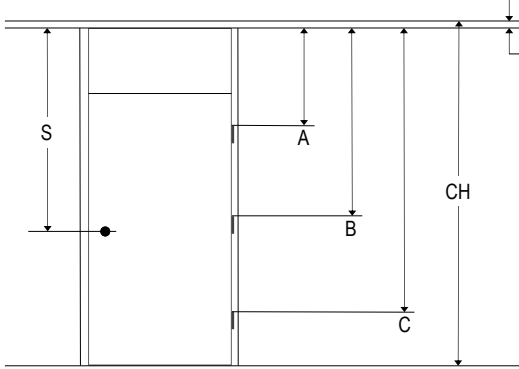

## i2505, i2506 Modular Frames i2514, i2515 Partial Height Frames

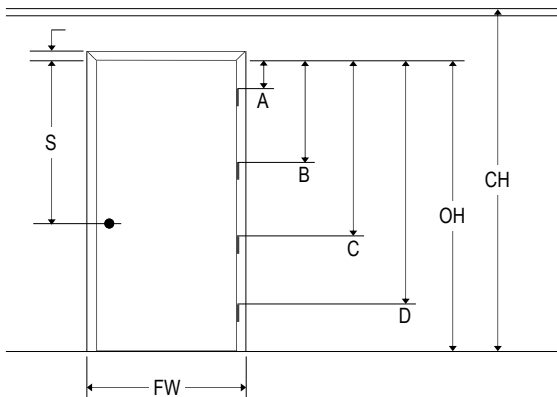

## SPECIFIERS

This completed sheet must accompany all non-standard location of strike plate or hinges.

- 1) Door Sheet # \_\_\_\_\_ of \_\_\_\_\_
- 2) Product Number (check one)
  - \_\_\_\_\_ i2503 Full Height Modular Door Frame
  - \_\_\_\_\_ i2504 Full Height Modular Double Door Frame
  - \_\_\_\_\_ i2505 Modular Door Frame with Glass
  - \_\_\_\_\_ i2506 Modular Double Door Frame with Glass
  - \_\_\_\_\_ i2510 Full Height Door Frame
  - \_\_\_\_\_ i2511 Full Height Double Door Frame
  - \_\_\_\_\_ i2512 Transom Door Frame
  - \_\_\_\_\_ i2513 Transom Double Door Frame
  - \_\_\_\_\_ i2514 Partial Height Door Frame
  - \_\_\_\_\_ i2515 Partial Height Double Door Frame
- 3) Ceiling Height: CH = \_\_\_\_\_ "
- 4) Frame Width (i2503, i2504, i2505, i2506 only): FW = \_\_\_\_\_ "
- 5) Opening Height (i2514, i2515 only): OH = \_\_\_\_\_ "
- 6) Quantity: LH \_\_\_\_\_ RH \_\_\_\_\_
- 7) Strike Plate Location: S = \_\_\_\_\_ "
- 8) Strike Plate Size: (circle one)      4 7/8"      2 3/4"      Blank
- 9) Hinge Location:
  - A = \_\_\_\_\_ "
  - B = \_\_\_\_\_ "
  - C = \_\_\_\_\_ "
  - D = \_\_\_\_\_ " (for doors over 8'0" only)

- 10) Mounting Hardware (choose one for each side)
  - Strike side: Tong \_\_\_\_\_ Flat Plate \_\_\_\_\_
  - Hinge side: Tong \_\_\_\_\_ Flat Plate \_\_\_\_\_

12) Project or Order Reference # & Name  
 \_\_\_\_\_  
 \_\_\_\_\_

13) Special Requirements / Comments  
 \_\_\_\_\_  
 \_\_\_\_\_  
 \_\_\_\_\_

<b>FOR INSCAPE USE ONLY</b>	
Hinge Gauge #	_____
Order #	_____
Ship Date	_____
Week Ending	_____

# JAMB SHEET i2570 SERIES

## i2570 Modular 42" Full Height Door Frame w/ Chase

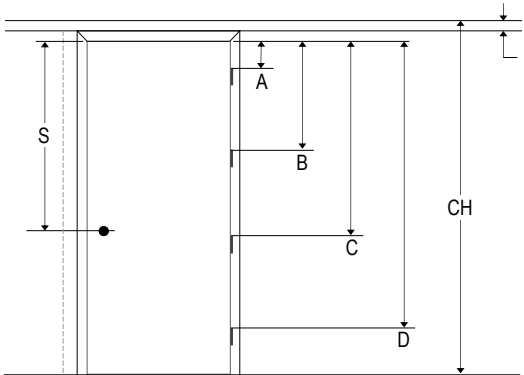

## i2571 Modular 42" Transom Door Frame w/ Chase

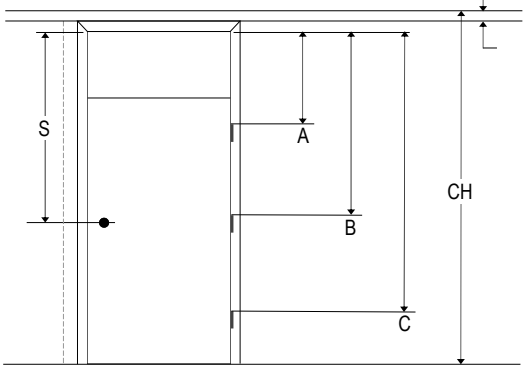

- i2572 Modular 39.5" Door Frame Panel, Hard Surface
- i2573 Modular 48" Door Frame Panel, Glass
- i2574 Modular 48" Door Frame Panel, Multi-Lite
- i2575 Modular 48" Door Frame Panel, Sidelight
- i2576 Modular 48" Door Frame Panel, Glass Transom

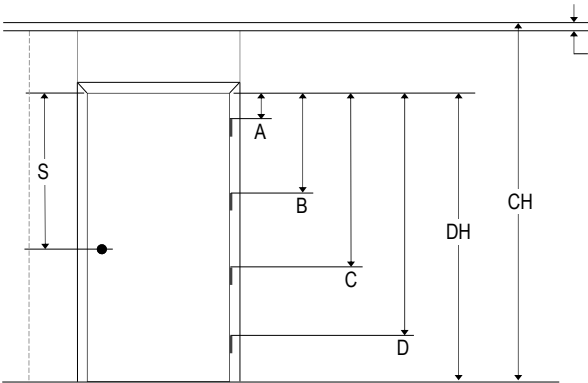

## SPECIFIERS

This completed sheet must accompany all non-standard location of strike plate or hinges.

- 1) Jamb Sheet # \_\_\_\_\_ of \_\_\_\_\_
- 2) Product Number:  
i25 \_\_\_\_
- 3) Ceiling Height: CH = \_\_\_\_\_"
- 4) Door Height (i5504, i5505, i5506, i5507, i5508, i5515 only):  
DH = \_\_\_\_\_"
- 5) Quantity: LH \_\_\_\_\_ RH \_\_\_\_\_
- 6) Strike Plate Location: S = \_\_\_\_\_"
- 7) Strike Plate Size: (circle one) 4 7/8" 2 3/4" Blank
- 8) Hinge Location:  
A = \_\_\_\_\_"  
B = \_\_\_\_\_"  
C = \_\_\_\_\_"  
D = \_\_\_\_\_" (doors over 8'0" only)

### 9) Project or Order Reference # & Name

---



---

### 10) Special Requirements / Comments \_\_\_\_\_

---



---



---

### FOR INSCAPE USE ONLY

Hinge Gauge # \_\_\_\_\_  
 Order # \_\_\_\_\_  
 Ship Date \_\_\_\_\_  
 Week Ending \_\_\_\_\_

# HINGED DOOR WORKSHEET

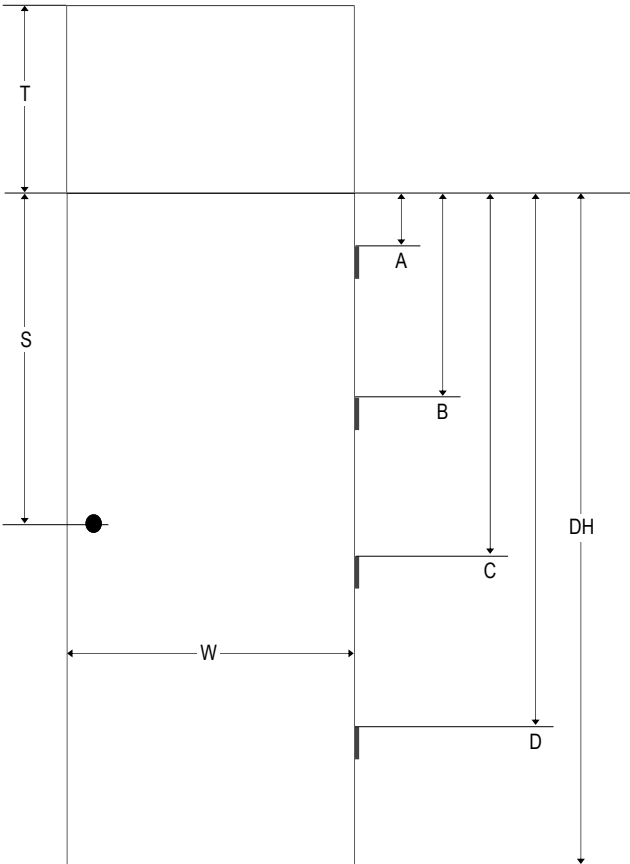
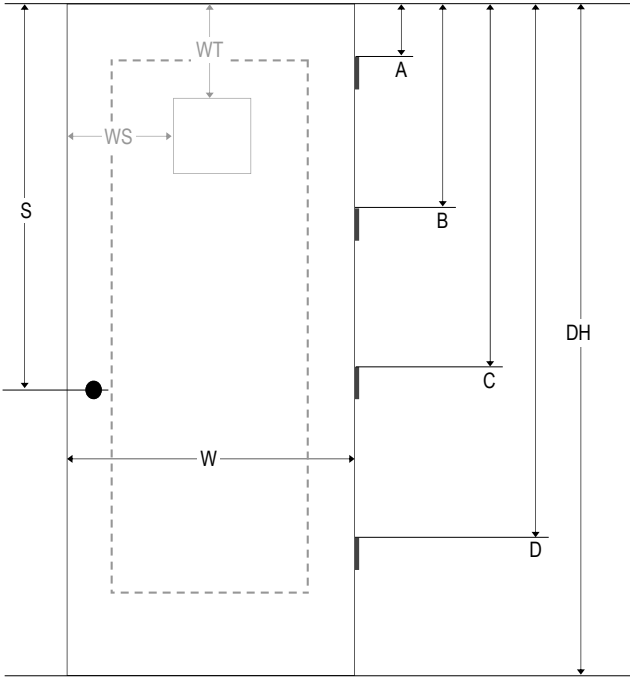

## SPECIFIERS

This completed sheet must accompany all doors with height specified as "7X", "8X", "9X" or "10X" and/or non-standard location of strike plate or hinges.

- 1) Door Sheet # \_\_\_\_\_ of \_\_\_\_\_
- 2) Product Number (check one)
  - \_\_\_\_\_ i 2520 Wood Door, Swinging
  - \_\_\_\_\_ i 2520 Wood Door, Swinging with View Window
  - \_\_\_\_\_ i 2522 Wood Door, Swinging & Matching Transom
  - \_\_\_\_\_ i 2525 Aluminum & Glass Door, Swinging
- 3) Quantity: LH \_\_\_\_\_ RH \_\_\_\_\_
- 4) Door Height: DH = \_\_\_\_\_ "
- 5) Door Width: W = \_\_\_\_\_ "
- 6) Transom Height (i 2522 only) = \_\_\_\_\_ "
- 7) Strike Plate Location: S = \_\_\_\_\_ "
- 8) Strike Plate Size: (circle one)    4 7/8"    2 3/4"    Blank
- 9) Hinge Location:
  - A = \_\_\_\_\_ "                      C = \_\_\_\_\_ "
  - B = \_\_\_\_\_ "                      D = \_\_\_\_\_ " (doors over 7'0" only)
- 10) View Window
  - Circle One:    W5    W6    W7    W8    W9
  - Location: WT \_\_\_\_\_ "    WS \_\_\_\_\_ "
- 11) Project or Order Reference # & Name
 

\_\_\_\_\_

\_\_\_\_\_
- 11) Special Requirements / Comments
 

\_\_\_\_\_

\_\_\_\_\_

\_\_\_\_\_

# ALUMINUM & GLASS SLIDING DOOR: WORKSHEET FOR i2535 & i2536

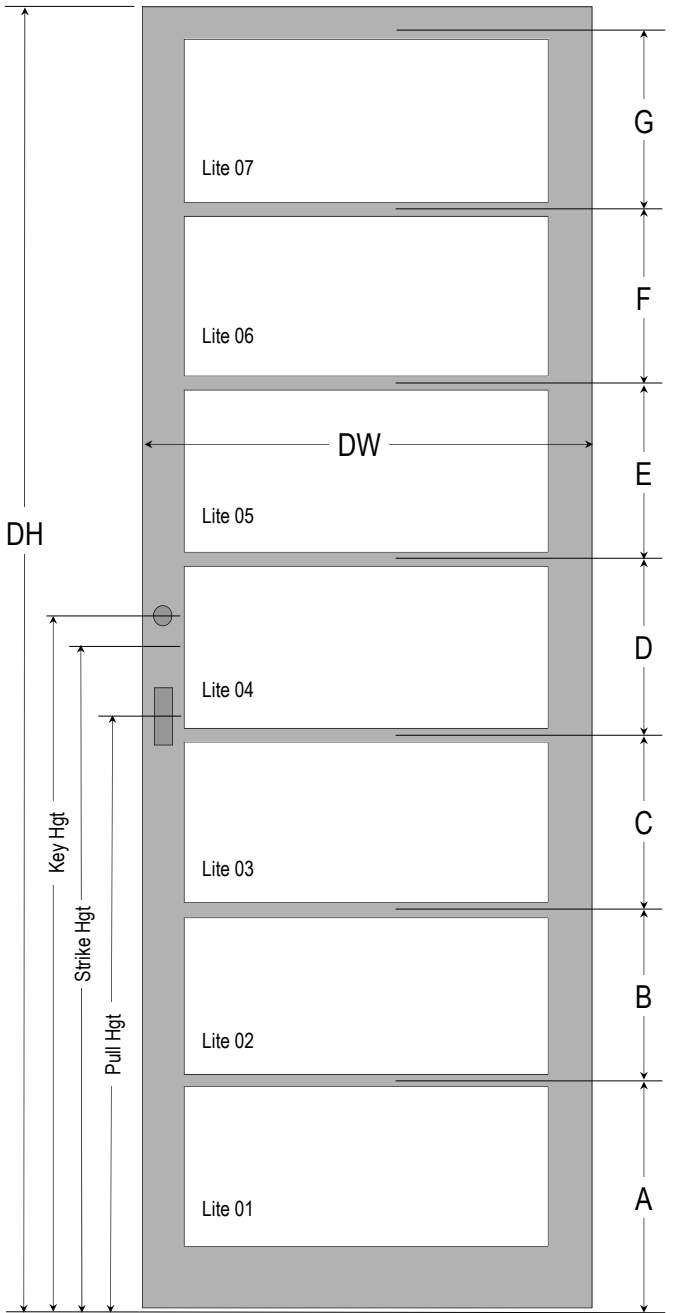

**NOTE:** Customer-provided glass must meet manufacturing requirements. Forward this document to Inscape for glass exact dimensions.

**FOR INSCAPE USE ONLY**

Glass size must be:

Height = \_\_\_\_\_"

Width = \_\_\_\_\_"

Thickness = \_\_\_\_\_"

## SPECIFIERS

This completed sheet must accompany all i 2536 doors

1) Door Height DH = \_\_\_\_\_' \_\_\_\_\_" Door Width DW = \_\_\_\_\_"

2) Optional (to centerline)  
Key Height = \_\_\_\_\_" Strike Height = \_\_\_\_\_" Cup Pull Height = \_\_\_\_\_"

3) Frame Dimensions / Slide Direction to Close (select one)  
Reference product page for dimensions

_____ 1L	_____ 1R	_____ 2L	_____ 2R
_____ 3L	_____ 3R	_____ 4L	_____ 4R
_____ 5L	_____ 5R	_____ 6L	_____ 6R
_____ 7L	_____ 7R	_____ 8L	_____ 8R
_____ 9L	_____ 9R	_____ 10L	_____ 10R

4) Number of Horizontal Muntins: \_\_\_\_\_

5) Muntin Height & Location (6" minimum height)

Total planning dimension height is 2" less than ceiling height due to top rail of panel and ceiling runner

Muntin A = \_\_\_\_\_" (Floor to centerline of 1" muntin. Lite height will be 4 or 6" less than A height due to base trim at floor)

Muntin B = _____"	Muntin G = _____"
Muntin C = _____"	Not Shown: _____"
Muntin D = _____"	Muntin H = _____"
Muntin E = _____"	Muntin I = _____"
Muntin F = _____"	Muntin J = _____"

6) Trim Finish (circle one) AN BU HF HH HT LT LU MT WB  
(\*Extended Lead Time) SG SW EH CN \*MK

7) Machining / Lockset (circle one)

NA	M1	M2	M3	M4	M5	M6	M7	MC*
----	----	----	----	----	----	----	----	-----

\*provide drawing with special cutouts needed

8) Glass Inserts (refer to i 2282 page for dimension & finish specifiers):

	Product Number	Ht	Wth	Finish
Lite 01:	i 2 2 8 2 .			
Lite 02:	i 2 2 8 2 .			
Lite 03:	i 2 2 8 2 .			
Lite 04:	i 2 2 8 2 .			
Lite 05:	i 2 2 8 2 .			
Lite 06:	i 2 2 8 2 .			
Lite 07:	i 2 2 8 2 .			
Lite 08:	i 2 2 8 2 .			
Lite 09:	i 2 2 8 2 .			
Lite 10:	i 2 2 8 2 .			

8) Quantity of doors = \_\_\_\_\_

9) Project or Order Reference # & Name

---

## VINYL, FABRICS, VENEERS & FACTORY APPLIED WINDOW FILM

### **Adobe Vinyl**

54" wide  
100% backed vinyl

<b>8301</b>	Off White
<b>8303</b>	Inner Tone Light Light
<b>8304</b>	Inner Tone Light
<b>8306</b>	Sand Light Light
<b>8309</b>	China
<b>8315</b>	White
<b>8316</b>	Soft White
<b>8317</b>	Sandstone
<b>8318</b>	Folkstone Grey

An extensive selection of vinyl wallcoverings are suitable for wall system application. Check with your sales rep for CUS submittals.

### **Veneers**

Many natural and recut veneers are available.

Most veneer finishes are available in architectural grade match.

Custom veneers can be submitted to be matched.

Veneer woodgrain runs vertical unless specified otherwise.

Multiple wood tiles in 'end match' available upon request.

Contact Inscape for CUS submittals.

### **"FX" Factory Applied Film Option**

Inscape is certified to install 3M™ window film

Standard Films Available:

All 3M™ Fasara™ Films  
3M™ ScotchCal™ Films

Please contact your sales rep for further information or to request samples.



