

US Price List

June 2021



State of New York

Contract # PC68355, Group #20915, Award #23109

Contents

Why Office Specialty?	3
Our Roots	3
Care & Maintenance	4
Transit Times	7
Finishes	9
• Paint options, locks & optional fronts	10
• Surfaces & storage fronts	11
• Paint	13
• Wood legs, glass & PET	18

Storage

General Info	20
• Statement of line	21
• Case weights/cubes	22
• COM calculator & fabric layup	23
• COM test	24
• Panel height compatibility matrix	25
• Sliding rail quantities	26
• Lock locations	27
• Counterweight matrix	30

2Stor	31
Pedestals	32

9900 Series Pedestals	33
Freestanding, Letter Width	35
Cushion Pedestals	41
Individually Locking Drawers	42

9900 Series Laterals	43
Pre-configured	45
• 2 high	45
• 3 high	47
• 4 high	48
• 5 high	51
• 6 high	54
• 7 high	58
• 8 high	59
• Individually Locking	60
• Secure Files	62
• Lateral-Peds	63
• Fusion	64
• Multi-units	65
• Mailroom Units with SuperStor™ Insert	68
• Overfile Sliding Door Cabinets	70
• Storage and Wardrobe Cabinets	73
• Storage Cabinet with SuperStor™ Insert	79

Verticals	81
------------------	-----------

Build-Ups	84
Basic Lateral Cabinets	86
Basic Lateral Cabinets with Security Lock Bar	89
Cabinet Interiors	90
• Drawer and Shelf Interiors	90
• Hinged Door Cabinet Inserts	99
• SuperStor™ Inserts	100
• Bookcase Inserts	102

Towers	104
Modular Towers	105
• Base Modules	106
• Base Modules with MoPed	108
• Stack Modules	109
• Slimline Towers	110
• Multi-Use	111

Bookcases & Display Cabinets	132
Bookcases	133
Display Cabinets	140
Bookcase Lateral Combinations	141

Waste & Recycle Bins	142
---------------------------------	------------

Storage with Handles	145
Pedestals	146
• Freestanding, Letter Width	147
• Cushion Pedestals	148
Laterals	149
• Overfile and Storage Cabinets	152

Custom Profile	155
Pedestals	156
• Freestanding, Letter	157
Laterals	159
• Letter/Legal Size Media	160
• Multi-units	162
• Overfile and Storage Cabinets	163
• Storage and Wardrobe Cabinets	164

Build-Ups	167
• Basic Lateral Cabinets	167
• Cabinet Interiors	170
Shop drawings	172
• Drawer fronts for pedestals	172
• Drawer fronts for laterals	173
• Hinged drawers for multi-units	174
• Doors for hinged door cabinets	175

Nuform Shapes	178
Arrow Shape	180
River Shape	181
Bubble Shape	182

GRID	183
Pedestals	184
Laterals	186
Storage Cabinets	189
• Solid Core Doors	189
• Glazed Doors	192
Multi-Units	194
• Solid Core Doors	194
• Glazed Doors	197

Storage Accessories	206
For pedestals	208
Interior Accessories for All Laterals	210
Interior Accessories for All Laterals/Hinged Door Units	213
For all laterals	214
Lateral Tops	216
• Laminate	216
• Nuform	217
Pedestal Cushions	218
Lateral Cushions	219
Glides	220
Modular Towers	223
Verticals	225

Workstations

RockIt	228
Core and Supports	230
Electrical	234
• In-feeds	234
• Power Tracks and Jumper Cables	236
• Power Modules	237
• Receptacles	238
• Data Components	239
• Cable Management	240
Worksurfaces	242
• Rectangular with Scallop	242
• Rectangular with Cutout	243
• SkyRockIt Height Adjustable Worksurface	244
• SkyRockIt Electric Height Adjustable Worksurface	245
• Rectangular for 90° Workstations	246
Storage	248
• Cargo Storage	248
• Bunker Storage	249
• Mobile Pedestals with Cushion	250
Accessories	252
• Table-Mounted	252
• Hip-Hung	253
• Groove-Mounted Risers	254
• Groove-Mounted Trays	258
• Core Front Rail Mount	259
• Modesty Panels	260

Conditions of Sale

Refer to the Conditions of Sale document on the [Resources](#) page of [officespecialty.com](#)

Space for everything.

Why Office Specialty?

You spend a lot of time in the office, and we want to make sure you have the room to make it feel like your own space—comfortable and organized. Our approach to products is all about encouraging the well-being of everyone in a workplace environment, with solutions built to minimize clutter and foster beautiful collaborative workspaces.

Power of 1½

When office space is at a premium, every inch counts. Our case heights come in 1½ inch increments, letting you scale your storage to maximize capacity without sacrificing real estate. The 1½ inch increment is also a driving force in our workstation solutions.

Quality

Precisely crafted in North America, the exceptional quality of our products has been our focus for over 130 years. We are masters at metal work, dedicated to craftsmanship and sourcing only the finest materials to create long-lasting pieces with one simple purpose in mind—to help you create a space that you're most comfortable working in.

Adaptability

Companies grow, offices move, and workspaces are always transforming. We believe your storage solution should be able to keep up. With our modular interiors and inserts, you can retrofit cabinets with new accessories as you need them.

Customization

We want our clients to have the freedom to stay true to their design, especially if it's something completely out of the box. Along with thousands of finish options—including paint, laminate and Nuform—our team can work directly with you to build something entirely unique to fit your plan.

Crafted with care in North America.

Our Roots

Since 1888, we've been pioneers at building work space solutions to make our clients' lives easier. From our first wooden file cabinets to our latest selection of workbars and custom finishes, we've continued to proudly offer our top-quality office furniture with the highest standard of client care.

It's our specialty.

Our focus on quality doesn't stop at our products—it's built into how we care for our clients. Have a question or need help, please give us a call:

1-855-440-6446



Care & Maintenance

US Price List • June 2021



Care & Maintenance

The following information provides general guidelines for cleaning and maintaining all Office Specialty products.

Painted metal

- Clean painted metal surfaces with a soft damp cloth and warm soapy water
- Gently rub tougher grime away with a mild, non-abrasive household cleaning product
- Paint touch up kits are available for minor repairs
- **Note:** Most consumer cleaners may be used, always spot test products to ensure no hazing or softening the coated film takes place
- Mechanical parts require no lubrication or maintenance
- All parts are factory lubricated for a lifetime of superior performance

Nuform surfaces

Nuform Classic and Nuform Select surfaces are manufactured by thermoforming a polymer sheet around an MDF substrate. The polymer sheet is surface-coated with a scratch resistant film.

Nuform has a seamless edge that provides a clean aesthetic eliminating the need for an edge banding where bacteria, fungus and mold can penetrate and flourish.

- For general cleaning, use warm soapy water, a mild, non-abrasive household cleanser or a 10-20% bleach solution
- To remove stains like permanent marker use a cotton ball dampened with Acetone
- Tougher stains may be removed with methyl hydrate.
- Do not use abrasive cleaners or highly solvent based chemicals such as gasoline, acetone or toluene as they may scratch or affect the surface appearance
- Do not place hot appliances directly on Nuform surfaces
- Although Nuform is scratch resistant, avoid dragging sharp objects across the surface
- Light scratches may be buffed from the foil surface by using a 400-600 grit wet sandpaper under light hand pressure in circular motions or by using a 3M Scotch Brite Pad (green color only) under light hand pressure in circular motions.

Note: Under no circumstances should power buffing tools be used

- Chips and deep scratches may be repaired by a professional touch-up service. Minor imperfections should be addressed immediately as neglect can result in more serious problems that could void the warranty.
- Optimal storage temperature range for Nuform surfaces is 44°F to 86°F
- Avoid exposure to extreme heat, cold and humidity

Laminate surfaces

High pressure laminate is available for use on surfaces and accessories and is laminated to particleboard and includes a color coordinated edge banding.

- Dust off laminated surfaces prior to cleaning
- For general cleaning, use warm soapy water or a mild, non-abrasive household cleanser. Do not use a cleanser with acids or alkalis as this will damage the surface. Remember to wipe the surface with the grain using a dry soft cloth.
- An eraser may assist in removing ink marks
- Isopropyl alcohol or rubbing alcohol may be used to clean laminate surfaces
- Do not use abrasive cleaners or bleaching cleansers as they may scratch or affect the surface appearance
- Take note that any product with hydrochloric, sulfuric, or phosphoric acid may permanently damage the surface
- Although high pressure plastic laminates are resistant to scratching and wear, avoid dragging sharp objects across the surface
- Do not place hot appliances directly onto laminate surfaces
- Avoid exposure to extreme heat, cold or humidity

Wood

Wood is an option on the Angled Hip Leg Supports. Like all natural products, wood legs may vary slightly in grain, texture and color. For this reason, minor variations between pieces can be expected.

- Dust surface with a dry cloth in the direction of the grain
- For dirtier surfaces, use warm soapy water and a soft cloth
- Do not use abrasive cleaning products as they may scratch or affect the surface appearance.
- Although waxing and polishing is not necessary, waxing and polishing products may be applied if care is taken to avoid wax build-up which may cloud the finish
- Exposure to strong sunlight should be avoided since fading may result
- Avoid exposure to extreme heat, cold or humidity
- Avoid dragging sharp objects across the surface
- Chips and scratches may be repaired by a professional touch-up service

Fabric surfaces

- Vacuum or lightly brush fabrics to remove dirt build-up
- Promptly remove stains by blotting, not rubbing the fabric to retain pile texture
- Fabric may be cleaned with mild water-free solvents or water-based cleaning agents or foam
- Always follow the manufacturer's instructions and test clean a non-visible area first

Care & Maintenance

Glass surfaces

- Clean glass with a mild window cleaner

Acrylic surfaces

- Clean acrylic with a clean soft cloth and warm soapy water

Whiteboards/Dry Erase Boards

- Use only dry erase markers on boards
- Whiteboards are not intended for use with PERMANENT markers
- Clean boards with an eraser or microfiber cloth and cleaner that is formulated for whiteboards
- Office Specialty recommends using “Sanford Expo Dry Erase Markers” and “Sanford Whiteboard Cleaner”

Bin/shelf-mounted task light fixtures

- Include a 120v/60hz magnetic ballast. Replacements can be purchased from any electrical supply store.

PET surfaces

- PET products have been developed to be easily cleaned and maintained
- Simply remove dust and dirt with a stiff plastic bristle brush, or by vacuuming
- Distilled water can be used to remove any stains
- A 1:1 part bleach to warm water solution or a 3% hydrogen peroxide solution may be used to clean surface area
- Always use a soft, clean cloth and blot dry

Proper loading of lateral cabinets

To prevent tipping and possible injury...

1. Load cabinet starting at the bottom opening and work up.
Reverse this procedure for unloading.
2. Wherever possible place heavier materials in the lower drawers.
3. Level the cabinet using the adjustable glides. Failure to level the cabinet correctly may result in cabinet malfunction.
4. Each cabinet is equipped with a patented Safelock™ interlock mechanism which prevents more than one drawer from being opened at a time. The interlock system must be kept in proper working order to ensure user safety.
5. Cabinets may be bolted together for additional stability. Counterweights may be required for cabinets that cannot be bolted together.

Transit Times

US Price List • June 2021



Average Transit Times LTL Furniture

United States:

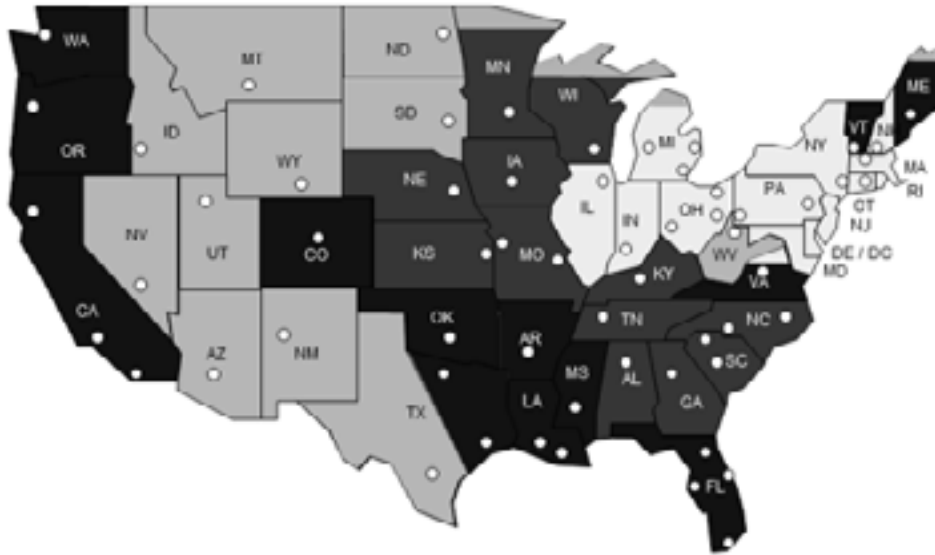

From Date of Departure:

3-5 Day Transit

NH, MA, CT, NY, RI, PA, MD, DE, DC, OH, IN, IL, MI, NJ

4-6 Day Transit

SC, GA, AL, TN, NC, MO, KS, IA, NE, MN, WI, KY

5-7 Day Transit

CO, CA, FL, OR, WA, TX, VA, VT, ME, MS, LA, AR, OK

5-8 Day Transit

WV, MT, ND, SD, ID, WY, UT, NV, AZ, NM, TX

*Date of departure may be any day in the acknowledged ship week ending.



Finishes

US Price List • June 2021

Standard colors

We love color! At Office Specialty we are not afraid of color, we embrace it.

We offer a large variety of neutral and accent colors. Find the perfect color to match your personality.

All products are finished with a two-coat electrostatic enamel that provides a high-quality, fade and chip resistant surface with a gloss level of 37.5%. Refer to our current Paint Cards or Fans for standard color selection.

All interior drawer bodies, shelves, accessories and exposed hardware are finished in EcoBlack (excluding European style hinges and locks on the Storage with Handles and 9900 Series). Standard colors include a selection of mica/metallic colors available at no upcharge which is called the Neutral Collection. In addition, Office Specialty offers the Accent Collection; a line of beautiful, bright colors at an upcharge.

Custom (non-standard) colors

Office Specialty offers colors matched to a customer's specification when possible. This matching is done through a database of over 3,000 existing color formulas or the development of a new custom color. A \$324 net fee applies for each custom color per order. In addition, Custom Premium colors (bright whites and bright colors; textured paints; and reflection paints that use mica, aluminum or special chemical to create their reflective properties) will be subject to a 10% upcharge to the net value of the product per order.

Multi-color cabinets

For multi-color cabinets where the case is one color and the drawer fronts are a second color, a \$270 net fee applies per color per order. (Tie bars and reference shelves will be painted the same color as the case.). This charge is applicable for multi-color applications using Neutral, Accent or Custom paints. If using an Accent paint on a Multi-color cabinet, the standard Accent paint upcharge for the unit will also be applicable.

Note: Multi-color cabinets are not available on Storage with Handles.

Paint finish availability matrix

	Standard colors	Textured colors	Custom (non-standard) colors
Storage with Handles	○		
9900 Series	○	○	○
GRID	○	○	○
Custom Profile Series	○	○	○
Bookcase /Display Cabinets	○	○	○
RockIt	○	○	○

Available Unavailable

Lock finishes

Locks are available in Bright Chrome, Satin Chrome or Black finishes only. Specify a finish.

Lock finish availability matrix

	Default	Optional	Optional
Storage with Handles	BC	BL	SC
9900 Series	BC	BL	SC
Custom Profile	BL	BC	SC
GRID - Wenge	BL	BC	SC
GRID - Cherry/Maple	SC	BL	BC
GRID - Woodgrain/Patterns	SC	BL	BC

BL Black	BC Bright Chrome	SC Satin Chrome
--------------------	----------------------------	---------------------------

Custom profile

Custom Profile lateral, pedestal and hinged door cabinets are complete assembled units without fronts. Specifiers may design their own cabinet fronts using a variety of materials.

Refer to the [Custom Profile section](#) for a selection of basic cabinets and preconfigured cabinets. Detailed shop drawings depicting drawer and door fabrication specifications are included in the Custom Profile section.

Office Specialty reserves the right to approve all requests for special finishes.

Nuform fronts & tops

Nuform is applied by heating the material and then bonded to MDF using a water-based adhesive.

The Nuform thermoforming technique bonds rigid thermofoil material to contoured surfaces, eliminating the seam lines associated with edge-banding and bull nosing that is characteristic of most laminates and veneers.

Its seamless edge provides a clean aesthetic with a continuous pattern and color repeat. The underside of the top is finished in a low pressure melamine.

Nuform Classic

Colorways	Product code
Sandstone	F123
Frosty White	F127
Designer White	F129
Calm Grey	F131
Pitch Black	F132
Honey Brown	F09
Espresso	F38
Swiss Elm	F40
Blonde Maple	F42
Barn Board	F43

Nuform Select

Colorways	Product code
Rustic Plank	F45
English Walnut	F46
Natural Plywood	F47
Nordic Ash	F48
Ink Thread	F49
Rose Gold Thread	F50
Copper Thread	F51
Fossil Slab	F52
Pearl Slab	F53
Stark Slab	F54
Alabaster Sandstone	F55
Aurora Marble	F56
Pure Oak	F57
Holland Hickory	F58
Essential Oak	F59

Laminate common tops

Tops are self-edged, high pressure laminate with a backing sheet over a core of high density particle board. Tops are mounted onto cabinets using double sided tape which is included. Laminate is bonded to 1" thick particleboard. The underside of the worksurface is finished with a wood-fiber veneer backer. Worksurfaces specified with a laminate finish include a 2mm edge banding in a coordinating color. Plastic laminate tops do not have optional pencil groove.

Laminate worksurfaces

Laminate is bonded to 1.25" thick particleboard. The underside of the worksurface is finished with a wood-fiber veneer backer. Worksurfaces specified with a laminate finish include a 2mm edge banding in a coordinating color. Plastic laminate tops do not have optional pencil groove.

Code legend:

- LLC = HPL with matching edge band
- LIC = HPL with matching or plywood edge band
- OCC, OIC = HPL with self edge
- MCC = LPL with matching edge band

Laminate

Colorways	Common Top Product Code	RockIt Product Code	RockIt Edge Color
Wild Cherry	OCC01	LCC01	Rustic Cherry
Maple	OCC02	LCC02	Fusion Maple
White	OCC07	LCC07	Designer White
Pumice	OCC08	LCC08	Beige
Antique White	OCC09	LCC09	Warm White
Gray	OCC12	LCC12/MCC009	Folk Stone
Madagascar	OCC14	LCC14	Madagascar
Asian Sand	OCC15	LCC15	Asian Sand
River Cherry	OCC16	LCC16	River Cherry
Wenge	OCC17	LCC17	Wenge
Elegant White	OCC19	LCC19	Frosty White
Neowalnut	OCC23	LCC23	Neowalnut
Mangalore Mango	OCC29	LCC29	Mangalore Mango
Pearwood	OCC30	LCC30	Pearwood
Black	OCC33	LCC33/MCC012	Black
Walnut Heights	OCC35	LCC35	Walnut Heights
Studio Teak	OCC36	LCC36	Studio Teak
Slate Gray	OCC41	LCC41	Slate Gray
Raven	OCC42	LCC42	Raven
Dalia	OCC43	LCC43/MCC007	Dalia
Mimosa	OCC44	LCC44/MCC008	Mimosa
Inspiration	OCC45	LCC45/MCC010	Inspiration
Nova White	OCC46	LCC46/MCC001	Designer White
Storm	OCC47	LCC47/MCC011	Storm
White Lace	OCC48	LCC48/MCC013	White Lace
Chill	OCC49	LCC49/MCC014	Chill
Haze	OCC51	LCC51/MCC016	Haze
Dover White	OCC52	LCC52	Dover White
Graphite	OCC53	LCC53	Graphite

OCC-18 and LCC-18 is available but is reserved for existing customers due to its different edge banding.

Grade 1 Laminate

Colorways	Common Top Product Code	RockIt Product Code	RockIt Edge Color
Elegant White	—	L1C001	Plywood
Black	—	L1C002	Plywood
Slate Gray	—	L1C003	Plywood
Raven	—	L1C004	Plywood
White Ash	O1C005	L1C005	White Ash
Weathered Ash	O1C006	L1C006	Weathered Ash
Finnish Oak	O1C007	L1C007	Finnish Oak
Fawn Cypress	O1C008	L1C008	Fawn Cypress

In addition, all Wilsonart with a "Matte - 60" finish, all Formica with a "Matte - 58" finish, all Nevamar with "Textured (T)" finish and all Pionite with "Suede (N)" finish are available as specials.

Grade 2 Laminate

Colorways	Common Top Product Code	RockIt Product Code	RockIt Edge Color
Natural Grain	—	L2C001	Natural Grain

The following prefixes will be referenced on order acknowledgments:

E	indicates standard paint on all filing and storage items
ET	indicates standard textured paint on all filing and storage items, a 10% upcharge is applicable to the net value of the product
EA	indicates standard accent paint on all filing and storage items
P	indicates standard paint on all other items
PT	indicates standard textured paint on all other items, a 10% upcharge is applicable to the net value of the product
PA	indicates standard accent paint on all other items

Neutral paint collection

Textured colors

- Available Unavailable

Note: A 10% upcharge is applicable to the net value of the product for textured colors.

Name	Color code	Textured colors
Bisque	004	<input type="radio"/>
Chinook	010	<input type="radio"/>
Onyx	013	<input type="radio"/>
Frost	022	<input type="radio"/>
Arctic	023	<input type="radio"/>
Champagne	024	<input type="radio"/>
Titanium	052	<input type="radio"/>
Mushroom	055	<input type="radio"/>
Krypton Reflections	063	<input type="radio"/>
Cinder Reflections	066	<input type="radio"/>
Soapstone	112	<input type="radio"/>
Warm White	121	<input type="radio"/>
Mist	122	<input type="radio"/>
Sandstone	123	<input type="radio"/>
Light Taupe	124	<input type="radio"/>
Medium Gray	126	<input type="radio"/>
Nickel Reflections	127	<input type="radio"/>
Slate Reflections	128	<input type="radio"/>
Quartz	160	<input type="radio"/>
Glacier White	168	<input type="radio"/>
Charcoal Gray	205	<input type="radio"/>
Pebble Gray	217	<input type="radio"/>
Deep White	223	<input type="radio"/>
Mocha	255	<input type="radio"/>
Latte	274	<input type="radio"/>
Juniper Reflections	281	<input type="radio"/>
Quicksilver Reflections	282	<input type="radio"/>
Sunstone Reflections	284	<input type="radio"/>
Aluminum Leaf	290	<input type="radio"/>
Sasha	300	<input type="radio"/>
Elson	301	<input type="radio"/>
Shade	302	<input type="radio"/>
Anonymous	303	<input type="radio"/>
Urban	304	<input type="radio"/>
Dorian	305	<input type="radio"/>
Dover	306	<input type="radio"/>
Jubilee	307	<input type="radio"/>
Softer Tan	308	<input type="radio"/>

Name	Color code	Textured colors
Storm Cloud	309	<input type="radio"/>
Rice Grain	310	<input type="radio"/>
Ramie	311	<input type="radio"/>
Favorite Tan	312	<input type="radio"/>
High Tea	314	<input type="radio"/>
Stone Reflections	315	<input type="radio"/>
Dovetail Reflections	316	<input type="radio"/>
Yorkshire	317	<input type="radio"/>
Coriander	318	<input type="radio"/>
Snowcap	319	<input type="radio"/>
Salem	320	<input type="radio"/>
Burnt Sierra	321	<input type="radio"/>
Drizzle	322	<input type="radio"/>
Scroll	323	<input type="radio"/>
Cumin	324	<input type="radio"/>
Seagull	325	<input type="radio"/>
Smoke	326	<input type="radio"/>
Gunpowder Blue	327	<input type="radio"/>
Starlight Silver	329	<input type="radio"/>
Martini Reflections	330	<input type="radio"/>
Laminate White	332	<input type="radio"/>
Steel Wool	334	<input type="radio"/>
Kettle Black	335	<input type="radio"/>
White Velvet	336	<input type="radio"/>
Simply White	337	<input type="radio"/>
Dark Bronze **	338	<input type="radio"/>

**Due to the semi-transparent nature of clear coat paint finish, the substrate material, as well as markings from the manufacturing process may be visible through the finish. For warranty information, please refer to the North American warranty on officespecialty.com.

**338 Dark Bronze is not recommend for use on the Stacker Launch Pad. Please select any of the other Inscape standard paint colors. If 338 Dark Bronze must be specified, a waiver must be signed and returned. Please contact your regional Sales Resource Team member for details.

Accent paint collection

Standard colors are prefixed with a 'A'.

Name	Color code	Name	Color code
Peony	A339	Hummingbird	A358
Lilac	A340	Spring	A359
Amethyst	A341	Marimo	A360
Mulberry	A342	Fern	A361
Plum	A343	Azure	A362
Citrine	A344	Wave	A363
Canary	A345	Lapis Blue	A364
Lotus	A346	Atoll	A365
Monarch	A347	Papillon	A366
Coral	A348	Lagoon	A367
Amaryllis	A349	Night Sky	A368
Apricot	A350	Aqua	A369
Cantaloupe	A351	Inscape Teal	A370
Poppy	A352		
Caliche	A353		
Obsidian	A354		
Dahlia	A355		
Honeydew	A356		
Sage	A357		

Grade A

Open House

Pattern	Product code
Green Apple	U1400
Red Delicious	U1401
Onyx	U1402
Slate	U1403
Amber	U1404
Willow	U1405
Straw	U1406
Angora	U1407
Green Olive	U1412
Goose	U1413
Cumin	U1414
Deep Water	U1415
Quarry Blue	U1416
Midnight	U1417
Sunshine	U1419
Asteroid	U1421
Coffee Bean	U1425
Geranium	U1426
Thistle	U1427
Fossil	U1431
Lapis	U1432
Vanilla	U1434
Pumpkin	U1435
Wolf	U1436
Birch	UC2086
Eucalypt	UC2088
Graphite	UC2090
Cobalt	UC2091
Mulberry	UC2092
Pineneedle	UC2095
Aubergine	UC2096

Pebble

Pattern	Product code
Sindari	U1535
Nice	U1536
Waikiki	U1537
Siesta	U1538
South Beach	U1539
Schoolhouse	U1540
Mabua	U1541
Langkawi	U1542
Tenerife	U1543
Cape Cod	U1544
Maybay	U1545
Surfers Paradise	U1546
Negril	U1547
Papakolea	U1548
Chesil	U1549
Red Beach	U1550
Copacabana	U1551

Punch Card

Pattern	Product code
Alabaster	U2060
Carbon	U2061
Putty	U2062
Silver Lining	U2063
Crisp	U2064
Sky	U2065
Crimson	U2066
Orange	U2067
Navy	U2068
Cadet	U2069
Burgundy	U2070
Peat	U2071
Abys	U2072

Quattro

Pattern	Product code
Chalk	U1889
Deep Crimson	U1890
Golden Orange	U1891
Granite	U1892
Hibiscus	U1893
Honeycomb	U1894
Khaki	U1895
Laguna	U1896
Leaf	U1897
Mallard	U1898
Mercury	U1899
Midnight Blue	U1900
Pumice	U1901
Skyway	U1902
Spring Green	U1903
Umber	U1904
Wheat	U1905
Onyx	U4067

Cross Check

Pattern	Product code
Biscuit	U1552
Blue Ribbon	U1553
Bottle	U1554
Dove	U1555
Evergreen	U1556
Imperial	U1557
Lime	U1558
Marine	U1559
Otter	U1560
Paradise	U1561
Peacock	U1562
Platinum	U1563
Plumberry	U1564
Red Baron	U1565
Slate Black	U1566
Stone	U1567
Sunshine	U1568
Taupe	U1569
Vermillion	U1570

Proverb

Pattern	Product code
Anchor	U1740
Armor	U1741
Basalt	U1742
Buff	U1743
Cinder	U1744
Crystal	U1745
Linen	U1746
Mist	U1747
Oyster	U1748
Rye	U1749
Steel	U1750
Storm	U1751

Glint

Pattern	Product code
Barley	U1658
Caspian	U1659
Column	U1660
Gobi	U1661
Gypsum	U1662
Note	U1663
Pearl	U1664
Pumice	U1665
Relic	U1666
Rune	U1667
Serene	U1668
Shale	U1669
Sisal	U1670
Turret	U1671
Vera	U1672

Grade A Continued

Script

Pattern	Product code
Almond	U1752
Charcoal	U1753
Feldspar	U1754
Flint	U1755
Nectar	U1756
Patina	U1757
Pebble	U1758
Sand	U1759
Shadow	U1760
Slate	U1761
Sterling	U1762
Taupe	U1763
Zinc	U1764

Millennium

Pattern	Product code
Aglow	U1628
Amber	U1629
Anchor	U1630
Cascade	U1631
Cavern	U1632
Cerise	U1633
Clean	U1634
Coastal	U1635
Copper	U1636
Crisp	U1637
Electric	U1638
Geode	U1639
Lush	U1640
Mocha	U1641
Monument	U1642
Nectar	U1643
Onyx	U1644
Orchid	U1645
Peridot	U1646
Plateau	U1647
Pool	U1648
Pyrite	U1649
Safari	U1650
Sapphire	U1651
Spark	U1652
Steel	U1653
Tanzanite	U1654
Thrill	U1655
Voyage	U1656
Zinc	U1657

BeeHave

Pattern	Product code
Azure	U1825
Black	U1826
Carnelian	U1827
Clementine	U1828
Concord	U1829
Currant	U1830
Gris	U1831
Java	U1832
Lapis	U1833
Lemon	U1834
Pear	U1835
Pine	U1836
Plum	U1837
Slate	U1838

Odyssey

Pattern	Product code
Alloy	U1765
Amp	U1766
Breeze	U1767
Captain	U1768
Carbon	U1769
Cedar	U1770
Craft	U1771
Cruise	U1772
Dijon	U1773
Eggplant	U1774
Emerald	U1775
Fossil	U1776
Ink	U1777
Inlet	U1778
Iris	U1779
Kiss	U1780
Linen	U1781
Lively	U1782
Maritime	U1783
Nettle	U1784
Oliver	U1785
Opaque	U1786
Primary	U1787
Roast	U1788
Rue	U1789
Sangria	U1790
Skim	U1791
Smith	U1792
Tinge	U1793
Western	U1794

Tradition

Pattern	Product code
Ash	U1795
Branch	U1796
Class	U1797
Distant	U1798
Flirt	U1799
Fronde	U1800
Grain	U1801
Hedge	U1802
Hidden	U1803
Isle	U1804
Jazz	U1805
Kelly	U1806
Latte	U1807
Malbec	U1808
Miller	U1809
Mist	U1810
Peel	U1811
Plated	U1812
Regal	U1813
Sly	U1814
Soar	U1815
Soy	U1816
Spiced	U1817
Sprout	U1818
Sterling	U1819
Sun	U1820
Tango	U1821
Theater	U1822
Wash	U1823
Weld	U1824

Cadence

Pattern	Product code
Citrine	U1863
Coral	U1864
Garnet	U1865
Jade	U1866
Jet	U1867
Lapis	U1868
Opal	U1869
Pearl	U1870
Peridot	U1871
Quartz	U1872
Ruby	U1873
Sapphire	U1874
Topaz	U1875
Turquoise	U1876

Grade A Continued

Optic

Pattern	Product code
Ash	U1907
Brown Bear	U1908
Coal	U1909
Elephant	U1910
Fieldstone	U1911
Green Apple	U1912
Mulberry	U1913
Mushroom	U1914
Ocean	U1916
Red	U1917
Springtime	U1918
Sunrise	U1919
Tangerine	U1920
Yale	U1921

Intuition

Pattern	Product code
Admiral	U1849
Bisque	U1850
Charcoal	U1851
Coral	U1852
Hickory	U1853
Honey	U1854
Ochre	U1855
Peacock	U1856
Platinum	U1857
Sage	U1858
Sand	U1859
Scarlet	U1860
Slate	U1861
Viridian	U1862

Ranchero

Pattern	Product code
Basil	U1922
Black	U1923
Brandy	U1924
Chocolate	U1925
Driftwood	U1926
Ecru	U1927
Greige	U1928
Lipstick	U1929
Navy	U1930
Nickel	U1931
Sapphire	U1932
Sepia	U1933
Slate	U1934
Thunder	U1935

Fedora

Pattern	Product code
Aegean	U1583
Aquamarine	U1584
Bitumen	U1585
Cactus	U1586
Charcoal	U1587
Citron	U1588
Dapper	U1589
Dew	U1590
Espresso	U1591
Eucalyptus	U1592
Fawn	U1593
Indigo	U1594
Light Grey	U1595
Midnight	U1596
Mink	U1597
Opal	U1598
Persimmon	U1599
Pewter	U1600
Plumberry	U1601
Purple	U1602
Ruby	U1603
Tangelo	U1604
Tomato	U1605
Topaz	U1606
Winter	U1607

Prism

Pattern	Product code
Alabaster	U1690
Asparagus	U1691
Café Au Lait	U1692
Caramel	U1693
Caribbean	U1694
Cerulean	U1695
Charcoal	U1696
Claret	U1697
Clay	U1698
Clementine	U1699
Cornflower	U1700
Dove	U1701
Espresso	U1702
Indigo	U1703
Kale	U1704
Lipstick	U1705
Mocha	U1706
Olive	U1707
Onyx	U1708
Plum	U1709
Raisin	U1710
Stone	U1711
Tomato	U1712
Topaz	U1713
Zinc	U1714

Florentino

Pattern	Product code
Bark	U1936
Basil	U1937
Biscuit	U1938
Bluejay	U1939
Caramel	U1940
Chili	U1941
Cream	U1942
Dijon	U1943
Dove	U1944
Fern	U1945
Jet	U1946
Jonquil	U1947
Khaki	U1948
Latte	U1949
Lipstick	U1950
Mango	U1951
Marine	U1952
Mocha	U1953
Mushroom	U1954
Plum	U1955
Sable	U1956
Sapphire	U1957
Scarlet	U1958
Sepia	U1959
Slate	U1960
Turquoise	U1961
Willow	U1962

Key Largo

Pattern	Product code
Aegean	U1968
Cayenne	U1969
Chocolate	U1970
Crimson	U1971
Ebony	U1972
Gold Coast	U1973
Graphite	U1974
Jonquil	U1975
Jungle	U1976
Khaki	U1977
Nassau	U1978
Palm	U1979
Parchment	U1980
Pear	U1981
Quarry	U1982
Raspberry	U1983
Sand	U1984
Sandstone	U1985
Tangerine	U1986
Toast	U1987
Ultramarine	U1988
Wheat	U1989

Grade B

Crossweave

Pattern	Product code
Flax	UW1101
Antelope	UW1102
Mountain	UW1103
Straw	UW1104
Cantaloupe	UW1105
Tangelo	UW1106
Shiraz	UW1107
Flower	UW1108
Alfalfa	UW1109
Parsley	UW1110
Freshwater	UW1111
Lake	UW1112
Atlantic	UW1113
Soapstone	UW1114
Penguin	UW1115
Seal	UW1116

Tweed Multi

Pattern	Product code
Taupe	UW1001
Tan	UW1002
Dark Taupe	UW1003
Yellow	UW1004
Pink	UW1005
Flame	UW1006
Medium Blue	UW1007
Turquoise	UW1008
Dark Blue	UW1009
Green	UW1010
Orange	UW1011
Light Grey	UW1012
Medium Grey	UW1013

Quadrille

Pattern	Product code
Fair	UC1001
Cabaret	UC1002
Gambol	UC1003
Leisure	UC1004
Regalia	UC1005
Spring	UC1006
Zest	UC1007
Fiesta	UC1008
Carnival	UC1009
Spree	UC1010
Jubilee	UC1011
Opus	UC1012
Masquerade	UC1013
Soiree	UC1014
Revelry	UC1015
Escapade	UC1016
Shenanigan	UC1017

Evoke

Pattern	Product code
Breeze	U1877
Cerise	U1878
Flax	U1879
Graphite	U1880
Grey Mist	U1881
Iris	U1882
Mahogany	U1883
Natural	U1884
Noir	U1885
Pacific	U1886
Pear	U1887
Terracotta	U1888

Grade C

No patterns fall into Grade C at this time.

Grade D

Tiny Herringbone

Pattern	Product code
Tan	UW4201
Brown	UW4202
Blue Green	UW4203
Blue	UW4204
Medium Grey	UW4205
Dark Charcoal	UW4206

Notes:

COL (Customer Own Leather)

COL is available and will be quoted on a per order basis.

Contrasting topstitching

White contrasting topstitching is available on our Classic cushions only at no upcharge. Please specify at time of order placement.

Wood Legs

These legs are available on the Angled Leg Hip Support.

Colorways	Product code
Clear Oak	CLROAK
Black Oak	BLKOAK
Clear Maple	CLRMPL

Glass

Colorways	Product code
Clear	CL
Etched 1 Side	ET1
Etched 2 Sides	ET2
Gray	GRY
Laminate Glass	LG01

PET for Risers

Colorways	Product code
Pure Black	PET01
Silver Gray	PET03
Warm Charcoal	PET06

PET for Mobile Pedestal Soft Landing

Colorways	Product code
Black	PETS01

Storage

US Price List • June 2021



General Info

US Price List • June 2021

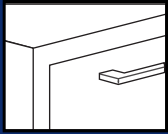
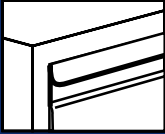
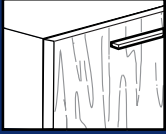

Series	Storage with Handles	9900 Series	GRID
Pull detail			

Laterals

Pre-configured in 7 heights	<input type="radio"/>		<input type="radio"/>
Build-up capability in 42 case heights		<input type="radio"/>	
3 drawer heights 3", 10½" & 12"	<input type="radio"/>		
3 drawer heights 6", 10½" & 12"			<input type="radio"/>
8 drawer heights 3" to 16½" (not 4½" or 9")			
10 drawer heights 3" to 16½"		<input type="radio"/>	
Hinged door cabinets	<input type="radio"/>	<input type="radio"/>	<input type="radio"/>

Multi units

24" Hinged door insert		<input type="radio"/>	
27" & 39" Hinged door inserts		<input type="radio"/>	
Bookcase/file cabinets		<input type="radio"/>	
Acoustical files			
Secure files		<input type="radio"/>	
4 Designer fronts		<input type="radio"/>	
Custom impression patterns			
Glazed doors			<input type="radio"/>

Pedestals

Desk height, letter width	<input type="radio"/>	<input type="radio"/>	<input type="radio"/>
Desk height, legal width		<input type="radio"/>	
Keyboard height, letter width		<input type="radio"/>	
Cushion pedestal, letter width		<input type="radio"/>	

Verticals

Letter & legal width		<input type="radio"/>	
Vertical towers			

Towers & lockers

Modular towers		<input type="radio"/>	
Lockers, Single-Use & Multi-Use		<input type="radio"/>	<input type="radio"/>

Exterior height	30" Wide				36" Wide				42" Wide			
	Weights		Cubes		Weights		Cubes		Weights		Cubes	
	lbs	(kg)	ft	(m)	lbs	(kg)	ft	(m)	lbs	(kg)	ft	(m)
17 5/8"	25	(11.3)	8	(.22)	31	(14)	10	(.28)	36	(16.3)	11	(.31)
19 3/8"	27	(12.2)	9	(.25)	34	(15.4)	10	(.28)	40	(18)	12	(.34)
20 7/8"	30	(13.6)	10	(.28)	38	(17.2)	11	(.31)	44	(19.9)	13	(.37)
22 5/8"	33	(14.9)	10	(.28)	41	(18.6)	12	(.34)	48	(21.7)	14	(.40)
23 7/8"	36	(16.3)	11	(.31)	44	(19.9)	13	(.37)	52	(23.5)	15	(.42)
25 5/8"	37	(16.7)	11	(.31)	45	(20)	13	(.37)	53	(24)	15	(.42)
26 7/8"	38	(17.2)	12	(.34)	46	(21)	14	(.40)	54	(24.5)	16	(.45)
28 5/8"	39	(17.6)	13	(.37)	47	(21.3)	15	(.42)	55	(24.9)	17	(.48)
29 7/8"	41	(18.6)	14	(.40)	49	(22.2)	16	(.45)	57	(25.8)	18	(.51)
31 5/8"	42	(19)	14	(.40)	50	(22.6)	16	(.45)	59	(26.7)	19	(.54)
32 7/8"	43	(19.5)	14	(.40)	52	(23.5)	17	(.48)	61	(27.6)	20	(.56)
34 5/8"	44	(19.9)	15	(.42)	53	(24)	18	(.51)	62	(28.1)	20	(.56)
35 7/8"	45	(20)	16	(.45)	54	(24.5)	18	(.51)	63	(28.5)	21	(.59)
37 5/8"	47	(21.3)	16	(.45)	56	(25.4)	19	(.54)	65	(29.4)	22	(.62)
38 7/8"	48	(21.7)	17	(.48)	58	(26.3)	20	(.56)	68	(30.8)	23	(.65)
40 5/8"	49	(22.2)	17	(.48)	59	(26.7)	20	(.56)	70	(31.7)	24	(.68)
41 7/8"	50	(22.6)	18	(.51)	60	(27.2)	21	(.59)	72	(32.6)	25	(.71)
43 5/8"	51	(23.1)	18	(.51)	62	(28.1)	22	(.62)	74	(33.5)	25	(.71)
44 7/8"	52	(23.5)	19	(.54)	64	(29)	23	(.65)	76	(34.4)	26	(.74)
46 5/8"	54	(24.5)	20	(.56)	66	(29.9)	23	(.65)	78	(35.3)	27	(.76)
47 7/8"	56	(25.4)	21	(.59)	68	(30.8)	24	(.68)	80	(36.2)	28	(.79)
49 5/8"	57	(25.8)	21	(.59)	69	(31.2)	25	(.71)	81	(36.7)	28	(.79)
50 7/8"	58	(26.3)	22	(.62)	70	(31.7)	26	(.74)	82	(37)	30	(.85)
52 5/8"	59	(26.7)	22	(.62)	71	(32.2)	26	(.74)	83	(37.6)	30	(.85)
53 7/8"	60	(27.2)	23	(.65)	72	(32.6)	27	(.76)	84	(38)	31	(.88)
55 5/8"	61	(27.6)	23	(.65)	73	(33)	27	(.76)	85	(38.5)	32	(.91)
56 7/8"	62	(28.1)	24	(.68)	74	(33.5)	28	(.79)	86	(39)	33	(.93)
58 5/8"	64	(29)	24	(.68)	75	(34)	29	(.82)	87	(39.4)	33	(.93)
59 7/8"	65	(29.4)	25	(.71)	76	(34.4)	30	(.85)	89	(40)	34	(.96)
61 5/8"	67	(30.3)	26	(.74)	78	(35.3)	30	(.85)	91	(41.2)	35	(.99)
62 7/8"	68	(30.8)	26	(.74)	79	(35.8)	31	(.88)	92	(41.7)	36	(1.0)
64 5/8"	70	(31.7)	27	(.76)	81	(36.7)	32	(.91)	94	(42.6)	37	(1.0)
65 7/8"	71	(32.2)	28	(.79)	82	(37)	33	(.93)	95	(43)	38	(1.0)
67 5/8"	73	(33)	28	(.79)	84	(38)	33	(.93)	97	(43.9)	38	(1.0)
68 7/8"	74	(33.5)	29	(.82)	85	(38.5)	34	(.96)	98	(44.4)	39	(1.1)
70 5/8"	75	(34)	29	(.82)	86	(39)	35	(.99)	99	(44.9)	40	(1.1)
71 7/8"	76	(34.4)	30	(.85)	87	(39.4)	36	(1.0)	100	(45)	41	(1.1)
73 5/8"	78	(35.3)	31	(.88)	89	(40)	36	(1.0)	102	(46.2)	42	(1.2)
74 7/8"	79	(35.8)	31	(.88)	90	(40.8)	37	(1.0)	103	(46.7)	43	(1.2)
76 5/8"	81	(36.7)	32	(.91)	92	(41.7)	37	(1.0)	104	(47)	43	(1.2)
77 7/8"	82	(37)	32	(.91)	93	(42)	37	(1.0)	105	(47.6)	43	(1.2)
79 5/8"	84	(38)	33	(.93)	95	(43)	39	(1.1)	—	—	—	—

General info

COM calculator & fabric layout For Classic and Lite Cushion Options

Cushion Width	Cushion Depth	Cushion Thickness	Fabric Orientation	Back to Back Lateral	Fabric Quantity (run inches)
12"	15.5"	1.25"	Off the bolt		26
15"	18"	1.25"	Off the bolt		28
15"	22"	1.25"	Off the bolt		32
15"	28"	1.25"	Off the bolt		38
15"	18.75"	1.25"	Off the bolt		29
15"	22.75"	1.25"	Off the bolt		33
15"	28.75"	1.25"	Off the bolt		39
15"	36"	1.25"	Off the bolt	• (Planna Peds)	47
30"	18"	1.25"	Off the bolt		28
30"	36"	1.25"	Off the bolt	•	47
36"	18"	1.25"	Off the bolt		29
36"	36"	1.25"	Off the bolt	•	47
42"	18"	1.25"	Off the bolt		29
42"	36"	1.25"	Off the bolt	•	47
60"	18"	1.25"	Off the bolt		N/A
66"	18"	1.25"	Off the bolt		N/A
72"	18"	1.25"	Off the bolt		N/A
78"	18"	1.25"	Off the bolt		N/A
84"	18"	1.25"	Off the bolt		N/A
12"	15.5"	1.25"	Railroad		22
15"	18"	1.25"	Railroad		25
15"	22"	1.25"	Railroad		25
15"	28"	1.25"	Railroad		25
15"	18.75"	1.25"	Railroad		25
15"	22.75"	1.25"	Railroad		25
15"	28.75"	1.25"	Railroad		25
15"	36"	1.25"	Railroad		25
30"	18"	1.25"	Railroad		41
30"	36"	1.25"	Railroad	•	41
36"	18"	1.25"	Railroad		47
36"	36"	1.25"	Railroad	•	47
42"	18"	1.25"	Railroad		52
42"	36"	1.25"	Railroad	•	52
60"	18"	1.25"	Railroad		69
66"	18"	1.25"	Railroad		75
72"	18"	1.25"	Railroad		83
78"	18"	1.25"	Railroad		87
84"	18"	1.25"	Railroad		93

Note: The COM Calculator indicates:

1 cushion yeild per piece

Up to 2 cushion yeild per piece

Up to 3 cushion yeild per piece

How to calculate COM yardage refer to 'COM fabric calculator'

Input

1. Select cushion width and depth appropriate to your specification
2. Select cushion thickness
3. Select fabric orientation (refer to 'Cushion Layout' sketches
4. Find the corresponding fabric quantity in 'running inches' from the table

Calculation

1. Multiply the number of cushions required by the fabric quantity in 'running inches' off of the table
2. Divide the number of running inches by 36 to convert to yardage required. Round up to the nearest half yard.
3. If a pattern repeat is required, ordering a sample cushion is advised to determine fabric yardage and any applicable upcharges. A layout instruction will also be required for review.

Example:

- Storage with Handles Pedestal
- Quantity - 31 cushions
- 15" wide x 22" deep x 1.25" thick
- COM fabric is a solid color and has no directional weave; best fabric usage is 'off the bolt' orientation.

Note: The COM Calculator indicates:

Up to 2 cushion yeild per piece

Calculation:

32 running inches x 16 cushions = 512" of fabric required

512" divided by 36 = 14yds, 8"

Total fabric required = 14 ½ yards (rounded up)

Additional Specification Information:

1. Pedestal Cushion Depth options vary by product profile and application. Ensure you are referencing the correct dimensions
2. Lateral Cushion Depth options vary by application Ensure you are referencing the correct dimensions
3. Fabric Quantity is based on a 54" wide roll
4. Highlighted rows yield 2 cushions per fabric quantity listed
5. All directional/patterned fabrics (Graded or COM) require cushion layout instructions with order placement. Depending on layout additional fabric may be required and upcharges may apply. If layout instructions are not provided the layout that maximizes the production yield will be chosen. (Refer to the layout diagrams)
6. For any cushion sizes not listed on the COM Calculator or for further information please contact your Client Service Representative for assistance

Fabric layout

Lateral cushion fabric layout

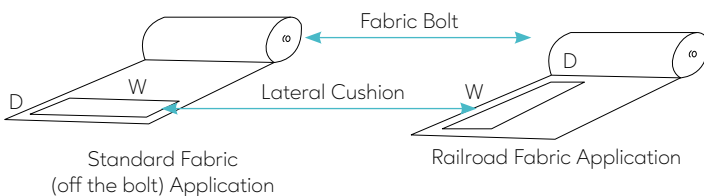

Pedestal cushion fabric layout

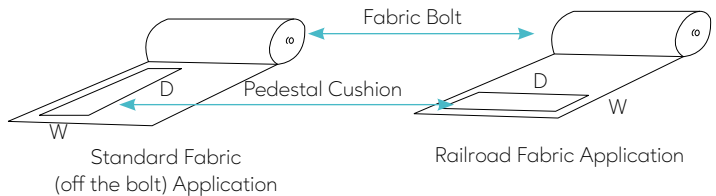

For COM fabric testing, please provide the following to your SRT – Customer Experience specialist:

- (4) memo samples of the fabric to be tested
- Product Code that the fabric is to be applied to

General testing turnaround times are 48 to 72 hours upon receipt of memos samples. Your Customer Experience specialist will provide the results of the application testing.

The Power of 1 1/2 inches

All Office Specialty laterals are manufactured in 1 1/2" increments allowing you to design storage that works for you.

With 42 different case heights ranging in size from 18" to 80", you can match virtually any panel, storage or worksurface height letting you create practically any design combination.









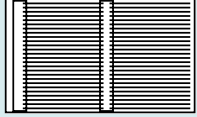
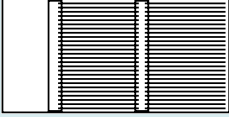
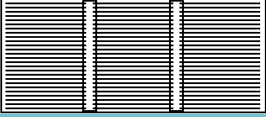

The Panel Height Compatibility Matrix shows Office Specialty's case heights against the most commonly used panel heights.

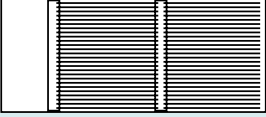
Panel Height Compatibility Matrix

Office Specialty's case heights

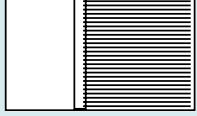
	Lateral files	Workplace lockers & towers	Modular towers
30"	29 7/8"		
33"	32 7/8"		
34"	32 7/8"		
36"	35 7/8"		
38"	37 3/8"		36 1/4"
39"	38 7/8"		
40"	38 7/8"		
42"	41 7/8"		
45"	44 7/8"	43 3/8"	
47"	46 3/8"		46 3/4"
48"	47 7/8"		
49"	47 7/8"		48 1/4"
50"	49 3/8"		49 3/4"
51"	50 7/8"		
53"	52 3/8"		
54"	53 7/8"		
56"	55 3/8"		
62"	61 3/8"	61 3/8"	61 3/4"
63"	62 7/8"	62 7/8"	
64"	62 7/8"		63 1/4"
66"	65 7/8"		
67"	65 7/8"		
68"	67 3/8"		
70"	68 7/8"		

For front-to-back filing

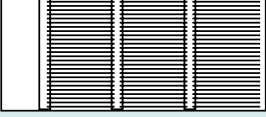
Type of Filing	30" Wide	36" Wide	42" Wide
Letter size	 <p>2-SR (30")</p>	 <p>2-SR (30")</p>	 <p>2-SR (45")</p>
Legal size	 <p>1-SR (15")</p>	 <p>2-SR (30")</p>	 <p>2-SR (30")</p>
14 7/8" x 11" EDP	 <p>1-SR (15")</p>	 <p>1-SR (30")</p>	 <p>2-SR (30")</p>
14 7/8" x 8 1/2" EDP	 <p>1-SR (15")</p>	 <p>1-SR (30")</p>	 <p>2-SR (30")</p>
8 1/2" x 11" EDP	 <p>2-SR (30")</p>	 <p>3-SR (45")</p>	 <p>3-SR (45")</p>

Highest efficiency

General info

For all product lines except modular towers & GRID

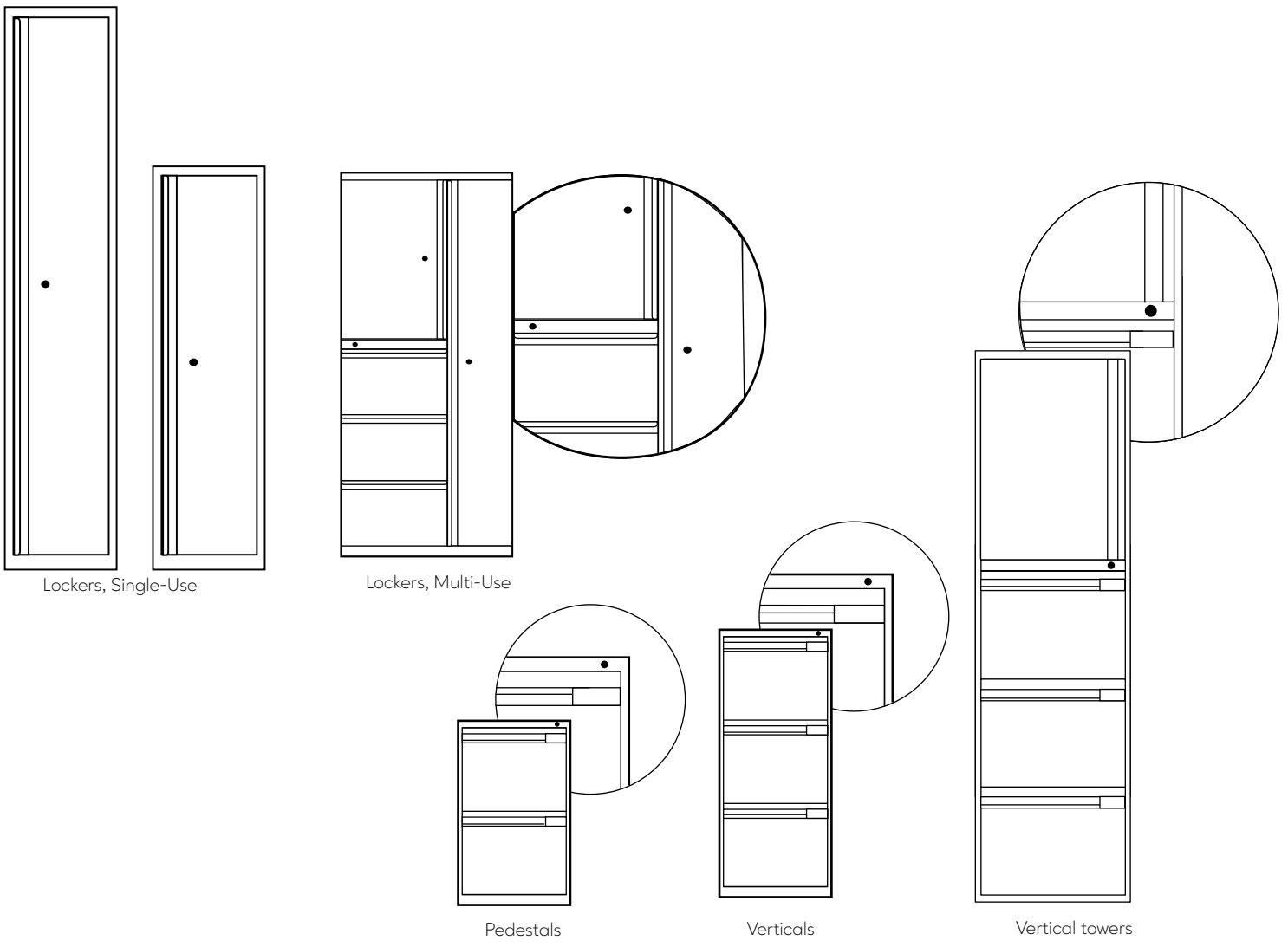
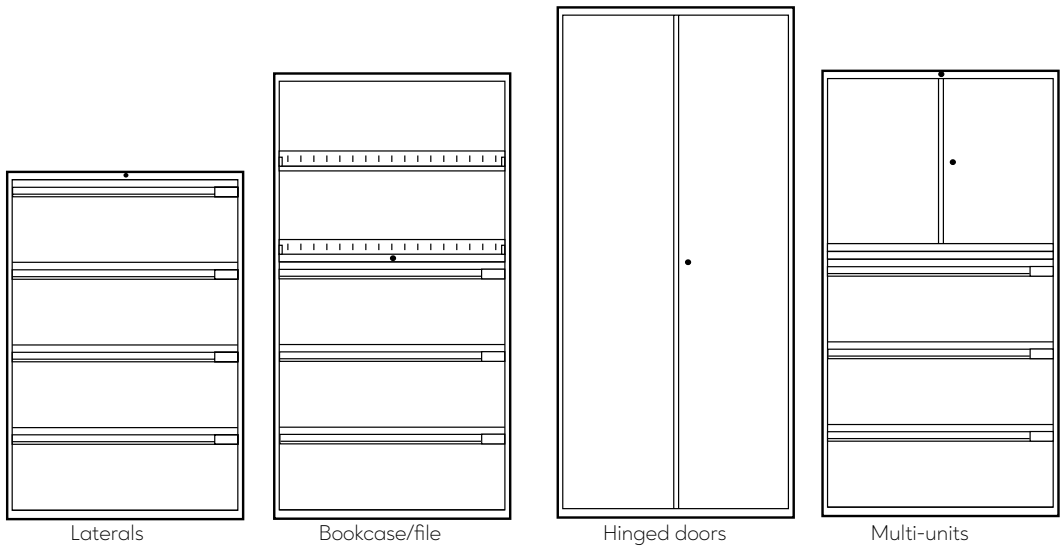

Modular towers

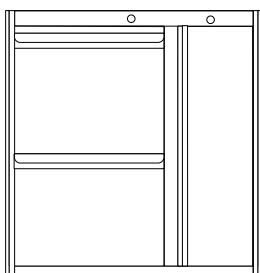
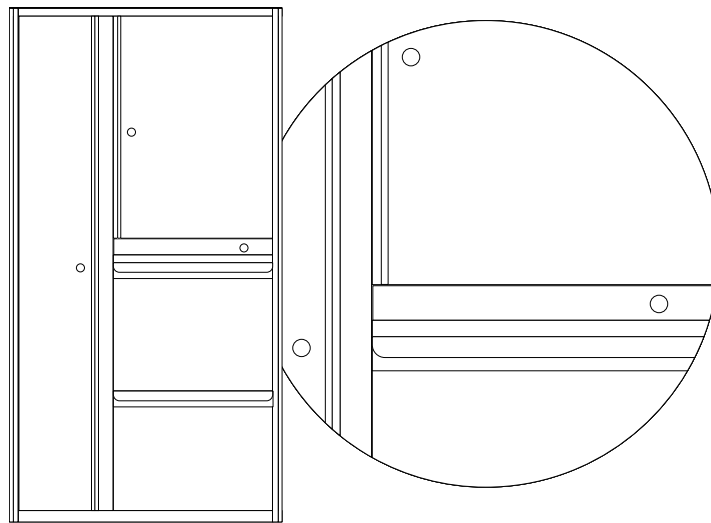
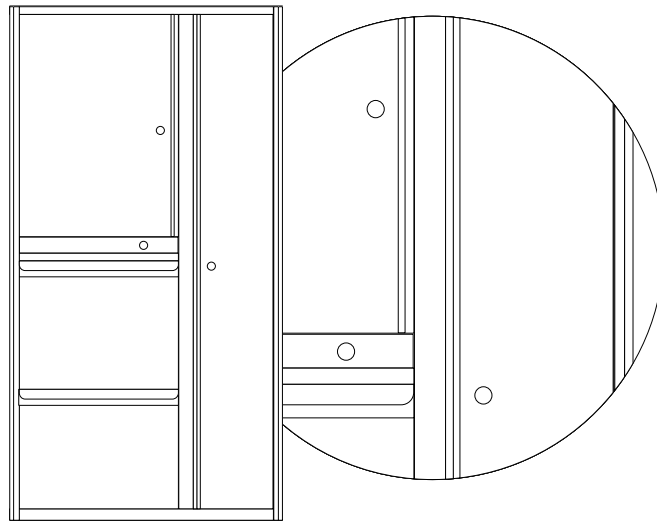

With MoPed

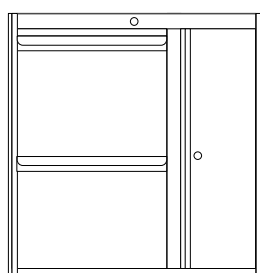

With Hinged Door

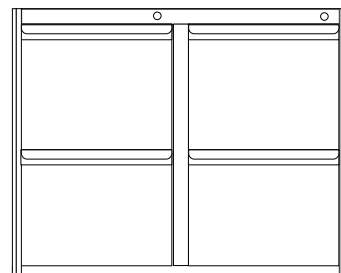

Double Pedestal Base Module

General info

Lock locations

GRID

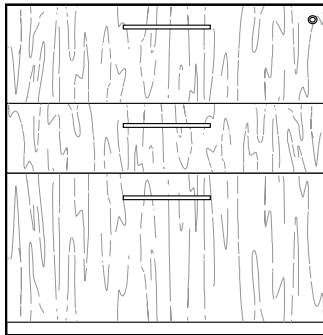

Laterals

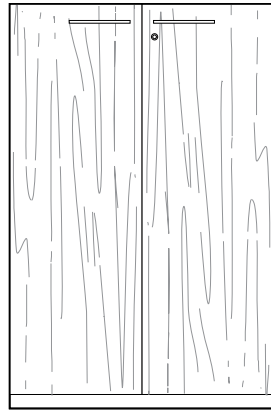

Hinged doors
- 24" interior height

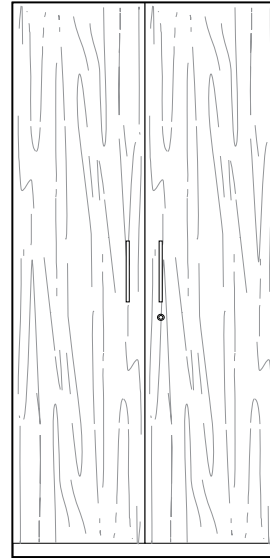

Hinged doors
- all except 24" interior height

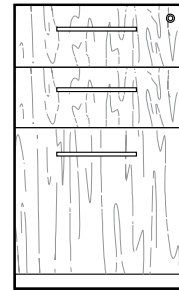

Pedestals

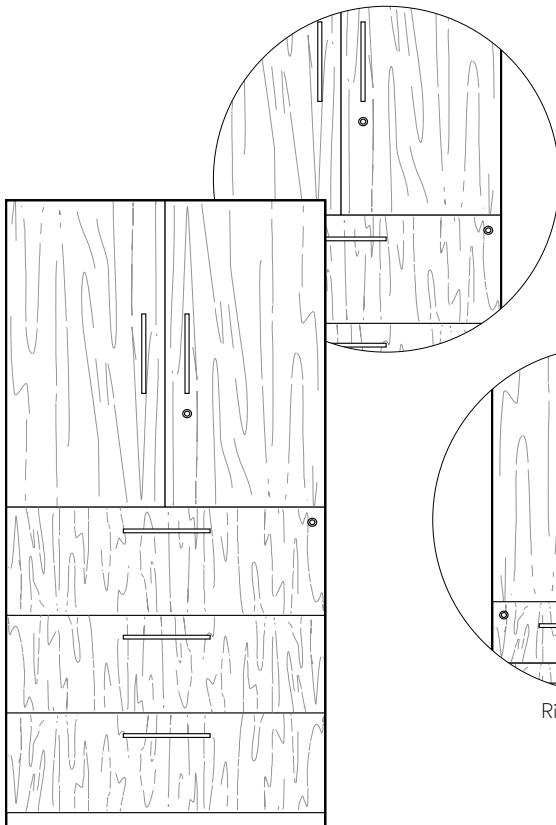

Multi-units

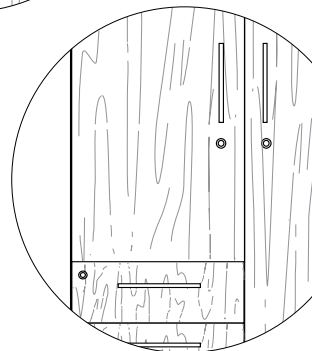

Right hand hinged
door detail

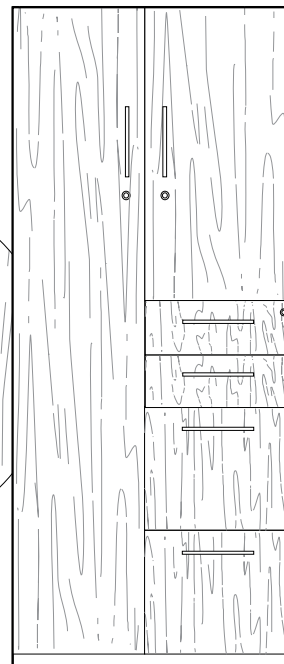

Lockers, Multi-Use
- Left hand hinged door

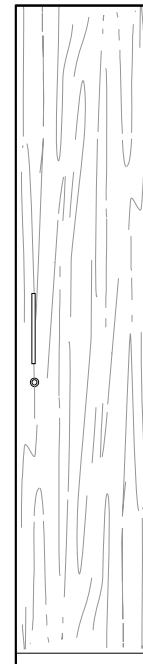

Lockers, Single-Use

Product	Can counterweight be ordered during lateral cabinet order entry?	Can Counterweight be installed in factory?	Field installed counterweight order entry code*
30"W Laterals - 21"I.D. & lower	YES	NO	CW
36"W Laterals - 21"I.D. & lower	YES	NO	CW
42"W Laterals - 21"I.D. & lower	YES	NO	CW
30"W Laterals - 22.5"I.D. & higher	YES	NO	IMCW-30
36"W Laterals - 22.5"I.D. & higher	YES	NO	IMCW-36
42"W Laterals - 22.5"I.D. & higher	YES	NO	IMCW-42
Split unit laterals (Storwal)	NO	NO	N/A
Lat/ped combo laterals	NO always included	YES	PFCW
Glide pedestals/verticals	YES	YES	WS-CW
Mobile pedestals (except Storage with Handles series)	NO always included	NO	PM-CW
Storage with Handles Mobile Pedestals	NO always included	NO	PM-CW79
Waste/Recycle Verticals	YES	NO	PFCW3
Workplace towers & lockers	NO	NO	N/A
Modular towers (except double pedestal)	NO	NO	N/A
Double-pedestal modular towers	NO always included	NO	CW
All non-standard (special) laterals, pedestals, etc.	To be advised by Engineering Specials Department		

*Notes:

Innviromass™ counterweight plates are to be field installed into lateral file cabinets by inserting a 30", 36" or 42" wide retaining wire into holes in the left and right hand rear strips. To accommodate these wires, the .141" diameter holes in rear strips have been changed to .148" diameter.

Innviromass™ counterweight plates are to be field installed into Mobile pedestals (except Storage with Handles) using one security bracket and two strips of double-coated tape for each counterweight plate. The security bracket and double-coated tape is supplied with the counterweight, but must be applied to the counterweight in the field per the Counterweight Installation Instruction sheet.

The Innviromass™ counterweights for field installation 'IMCW-30, IMCW-36 & IMCW-42' consist of one Innviromass plate and one retaining wire.

- The 'CW' counterweight for field installation consists of two 24LB steel plates
- The 'WS-CW' counterweight for field installation consists of one 16LB steel plate
- The 'PM-CW' counterweight for field installation consists of one 24LB Innviromass™ plate, one security bracket and two strips of double-coated tape.
- The 'PM-CW79' counterweight for field installation consists of one 24LB steel plate
- The 'PFCW' counterweight for field installation consists of two 16LB steel plates
- The 'PFCW3' counterweight for field installation consists of three 16LB steel plates

Any non-standard (special) lateral file cabinet, pedestals, vertical etc. for which there is a requirement for counterweights must be reviewed by the Engineering specials department before the order is released to Production. This applies to new product requests AND product that has been ordered in the past.

At this time, counterweights for Lockers, Towers and Modular Towers (except double-pedestal Modular Tower) are not available. Any requests for these products with a counterweight must be routed to the Engineering Specials Department.



2Stor

US Price List • June 2021



- Pedestals are constructed of steel and can be optioned in any of Office Specialty's standard paint colors
- Optional locking for box drawers only
- Classic Cushion included
- Optional PET Soft Landing available on select pedestals (black only)
- Push to open slides – push circle to open and close (full extension)
- For RK1215-BFM5, front three casters are fixed, rear two casters swivel

Lock option

Storage drawers come standard with lock. If lock is not required add suffix 'NL' after product number. Deduct \$54 list

Finishes

Available in Office Specialty's standard finishes. Refer to [Finishes section](#) for finish options for case and fronts. Drawer bodies and accessories are finished in Eco Black.

Description	Part number	Height	Width	Depth	Classic cushion grade A/ Neutral paint/ Base price	PET Soft Landing upcharge	Case accent paint upcharge	Drawer accent paint upcharge
 Box/Open Mobile Pedestal with cushion	2S1215-BOM	20 ½"	12"	15 ½"	\$735	-\$108	+\$76	+\$37
 Box/File Mobile Pedestal with cushion	2S1215-BFM5	20 ½"	12"	15 ½"	\$983	-\$108	+\$76	+\$76

Description	Part number	Thickness	Width	Depth	Grade A/ base price
 Replacement cushion for 2Stor Mobile Pedestal	2SCUSH1215	1 ¼"	12"	15 ½"	\$266

Fabric upcharge for mobile (standard) cushion pedestals - Classic Cushion option only

Note: To price fabric grade options, add the upcharge (+\$) in the chart below to the base price of the List price (Grade A) column. This will be the total cost for that product.

Grade B/COM	Grade C	Grade D
+\$54	+\$100	+\$141

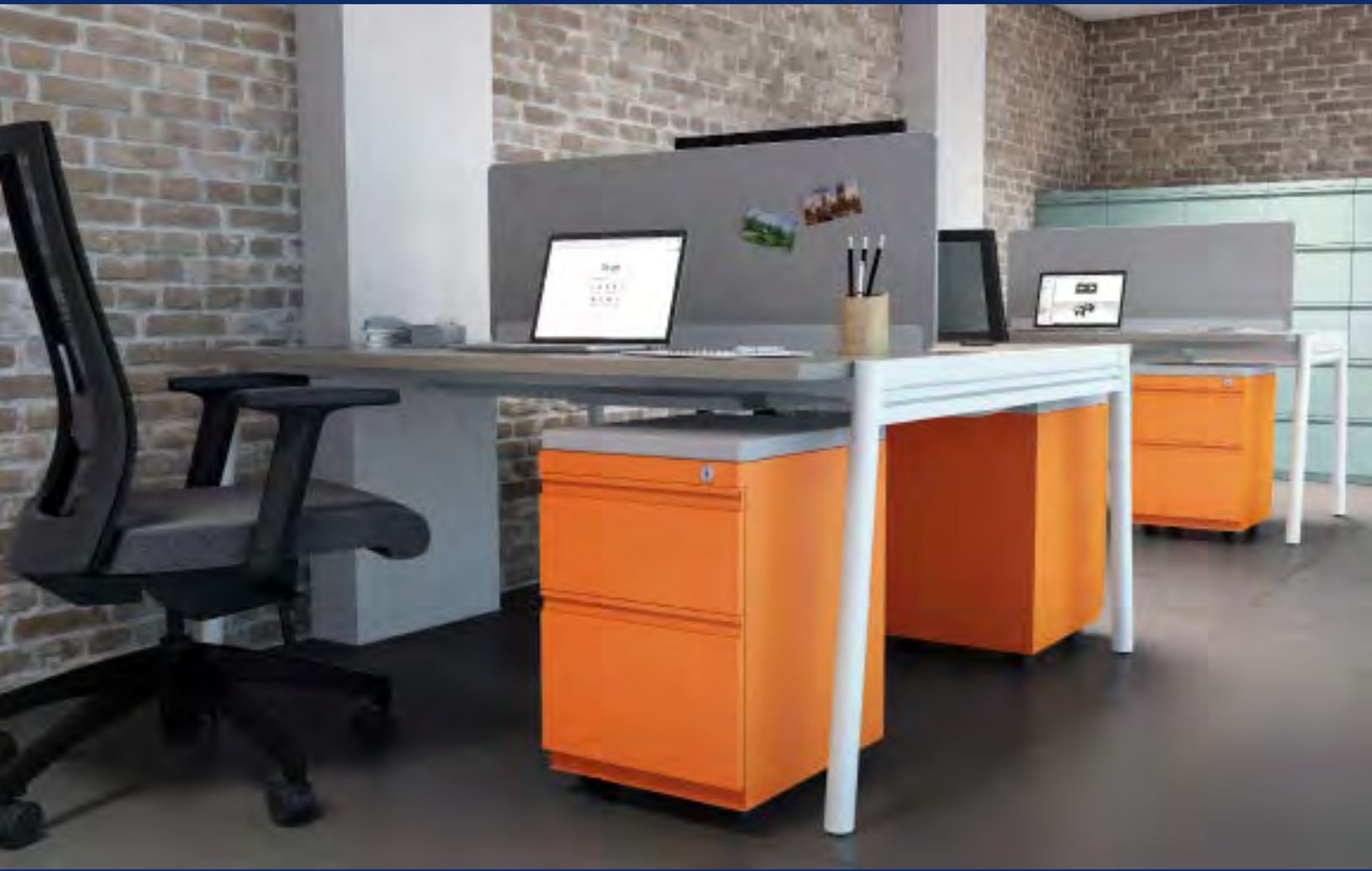

9900 Series Pedestals

US Price List • June 2021

9900 Series Pedestals

ANSI/BIFMA

With the addition of counterweights where appropriate, pedestals meet all ANSI/BIFMA specifications.

Construction

Pedestals are welded, “wrap-around” construction. 9900 Series pedestals use 18 and 20 gauge steel. All pedestals use high quality, tension level, cold rolled steel. The steel gauges selected for drawer fronts, bodies and accessories ensure the highest quality durability and performance for all components.

Construction features & benefits

1. “Wrap-around” construction with no visible vertical seams gives a clean appearance.
2. Completely enclosed case provides rigid construction and dust-free interiors.
3. Box drawer sides are slotted on 1” centers to allow for maximum flexibility for drawer division.
4. File (10½” and 12”) drawer bodies have full-height sides to accommodate hanging file folders, eliminating the need for optional file frames.
5. Fully-progressive ball bearing suspensions on all drawers, including pencil and box drawers, are staged so that left and right sides work in unison. This provides smooth drawer operation with minimum force.
6. Staged suspensions allow the drawer to be completely pulled out, providing access to the entire drawer depth.
7. Special “claw-like” device incorporated in the suspension “grips” the fixed section of the suspension arm preventing drawer bounce-back or creep when drawer is closed.
8. Casters and glides are both recessed “inboard” for a uniform exterior appearance with no visible hardware.
9. Modular interior allows for complete interchangeability of drawer types within the pedestal case. For example, two 6” box drawers may be replaced by one 12” file drawer.

Counterweights

Counterweights are required for ALL freestanding units that are not anchored or ganged to other cabinets or bolted to walls/floor. Counterweights come standard with ALL mobile pedestals and must be field installed.

Optional Handle

Mobile Pedestals have the option to select a face mounted contemporary style handle for the case. There is an upcharge of \$32 list if this handle is selected. This handle is available in two finish options: Brushed Nickel (default) or Polished Nickel.

Casters

Four swivel, recessed 1⅝” black, double-wheel phenolic carpet casters are supplied with mobile pedestals and must be field installed. Recessed casters are not visible.

Drawer Standard Equipment

15” letter width storage drawers: 3” pencil drawer, 6” box drawer, 10½” and 12” file drawer are standard.

Pedestals containing 3” or 6” drawers have the option to order one pencil tray per pedestal. 6” drawers have the additional option to order one steel divider.

10½” and 12” letter-width file drawers have the option to order suspension bar (two in a 28” deep pedestal) for side-to-side filing of legal or letter-size folders.

Bases

Optional base aprons are available in 2 standard heights and are screwed to the underside of the pedestal case. Bases may be easily added or changed on site. When ordered, shipped with bases installed.

Glides

Overall heights are inclusive of metal glides. Heights may be increased up to ⅝” by extending standard glide. Glides are accessible from inside the pedestal when the bottom drawer is fully extended or removed and may be adjusted with a ¼” socket driver.

Optional 1½” stem glides are available. Specify separately and add \$30 list to the pedestal price. Requires field installation.

Locks

Pedestals come standard with lock. If lock is not required add suffix ‘/NL’ after product number. Deduct \$57 list per lock. For lock location, see the guide at the beginning of this price list. Mobile pedestals must include locks.

Random keying is standard. Pedestals may be ordered keyed alike. Specify. Locks feature removable core and are standard with two keys, one of which has a black neoprene plastic key cover.

Pedestals originally ordered as non-locking may be field installed with the addition of locking bars and a lock core.

Please contact Client Services for assistance.

Master keys are available at \$51 list.

Finishes

Refer to [Finishes section](#) for color options. For lock finish options, refer to the front of this price list.

Drawer Pulls

9900 Series fronts have full width integral pulls with enamel finish to match case fronts.

9900 Series Pedestals

Freestanding, Letter Width

How to order

1. Specify product number.
2. Specify finish color.
3. Specify options.

Product code key example 1522E-B7FM

- 15** pedestal width
22 pedestal depth
E 9900 Series
B7 7½" box drawer
F 12" file drawer
M mobile

Pedestals are standard with either glides or casters. Exterior pedestal heights are nominal. Actual heights (with glides fully recessed) are ⅛" less. **Pedestal depths are nominal. Actual depth for 9900 Series are ¾" more than noted.** Casters must be field installed. Optional handle for mobile cushion pedestals, \$32 list.

Counterweights

Counterweights are required for ALL freestanding units that are not anchored or ganged to other cabinets or bolted to walls/floor.

Counterweights are standard with all mobile pedestals and must be field installed. See [Counterweight matrix](#).

See [Pedestal Accessories](#) section for counterweight codes and pricing.

Lock option

Pedestals come standard with lock. If lock is not required add suffix '/NL' after product number. Deduct \$57 list.

Finishes

Refer to [Finishes section](#) for color options. Drawer bodies and accessories are finished in Eco Black.

Optional Accessories

All pedestal accessories are optional. See chart below for information on accessories by drawer height.

Drawer Height	Product Code	Product Description	Price
3" & 4.5"	WS-PTxx	Pencil Tray	\$37
6" & 7.5"	WS-PTxx	Pencil Tray	\$37
	WS-DVxx	Divider	\$22
18"D, 22"D, 28"D Pedestals Only (28"D requires 2 per drawer)			
10.5", 12", 13.5, & 15"	SSFxx	Side-To-Side Filing Bar	\$8

Visit the [Pedestal Accessories](#) section for full accessory details.

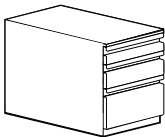
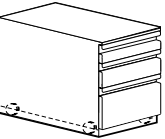
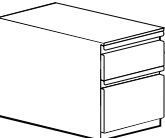
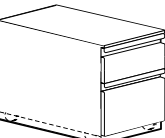
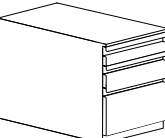
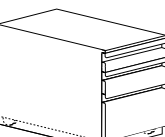
Description	Part number	Exterior Height	Case depth	Weight (lbs)	9900 series/ Neutral paint	Accent paint
 1-3" pencil, 1-6" box, 1-10.5" file glides	1518E-PBF10	22 ¾"	18"	75	\$898	+\$92
	1522E-PBF10	22 ¾"	22"	85	\$1001	+\$102
	1528E-PBF10	22 ¾"	28"	95	\$1052	+\$107
 1-3" pencil, 1-6" box, 1-10.5" file, mobile, counterweights are included Mobile pedestals must be locking	1518E-PBF10M	23"	18"	80	\$975	+\$111
	1522E-PBF10M	23"	22"	90	\$1058	+\$121
	1528E-PBF10M	23"	28"	100	\$1141	+\$127
 1-7.5" box, 1-12" file glides	1518E-B7F	22 ¾"	18"	75	\$791	+\$83
	1522E-B7F	22 ¾"	22"	85	\$876	+\$91
	1528E-B7F	22 ¾"	28"	95	\$914	+\$94
 1-7.5" box, 1-12" file, mobile, counterweights are included Mobile pedestals must be locking	1518E-B7FM	23"	18"	80	\$978	+\$100
	1522E-B7FM	23"	22"	90	\$1063	+\$108
	1528E-B7FM	23"	28"	100	\$1100	+\$112
 1-3" pencil, 1-6" box, 1-12" file glides	1518E-PBF	23 ¾"	18"	75	\$898	+\$92
	1522E-PBF	23 ¾"	22"	85	\$1001	+\$102
	1528E-PBF	23 ¾"	28"	95	\$1052	+\$107
 1-3" pencil, 1-6" box, 1-12" file, mobile, counterweights are included Mobile pedestals must be locking	1518E-PBFM	24 ½"	18"	80	\$975	+\$111
	1522E-PBFM	24 ½"	22"	90	\$1058	+\$121
	1528E-PBFM	24 ½"	28"	100	\$1141	+\$127

9900 Series Pedestals

Freestanding, Letter Width

How to order

1. Specify product number.
2. Specify finish color.
3. Specify options.

Product code key example 1522E-2F10.5M

15 pedestal width
22 pedestal depth
E 9900 Series
2 7½" box drawer
F10.5 10½" file drawer
M mobile

Pedestals are standard with either glides or casters. Exterior pedestal heights are nominal. Actual heights (with glides fully recessed) are ⅛" less. **Pedestal depths are nominal. Actual depth for 9900 Series are ¾" more than noted.** Casters must be field installed.

Optional handle for mobile cushion pedestals, \$32 list.

Counterweights

Counterweights are required for ALL freestanding units that are not anchored or ganged to other cabinets or bolted to walls/floor.

Counterweights are standard with all mobile pedestals and must be field installed. See [Counterweight matrix](#).

See [Pedestal Accessories](#) section for counterweight codes and pricing.

Lock option

Pedestals come standard with lock. If lock is not required add suffix '/NL' after product number. Deduct \$57 list.

Finishes

Refer to [Finishes section](#) for color options. Drawer bodies and accessories are finished in Eco Black.

Optional Accessories

All pedestal accessories are optional. See chart below for information on accessories by drawer height.

Drawer Height	Product Code	Product Description	Price
3" & 4.5"	WS-PTxx	Pencil Tray	\$37
6" & 7.5"	WS-PTxx	Pencil Tray	\$37
	WS-DVxx	Divider	\$22
18"D, 22"D, 28"D Pedestals Only (28"D requires 2 per drawer)			
10.5", 12", 13.5, & 15"	SSFxx	Side-To-Side Filing Bar	\$8

Visit the [Pedestal Accessories](#) section for full accessory details.

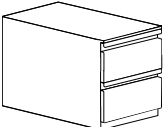
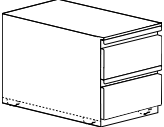
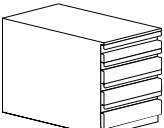
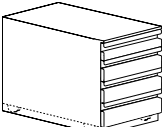
Description	Part number	Exterior Height	Case depth	Weight (lbs)	9900 series/ Neutral paint	Accent paint
 2-10.5" file glides	1518E-2F10.5	23 ⅞"	18"	75	\$844	+\$88
	1522E-2F10.5	23 ⅞"	22"	85	\$914	+\$94
	1528E-2F10.5	23 ⅞"	28"	95	\$950	+\$98
 2-10.5" file, mobile, counterweights are included Mobile pedestals must be locking	1518E-2F10.5M	24 ½"	18"	80	\$1031	+\$105
	1522E-2F10.5M	24 ½"	22"	90	\$1100	+\$112
	1528E-2F10.5M	24 ½"	28"	100	\$1138	+\$116
 1-3" pencil, 3-6" box glides	1518E-P3B	23 ⅞"	18"	75	\$970	+\$100
	1522E-P3B	23 ⅞"	22"	85	\$1124	+\$115
	1528E-P3B	23 ⅞"	28"	95	\$1188	+\$121
 1-3" pencil, 3-6" box, mobile, counterweights are included Mobile pedestals must be locking	1518E-P3BM	24 ½"	18"	80	\$1156	+\$119
	1522E-P3BM	24 ½"	22"	90	\$1312	+\$133
	1528E-P3BM	24 ½"	28"	100	\$1375	+\$140

9900 Series Pedestals

Freestanding, Letter Width

How to order

1. Specify product number.
2. Specify finish color.
3. Specify options.

Product code key example 1522E-2BF10M

15	pedestal width
22	pedestal depth
E	9900 Series
2B	7½" box drawer
F10	10½" file drawer
M	mobile

Pedestals are standard with either glides or casters. Exterior pedestal heights are nominal. Actual heights (with glides fully recessed) are ⅛" less. **Pedestal depths are nominal. Actual depth for 9900 Series are ¾" more than noted.** Casters must be field installed.

Optional handle for mobile cushion pedestals, \$32 list.
27 ½"h mobile pedestals do NOT fit under a standard 28.5"h worksurface.

Counterweights

Counterweights are required for ALL freestanding units that are not anchored or ganged to other cabinets or bolted to walls/floor.

Counterweights are standard with all mobile pedestals and must be field installed. See [Counterweight matrix](#).

See [Pedestal Accessories](#) section for counterweight codes and pricing.

Lock option

Pedestals come standard with lock. If lock is not required add suffix '/NL' after product number. Deduct \$57 list.

Finishes

Refer to [Finishes section](#) for color options. Drawer bodies and accessories are finished in Eco Black.

Optional Accessories

All pedestal accessories are optional. See chart below for information on accessories by drawer height.

Drawer Height	Product Code	Product Description	Price
3" & 4.5"	WS-PTxx	Pencil Tray	\$37
6" & 7.5"	WS-PTxx	Pencil Tray	\$37
	WS-DVxx	Divider	\$22
18"D, 22"D, 28"D Pedestals Only (28"D requires 2 per drawer)			
10.5", 12", 13.5, & 15"	SSFxx	Side-To-Side Filing Bar	\$8

Visit the [Pedestal Accessories](#) section for full accessory details.

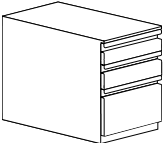
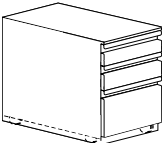
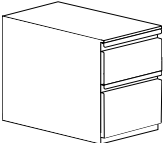
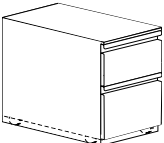
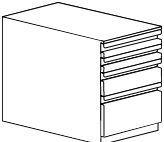
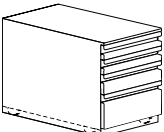
Description	Part number	Exterior Height	Case depth	Weight (lbs)	9900 series/ Neutral paint	Accent paint
 2-6" box, 1-10.5" file glides	1518E-2BF10	25 ⅜"	18"	80	\$915	+\$94
	1522E-2BF10	25 ⅜"	22"	90	\$1036	+\$105
	1528E-2BF10	25 ⅜"	28"	100	\$1086	+\$111
 2-6" box, 1-10.5" file, mobile, counterweights are included Mobile pedestals must be locking	1518E-2BF10M	26"	18"	85	\$1102	+\$112
	1522E-2BF10M	26"	22"	95	\$1222	+\$125
	1528E-2BF10M	26"	28"	105	\$1273	+\$130
 1-10.5" file, 1-12" file glides	1518E-F10F	25 ⅜"	18"	80	\$844	+\$88
	1522E-F10F	25 ⅜"	22"	90	\$914	+\$94
	1528E-F10F	25 ⅜"	28"	100	\$950	+\$98
 1-10.5" file, 1-12" file, mobile, counterweights are included Mobile pedestals must be locking	1518E-F10FM	26"	18"	85	\$1031	+\$105
	1522E-F10FM	26"	22"	95	\$1100	+\$112
	1528E-F10FM	26"	28"	105	\$1138	+\$116
 2-3" pencil, 1-6" box, 1-10.5" file glides	1518E-2PBF10	25 ⅜"	18"	80	\$1004	+\$103
	1522E-2PBF10	25 ⅜"	22"	90	\$1125	+\$115
	1528E-2PBF10	25 ⅜"	28"	100	\$1194	+\$123
 2-3" pencil, 1-6" box, 1-10.5" file, mobile, counterweights are included Mobile pedestals must be locking	1518E-2PBF10M	26"	18"	85	\$1194	+\$123
	1522E-2PBF10M	26"	22"	95	\$1313	+\$133
	1528E-2PBF10M	26"	28"	105	\$1380	+\$140

9900 Series Pedestals

Freestanding, Letter Width

How to order

1. Specify product number.
2. Specify finish color.
3. Specify options.

Product code key example

1522E-B4B7FM

- 15** pedestal width
- 22** pedestal depth
- E** 9900 Series
- B4** 4½" box drawer
- B7** 7½" box drawer
- F** 12" file drawer
- M** mobile

Pedestals are standard with either glides or casters. Exterior pedestal heights are nominal. Actual heights (with glides fully recessed) are ⅛" less. **Pedestal depths are nominal. Actual depth for 9900 Series are ¾" more than noted.** Casters must be field installed.

Optional handle for mobile cushion pedestals, \$32 list.

27 ½"h mobile pedestals **do not** fit under a standard 28.5"h worksurface.

Counterweights

Counterweights are required for ALL freestanding units that are not anchored or ganged to other cabinets or bolted to walls/floor.

Counterweights are standard with all mobile pedestals and must be field installed. See [Counterweight matrix](#).

See [Pedestal Accessories](#) section for counterweight codes and pricing.

Lock option

Pedestals come standard with lock. If lock is not required add suffix **'/NL'** after product number. Deduct \$57 list.

Finishes

Refer to [Finishes section](#) for color options. Drawer bodies and accessories are finished in Eco Black.

Optional Accessories

All pedestal accessories are optional. See chart below for information on accessories by drawer height.

Drawer Height	Product Code	Product Description	Price
3" & 4.5"	WS-PTxx	Pencil Tray	\$37
6" & 7.5"	WS-PTxx	Pencil Tray	\$37
	WS-DVxx	Divider	\$22
18"D, 22"D, 28"D Pedestals Only (28"D requires 2 per drawer)			
10.5", 12", 13.5, & 15"	SSFxx	Side-To-Side Filing Bar	\$8

Visit the [Pedestal Accessories](#) section for full accessory details.

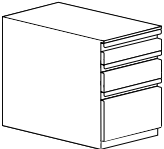
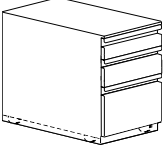
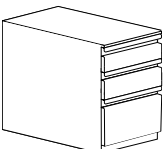
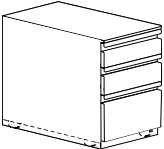
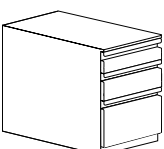
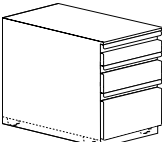
Description	Part number	Exterior Height	Case depth	Weight (lbs)	9900 series/ Neutral paint	Accent paint
 1-4.5" box, 1-7.5" box, 1-12" file glides	1518E-B4B7F	26 ⅞"	18"	80	\$835	+\$94
	1522E-B4B7F	26 ⅞"	22"	90	\$918	+\$105
	1528E-B4B7F	26 ⅞"	28"	100	\$1002	+\$111
 1-4.5" box, 1-7.5" box, 1-12" file, mobile, counterweights are included Mobile pedestals must be locking	1518E-B4B7FM	27 ½"	18"	85	\$1102	+\$112
	1522E-B4B7FM	27 ½"	22"	95	\$1222	+\$125
	1528E-B4B7FM	27 ½"	28"	105	\$1273	+\$130
 1-6" box, 1-7.5" box, 1-10.5" file glides	1518E-BB7F10	26 ⅞"	18"	80	\$835	+\$94
	1522E-BB7F10	26 ⅞"	22"	90	\$918	+\$105
	1528E-BB7F10	26 ⅞"	28"	100	\$1002	+\$111
 1-6" box, 1-7.5" box, 1-10.5" file, mobile, counterweights are included Mobile pedestals must be locking	1518E-BB7F10M	27 ½"	18"	85	\$1102	+\$112
	1522E-BB7F10M	27 ½"	22"	95	\$1222	+\$125
	1528E-BB7F10M	27 ½"	28"	105	\$1273	+\$130
 2-6" box, 1-12" file glides	1518E-2BF	26 ⅞"	18"	80	\$835	+\$94
	1522E-2BF	26 ⅞"	22"	90	\$918	+\$105
	1528E-2BF	26 ⅞"	28"	100	\$1002	+\$111
 2-6" box, 1-12" file, mobile, counterweights are included Mobile pedestals must be locking	1518E-2BFM	27 ½"	18"	85	\$1102	+\$112
	1522E-2BFM	27 ½"	22"	95	\$1222	+\$125
	1528E-2BFM	27 ½"	28"	105	\$1273	+\$130

9900 Series Pedestals

Freestanding, Letter Width

How to order

1. Specify product number.
2. Specify finish color.
3. Specify options.

Product code key example 1522E-2FM

- 15** pedestal width
- 22** pedestal depth
- E** 9900 Series
- 2** number of drawers
- F** 12" file drawer
- M** mobile

Pedestals are standard with either glides or casters. Exterior pedestal heights are nominal. Actual heights (with glides fully recessed) are $\frac{1}{8}$ " less. **Pedestal depths are nominal. Actual depth for 9900 Series are $\frac{3}{4}$ " more than noted.** Casters must be field installed.

Optional handle for mobile cushion pedestals, \$32 list. 27 $\frac{1}{2}$ "h mobile pedestals **do not** fit under a standard 28.5"h worksurface.

Counterweights

Counterweights are required for ALL freestanding units that are not anchored or ganged to other cabinets or bolted to walls/floor.

Counterweights are standard with all mobile pedestals and must be field installed. See [Counterweight matrix](#).

See [Pedestal Accessories](#) section for counterweight codes and pricing.

Lock option

Pedestals come standard with lock. If lock is not required add suffix '/NL' after product number. Deduct \$57 list.

Finishes

Refer to [Finishes section](#) for color options. Drawer bodies and accessories are finished in Eco Black.

Optional Accessories

All pedestal accessories are optional. See chart below for information on accessories by drawer height.

Drawer Height	Product Code	Product Description	Price
3" & 4.5"	WS-PTxx	Pencil Tray	\$37
6" & 7.5"	WS-PTxx	Pencil Tray	\$37
	WS-DVxx	Divider	\$22
18"D, 22"D, 28"D Pedestals Only (28"D requires 2 per drawer)			
10.5", 12", 13.5, & 15"	SSFxx	Side-To-Side Filing Bar	\$8

Visit the [Pedestal Accessories](#) section for full accessory details.

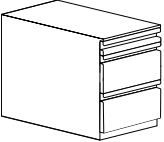
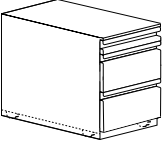
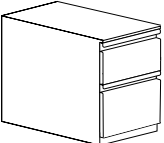
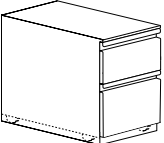
Description	Part number	Exterior Height	Case depth	Weight (lbs)	9900 series/ Neutral paint	Accent paint
 1-3" pencil, 2-10.5" file glides	1518E-P2F10.5	26 $\frac{7}{8}$ "	18"	80	\$890	+\$98
	1522E-P2F10.5	26 $\frac{7}{8}$ "	22"	90	\$930	+\$106
	1528E-P2F10.5	26 $\frac{7}{8}$ "	28"	100	\$1002	+\$111
 1-3" pencil, 2-10.5" file, mobile, counterweights are included Mobile pedestals must be locking	1518E-P2F10.5M	27 $\frac{1}{2}$ "	18"	85	\$1138	+\$116
	1522E-P2F10.5M	27 $\frac{1}{2}$ "	22"	95	\$1224	+\$126
	1528E-P2F10.5M	27 $\frac{1}{2}$ "	28"	105	\$1276	+\$130
 2-12" file glides	1518E-2F	26 $\frac{7}{8}$ "	18"	80	\$724	+\$88
	1522E-2F	26 $\frac{7}{8}$ "	22"	90	\$786	+\$94
	1528E-2F	26 $\frac{7}{8}$ "	28"	100	\$863	+\$98
 2-12" file, mobile, counterweights are included Mobile pedestals must be locking	1518E-2FM	27 $\frac{1}{2}$ "	18"	85	\$1031	+\$105
	1522E-2FM	27 $\frac{1}{2}$ "	22"	95	\$1100	+\$112
	1528E-2FM	27 $\frac{1}{2}$ "	28"	105	\$1138	+\$116

CONSIDER THIS:

At the same height get a personal drawer with your 2 file drawers!

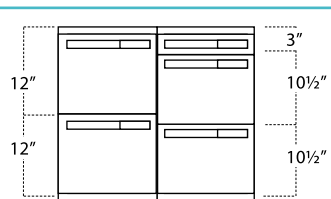

9900 Series Pedestals

Freestanding, Letter Width

How to order

1. Specify product number.
2. Specify finish color.
3. Specify options.

Product code key example 1522E-4BM

- 15** pedestal width
22 pedestal depth
E 9900 Series
4B 4 box drawers
M mobile

Pedestals are standard with either glides or casters. Exterior pedestal heights are nominal. Actual heights (with glides fully recessed) are $\frac{1}{8}$ " less. **Pedestal depths are nominal. Actual depth for 9900 Series are $\frac{3}{4}$ " more than noted.** Casters must be field installed.

Optional handle for mobile cushion pedestals, \$32 list.

Counterweights

Counterweights are required for ALL freestanding units that are not anchored or ganged to other cabinets or bolted to walls/floor.

Counterweights are standard with all mobile pedestals and must be field installed. See [Counterweight matrix](#).

See [Pedestal Accessories](#) section for counterweight codes and pricing.

Lock option

Pedestals come standard with lock. If lock is not required add suffix '/NL' after product number. Deduct \$57 list.

Finishes

Refer to [Finishes section](#) for color options. Drawer bodies and accessories are finished in Eco Black.

Optional Accessories

All pedestal accessories are optional. See chart below for information on accessories by drawer height.

Drawer Height	Product Code	Product Description	Price
3" & 4.5"	WS-PTxx	Pencil Tray	\$37
6" & 7.5"	WS-PTxx	Pencil Tray	\$37
	WS-DVxx	Divider	\$22
18"D, 22"D, 28"D Pedestals Only (28"D requires 2 per drawer)			
10.5", 12", 13.5, & 15"	SSFxx	Side-To-Side Filing Bar	\$8

Visit the [Pedestal Accessories](#) section for full accessory details.

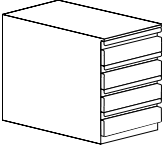
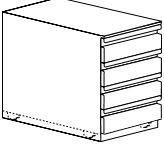
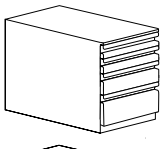
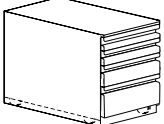
Description	Part number	Exterior Height	Case depth	Weight (lbs)	9900 series/ Neutral paint	Accent paint
 4-6" box glides	1518E-4B	26 $\frac{7}{8}$ "	18"	80	\$988	+\$101
	1522E-4B	26 $\frac{7}{8}$ "	22"	90	\$1158	+\$119
	1528E-4B	26 $\frac{7}{8}$ "	28"	100	\$1220	+\$125
 4-6" box, mobile, counterweights are included Mobile pedestals must be locking	1518E-4BM	27 $\frac{1}{2}$ "	18"	85	\$1174	+\$120
	1522E-4BM	27 $\frac{1}{2}$ "	22"	95	\$1346	+\$137
	1528E-4BM	27 $\frac{1}{2}$ "	28"	105	\$1408	+\$142
 2-3" pencil, 1-6" box, 1-12" file glides	1518E-2PBF	26 $\frac{7}{8}$ "	18"	80	\$1004	+\$103
	1522E-2PBF	26 $\frac{7}{8}$ "	22"	90	\$1125	+\$115
	1528E-2PBF	26 $\frac{7}{8}$ "	28"	100	\$1194	+\$123
 2-3" pencil, 1-6" box, 1-12" file, mobile, counterweights are included Mobile pedestals must be locking	1518E-2PBFM	27 $\frac{1}{2}$ "	18"	85	\$1194	+\$123
	1522E-2PBFM	27 $\frac{1}{2}$ "	22"	95	\$1313	+\$133
	1528E-2PBFM	27 $\frac{1}{2}$ "	28"	105	\$1380	+\$140

9900 Series Pedestals

How to order

1. Specify product number.
2. Specify finish color.
3. Specify options.

Product code key example 1522E-BFMC

- 15** pedestal width
- 22** pedestal depth
- E** 9900 Series
- B** box drawer
- F** 12" file drawer
- M** mobile
- C** cushion

Pedestal depths are nominal. Actual depth 9900 Series are 3/4" more than noted.

Mobile Cushion Pedestals have two cushion options; Classic or Lite.

The **Classic Cushion** is 1 1/4" thick CAL 117 compliant polyurethane foam with a 2.3 lb/ft. density. This upholstered cushion is balanced with a 7/16" board and is attached to the pedestal top with heavy duty Velcro. The 5-pc construction, features double row top stitching on all seams, seen in fine upholstered pieces. The result provides crisp rectilinear styling.

The **Lite Cushion** is 3/4" thick CAL 117 compliant polyurethane foam with a 2.3 lb/ft. density. This upholstered cushion is balanced with a 1/4" board and is attached to the pedestal top with Velcro. Our Lite Cushion has seamless features allowing it to highlight the fabric details. The result provides a modern and simple look. The Lite Cushion is available in the following Grade A fabrics only: Fedora, Glint, Pebble, Rancho & Script

For application of ALL fabrics, both from our graded program as well as COM (customers own material), please specify layup orientation at time of order. If layup instructions are not provided we will choose the direction to maximize our production. Refer to page 15 for additional layout and COM details.

Casters must be field installed.

Optional face-mounted contemporary style handle available for mobile cushion pedestals, \$32 list. Handle is available in two finish options: Brushed Nickel (default) or Polished Nickel.

Counterweights

Counterweights are required for ALL freestanding units that are not anchored or ganged to other cabinets or bolted to walls/floor.

Counterweights are standard with all mobile pedestals and must be field installed. See [Counterweight matrix](#).

See [Pedestal Accessories](#) section for counterweight codes and pricing.

Lock option

Pedestals come standard with lock. If lock is not required add suffix 'NL' after product number. Deduct \$57 list.

Finishes

Refer to [Finishes section](#) for color options. Drawer bodies and accessories are finished in Eco Black.

Optional Accessories



All pedestal accessories are optional. See chart below for information on accessories by drawer height.

Drawer Height	Product Code	Product Description	Price
3" & 4.5"	WS-PTxx	Pencil Tray	\$37
6" & 7.5"	WS-PTxx	Pencil Tray	\$37
	WS-DVxx	Divider	\$22

18"D, 22"D, 28"D Pedestals Only (28"D requires 2 per drawer)

Drawer Height	Product Code	Product Description	Price
10.5", 12", 13.5, & 15"	SSFxx	Side-To-Side Filing Bar	\$8

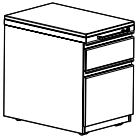
Visit the [Pedestal Accessories](#) section for full accessory details.

Description	Part number	Exterior Height	Case depth	Weight (lbs)	Classic Cushion/ Grade A/ Neutral paint/ Base price	Lite Cushion/ Grade A only/ Neutral paint	Accent paint
 Cushion pedestal 1-6" box, 1-12" file drawer, mobile, counterweights are included Mobile pedestals must be locking	1518E-BFMC	22 1/2"	18"	93	\$1002	-\$114	+\$116
	1522E-BFMC	22 1/2"	22"	105	\$1058	-\$114	+\$121
	1528E-BFMC	22 1/2"	28"	117	\$1125	-\$114	+\$126
 Cushion pedestal 1-7.5" box, 1-10.5" file drawer, mobile, counterweights are included Mobile pedestals must be locking	1518E-B7F10MC	22 1/2"	18"	93	\$1136	-\$114	+\$116
	1522E-B7F10MC	22 1/2"	22"	105	\$1180	-\$114	+\$121
	1528E-B7F10MC	22 1/2"	28"	117	\$1228	-\$114	+\$126

Fabric upcharge for mobile cushion pedestals - Classic Cushion option only

Note: To price fabric grade options, add the upcharge (+\$) in the chart below to the base price of the List price (Grade A) column. This will be the total cost for that product.

Grade B/COM	Grade C	Grade D	Grade E	Grade F
+\$57	+\$103	+\$145	+\$174	+\$249

9900 Series Pedestals

Individually Locking Drawers

How to order

1. Specify product number.
2. Specify finish color.
3. Specify options.

Product code key example 1522E-B7FM

- 15** pedestal width
22 pedestal depth
E 9900 Series
2 number of drawers
F10 10½" file drawer
TB-2 number of locking tie bar shelves

Pedestals are standard with either glides or casters. Exterior pedestal heights are nominal. Actual heights (with glides fully recessed) are ⅛" less. **Pedestal depths are nominal. Actual depth for 9900 Series are ¾" more than noted.** Casters must be field installed.

Optional handle for mobile cushion pedestals, \$32 list.

Counterweights

Counterweights are required for ALL freestanding units that are not anchored or ganged to other cabinets or bolted to walls/floor.

Counterweights are standard with all mobile pedestals and must be field installed. See [Counterweight matrix](#).

See [Pedestal Accessories](#) section for counterweight codes and pricing.

Lock option

Pedestals come standard with lock. If lock is not required add suffix '/NL' after product number. Deduct \$57 list.

Finishes

Refer to [Finishes section](#) for color options. Drawer bodies and accessories are finished in Eco Black.

Optional Accessories

All pedestal accessories are optional. See chart below for information on accessories by drawer height.

Drawer Height	Product Code	Product Description	Price
3" & 4.5"	WS-PTxx	Pencil Tray	\$37
6" & 7.5"	WS-PTxx	Pencil Tray	\$37
	WS-DVxx	Divider	\$22
18"D, 22"D, 28"D Pedestals Only (28"D requires 2 per drawer)			
10.5", 12", 13.5, & 15"	SSFxx	Side-To-Side Filing Bar	\$8

Visit the [Pedestal Accessories](#) section for full accessory details.

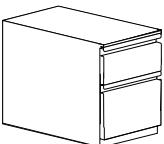
Description	Part number	Exterior Height	Case depth	Weight (lbs)	9900 series/ Neutral paint	Accent paint
 Pedestal with 2-10 ½" individual locking drawers. Locks and security shelf are included. Locks are keyed differently.	1522E-2F10TB-2	25 ¾"	22"	105	\$1257	+\$128
	1528E-2F10TB-2	25 ¾"	28"	117	\$1291	+\$131



9900 Series Laterals

US Price List • June 2021

No Match!

ANSI/BIFMA

With the addition of counterweights where appropriate, lateral files meet all ANSI/BIFMA specifications.

Construction

Lateral files and hinged door cabinets are of all-welded construction using 20 and 22 gauge high quality, tension leveled, cold rolled steel. The steel gauges selected for drawer fronts, bodies and accessories ensure the highest quality, durability and performance for all components.

Construction features & benefits

1. All interiors are modular and interchangeable so that cabinets can be retrofitted with new accessories and interiors as required.
2. Corners are strengthened with a reinforcing gusset and are welded at junction of top and case fronts, eliminating horizontal lines for a cleaner, flush appearance on the face of the cabinet.
3. Full width pulls allow lift-up doors and drawers to be opened from any position.
4. Rigid construction allows lift-up doors to be picked up and retracted smoothly from any point, eliminates deformation, ensures flush fit within the cabinet and improves lock performance.
5. Lift-up door carrier mechanism has four nylon rollers, two on each side, for smooth retracted action with no binding or snagging.
6. Front leading edge of pullout shelves is beaded and rolled to provide grip for pullout action and to strengthen shelf; front leading edge of fixed shelf is flat for easy removal of material.
7. Fully-progressive ball bearing suspensions are staged so that left and right sides work in unison. This provides smooth drawer operation with minimum force.
8. Special Claw-like device incorporated in suspensions "grips" the fixed section of the suspension arm preventing drawer bounce-back or creep when drawer is closed.
9. Lock bars operate vertically on both sides of the cabinet for maximum security.
10. Lock fingers are configured with right angle bend upward, not downward, so that lift-up doors cannot be pulled down to disengage fingers from door slots and be forced to circumvent lock system.
11. Plastic buttons in side gables of case where top sections of lift-up doors recede into the cabinet eliminate metal-to-metal contact.
12. Plastic buttons in the ends of each drawer and door front eliminates metal-to-metal contact between cabinet sides and closed drawers.
13. Self-closing, 110° opening, European style cupboard hinges provide smooth hinged door operation. Hinges are not visible from the exterior of the cabinet.

Bases

Optional base aprons are available in two heights and are screwed to the underside of the cabinet. Bases may be easily added or changed on site. Cabinets are shipped with bases installed when ordered.

Counterweights

Counterweights are required for ALL freestanding units that are not anchored or ganged to other cabinets or bolted to walls/floor.

Safelock™

The patented Safelock mechanism provides complete security against accidental opening of two or more drawers simultaneously. When any drawer or single pullout shelf is extended, even fractionally, Safelock ensures that all other openings, except for the 3" and 4½" drawers, immediately become inoperable. Safelock is standard on all lateral files. The only exceptions are the 3" and 4½" drawers and the upper shelf in a two pullout shelf opening.

Drawer Standard Equipment

Pullout drawers and shelves are standard with one pair hangfile bars for side-to-side suspended filing. Fixed shelves are standard with 3 plate dividers. Optional accessories are available.

Glides

Overall heights are inclusive of metal glides. Heights may be increased up to 5/8" by extending standard glide. Glides are accessible from inside the cabinet when the bottom drawer is fully extended or removed and may be adjusted with a 1/4" socket driver.

Optional 1½" stem glides are available. Specify and add \$30 list to the cabinet price. Requires field installation.

Locks

Cabinets come standard with lock. If lock is not required add suffix 'NL' after product number. Deduct \$57 list per lock. For lock location, see diagrams at the front of this price list.

Note: 3" and 4½" drawers, when located immediately above a case bottom, tie bar shelf or reference shelves cannot be locked.

Random keying is standard. Files may be ordered keyed alike. Locks feature removable core and are standard with two keys, one of which has a black neoprene plastic key cover.

Cabinets originally ordered as non-locking may be field installed with the addition of locking bars and a lock core. Please contact Office Specialty Client Services for required parts.

Master keys are available at \$51 list.

Lateral file tops

Refer to [Accessories section](#) to order Laminate and Nuform tops.

Finishes

Refer to [Finishes section](#) for color options. For lock finish options, refer to the front of this price list.

Drawer Pulls

9900 Series fronts have full width integral pulls with enamel finish to match case fronts.

9900 Series Laterals

No Match!
No Match!

How to order

1. Specify product number.
2. Specify finish color.
3. Specify options.

Product code key example

36-21-2FFE

- 36** cabinet width
21 interior height
2 number of drawers
FF fixed front
E 9900 Series

Exterior cabinet heights are nominal. Actual heights (with glides fully recessed) are $\frac{1}{8}$ " less. Cabinets are priced inclusive 1 pair of hangfile bars in each pullout opening and fixed shelves are standard with 3 plate dividers.

Cabinets are 18" in depth.

Counterweights

Counterweights are required for ALL freestanding units that are not anchored or ganged to other cabinets or bolted to walls/floor. See [Counterweight matrix](#).

Accessories

See [Lateral File Accessories](#) section for counterweights and accessories.

Lock option

Cabinets come standard with lock. If lock is not required add suffix '/NL' after product number. Deduct \$57 list.

Finishes

Refer to [Finishes section](#) for color options. Drawer bodies and accessories are finished in Eco Black.

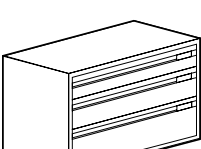
Description	Part number	Exterior Height	Width	Weight (lbs)	9900 series/ Neutral paint	Accent paint
 <p>2 high cabinet 2-10.5" fixed front drawers</p>	30-21-2FFE	23 $\frac{7}{8}$ "	30"	80	\$1058	+\$111
	36-21-2FFE	23 $\frac{7}{8}$ "	36"	98	\$1107	+\$123
	42-21-2FFE	23 $\frac{7}{8}$ "	42"	116	\$1158	+\$133
 <p>2 high cabinet 2-12" fixed front drawers</p>	24-2FFE	26 $\frac{7}{8}$ "	24"	90	\$1002	+\$104
	30-2FFE	26 $\frac{7}{8}$ "	30"	100	\$1058	+\$111
	36-2FFE	26 $\frac{7}{8}$ "	36"	120	\$1107	+\$123
	42-2FFE	26 $\frac{7}{8}$ "	42"	130	\$1158	+\$134
 <p>2 high cabinet 2-12" lift-up doors with fixed shelves</p>	30-2ETE	26 $\frac{7}{8}$ "	30"	100	\$1064	+\$108
	36-2ETE	26 $\frac{7}{8}$ "	36"	120	\$1158	+\$119
	42-2ETE	26 $\frac{7}{8}$ "	42"	130	\$1282	+\$131
 <p>2 high cabinet top opening 3" drawer, other 2 openings 10.5" fixed front drawers</p>	30-24-P2FFE	26 $\frac{7}{8}$ "	30"	100	\$1305	+\$132
	36-24-P2FFE	26 $\frac{7}{8}$ "	36"	120	\$1423	+\$144
	42-24-P2FFE	26 $\frac{7}{8}$ "	42"	130	\$1547	+\$157
 <p>2 high cabinet 1-6" drawer, 1-7.5" drawer and 1-10.5" fixed front drawer</p>	30-24-BB7FE	26 $\frac{7}{8}$ "	30"	100	\$1272	+\$130
	36-24-BB7FE	26 $\frac{7}{8}$ "	36"	120	\$1396	+\$141
	42-24-BB7FE	26 $\frac{7}{8}$ "	42"	130	\$1542	+\$157
 <p>2 high cabinet 1-4.5" drawer, 1-7.5" drawer and 1-12" fixed front drawer</p>	30-24-B4B7FE	26 $\frac{7}{8}$ "	30"	100	\$1259	+\$129
	36-24-B4B7FE	26 $\frac{7}{8}$ "	36"	120	\$1372	+\$139
	42-24-B4B7FE	26 $\frac{7}{8}$ "	42"	130	\$1491	+\$151

9900 Series Laterals

No Match!
No Match!

How to order

1. Specify product number.
2. Specify finish color.
3. Specify options.

Product code key example 36-2LUE

- 36** cabinet width
2 number of doors
LU lift-up door
E 9900 Series

All 13.5" and 15" openings for 14 7/8" x 11" EDP printouts include EDP kit for side-to-side filing of Accodata type 2 point suspension binders. Exterior cabinet heights are nominal. Actual heights (with glides fully recessed) are 7/8" less. Cabinets are priced inclusive 1 pair of hangfile bars in each pullout opening and fixed shelves are standard with 3 plate dividers.

Cabinets are 18" in depth.

Counterweights

Counterweights are required for ALL freestanding units that are not anchored or ganged to other cabinets or bolted to walls/floor. See [Counterweight matrix](#).

Accessories

See [Lateral File Accessories](#) section for counterweights and accessories.

Lock option

Cabinets come standard with lock. If lock is not required add suffix '/NL' after product number. Deduct \$57 list.

Finishes

Refer to [Finishes section](#) for color options. Drawer bodies and accessories are finished in Eco Black.

Description	Part number	Exterior Height	Width	Weight (lbs)	9900 series/ Neutral paint	Accent paint
 <p>2 high cabinet top opening 13.5" lift-up door with fixed shelf, with 3 plate dividers, other opening 10.5" fixed front drawer</p>	30-24-13LU10FE	26 7/8"	30"	100	\$1091	+\$111
	36-24-13LU10FE	26 7/8"	36"	120	\$1205	+\$124
	42-24-13LU10FE	26 7/8"	42"	130	\$1333	+\$135
 <p>2 high cabinet top opening 12" lift-up door with pullout shelf, bottom opening 12" fixed front drawer</p>	30-2LUE	26 7/8"	30"	100	\$1093	+\$111
	36-2LUE	26 7/8"	36"	120	\$1200	+\$123
	42-2LUE	26 7/8"	42"	130	\$1318	+\$134
 <p>2 high cabinet 2-13.5" fixed front EDP drawers</p>	30-27-2EDPE	29 7/8"	30"	120	\$1305	+\$132
	36-27-2EDPE	29 7/8"	36"	130	\$1401	+\$142
	42-27-2EDPE	29 7/8"	42"	150	\$1542	+\$157
 <p>2 high cabinet 2-15" fixed front EDP drawers</p>	30-30-2EDPE	32 7/8"	30"	130	\$1322	+\$134
	36-30-2EDPE	32 7/8"	36"	140	\$1446	+\$146
	42-30-2EDPE	32 7/8"	42"	160	\$1601	+\$164

9900 Series Laterals

No Match!
No Match!

How to order

1. Specify product number.
2. Specify finish color.
3. Specify options.

Product code key example 36-31.5-3FFE

- 36** cabinet width
31.5 interior height
3 number of drawers
FF fixed front
E 9900 Series

All 13.5" and 15" openings for 14 7/8" x 11" EDP printouts include EDP kit for side-to-side filing of Accodata type 2 point suspension binders. Exterior cabinet heights are nominal. Actual heights (with glides fully recessed) are 1/8" less. Cabinets are priced inclusive 1 pair of hangfile bars in each pullout opening and fixed shelves are standard with 3 plate dividers.

Cabinets are 18" in depth.

Counterweights

Counterweights are required for ALL freestanding units that are not anchored or ganged to other cabinets or bolted to walls/floor. See [Counterweight matrix](#).

Accessories

See [Lateral File Accessories](#) section for counterweights and accessories.

Lock option

Cabinets come standard with lock. If lock is not required add suffix '/NL' after product number. Deduct \$57 list.

Finishes

Refer to [Finishes section](#) for color options. Drawer bodies and accessories are finished in Eco Black.

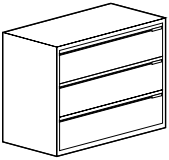
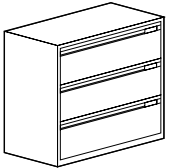
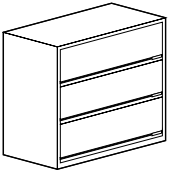
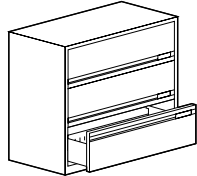
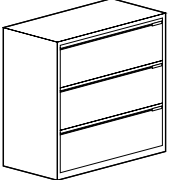
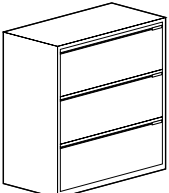
Description	Part number	Exterior Height	Width	Weight (lbs)	9900 series/ Neutral paint	Accent paint
	30-31.5-3FFE	34 3/8"	30"	120	\$1280	+\$147
	36-31.5-3FFE	34 3/8"	36"	140	\$1335	+\$165
	42-31.5-3FFE	34 3/8"	42"	160	\$1392	+\$182
	30-3FFE	38 7/8"	30"	130	\$1280	+\$148
	36-3FFE	38 7/8"	36"	150	\$1335	+\$166
	42-3FFE	38 7/8"	42"	170	\$1392	+\$184
	30-3ETE	38 7/8"	30"	130	\$1429	+\$144
	36-3ETE	38 7/8"	36"	150	\$1564	+\$160
	42-3ETE	38 7/8"	42"	170	\$1766	+\$179
	30-3LUE	38 7/8"	30"	130	\$1470	+\$148
	36-3LUE	38 7/8"	36"	150	\$1625	+\$166
	42-3LUE	38 7/8"	42"	170	\$1822	+\$184
	30-40.5-3EDPE	43 3/8"	30"	135	\$1725	+\$175
	36-40.5-3EDPE	43 3/8"	36"	155	\$1943	+\$197
	42-40.5-3EDPE	43 3/8"	42"	175	\$2167	+\$219
	30-45-3EDPE	47 7/8"	30"	145	\$1737	+\$177
	36-45-3EDPE	47 7/8"	36"	165	\$2017	+\$205
	42-45-3EDPE	47 7/8"	42"	195	\$2266	+\$228

9900 Series Laterals

Freestanding, Letter Width
Empty Field!

How to order

1. Specify product number.
2. Specify finish color.
3. Specify options.

Product code key example 36-42-4FFE

- 36** cabinet width
42 interior height
4 number of drawers
FF fixed front
E 9900 Series

Exterior cabinet heights are nominal. Actual heights (with glides fully recessed) are $\frac{1}{8}$ " less. Cabinets are priced inclusive 1 pair of hangfile bars in each pullout opening and fixed shelves are standard with 3 plate dividers.

Cabinets are 18" in depth.

Counterweights

Counterweights are required for ALL freestanding units that are not anchored or ganged to other cabinets or bolted to walls/floor. See [Counterweight matrix](#).

Accessories

See [Lateral File Accessories](#) section for counterweights and accessories.

Lock option

Cabinets come standard with lock. If lock is not required add suffix '/NL' after product number. Deduct \$57 list.

Finishes

Refer to [Finishes section](#) for color options. Drawer bodies and accessories are finished in Eco Black.

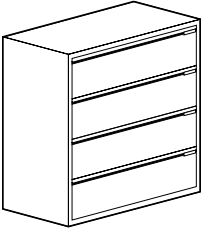
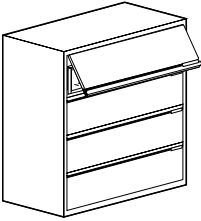
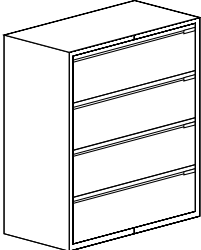
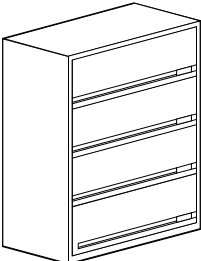
Description	Part number	Exterior Height	Width	Weight (lbs)	9900 series/ Neutral paint	Accent paint
 <p>4 high cabinet 4-10.5" fixed front drawers</p>	30-42-4FFE	44 $\frac{7}{8}$ "	30"	140	\$1558	+\$182
	36-42-4FFE	44 $\frac{7}{8}$ "	36"	160	\$1642	+\$207
	42-42-4FFE	44 $\frac{7}{8}$ "	42"	180	\$1780	+\$235
 <p>4 high cabinet top opening 12" lift-up with pullout shelf, other 3 openings 10.5" fixed front drawers</p>	30-43.5-4FFE	46 $\frac{3}{8}$ "	30"	145	\$1802	+\$182
	36-43.5-4FFE	46 $\frac{3}{8}$ "	36"	165	\$2074	+\$210
	42-43.5-4FFE	46 $\frac{3}{8}$ "	42"	185	\$2352	+\$238
 <p>4 high cabinet 4- 12" - fixed front drawers</p>	30-48-4FFE	50 $\frac{7}{8}$ "	30"	170	\$1575	+\$182
	36-48-4FFE	50 $\frac{7}{8}$ "	36"	195	\$1658	+\$212
	42-48-4FFE	50 $\frac{7}{8}$ "	42"	230	\$1798	+\$241
 <p>4 high cabinet 4-12" lift-up doors with fixed shelves</p>	30-48-4ETE	50 $\frac{7}{8}$ "	30"	170	\$1900	+\$194
	36-48-4ETE	50 $\frac{7}{8}$ "	36"	195	\$2265	+\$228
	42-48-4ETE	50 $\frac{7}{8}$ "	42"	230	\$2544	+\$256

9900 Series Laterals

No Match!
No Match!

How to order

1. Specify product number.
2. Specify finish color.
3. Specify options.

Product code key example 36-4FFE

- 36** cabinet width
4 number of drawers
FF fixed front
E 9900 Series

All 13.5" and 15" openings for 14 7/8" x 11" EDP printouts include EDP kit for side-to-side filing of Accodata type 2 point suspension binders. Exterior cabinet heights are nominal. Actual heights (with glides fully recessed) are 1/8" less. Cabinets are priced inclusive 1 pair of hangfile bars in each pullout opening and fixed shelves are standard with 3 plate dividers.

Cabinets are 18" in depth.

Counterweights

Counterweights are required for ALL freestanding units that are not anchored or ganged to other cabinets or bolted to walls/floor. See [Counterweight matrix](#).

Accessories

See [Lateral File Accessories](#) section for counterweights and accessories.

Lock option

Cabinets come standard with lock. If lock is not required add suffix '/NL' after product number. Deduct \$57 list.

Finishes

Refer to [Finishes section](#) for color options. Drawer bodies and accessories are finished in Eco Black.

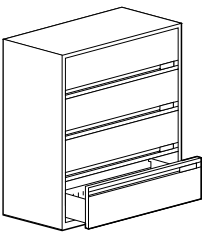
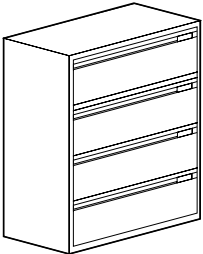
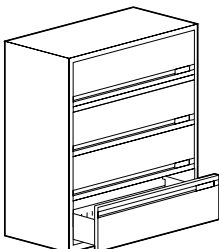
Description	Part number	Exterior Height	Width	Weight (lbs)	9900 series/ Neutral paint	Accent paint
 <p>4 high cabinet 3-12" lift-up doors with pullout shelves, bottom opening 1-12" fixed front drawer</p>	30-48-4LUE	50 7/8"	30"	175	\$2129	+\$214
	36-48-4LUE	50 7/8"	36"	200	\$2460	+\$249
	42-48-4LUE	50 7/8"	42"	235	\$2859	+\$288
 <p>4 high cabinet 4-12" fixed front drawers, 1.5" tie bar</p>	30-4FFE	52 3/8"	30"	170	\$1586	+\$184
	36-4FFE	52 3/8"	36"	195	\$1669	+\$212
	42-4FFE	52 3/8"	42"	230	\$1808	+\$241
 <p>4 high cabinet 4-12" lift-up doors with fixed shelves, 1.5" tie bar</p>	30-4ETE	52 3/8"	30"	170	\$1763	+\$179
	36-4ETE	52 3/8"	36"	195	\$2021	+\$205
	42-4ETE	52 3/8"	42"	230	\$2311	+\$234
 <p>4 high cabinet 3-12" lift-up doors with pullout shelves, bottom opening 1-12" fixed front drawer, 1.5" tie bar</p>	30-4LUE	52 3/8"	30"	170	\$1820	+\$184
	36-4LUE	52 3/8"	36"	195	\$2101	+\$212
	42-4LUE	52 3/8"	42"	230	\$2386	+\$241

9900 Series Laterals

No Match!
No Match!

How to order

1. Specify product number.
2. Specify finish color.
3. Specify options.

Product code key example 36-61.5-4EDPE

- 36** cabinet width
61.5 interior height
4 number of drawers
EDP EDP drawers
E 9900 Series

All 13.5" and 15" openings for 14 7/8" x 11" EDP printouts include EDP kit for side-to-side filing of Accodata type 2 point suspension binders. Exterior cabinet heights are nominal. Actual heights (with glides fully recessed) are 1/8" less. Cabinets are priced inclusive 1 pair of hangfile bars in each pullout opening and fixed shelves are standard with 3 plate dividers.

Cabinets are 18" in depth.

Counterweights

Counterweights are required for ALL freestanding units that are not anchored or ganged to other cabinets or bolted to walls/floor. See [Counterweight matrix](#).

Accessories

See [Lateral File Accessories](#) section for counterweights and accessories.

Lock option

Cabinets come standard with lock. If lock is not required add suffix '/NL' after product number. Deduct \$57 list.

Finishes

Refer to [Finishes section](#) for color options. Drawer bodies and accessories are finished in Eco Black.

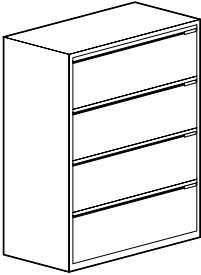
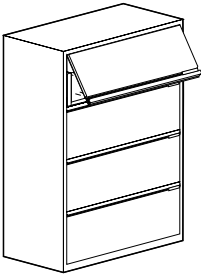
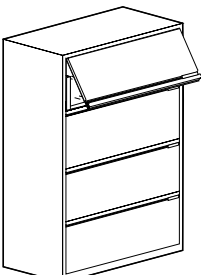
Description	Part number	Exterior Height	Width	Weight (lbs)	9900 series/ Neutral paint	Accent paint
 <p>4 high cabinet 4-13.5" fixed front EDP drawers</p>	30-54-4EDPE	56 7/8"	30"	175	\$2151	+\$216
	36-54-4EDPE	56 7/8"	36"	220	\$2448	+\$248
	42-54-4EDPE	56 7/8"	42"	250	\$2740	+\$277
 <p>4 high cabinet 4 EDP drawers, top opening 15" lift-up with pullout shelf, other 3 openings 15" fixed front drawers</p>	30-60-4EDPE	62 7/8"	30"	195	\$2159	+\$218
	36-60-4EDPE	62 7/8"	36"	230	\$2463	+\$249
	42-60-4EDPE	62 7/8"	42"	260	\$2762	+\$279
 <p>4 high cabinet 4 EDP drawers, top opening 15" lift-up with pullout shelf, bottom 3 openings 15" fixed front drawers, 1.5" tie bar</p>	30-61.5-4EDPE	64 3/8"	30"	200	\$2162	+\$218
	36-61.5-4EDPE	64 3/8"	36"	235	\$2464	+\$249
	42-61.5-4EDPE	64 3/8"	42"	265	\$2763	+\$279

9900 Series Laterals

No Match!
No Match!

How to order

1. Specify product number.
2. Specify finish color.
3. Specify options.

Product code key example

36-52.5-5FFE

36 cabinet width
52.5 interior height
5 number of drawers
FF fixed front
E 9900 Series

Exterior cabinet heights are nominal. Actual heights (with glides fully recessed) are $\frac{1}{8}$ " less. Cabinets are priced inclusive 1 pair of hangfile bars in each pullout opening and fixed shelves are standard with 3 plate dividers.

Cabinets are 18" in depth.

Counterweights

Counterweights are required for ALL freestanding units that are not anchored or ganged to other cabinets or bolted to walls/floor. See [Counterweight matrix](#).

Accessories

See [Lateral File Accessories](#) section for counterweights and accessories.

Lock option

Cabinets come standard with lock. If lock is not required add suffix '/NL' after product number. Deduct \$57 list.

Finishes

Refer to [Finishes section](#) for color options. Drawer bodies and accessories are finished in Eco Black.

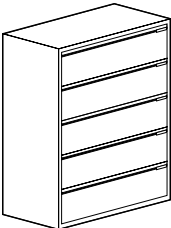
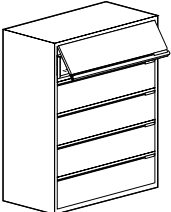
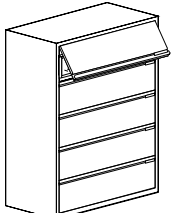
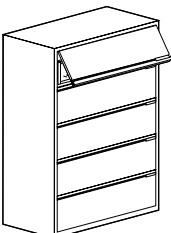
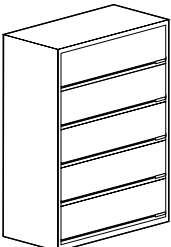
Description	Part number	Exterior Height	Width	Weight (lbs)	9900 series/ Neutral paint	Accent paint
 <p>5 high cabinet 5-10.5" fixed front drawers</p>	30-52.5-5FFE	55 $\frac{3}{8}$ "	30"	180	\$1753	+\$214
	36-52.5-5FFE	55 $\frac{3}{8}$ "	36"	205	\$1836	+\$247
	42-52.5-5FFE	55 $\frac{3}{8}$ "	42"	240	\$1920	+\$279
 <p>5 high cabinet top opening 12" lift-up with pullout shelf, other 4 openings 10.5" fixed front drawers</p>	30-54-5FFE	56 $\frac{7}{8}$ "	30"	185	\$2142	+\$215
	36-54-5FFE	56 $\frac{7}{8}$ "	36"	210	\$2441	+\$247
	42-54-5FFE	56 $\frac{7}{8}$ "	42"	245	\$2773	+\$280
 <p>5 high cabinet top opening 13.5" lift-up with fixed shelf, other 4 openings 10.5" fixed front drawers</p>	30-55.5-5FFE	58 $\frac{3}{8}$ "	30"	185	\$2139	+\$215
	36-55.5-5FFE	58 $\frac{3}{8}$ "	36"	210	\$2456	+\$248
	42-55.5-5FFE	58 $\frac{3}{8}$ "	42"	245	\$2800	+\$282
 <p>5 high cabinet top opening 12" lift-up with pullout shelf, other 4 openings 12" fixed front drawers</p>	30-60-5FFE	62 $\frac{7}{8}$ "	30"	195	\$1853	+\$216
	36-60-5FFE	62 $\frac{7}{8}$ "	36"	230	\$1937	+\$249
	42-60-5FFE	62 $\frac{7}{8}$ "	42"	260	\$2020	+\$282
 <p>5 high cabinet 5-12" lift-up doors with fixed shelves</p>	30-60-5ETE	62 $\frac{7}{8}$ "	30"	195	\$2076	+\$210
	36-60-5ETE	62 $\frac{7}{8}$ "	36"	230	\$2359	+\$239
	42-60-5ETE	62 $\frac{7}{8}$ "	42"	260	\$2699	+\$273

9900 Series Laterals

No Match!
No Match!

How to order

1. Specify product number.
2. Specify finish color.
3. Specify options.

Product code key example 36-60-5LUE

- 36** cabinet width
60 interior height
5 number of doors
LU lift-up door
E 9900 Series

Exterior cabinet heights are nominal. Actual heights (with glides fully recessed) are $\frac{1}{8}$ " less. Cabinets are priced inclusive 1 pair of hangfile bars in each pullout opening and fixed shelves are standard with 3 plate dividers.

Cabinets are 18" in depth.

Counterweights

Counterweights are required for ALL freestanding units that are not anchored or ganged to other cabinets or bolted to walls/floor. See [Counterweight matrix](#).

Accessories

See [Lateral File Accessories](#) section for counterweights and accessories.

Lock option

Cabinets come standard with lock. If lock is not required add suffix '/NL' after product number. Deduct \$57 list.

Finishes

Refer to [Finishes section](#) for color options. Drawer bodies and accessories are finished in Eco Black.

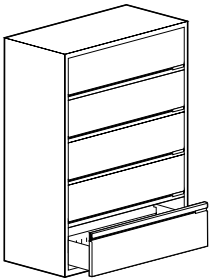
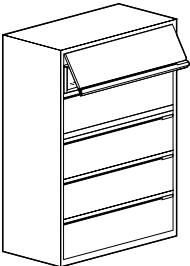
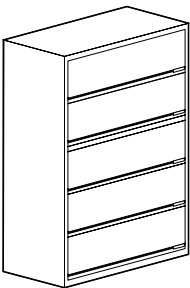
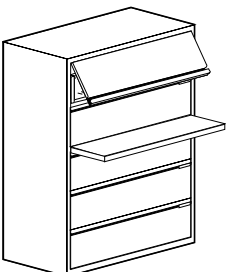
Description	Part number	Exterior Height	Width	Weight (lbs)	9900 series/ Neutral paint	Accent paint
 <p>5 high cabinet 4-12" lift-up doors with pullout shelves, bottom opening 1-12" fixed front drawer</p>	30-60-5LUE	62 $\frac{7}{8}$ "	30"	195	\$2149	+\$216
	36-60-5LUE	62 $\frac{7}{8}$ "	36"	230	\$2460	+\$249
	42-60-5LUE	62 $\frac{7}{8}$ "	42"	260	\$2797	+\$282
 <p>5 high cabinet top opening 12" lift-up with pullout shelf, other 4 openings 12" fixed front drawers, 1.5" tie bar</p>	30-5FFE	64 $\frac{3}{8}$ "	30"	200	\$1859	+\$216
	36-5FFE	64 $\frac{3}{8}$ "	36"	235	\$1948	+\$249
	42-5FFE	64 $\frac{3}{8}$ "	42"	265	\$2031	+\$282
 <p>5 high cabinet 5-12" lift-up doors with fixed shelves, 1.5" tie bar</p>	30-5ETE	64 $\frac{3}{8}$ "	30"	200	\$2078	+\$210
	36-5ETE	64 $\frac{3}{8}$ "	36"	235	\$2361	+\$239
	42-5ETE	64 $\frac{3}{8}$ "	42"	265	\$2700	+\$274
 <p>5 high cabinet top opening 12" lift-up with pullout shelf, other 4 openings 12" fixed front drawers, 1.5" reference shelf</p>	30-5FFE-RF	64 $\frac{3}{8}$ "	30"	200	\$1997	+\$231
	36-5FFE-RF	64 $\frac{3}{8}$ "	36"	235	\$2092	+\$263
	42-5FFE-RF	64 $\frac{3}{8}$ "	42"	265	\$2237	+\$295

9900 Series Laterals

No Match!
No Match!

How to order

1. Specify product number.
2. Specify finish color.
3. Specify options.

Product code key example 36-61.5-LU4FFE

36 cabinet width
61.5 interior height
LU lift-up door
4 number of drawers
FF fixed front
E 9900 Series

All 13.5" and 15" openings for 14 7/8" x 11" EDP printouts include EDP kit for side-to-side filing of Accodata type 2 point suspension binders. Exterior cabinet heights are nominal. Actual heights (with glides fully recessed) are 1/8" less. Cabinets are priced inclusive 1 pair of hangfile bars in each pullout opening and fixed shelves are standard with 3 plate dividers.

Cabinets are 18" in depth.

Counterweights

Counterweights are required for ALL freestanding units that are not anchored or ganged to other cabinets or bolted to walls/floor. See [Counterweight matrix](#).

Accessories

See [Lateral File Accessories](#) section for counterweights and accessories.

Lock option

Cabinets come standard with lock. If lock is not required add suffix '/NL' after product number. Deduct \$57 list.

Finishes

Refer to [Finishes section](#) for color options. Drawer bodies and accessories are finished in Eco Black.

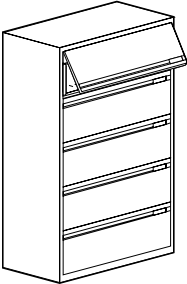
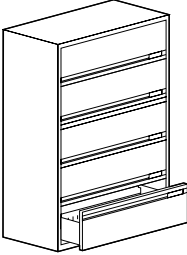
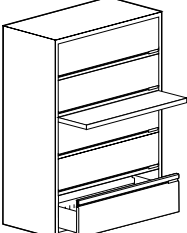
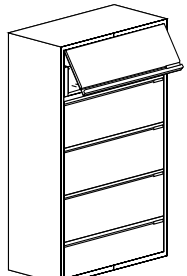
Description	Part number	Exterior Height	Width	Weight (lbs)	9900 series/ Neutral paint	Accent paint
 <p>5 high cabinet top opening 13.5" liftup with fixed shelf and 3 plate dividers, other 4 openings 12" fixed front drawers.</p>	30-615-LU4FFE	64 3/8"	30"	200	\$2059	+\$216
	36-615-LU4FFE	64 3/8"	36"	235	\$2114	+\$249
	42-615-LU4FFE	64 3/8"	42"	265	\$2337	+\$283
 <p>5 high cabinet 4-12" lift-up doors with pullout shelves, bottom opening 1-12" fixed front drawer, 1.5" tie bar</p>	30-5LUE	64 3/8"	30"	200	\$2151	+\$216
	36-5LUE	64 3/8"	36"	235	\$2461	+\$249
	42-5LUE	64 3/8"	42"	265	\$2798	+\$282
 <p>5 high cabinet 4-12", lift-up doors with pullout shelves, bottom opening 1-12" fixed front drawer, 1.5" reference shelf</p>	30-5LUE-RF	64 3/8"	30"	200	\$2288	+\$231
	36-5LUE-RF	64 3/8"	36"	235	\$2601	+\$263
	42-5LUE-RF	64 3/8"	42"	265	\$2938	+\$295
 <p>5 high cabinet 5 EDP drawers, top opening 15" lift-up with pullout shelf, other 4 openings 13.5" fixed front EDP drawers, 1.5" tie bar</p>	30-70.5-5EDPE	73 3/8"	30"	210	\$2665	+\$268
	36-70.5-5EDPE	73 3/8"	36"	245	\$3043	+\$306
	42-70.5-5EDPE	73 3/8"	42"	275	\$3378	+\$341

9900 Series Laterals

No Match!
No Match!

How to order

1. Specify product number.
2. Specify finish color.
3. Specify options.

Product code key example 36-45-6B7E

- 36** cabinet width
45 interior height
6 number of drawers
B7 7 1/2" box drawer
E 9900 Series

Exterior cabinet heights are nominal. Actual heights (with glides fully recessed) are 1/8" less. Cabinets are priced inclusive of 1 pair of hangfile bars in each pullout opening and fixed shelves are standard with 3 plate dividers. 7.5" box drawers come with 3 dividers in 30" wide drawers, 4 dividers in 36" wide drawers and 5 dividers in 42" wide drawers.

Cabinets are 18" in depth.

Counterweights

Counterweights are required for ALL freestanding units that are not anchored or ganged to other cabinets or bolted to walls/floor. See [Counterweight matrix](#).

Accessories

See [Lateral File Accessories](#) section for counterweights and accessories.

Lock option

Cabinets come standard with lock. If lock is not required add suffix '/NL' after product number. Deduct \$57 list.

Finishes

Refer to [Finishes section](#) for color options. Drawer bodies and accessories are finished in Eco Black.

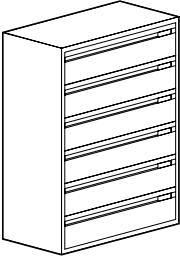
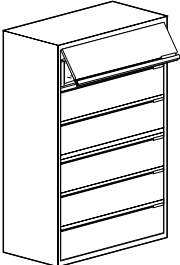
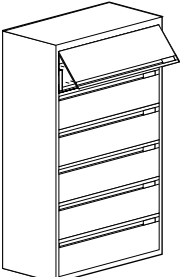
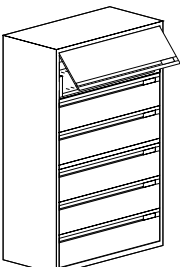
Description	Part number	Exterior Height	Width	Weight (lbs)	9900 series/ Neutral paint	Accent paint
 <p>6 high cabinet 6-7.5" drawers with accessories</p>	30-45-6B7E	47 7/8"	30"	154	\$2480	+\$251
	36-45-6B7E	47 7/8"	36"	197	\$2896	+\$291
	42-45-6B7E	47 7/8"	42"	223	\$3333	+\$336
 <p>6 high cabinet top opening 12" lift-up with pullout shelf, other 5 openings 10.5" fixed front drawers, 1.5" tie bar</p>	30-66-6FFE	68 7/8"	30"	215	\$2505	+\$253
	36-66-6FFE	68 7/8"	36"	230	\$2868	+\$289
	42-66-6FFE	68 7/8"	42"	260	\$3236	+\$327
 <p>6 high cabinet top opening 13.5" lift-up with fixed shelf, other 5 openings 10.5" fixed front drawers</p>	30-66-LU5F10E	68 7/8"	30"	215	\$2501	+\$252
	36-66-LU5F10E	68 7/8"	36"	230	\$2878	+\$290
	42-66-LU5F10E	68 7/8"	42"	260	\$3250	+\$328
 <p>6 high cabinet top opening 13.5" liftup with fixed shelf and 3 plate dividers, other 5 openings 10.5" fixed front drawers, 1.5" tie bar</p>	30-67.5-6FFE	70 3/8"	30"	245	\$2529	+\$255
	36-67.5-6FFE	70 3/8"	36"	265	\$2899	+\$292
	42-67.5-6FFE	70 3/8"	42"	285	\$3279	+\$330

9900 Series Laterals

No Match!
No Match!

How to order

1. Specify product number.
2. Specify finish color.
3. Specify options.

Product code key example 30-70.5-2LU4F10E

- 30** cabinet width
70.5 interior height
2LU number of lift-up doors
4 number of drawers
F10 10.5" h file drawers
E 9900 Series

Exterior cabinet heights are nominal. Actual heights (with glides fully recessed) are $\frac{1}{8}$ " less. Cabinets are priced inclusive 1 pair of hangfile bars in each pullout opening and fixed shelves are standard with 3 plate dividers.

Cabinets are 18" in depth.

Counterweights

Counterweights are required for ALL freestanding units that are not anchored or ganged to other cabinets or bolted to walls/floor. See [Counterweight matrix](#).

Accessories

See [Lateral File Accessories](#) section for counterweights and accessories.

Lock option

Cabinets come standard with lock. If lock is not required add suffix '/NL' after product number. Deduct \$57 list.

Finishes

Refer to [Finishes section](#) for color options. Drawer bodies and accessories are finished in Eco Black.

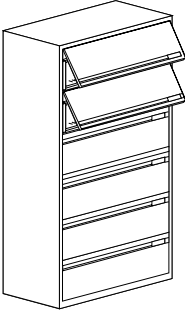
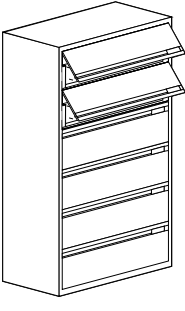
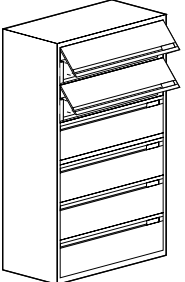
Description	Part number	Exterior Height	Width	Weight (lbs)	9900 series/ Neutral paint	Accent paint
 <p>6 high cabinet top 2 openings 13.5" lift-up with fixed shelf and 3 plate dividers, other 4 openings 10.5" fixed front drawers, 1.5" tie bar</p>	30-705-2LU4F10E	73 $\frac{3}{8}$ "	30"	232	\$2573	+\$259
	36-705-2LU4F10E	73 $\frac{3}{8}$ "	36"	260	\$2966	+\$299
	42-705-2LU4F10E	73 $\frac{3}{8}$ "	42"	302	\$3356	+\$339
 <p>6 high cabinet top opening 12" lift-up with fixed shelf and 3 plate dividers, next opening 12" lift-up with pullout shelf and hangfile bars, other 4 openings 12" fixed front doors</p>	30-72-6FFE	74 $\frac{7}{8}$ "	30"	250	\$2601	+\$263
	36-72-6FFE	74 $\frac{7}{8}$ "	36"	270	\$2972	+\$300
	42-72-6FFE	74 $\frac{7}{8}$ "	42"	291	\$3407	+\$343
 <p>6 high cabinet top opening 12" lift-up with fixed shelf and 3 plate dividers, next opening 12" lift-up with pullout shelf and hangfile bars, other 4 openings 12" fixed front drawers, 1.5" tie bar</p>	30-6FFE	76 $\frac{3}{8}$ "	30"	250	\$2619	+\$265
	36-6FFE	76 $\frac{3}{8}$ "	36"	270	\$2994	+\$302
	42-6FFE	76 $\frac{3}{8}$ "	42"	291	\$3374	+\$340

9900 Series Laterals

No Match!
No Match!

How to order

1. Specify product number.
2. Specify finish color.
3. Specify options.

Product code key example

36-6FFE-RF

- 36** cabinet width
6 number of drawers
FF fixed front
E 9900 Series
RF 1.5" reference shelf

Exterior cabinet heights are nominal. Actual heights (with glides fully recessed) are $\frac{1}{8}$ " less. Cabinets are priced inclusive 1 pair of hangfile bars in each pullout opening and fixed shelves are standard with 3 plate dividers.

Cabinets are 18" in depth.

Counterweights

Counterweights are required for ALL freestanding units that are not anchored or ganged to other cabinets or bolted to walls/floor. See [Counterweight matrix](#).

Accessories

See [Lateral File Accessories](#) section for counterweights and accessories.

Lock option

Cabinets come standard with lock. If lock is not required add suffix '/NL' after product number. Deduct \$57 list.

Finishes

Refer to [Finishes section](#) for color options. Drawer bodies and accessories are finished in Eco Black.

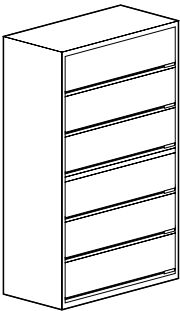
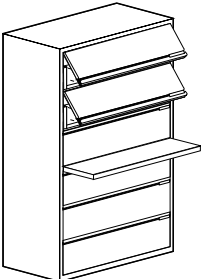
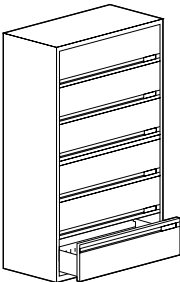
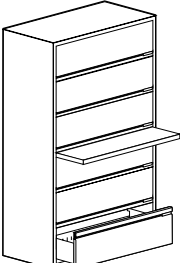
Description	Part number	Exterior Height	Width	Weight (lbs)	9900 series/ Neutral paint	Accent paint
 <p>6 high cabinet 6-12" lift-up doors with fixed shelves, 1.5" tie bar</p>	30-6ETE	76 $\frac{3}{8}$ "	30"	250	\$2547	+\$256
	36-6ETE	76 $\frac{3}{8}$ "	36"	270	\$2895	+\$291
	42-6ETE	76 $\frac{3}{8}$ "	42"	291	\$3283	+\$331
 <p>6 high cabinet top opening 12" lift-up with fixed shelf and 3 plate dividers, next opening 12" lift-up with pullout shelf and hangfile bars, other 4 openings 12" fixed front drawers, 1.5" reference shelf</p>	30-6FFE-RF	76 $\frac{3}{8}$ "	30"	250	\$2758	+\$278
	36-6FFE-RF	76 $\frac{3}{8}$ "	36"	270	\$3137	+\$317
	42-6FFE-RF	76 $\frac{3}{8}$ "	42"	291	\$3518	+\$355
 <p>6 high cabinet top opening 12" lift-up door with fixed shelf and 3 plate dividers, other 4 openings 12" lift-up doors with pullout shelves, bottom opening 12" fixed front drawer, 1.5" tie bar</p>	30-6LUE	76 $\frac{3}{8}$ "	30"	250	\$2619	+\$265
	36-6LUE	76 $\frac{3}{8}$ "	36"	270	\$2994	+\$302
	42-6LUE	76 $\frac{3}{8}$ "	42"	291	\$3374	+\$340
 <p>6 high cabinet top opening 12" lift-up door with fixed shelf and 3 plate dividers, other 4 openings 12" lift-up doors with pullout shelves, bottom opening 12" fixed front drawer, 1.5" reference shelf</p>	30-6LUE-RF	76 $\frac{3}{8}$ "	30"	250	\$2758	+\$278
	36-6LUE-RF	76 $\frac{3}{8}$ "	36"	270	\$3137	+\$317
	42-6LUE-RF	76 $\frac{3}{8}$ "	42"	291	\$3518	+\$355

9900 Series Laterals

No Match!
No Match!

How to order

1. Specify product number.
2. Specify finish color.
3. Specify options.

Product code key example 36-75-6FFE

- 36** cabinet width
75 interior height
6 number of drawers
FF fixed front
E 9900 Series

Exterior cabinet heights are nominal. Actual heights (with glides fully recessed) are $\frac{1}{8}$ " less. Cabinets are priced inclusive 1 pair of hangfile bars in each pullout opening and fixed shelves are standard with 3 plate dividers.

Cabinets are 18" in depth.

Counterweights

Counterweights are required for ALL freestanding units that are not anchored or ganged to other cabinets or bolted to walls/floor. See [Counterweight matrix](#).

Accessories

See [Lateral File Accessories](#) section for counterweights and accessories.

Lock option

Cabinets come standard with lock. If lock is not required add suffix '/NL' after product number. Deduct \$57 list.

Finishes

Refer to [Finishes section](#) for color options. Drawer bodies and accessories are finished in Eco Black.

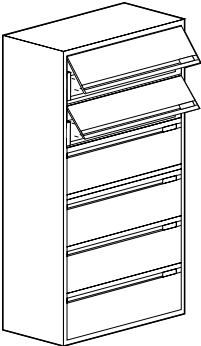
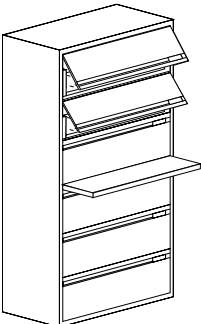
Description	Part number	Exterior Height	Width	Weight (lbs)	9900 series/ Neutral paint	Accent paint
 <p>6 high cabinet top opening 13.5" lift-up with fixed shelf and 3 plate dividers, next opening 12" lift-up with pullout shelf and hangfile bars, other 4 openings 12" fixed front drawers, 1.5" tie bar</p>	30-75-6FFE	77 $\frac{7}{8}$ "	30"	257	\$2668	+\$270
	36-75-6FFE	77 $\frac{7}{8}$ "	36"	277	\$3055	+\$308
	42-75-6FFE	77 $\frac{7}{8}$ "	42"	299	\$3438	+\$347
 <p>6 high cabinet top opening 13.5" liftup with fixed shelf and 3 plate dividers, next opening 12" lift-up with pullout shelf and hangfile bars, other 4 openings 12" fixed front drawers, 1.5" reference shelf</p>	30-75-6FFE-RF	77 $\frac{7}{8}$ "	30"	257	\$2806	+\$283
	36-75-6FFE-RF	77 $\frac{7}{8}$ "	36"	277	\$3195	+\$322
	42-75-6FFE-RF	77 $\frac{7}{8}$ "	42"	299	\$3583	+\$360

9900 Series Laterals

No Match!
No Match!

How to order

1. Specify product number.
2. Specify finish color.
3. Specify options.

Product code key example 36-52.5-7B7E

- 36** cabinet width
52.5 interior height
7 number of drawers
B7 7.5" box drawer
E 9900 Series

Exterior cabinet heights are nominal. Actual heights (with glides fully recessed) are $\frac{1}{8}$ " less. Cabinets are priced inclusive of 1 pair of hangfile bars in each pullout opening and fixed shelves are standard with 3 plate dividers. 7.5" box drawers come with 3 dividers in 30" wide drawers, 4 dividers in 36" wide drawers and 5 dividers in 42" wide drawers.

Cabinets are 18" in depth.

Counterweights

Counterweights are required for ALL freestanding units that are not anchored or ganged to other cabinets or bolted to walls/floor. See [Counterweight matrix](#).

Accessories

See [Lateral File Accessories](#) section for counterweights and accessories.

Lock option

Cabinets come standard with lock. If lock is not required add suffix **'/NL'** after product number. Deduct \$57 list.

Finishes

Refer to [Finishes section](#) for color options. Drawer bodies and accessories are finished in Eco Black.

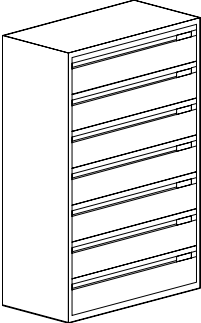
Description	Part number	Exterior Height	Width	Weight (lbs)	9900 series/ Neutral paint	Accent paint
 <p>7 high cabinet 7- 7.5" drawers with accessories</p>	30-52.5-7B7E	55 $\frac{3}{8}$ "	30"	170	\$2827	+\$285
	36-52.5-7B7E	55 $\frac{3}{8}$ "	36"	219	\$3261	+\$329
	42-52.5-7B7E	55 $\frac{3}{8}$ "	42"	247	\$3758	+\$377

9900 Series Laterals

No Match!
No Match!

How to order

1. Specify product number.
2. Specify finish color.
3. Specify options.

Product code key example 36-60-8B7E

- 36** cabinet width
60 interior height
8 number of drawers
B7 7.5" box drawer
E 9900 Series

Exterior cabinet heights are nominal. Actual heights (with glides fully recessed) are $\frac{1}{8}$ " less. Cabinets are priced inclusive of 1 pair of hangfile bars in each pullout opening and fixed shelves are standard with 3 plate dividers. 7.5" box drawers come with 3 dividers in 30" wide drawers, 4 dividers in 36" wide drawers and 5 dividers in 42" wide drawers.

Cabinets are 18" in depth.

Counterweights

Counterweights are required for ALL freestanding units that are not anchored or ganged to other cabinets or bolted to walls/floor. See [Counterweight matrix](#).

Accessories

See [Lateral File Accessories](#) section for counterweights and accessories.

Lock option

Cabinets come standard with lock. If lock is not required add suffix '/NL' after product number. Deduct \$57 list.

Finishes

Refer to [Finishes section](#) for color options. Drawer bodies and accessories are finished in Eco Black.

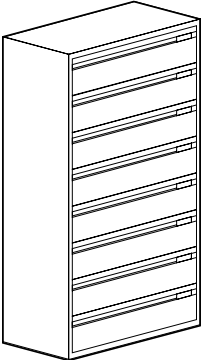
Description	Part number	Exterior Height	Width	Weight (lbs)	9900 series/ Neutral paint	Accent paint
 8 high cabinet 8- 7.5" drawers with accessories	30-60-8B7E	62 $\frac{7}{8}$ "	30"	186	\$3154	+\$318
	36-60-8B7E	62 $\frac{7}{8}$ "	36"	241	\$3634	+\$366
	42-60-8B7E	62 $\frac{7}{8}$ "	42"	271	\$4183	+\$421

9900 Series Laterals

No Match!
No Match!

How to order

1. Specify product number.
2. Specify finish color.
3. Specify options.

Product code key example 36225-2FFE1TB

- 36** cabinet width
225 interior height
2 number of drawers
FF fixed front
E 9900 Series
1TB number of locking tier bars

Exterior cabinet heights are nominal. Actual heights (with glides fully recessed) are $\frac{1}{8}$ " less. Cabinets are priced inclusive 1 pair of hangfile bars in each pullout opening and fixed shelves are standard with 3 plate dividers.

Cabinets are 18" in depth.

Counterweights

Counterweights are required for ALL freestanding units that are not anchored or ganged to other cabinets or bolted to walls/floor. See [Counterweight matrix](#).

Accessories

See [Lateral File Accessories](#) section for counterweights and accessories.

Lock option

Cabinets come standard with lock. If lock is not required add suffix '/NL' after product number. Deduct \$57 list.

Finishes

Refer to [Finishes section](#) for color options. Drawer bodies and accessories are finished in Eco Black.

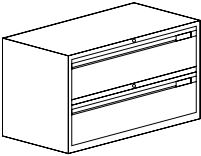
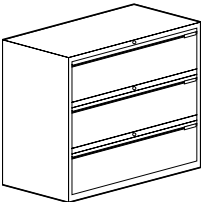
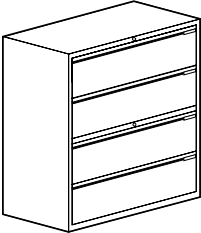
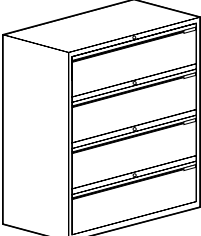
Description	Part number	Exterior Height	Width	Weight (lbs)	9900 series/ Neutral paint	Accent paint
 <p>2 high cabinet 2-10.5" fixed front individually locking drawers</p>	30225-2FFE1TB	25 $\frac{3}{8}$ "	30"	90	\$1240	+\$127
	36225-2FFE1TB	25 $\frac{3}{8}$ "	36"	105	\$1380	+\$140
	42225-2FFE1TB	25 $\frac{3}{8}$ "	42"	120	\$1491	+\$151
 <p>3 high cabinet 3-10.5" fixed front individually locking drawers</p>	30345-3FFE2TB	37 $\frac{3}{8}$ "	30"	130	\$1809	+\$183
	36345-3FFE2TB	37 $\frac{3}{8}$ "	36"	150	\$1987	+\$201
	42345-3FFE2TB	37 $\frac{3}{8}$ "	42"	170	\$2180	+\$220
 <p>4 high cabinet 4-10.5" fixed front drawers. Top two drawers share one lock, bottom two drawers share another lock.</p>	30435-4FFE1TB	46 $\frac{3}{8}$ "	30"	145	\$1952	+\$198
	36435-4FFE1TB	46 $\frac{3}{8}$ "	36"	165	\$2233	+\$225
	42435-4FFE1TB	46 $\frac{3}{8}$ "	42"	185	\$2506	+\$253
 <p>4 high cabinet 4-10.5" fixed front individually locking drawers</p>	30465-4FFE3TB	49 $\frac{3}{8}$ "	30"	180	\$2366	+\$240
	36465-4FFE3TB	49 $\frac{3}{8}$ "	36"	205	\$2657	+\$268
	42465-4FFE3TB	49 $\frac{3}{8}$ "	42"	240	\$2935	+\$295

9900 Series Laterals

No Match!
No Match!

How to order

1. Specify product number.
2. Specify finish color.
3. Specify options.

Product code key example

3660-5FFE4TB

- 36** cabinet width
60 interior height
5 number of drawers
FF fixed front
E 9900 Series
4TB number of locking tier bars

Exterior cabinet heights are nominal. Actual heights (with glides fully recessed) are $\frac{1}{8}$ " less. Cabinets are priced inclusive 1 pair of hangfile bars in each pullout opening and fixed shelves are standard with 3 plate dividers.

Cabinets are 18" in depth.

Counterweights

Counterweights are required for ALL freestanding units that are not anchored or ganged to other cabinets or bolted to walls/floor. See [Counterweight matrix](#).

Accessories

See [Lateral File Accessories](#) section for counterweights and accessories.

Lock option

Cabinets come standard with lock. If lock is not required add suffix '/NL' after product number. Deduct \$57 list.

Finishes

Refer to [Finishes section](#) for color options. Drawer bodies and accessories are finished in Eco Black.

Description	Part number	Exterior Height	Width	Weight (lbs)	9900 series/ Neutral paint	Accent point
 <p>5 high cabinet 5-10.5" fixed front individually locking drawers</p>	30585-5FFE4TB	61 $\frac{3}{8}$ "	30"	195	\$2915	+\$293
	36585-5FFE4TB	61 $\frac{3}{8}$ "	36"	230	\$3211	+\$323
	42585-5FFE4TB	61 $\frac{3}{8}$ "	42"	260	\$3535	+\$356
 <p>Cabinet from top to bottom: 1-12" lift-up door with pullout shelf, 1-10.5" fixed front drawer, 2-6" fixed front drawers, 10.5" fixed front drawer and 1-12" fixed front drawer. Each bank of 3 drawers locks individually.</p>	305812LU5FFETB	61 $\frac{3}{8}$ "	30"	235	\$2516	+\$254
	365812LU5FFETB	61 $\frac{3}{8}$ "	36"	240	\$2835	+\$286
	425812LU5FFETB	61 $\frac{3}{8}$ "	42"	270	\$3174	+\$320
 <p>5 high cabinet top opening 12" lift-up with pullout shelf, other 4 openings 10 $\frac{1}{2}$" fixed front individually locking drawers</p>	3060-5FFE4TB	62 $\frac{7}{8}$ "	30"	195	\$2915	+\$293
	3660-5FFE4TB	62 $\frac{7}{8}$ "	36"	230	\$3211	+\$323
	4260-5FFE4TB	62 $\frac{7}{8}$ "	42"	260	\$3535	+\$356

9900 Series Laterals

No Match!
No Match!

How to order

1. Specify product number.
2. Specify finish color.
3. Specify options.

Product code key example

36-2FFE-SB

- 36** cabinet width
2 number of drawers
FF fixed front
E 9900 Series
SB sliding security bar

Secure Files you get added security from two 'piano-style' hinges welded on both sides of the case. These hinges cover the drawers and are held in place by a sliding security bar with provision for a padlock

Exterior cabinet heights are nominal. Actual heights (with glides fully recessed) are $\frac{1}{8}$ " less. Cabinets come with piano style hinges, a $1\frac{1}{2}$ " sliding security bar and a lock hook with double sided tape. Cabinets are priced inclusive 1 pair of hangfile bars in each pullout opening.

Cabinets are 18" in depth.

Counterweights

Counterweights are required for ALL freestanding units that are not anchored or ganged to other cabinets or bolted to walls/floor. See [Counterweight matrix](#).

Accessories

See [Lateral File Accessories](#) section for counterweights and accessories.

Lock option

Cabinets come standard with lock. If lock is not required add suffix '/NL' after product number. Deduct \$57 list.

Finishes

Refer to [Finishes section](#) for color options. Drawer bodies and accessories are finished in Eco Black.

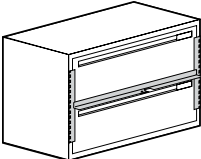
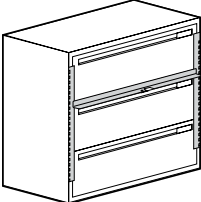
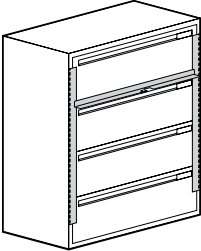
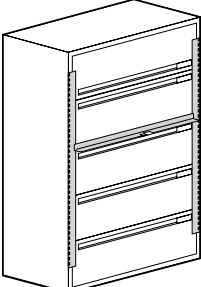
	Description	Part number	Exterior Height	Width	Weight (lbs)	9900 series/ Neutral paint	Accent paint
	2 high cabinet	30-2FFE-SB	28 $\frac{3}{8}$ "	30"	107	\$1447	+\$146
	2-12" fixed front drawers, 1.5" sliding security bar	36-2FFE-SB	28 $\frac{3}{8}$ "	36"	127	\$1519	+\$154
		42-2FFE-SB	28 $\frac{3}{8}$ "	42"	138	\$1646	+\$168
	3 high cabinet	30-3FFE-SB	40 $\frac{3}{8}$ "	30"	139	\$1825	+\$184
	3-12" fixed front drawers, 1.5" sliding security bar	36-3FFE-SB	40 $\frac{3}{8}$ "	36"	159	\$1986	+\$201
		42-3FFE-SB	40 $\frac{3}{8}$ "	42"	181	\$2197	+\$221
	4 high cabinet	30-4FFE-SB	52 $\frac{3}{8}$ "	30"	180	\$2193	+\$221
	4-12" fixed front drawers, 1.5" sliding security bar	36-4FFE-SB	52 $\frac{3}{8}$ "	36"	205	\$2473	+\$250
		42-4FFE-SB	52 $\frac{3}{8}$ "	42"	241	\$2760	+\$279
	5 high cabinet	30-5FFE-SB	64 $\frac{3}{8}$ "	30"	212	\$2550	+\$258
	top opening 12" lift-up with pullout shelf, other 4 openings 12" fixed front drawers, 1.5" sliding security bar	36-5FFE-SB	64 $\frac{3}{8}$ "	36"	247	\$2861	+\$288
		42-5FFE-SB	64 $\frac{3}{8}$ "	42"	274	\$3197	+\$322

9900 Series Laterals

Freestanding, Letter Width
Empty Field!

How to order

1. Specify product number.
2. Specify finish color.
3. Specify options.

Product code key example 3624E-F-R2B

36 cabinet width
24 interior height
E 9900 Series
F 12" file drawer
R right side
2B 6" box drawers

Exterior cabinet heights are nominal. Actual heights (with glides fully recessed) are $\frac{1}{8}$ " less. Cabinets are priced inclusive 1 pair of hangfile bars in each pullout opening and fixed shelves are standard with 3 plate dividers.

Cabinets are 18" in depth.

Counterweights

Counterweights are required for ALL freestanding units that are not anchored or ganged to other cabinets or bolted to walls/floor. See [Counterweight matrix](#).

Accessories

See [Lateral File Accessories](#) section for counterweights and accessories.

Lock option

Cabinets come standard with lock. If lock is not required add suffix '/NL' after product number. Deduct \$57 list.

Finishes

Refer to [Finishes section](#) for color options. Drawer bodies and accessories are finished in Eco Black.

	Description	Part number	Exterior Height	Width	Weight (lbs)	9900 series/ Neutral paint	Accent paint
	1-10.5" h x 15" w file drawer 1-3" h x 15" w pencil drawer 1-7.5" h x 15" w box drawer 1-10.5" h x 30" W file drawer Counterweight included Left hand unit must be specified under worksurface	30225E-F10LPB7	25 $\frac{3}{8}$ "	30"	117	\$1421	+\$143
	1-10.5" h x 15" w file drawer 1-3" h x 15" w pencil drawer 1-7.5" h x 15" w box drawer 1-10.5" h x 30" W file drawer Counterweight included	30225E-F10RPB7	25 $\frac{3}{8}$ "	30"	117	\$1421	+\$143
	1-12" h x 15" w file drawer 2-6" h x 15" w box drawers 1-10.5" h x 30" w file drawer Counterweight included Left hand unit must be specified under worksurface	3024E-F-L2B	26 $\frac{7}{8}$ "	30"	117	\$1440	+\$145
	1-12" h x 15" w file drawer 2-6" h x 15" w box drawers 1-10.5" h x 30" w file drawer Counterweight included	3024E-F-R2B	26 $\frac{7}{8}$ "	30"	117	\$1440	+\$145

9900 Series Laterals

No Match!
No Match!

How to order

1. Specify product number.
2. Specify finish color.
3. Specify options.

Product code key example 3018E-LHBKBFM

30 width
18 depth
E 9900 series front
LH left hand
BK bookcase
B 6" box drawer
F 12" file drawer
M mobile

Counterweights

Counterweight is included.

Castors

These cabinets will include two swivel casters with a brake and two swivel casters without brake.



Lock option

Locking is standard.

In the units with pedestals configurations, the lock is 2" off center towards the drawers. For the unit with the hinged door, the lock is in the door. Non-locking is not an available option for these units.

Finishes

Available in all standard paint colors. Refer to [Finishes section](#) for color options. Drawer bodies and accessories are finished in Eco Black.

Description	Part number	Height	Width	Case depth	Neutral paint/ base price	Accent paint
 <p>Fusion 9900 Series Mobile Storage & Bookcase Combo unit with 15" w open bookcase on one side and 15" w x 6" box over 12" file drawers on the other</p>	3018E-LHBKBFM left-hand bookcase (illustrated)	23 ¾"	30"	18"	\$1195	+\$123
	3018E-RHBKBFM right-hand bookcase	23 ¾"	30"	18"	\$1195	+\$123
<p>Fusion 9900 Series Mobile Storage & Bookcase Combo unit with 21" w open bookcase on one side and 15" w x 6" box over 12" file drawers on the other</p>	3618E-LHBKBFM left-hand bookcase	23 ¾"	36"	18"	\$1207	+\$124
	3618E-RHBKBFM right-hand bookcase	23 ¾"	36"	18"	\$1207	+\$124
 <p>Fusion 9900 Series Mobile Storage & Bookcase Combo unit with 15" w open bookcase on one side and 3 - 15" w x 6" box drawers on the other</p> <p>+\$124</p>	3018E-LHBK3BM left-hand bookcase (illustrated)	23 ¾"	30"	18"	\$1358	+\$138
	3018E-RHBK3BM right-hand bookcase	23 ¾"	30"	18"	\$1358	+\$138
	3618E-LHBK3BM left-hand bookcase	23 ¾"	36"	18"	\$1370	+\$139
	3618E-RHBK3BM right-hand bookcase	23 ¾"	36"	18"	\$1370	+\$139
 <p>Fusion 9900 Series Mobile Storage & Bookcase Combo unit with 15" w open bookcase on one side and 15" w hinged door on the other</p> <p>+\$124</p>	3018E-LHBKHDM left-hand bookcase (illustrated)	23 ¾"	30"	18"	\$1294	+\$131
	3018E-RHBKHDM right-hand bookcase	23 ¾"	30"	18"	\$1294	+\$131
	3618E-LHBKHDM left-hand bookcase	23 ¾"	36"	18"	\$1308	+\$132
	3618E-RHBKHDM right-hand bookcase	23 ¾"	36"	18"	\$1308	+\$132

9900 Series Laterals

Freestanding, Letter Width
Empty Field!

How to order

1. Specify product number.
2. Specify finish color.
3. Specify options.

Product code key example 36-48-HD2FE

- 36** cabinet width
48 interior height
HD hinged door
2 number of drawers
F 12" file drawer
E 9900 Series

Exterior cabinet heights are nominal. Actual heights (with glides fully recessed) are $\frac{1}{8}$ " less. Cabinets are priced inclusive 1 pair of hangfile bars in each pullout opening. Hinged doors are standard with self-closing European style hinges that open 110°. Shelves are slotted every 1 $\frac{1}{2}$ " and are height adjustable in 1 $\frac{1}{2}$ " increments. Shelf dividers are not included.

Cabinets are 18" in depth.

Counterweights

Counterweights are required for ALL freestanding units that are not anchored or ganged to other cabinets or bolted to walls/floor. See [Counterweight matrix](#).

Accessories

See [Lateral File Accessories](#) section for counterweights and accessories.

Lock option

Cabinets come standard with lock. If lock is not required add suffix '/NL' after product number. Deduct \$57 list.

Finishes

Refer to [Finishes section](#) for color options. Drawer bodies and accessories are finished in Eco Black.

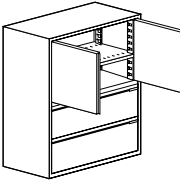
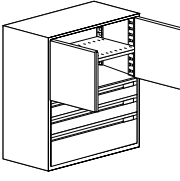
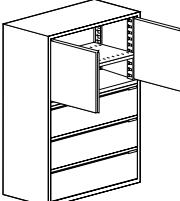
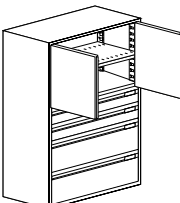
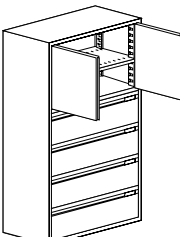
Description	Part number	Exterior Height	Width	Weight (lbs)	9900 series/ Neutral paint	Accent paint
 <p>4 high cabinet top opening 24" hinged door cupboard insert with 1 adjustable slotted shelf, other 2 openings 12" fixed front drawers</p>	30-48-HD2FE	50 $\frac{7}{8}$ "	30"	170	\$1787	+\$181
	36-48-HD2FE	50 $\frac{7}{8}$ "	36"	195	\$2051	+\$208
	42-48-HD2FE	50 $\frac{7}{8}$ "	42"	230	\$2310	+\$234
 <p>4 high cabinet Cabinet with top opening 24" hinged door cupboard insert with 1 adjustable slotted shelf, next 2 openings 6" fixed front drawers, bottom opening 12" fixed front drawer</p>	30-48-HD2BFE	50 $\frac{7}{8}$ "	30"	175	\$1942	+\$197
	36-48-HD2BFE	50 $\frac{7}{8}$ "	36"	200	\$2225	+\$225
	42-48-HD2BFE	50 $\frac{7}{8}$ "	42"	235	\$2505	+\$253
 <p>5 high cabinet top opening 24" hinged door cupboard insert with 1 adjustable slotted shelf, other 3 openings 12" fixed front drawers</p>	30-60-HD3FE	62 $\frac{7}{8}$ "	30"	195	\$2129	+\$214
	36-60-HD3FE	62 $\frac{7}{8}$ "	36"	230	\$2414	+\$245
	42-60-HD3FE	62 $\frac{7}{8}$ "	42"	260	\$2720	+\$275
 <p>5 high cabinet top opening 24" hinged door cupboard insert with 1 adjustable slotted shelf, next 2 openings 6" fixed front drawers, bottom 2 openings 12" fixed front drawers</p>	30-60-HD2B2FE	62 $\frac{7}{8}$ "	30"	195	\$2287	+\$231
	36-60-HD2B2FE	62 $\frac{7}{8}$ "	36"	230	\$2585	+\$262
	42-60-HD2B2FE	62 $\frac{7}{8}$ "	42"	260	\$2912	+\$293
 <p>6 high cabinet top opening 24" hinged door cupboard insert with 1 adjustable slotted shelf, other 4 openings 12" fixed front drawers</p>	30-72-HD4FE	74 $\frac{7}{8}$ "	30"	250	\$2591	+\$262
	36-72-HD4FE	74 $\frac{7}{8}$ "	36"	270	\$2937	+\$295
	42-72-HD4FE	74 $\frac{7}{8}$ "	42"	291	\$3279	+\$330

9900 Series Laterals

No Match!
No Match!

How to order

1. Specify product number.
2. Specify finish color.
3. Specify options.

Product code key example 36-49.5-HDF10FE

- 36** cabinet width
49.5 interior height
HD hinged door
F10 10½" file drawer
F 12" file drawer
E 9900 Series

Exterior cabinet heights are nominal. Actual heights (with glides fully recessed) are ¼" less. Cabinets are priced inclusive 1 pair of hangfile bars in each pullout opening. Hinged doors are standard with self-closing European style hinges that open 110°. Shelves are slotted every 1½" and are height adjustable in 1½" increments. Shelf dividers are not included.

Cabinets are 18" in depth.

Counterweights

Counterweights are required for ALL freestanding units that are not anchored or ganged to other cabinets or bolted to walls/floor. See [Counterweight matrix](#).

Accessories

See [Lateral File Accessories](#) section for counterweights and accessories.

Lock option

Cabinets come standard with lock. If lock is not required add suffix '/NL' after product number. Deduct \$57 list.

Finishes

Refer to [Finishes section](#) for color options. Drawer bodies and accessories are finished in Eco Black.

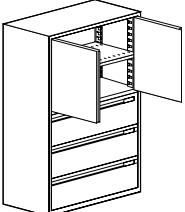
Description	Part number	Exterior Height	Width	Weight (lbs)	9900 series/ Neutral paint	Accent paint
 <p>4 high cabinet top opening 27" hinged door cupboard insert with 1 adjustable slotted shelf, next opening 10.5" fixed front drawer, other opening 12" fixed front drawer.</p>	3049.5-HDF10FE	52 ¾"	30"	170	\$1802	+\$182
	3649.5-HDF10FE	52 ¾"	36"	195	\$2052	+\$208
	4249.5-HDF10FE	52 ¾"	42"	230	\$2311	+\$234
 <p>4 high cabinet top opening 27" hinged door cupboard insert with 1 adjustable slotted shelf, other 2 openings 12" fixed front drawers, 1.5" tie bar</p>	30525HD2FE	55 ¾"	30"	170	\$1820	+\$184
	36525HD2FE	55 ¾"	36"	195	\$2061	+\$209
	42525HD2FE	55 ¾"	42"	230	\$2330	+\$237
 <p>5 high cabinet top opening 27" hinged door cupboard insert with 1 adjustable slotted shelf, other 3 openings 10.5" fixed front drawers</p>	3058.5-HD3F10E	61 ¾"	30"	195	\$2127	+\$214
	3658.5-HD3F10E	61 ¾"	36"	230	\$2412	+\$245
	4258.5-HD3F10E	61 ¾"	42"	260	\$2719	+\$275
 <p>5 high cabinet top opening 27" hinged door cupboard insert with 1 adjustable slotted shelf, 2-10.5" fixed front drawers and 1-12" fixed front drawer</p>	3060HD2F10FE	62 7/8"	30"	195	\$2129	+\$214
	3660HD2F10FE	62 7/8"	36"	230	\$2414	+\$245
	4260HD2F10FE	62 7/8"	42"	260	\$2720	+\$275
 <p>5 high cabinet top opening 27" hinged door cupboard insert with 1 adjustable slotted shelf, 1 opening 10.5" fixed front drawer and 2-12" fixed front drawers</p>	3061.5HDF102FE	64 ¾"	30"	200	\$2131	+\$215
	3661.5HDF102FE	64 ¾"	36"	235	\$2415	+\$245
	4261.5HDF102FE	64 ¾"	42"	265	\$2721	+\$275

9900 Series Laterals

No Match!
No Match!

How to order

1. Specify product number.
2. Specify finish color.
3. Specify options.

Product code key example 3669-HD4F10E

- 36** cabinet width
69 interior height
HD hinged door
4 number of drawers
F10 10 1/2" file drawer
E 9900 Series

Exterior cabinet heights are nominal. Actual heights (with glides fully recessed) are 1/8" less. Cabinets are priced inclusive 1 pair of hangfile bars in each pullout opening. Hinged doors are standard with self-closing European style hinges that open 110°. Shelves are slotted every 1 1/2" and are height adjustable in 1 1/2" increments. Shelf dividers are not included.

Cabinets are 18" in depth.

Counterweights

Counterweights are required for ALL freestanding units that are not anchored or ganged to other cabinets or bolted to walls/floor. See [Counterweight matrix](#).

Accessories

See [Lateral File Accessories](#) section for counterweights and accessories.

Lock option

Cabinets come standard with lock. If lock is not required add suffix '/NL' after product number. Deduct \$57 list.

Finishes

Refer to [Finishes section](#) for color options. Drawer bodies and accessories are finished in Eco Black.

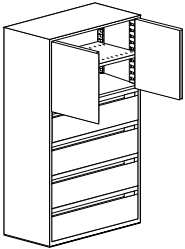
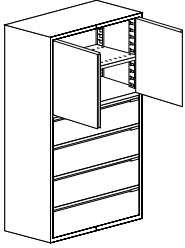
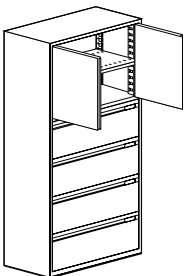
Description	Part number	Exterior Height	Width	Weight (lbs)	9900 series/ Neutral paint	Accent paint
 <p>5 high cabinet top opening 27" hinged door cupboard insert with 1 adjustable slotted shelf other 4 openings 10.5" fixed front drawers</p>	3069-HD4F10E	71 7/8"	30"	230	\$2534	+\$255
	3669-HD4F10E	71 7/8"	36"	266	\$2880	+\$290
	4269-HD4F10E	71 7/8"	42"	301	\$3220	+\$324
 <p>6 high cabinet top opening 27" hinged door cupboard insert with 1 adjustable slotted shelf, 1-10.5" fixed front drawers and 3" 12" fixed front drawers</p>	30735HDF103FE	76 3/8"	30"	250	\$2614	+\$264
	36735HDF103FE	76 3/8"	36"	270	\$2968	+\$299
	42735HDF103FE	76 3/8"	42"	291	\$3318	+\$334
 <p>6 high cabinet top opening 27" hinged door cupboard insert with 1 adjustable slotted shelf, other 4 openings 12" fixed front drawers</p>	30-75-HD4FE	77 7/8"	30"	250	\$2653	+\$267
	36-75-HD4FE	77 7/8"	36"	270	\$3001	+\$302
	42-75-HD4FE	77 7/8"	42"	291	\$3350	+\$337

9900 Series Laterals

Freestanding, Letter Width
Empty Field!

How to order

1. Specify product number.
2. Specify finish color.
3. Specify options.

Product code key example 36615-SS3FE

- 36** cabinet width
615 interior height
SS SuperStor™ insert
3 number of drawers
F 12" file drawer
E 9900 Series

Exterior cabinet heights are nominal. Actual heights (with glides fully recessed) are $\frac{1}{8}$ " less. 25 $\frac{1}{2}$ " and 51" SuperStor inserts have three vertical compartments with slots at 1" increments. Each compartment in the 25 $\frac{1}{2}$ " insert holds 22 trays. Each compartment in the 51" insert holds 48 trays. SuperStor trays, **which are sold separately** slide into the slots. Tray fronts angle downwards $\frac{1}{2}$ " to permit labeling. Cabinets are priced inclusive 1 pair of hangfile bars in each pullout opening.

Cabinets are 18" in depth.

Counterweights

Counterweights are required for ALL freestanding units that are not anchored or ganged to other cabinets or bolted to walls/floor. See [Counterweight matrix](#).

Accessories

See [Lateral File Accessories](#) section for counterweights and accessories.

Lock option

Cabinets come standard with lock. If lock is not required add suffix '/NL' after product number. Deduct \$57 list.

Finishes

Refer to [Finishes section](#) for color options. Drawer bodies and accessories are finished in Eco Black.

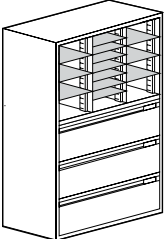
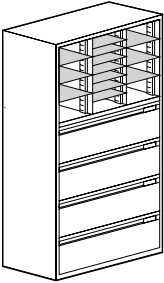
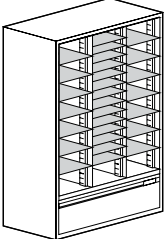
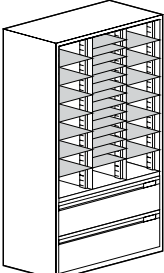
Description	Part number	Exterior Height	Width	Weight (lbs)	9900 series/ Neutral paint	Accent paint
 <p>Cabinet with 25.5" SuperStor™ insert and 3-12" fixed front drawers Order trays separately</p>	36615-SS3FE	64 $\frac{3}{8}$ "	36"	199	\$2326	+\$235
 <p>Cabinet with 25.5" SuperStor™ insert and 4-12" fixed front drawers Order trays separately.</p>	36735-SS4FE	76 $\frac{3}{8}$ "	36"	231	\$2884	+\$290
 <p>Cabinet with 51" SuperStor™ insert and 1-10.5" fixed front drawer Order trays separately</p>	36615-SSF10E	64 $\frac{3}{8}$ "	36"	211	\$2005	+\$204
 <p>Cabinet with 51" SuperStor™ insert and 1-10.5" fixed front drawer and 1-12" fixed front drawer Order trays separately</p>	36735-SSF10FE	76 $\frac{3}{8}$ "	36"	243	\$2557	+\$258

9900 Series Laterals

Freestanding, Letter Width Mailroom Units with SuperStor™ Insert

How to order

1. Specify product number.
2. Specify finish color.
3. Specify options.

Product code key example 36615-SSHD3FE

- 36** cabinet width
615 interior height
SS SuperStor™ insert
HD hinged doors
3 number of drawers
F 12" file drawer
E 9900 Series

Exterior cabinet heights are nominal. Actual heights (with glides fully recessed) are $\frac{1}{8}$ " less. 25 $\frac{1}{2}$ " and 51" SuperStor inserts have three vertical compartments with slots at 1" increments. Each compartment in the 25 $\frac{1}{2}$ " insert holds 22 trays. Each compartment in the 51" insert holds 48 trays. SuperStor trays, **which are sold separately** slide into the slots. Tray fronts angle downwards $\frac{1}{2}$ " to permit labeling. Cabinets are priced inclusive 1 pair of hangfile bars in each pullout opening

Cabinets are 18" in depth.

Counterweights

Counterweights are required for ALL freestanding units that are not anchored or ganged to other cabinets or bolted to walls/floor. See [Counterweight matrix](#).

Accessories

See [Lateral File Accessories](#) section for counterweights and accessories.

Lock option

Cabinets come standard with lock. If lock is not required add suffix '/NL' after product number. Deduct \$57 list.

Finishes

Refer to [Finishes section](#) for color options. Drawer bodies and accessories are finished in Eco Black.

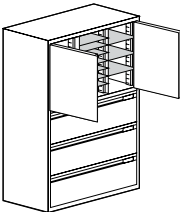
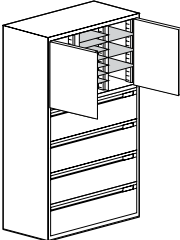
Description	Part number	Exterior Height	Width	Weight (lbs)	9900 series/ Neutral paint	Accent paint
 <p>Cabinet with 25.5" SuperStor™ insert with hinged doors and 3-12" fixed front drawers Order trays separately</p>	36615-SSHD3FE	64 $\frac{3}{8}$ "	36"	224	\$2689	+\$272
 <p>Cabinet with 25.5" SuperStor™ insert with hinged doors and 4-12" fixed front drawers Order trays separately</p>	36735-SSHD4FE	76 $\frac{3}{8}$ "	36"	256	\$3243	+\$327
 <p>Cabinet with 51" SuperStor™ insert with hinged doors and 1-10.5" fixed front drawer Order trays separately</p>	36615-SSHDF10E	64 $\frac{3}{8}$ "	36"	296	\$2591	+\$262
 <p>Cabinet with 51" SuperStor™ insert with hinged doors and 1-10.5" fixed front drawer and 1-12" fixed front drawer Order trays separately</p>	36735-SSHDF10FE	76 $\frac{3}{8}$ "	36"	328	\$3148	+\$318
 <p>SuperStor™ trays Pack of 12 trays, black only</p>	T12SS-BL	—	10"	25	\$268	—

9900 Series Laterals

Freestanding, Letter Width Storage and Wardrobe Cabinets

How to order

1. Specify product number.
2. Specify finish color.
3. Specify options.

Product code key example 3615SDO-SH

36 cabinet width
15 interior height
SDO sliding doors
SH shelves

Shelves are slotted every 1 1/2" and are height adjustable in 1 1/2" increments. Shelf dividers are not included.

Cabinets are 18" in depth.

Note: Lock is located center bottom of the case

Counterweights

Counterweights are required for ALL freestanding units that are not anchored or ganged to other cabinets or bolted to walls/floor. See [Counterweight matrix](#).

Accessories

See [Lateral File Accessories](#) section for counterweights and accessories.

Lock option

Cabinets come standard with lock. If lock is not required add suffix '/NL' after product number. Deduct \$57 list.

Finishes

Refer to [Finishes section](#) for color options. Drawer bodies and accessories are finished in Eco Black.

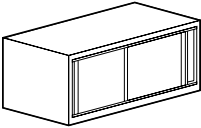
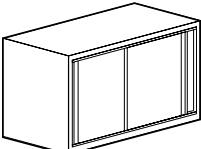
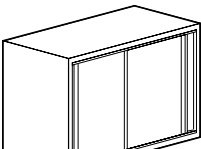
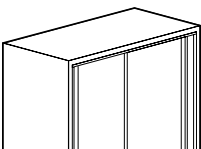
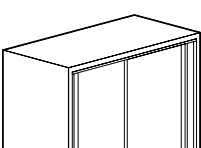
Description	Part number	Exterior Height	Width	Weight (lbs)	Storage centers/ 9900 Series/ Neutral paint	Accent paint
	3015SDO	17 7/8"	30"	39	\$735	+\$74
	3615SDO	17 7/8"	36"	48	\$799	+\$84
	4215SDO	17 7/8"	42"	57	\$843	+\$88
Cabinet with sliding doors with 1 slotted shelf	3015SDO-SH	17 7/8"	30"	49	\$839	+\$87
	3615SDO-SH	17 7/8"	36"	59	\$904	+\$93
	4215SDO-SH	17 7/8"	42"	69	\$947	+\$98
	3021SDO	23 7/8"	30"	47	\$812	+\$85
	3621SDO	23 7/8"	36"	65	\$867	+\$90
	4221SDO	23 7/8"	42"	83	\$923	+\$96
Cabinet with sliding doors with 1 slotted shelf	3021SDO-SH	23 7/8"	30"	57	\$914	+\$94
	3621SDO-SH	23 7/8"	36"	76	\$971	+\$100
	4221SDO-SH	23 7/8"	42"	95	\$1029	+\$105
	3024SDO	26 7/8"	30"	75	\$812	+\$85
	3624SDO	26 7/8"	36"	95	\$867	+\$90
	4224SDO	26 7/8"	42"	110	\$923	+\$96
Cabinet with sliding doors with 1 slotted shelf	3024SDO-SH	26 7/8"	30"	85	\$914	+\$94
	3624SDO-SH	26 7/8"	36"	105	\$971	+\$100
	4224SDO-SH	26 7/8"	42"	115	\$1029	+\$105
	3027SDO	29 7/8"	30"	83	\$885	+\$91
	3627SDO	29 7/8"	36"	104	\$921	+\$94
	4227SDO	29 7/8"	42"	120	\$1001	+\$102
Cabinet with sliding doors with 1 slotted shelf	3027SDO-SH	29 7/8"	30"	94	\$989	+\$101
	3627SDO-SH	29 7/8"	42"	117	\$1026	+\$105
	4227SDO-SH	29 7/8"	42"	135	\$1105	+\$112
	3030SDO	32 7/8"	30"	115	\$936	+\$97
	3630SDO	32 7/8"	36"	120	\$970	+\$100
	4230SDO	32 7/8"	42"	130	\$1072	+\$108
Cabinet with sliding doors with 1 slotted shelf	3030SDO-SH	32 7/8"	30"	120	\$1038	+\$106
	3630SDO-SH	32 7/8"	36"	135	\$1073	+\$110
	4230SDO-SH	32 7/8"	42"	140	\$1173	+\$120

9900 Series Laterals

Freestanding, Letter Width Overfile and Storage Cabinets

How to order

1. Specify product number.
2. Specify finish color.
3. Specify options.

Product code key example 3621HDE-SH

36 cabinet width
21 interior height
HD hinged doors
E 9900 Series
SH shelves

Exterior cabinet heights are nominal. Actual heights (with glides fully recessed) are $\frac{1}{8}$ " less. Hinged doors are standard with self-closing European style hinges that open 110°. Shelves are slotted every 1 $\frac{1}{2}$ " and are height adjustable in 1 $\frac{1}{2}$ " increments. Shelf dividers are not included.

Cabinets are 18" in depth.

Accessories

See [Lateral File Accessories](#) section for counterweights and accessories.

Lock option

Cabinets come standard with lock. If lock is not required add suffix '**NL**' after product number. Deduct \$57 list.

Finishes

Refer to [Finishes section](#) for color options. Drawer bodies and accessories are finished in Eco Black.

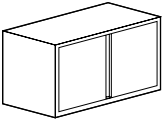
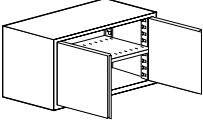
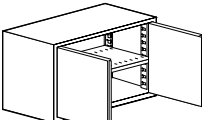
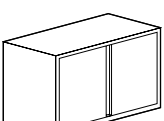
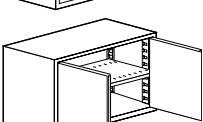
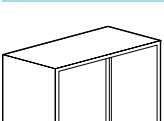
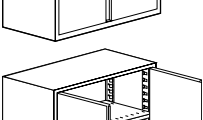
Description	Part number	Exterior Height	Width	Weight (lbs)	9900 series/ Neutral point	Accent point
 Cabinet with hinged doors, no interior accessories	3021HDE	23 $\frac{7}{8}$ "	30"	47	\$799	+\$84
	3621HDE	23 $\frac{7}{8}$ "	36"	65	\$853	+\$89
	4221HDE	23 $\frac{7}{8}$ "	42"	83	\$910	+\$94
 Cabinet with hinged doors with 1 slotted shelf	3021HDE-SH	23 $\frac{7}{8}$ "	30"	57	\$901	+\$93
	3621HDE-SH	23 $\frac{7}{8}$ "	36"	76	\$955	+\$98
	4221HDE-SH	23 $\frac{7}{8}$ "	42"	95	\$1014	+\$103
 Cabinet with hinged doors, no interior accessories	3024HDE	26 $\frac{7}{8}$ "	30"	75	\$799	+\$84
	3624HDE	26 $\frac{7}{8}$ "	36"	95	\$853	+\$89
	4224HDE	26 $\frac{7}{8}$ "	42"	110	\$910	+\$94
 Cabinet with hinged doors with 1 slotted shelf	3024HDE-SH	26 $\frac{7}{8}$ "	30"	85	\$901	+\$93
	3624HDE-SH	26 $\frac{7}{8}$ "	36"	105	\$955	+\$98
	4224HDE-SH	26 $\frac{7}{8}$ "	42"	115	\$1014	+\$103
 Cabinet with hinged doors, no interior accessories	3027HDE	29 $\frac{7}{8}$ "	30"	83	\$872	+\$90
	3627HDE	29 $\frac{7}{8}$ "	36"	104	\$907	+\$93
	4227HDE	29 $\frac{7}{8}$ "	42"	120	\$984	+\$101
 Cabinet with hinged doors with 1 slotted shelf	3027HDE-SH	29 $\frac{7}{8}$ "	30"	94	\$976	+\$100
	3627HDE-SH	29 $\frac{7}{8}$ "	36"	117	\$1009	+\$103
	4227HDE-SH	29 $\frac{7}{8}$ "	42"	135	\$1089	+\$111
 Cabinet with hinged doors, no interior accessories	3030HDE	32 $\frac{7}{8}$ "	30"	115	\$920	+\$94
	3630HDE	32 $\frac{7}{8}$ "	36"	120	\$954	+\$98
	4230HDE	32 $\frac{7}{8}$ "	42"	130	\$1053	+\$107
 Cabinet with hinged doors with 1 slotted shelf	3030HDE-SH	32 $\frac{7}{8}$ "	30"	120	\$1023	+\$104
	3630HDE-SH	32 $\frac{7}{8}$ "	36"	135	\$1055	+\$107
	4230HDE-SH	32 $\frac{7}{8}$ "	42"	140	\$1156	+\$119

9900 Series Laterals

Freestanding, Letter Width Storage and Wardrobe Cabinets

How to order

1. Specify product number.
2. Specify finish color.
3. Specify options.

Product code key example 3636HDE-SH

36 cabinet width
36 interior height
HD hinged doors
E 9900 Series
SH shelves

Exterior cabinet heights are nominal. Actual heights (with glides fully recessed) are $\frac{1}{8}$ " less. Hinged doors are standard with self-closing European style hinges that open 110°. Shelves are slotted every 1 $\frac{1}{2}$ " and are height adjustable in 1 $\frac{1}{2}$ " increments. Shelf dividers are not included.

Cabinets are 18" in depth.

Accessories

See [Lateral File Accessories](#) section for counterweights and accessories.

Lock option

Cabinets come standard with lock. If lock is not required add suffix '**NL**' after product number. Deduct \$57 list.

Finishes

Refer to [Finishes section](#) for color options. Drawer bodies and accessories are finished in Eco Black.

Description	Part number	Exterior Height	Width	Weight (lbs)	9900 series/ Neutral paint	Accent paint
	3036HDE	38 $\frac{7}{8}$ "	30"	130	\$937	+\$97
	3636HDE	38 $\frac{7}{8}$ "	36"	140	\$1026	+\$105
	4236HDE	38 $\frac{7}{8}$ "	42"	150	\$1129	+\$115
	3036HDE-SH	38 $\frac{7}{8}$ "	30"	145	\$1140	+\$116
	3636HDE-SH	38 $\frac{7}{8}$ "	36"	155	\$1231	+\$126
	4236HDE-SH	38 $\frac{7}{8}$ "	42"	165	\$1332	+\$135
	3040.5HDE	43 $\frac{3}{8}$ "	30"	135	\$969	+\$100
	3640.5HDE	43 $\frac{3}{8}$ "	36"	145	\$1085	+\$111
	4240.5HDE	43 $\frac{3}{8}$ "	42"	160	\$1230	+\$126
	3040.5HDE-SH	43 $\frac{3}{8}$ "	30"	145	\$1173	+\$120
	3640.5HDE-SH	43 $\frac{3}{8}$ "	36"	155	\$1288	+\$131
	4240.5HDE-SH	43 $\frac{3}{8}$ "	42"	165	\$1433	+\$144
	3045HDE	47 $\frac{7}{8}$ "	30"	135	\$996	+\$102
	3645HDE	47 $\frac{7}{8}$ "	36"	145	\$1157	+\$119
	4245HDE	47 $\frac{7}{8}$ "	42"	155	\$1325	+\$134
	3045HDE-SH	47 $\frac{7}{8}$ "	30"	145	\$1203	+\$124
	3645HDE-SH	47 $\frac{7}{8}$ "	36"	155	\$1360	+\$138
	4245HDE-SH	47 $\frac{7}{8}$ "	42"	165	\$1527	+\$156

9900 Series Laterals

Freestanding, Letter Width Storage and Wardrobe Cabinets

How to order

1. Specify product number.
2. Specify finish color.
3. Specify options.

Product code key example 3648HDE-SH

36 cabinet width
48 interior height
HD hinged doors
E 9900 Series
SH shelves

Exterior cabinet heights are nominal. Actual heights (with glides fully recessed) are $\frac{1}{8}$ " less. Hinged doors are standard with self-closing European style hinges that open 110°. Shelves are slotted every 1 $\frac{1}{2}$ " and are height adjustable in 1 $\frac{1}{2}$ " increments. Shelf dividers are not included.

Cabinets are 18" in depth.

Accessories

See [Lateral File Accessories](#) section for counterweights and accessories.

Lock option

Cabinets come standard with lock. If lock is not required add suffix '**NL**' after product number. Deduct \$57 list.

Finishes

Refer to [Finishes section](#) for color options. Drawer bodies and accessories are finished in Eco Black.

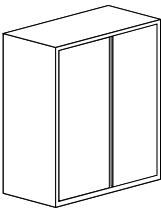
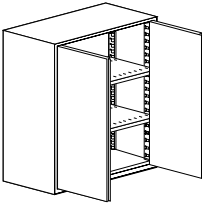
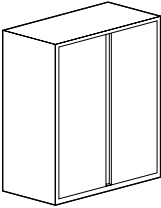
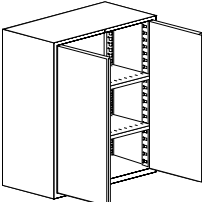
Description	Part number	Exterior Height	Width	Weight (lbs)	9900 series/ Neutral paint	Accent paint
 Cabinet with hinged doors no interior accessories	3048HDE	50 $\frac{7}{8}$ "	30"	160	\$1059	+\$107
	3648HDE	50 $\frac{7}{8}$ "	36"	170	\$1205	+\$124
	4248HDE	50 $\frac{7}{8}$ "	42"	190	\$1369	+\$139
 Cabinet with hinged doors with 2 slotted shelves	3048HDE-SH	50 $\frac{7}{8}$ "	30"	165	\$1265	+\$129
	3648HDE-SH	50 $\frac{7}{8}$ "	36"	175	\$1408	+\$142
	4248HDE-SH	50 $\frac{7}{8}$ "	42"	195	\$1574	+\$161
 Cabinet with hinged doors no interior accessories	3049.5HDE	52 $\frac{3}{8}$ "	30"	160	\$1059	+\$107
	3649.5HDE	52 $\frac{3}{8}$ "	36"	170	\$1205	+\$124
	4249.5HDE	52 $\frac{3}{8}$ "	42"	190	\$1369	+\$139
 Cabinet with hinged doors with 2 slotted shelves	3049.5HDE-SH	52 $\frac{3}{8}$ "	30"	170	\$1265	+\$129
	3649.5HDE-SH	52 $\frac{3}{8}$ "	36"	180	\$1408	+\$142
	4249.5HDE-SH	52 $\frac{3}{8}$ "	42"	200	\$1574	+\$161

9900 Series Laterals

Freestanding, Letter Width Storage and Wardrobe Cabinets

How to order

1. Specify product number.
2. Specify finish color.
3. Specify options.

Product code key example 3654HDE-SH

36 cabinet width
54 interior height
HD hinged doors
E 9900 Series
SH shelves

Exterior cabinet heights are nominal. Actual heights (with glides fully recessed) are $\frac{1}{8}$ " less. Hinged doors are standard with self-closing European style hinges that open 110°. Shelves are slotted every 1 $\frac{1}{2}$ " and are height adjustable in 1 $\frac{1}{2}$ " increments. Shelf dividers are not included.

Cabinets are 18" in depth.

Accessories

See [Lateral File Accessories](#) section for counterweights and accessories.

Lock option

Cabinets come standard with lock. If lock is not required add suffix '**/NL**' after product number. Deduct \$57 list.

Finishes

Refer to [Finishes section](#) for color options. Drawer bodies and accessories are finished in Eco Black.

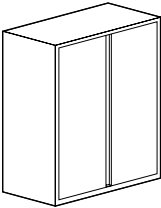
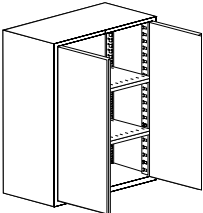
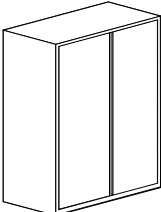
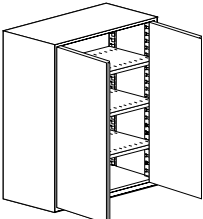
Description	Part number	Exterior Height	Width	Weight (lbs)	9900 series/ Neutral paint	Accent paint
 Cabinet with hinged doors, no interior accessories	3052.5HDE	55 $\frac{3}{8}$ "	30"	160	\$1077	+\$110
	3652.5HDE	55 $\frac{3}{8}$ "	36"	170	\$1232	+\$126
	4252.5HDE	55 $\frac{3}{8}$ "	42"	190	\$1419	+\$143
 Cabinet with hinged doors with 2 slotted shelves	3052.5HDE-SH	55 $\frac{3}{8}$ "	30"	170	\$1279	+\$130
	3652.5HDE-SH	55 $\frac{3}{8}$ "	36"	180	\$1437	+\$145
	4252.5HDE-SH	55 $\frac{3}{8}$ "	42"	200	\$1624	+\$166
 Cabinet with hinged doors no interior accessories	3054HDE	56 $\frac{7}{8}$ "	30"	165	\$1085	+\$111
	3654HDE	56 $\frac{7}{8}$ "	36"	175	\$1236	+\$127
	4254HDE	56 $\frac{7}{8}$ "	42"	195	\$1281	+\$130
 Cabinet with hinged doors with 3 slotted shelves	3054HDE-SH	56 $\frac{7}{8}$ "	30"	180	\$1389	+\$141
	3654HDE-SH	56 $\frac{7}{8}$ "	36"	190	\$1541	+\$157
	4254HDE-SH	56 $\frac{7}{8}$ "	42"	210	\$1728	+\$175

9900 Series Laterals

Freestanding, Letter Width Storage and Wardrobe Cabinets

How to order

1. Specify product number.
2. Specify finish color.
3. Specify options.

Product code key example 3660HDE-SH

36 cabinet width
60 interior height
HD hinged doors
E 9900 Series
SH shelves

Exterior cabinet heights are nominal. Actual heights (with glides fully recessed) are $\frac{1}{8}$ " less. Hinged doors are standard with self-closing European style hinges that open 110°. Shelves are slotted every 1 $\frac{1}{2}$ " and are height adjustable in 1 $\frac{1}{2}$ " increments. Shelf dividers are not included.

Cabinets are 18" in depth.

Accessories

See [Lateral File Accessories](#) section for counterweights and accessories.

Lock option

Cabinets come standard with lock. If lock is not required add suffix '**/NL**' after product number. Deduct \$57 list.

Finishes

Refer to [Finishes section](#) for color options. Drawer bodies and accessories are finished in Eco Black.

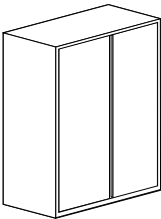
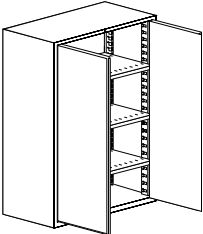
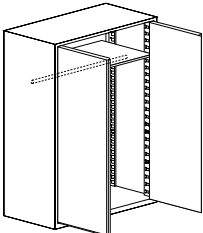
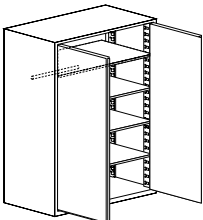
Description	Part number	Exterior Height	Width	Weight (lbs)	9900 series/ Neutral paint	Accent paint
 Cabinet with hinged doors no interior accessories	3060HDE	62 $\frac{7}{8}$ "	30"	170	\$1091	+\$111
	3660HDE	62 $\frac{7}{8}$ "	36"	185	\$1239	+\$127
	4260HDE	62 $\frac{7}{8}$ "	42"	210	\$1426	+\$144
 Cabinet with hinged doors with 3 slotted shelves	3060HDE-SH	62 $\frac{7}{8}$ "	30"	185	\$1396	+\$141
	3660HDE-SH	62 $\frac{7}{8}$ "	36"	200	\$1547	+\$157
	4260HDE-SH	62 $\frac{7}{8}$ "	42"	220	\$1732	+\$175
 Cabinet with 1 blank shelf and side-to-side coat rod	3060HDE-W	62 $\frac{7}{8}$ "	30"	175	\$1230	+\$126
	3660HDE-W	62 $\frac{7}{8}$ "	36"	185	\$1381	+\$140
	4260HDE-W	62 $\frac{7}{8}$ "	42"	215	\$1565	+\$160
 Cabinet with hinged doors, 1 full width blank shelf, 3 half width shelves and 1 half width coat rod	3060HDE-WS	62 $\frac{7}{8}$ "	30"	175	\$1465	+\$147
	3660HDE-WS	62 $\frac{7}{8}$ "	36"	185	\$1616	+\$165
	4260HDE-WS	62 $\frac{7}{8}$ "	42"	215	\$1802	+\$182

9900 Series Laterals

Freestanding, Letter Width
Storage and Wardrobe Cabinets

How to order

1. Specify product number.
2. Specify finish color.
3. Specify options.

Product code key example 3661.5HDE-SH

36 cabinet width
61.5 interior height
HD hinged doors
E 9900 Series
SH shelves

Exterior cabinet heights are nominal. Actual heights (with glides fully recessed) are $\frac{1}{8}$ " less. Hinged doors are standard with self-closing European style hinges that open 110°. Shelves are slotted every 1 $\frac{1}{2}$ " and are height adjustable in 1 $\frac{1}{2}$ " increments. Shelf dividers are not included.

Cabinets are 18" in depth.

Accessories

See [Lateral File Accessories](#) section for counterweights and accessories.

Lock option

Cabinets come standard with lock. If lock is not required add suffix '**NL**' after product number. Deduct \$57 list.

Finishes

Refer to [Finishes section](#) for color options. Drawer bodies and accessories are finished in Eco Black.

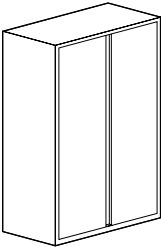
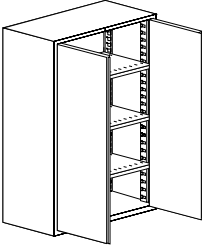
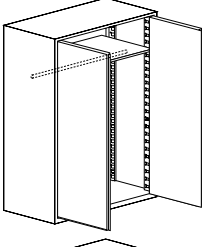
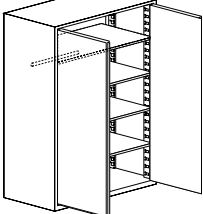
Description	Part number	Exterior Height	Width	Weight (lbs)	9900 series/ Neutral paint	Accent paint
 Cabinet with hinged doors no interior accessories	3061.5HDE	64 $\frac{3}{8}$ "	30"	175	\$1091	+\$111
	3661.5HDE	64 $\frac{3}{8}$ "	36"	185	\$1239	+\$127
	4261.5HDE	64 $\frac{3}{8}$ "	42"	215	\$1426	+\$144
 Cabinet with hinged doors with 3 slotted shelves	3061.5HDE-SH	64 $\frac{3}{8}$ "	30"	185	\$1396	+\$141
	3661.5HDE-SH	64 $\frac{3}{8}$ "	36"	200	\$1547	+\$157
	4261.5HDE-SH	64 $\frac{3}{8}$ "	42"	220	\$1732	+\$175
 Cabinet with hinged doors, 1 blank shelf and side-to-side coat rod	3061.5HDE-W	64 $\frac{3}{8}$ "	30"	175	\$1230	+\$126
	3661.5HDE-W	64 $\frac{3}{8}$ "	36"	185	\$1381	+\$140
	4261.5HDE-W	64 $\frac{3}{8}$ "	42"	215	\$1565	+\$160
 Cabinet with hinged doors, 1 full width blank shelf, 3 half width shelves and 1 half width coat rod	3061.5HDE-WS	64 $\frac{3}{8}$ "	30"	180	\$1465	+\$147
	3661.5HDE-WS	64 $\frac{3}{8}$ "	36"	190	\$1614	+\$165
	4261.5HDE-WS	64 $\frac{3}{8}$ "	42"	220	\$1802	+\$182

9900 Series Laterals

Freestanding, Letter Width Storage and Wardrobe Cabinets

How to order

1. Specify product number.
2. Specify finish color.
3. Specify options.

Product code key example 3667.5HDE-SH

36 cabinet width
67.5 interior height
HD hinged doors
E 9900 Series
SH shelves

Exterior cabinet heights are nominal. Actual heights (with glides fully recessed) are $\frac{1}{8}$ " less. Hinged doors are standard with self-closing European style hinges that open 110°. Shelves are slotted every 1 $\frac{1}{2}$ " and are height adjustable in 1 $\frac{1}{2}$ " increments. Shelf dividers are not included.

Cabinets are 18" in depth.

Accessories

See [Lateral File Accessories](#) section for counterweights and accessories.

Lock option

Cabinets come standard with lock. If lock is not required add suffix '**NL**' after product number. Deduct \$57 list.

Finishes

Refer to [Finishes section](#) for color options. Drawer bodies and accessories are finished in Eco Black.

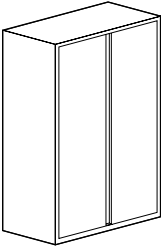
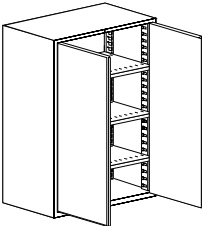
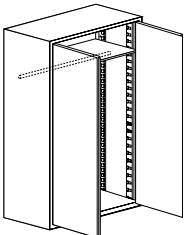
Description	Part number	Exterior Height	Width	Weight (lbs)	9900 series/ Neutral paint	Accent paint
 <p>Cabinet with hinged doors, no interior accessories</p>	3067.5HDE	70 $\frac{3}{8}$ "	30"	185	\$1206	+\$124
	3667.5HDE	70 $\frac{3}{8}$ "	36"	210	\$1372	+\$139
	4267.5HDE	70 $\frac{3}{8}$ "	42"	225	\$1555	+\$159
 <p>Cabinet with hinged doors with 3 slotted shelves</p>	3067.5HDE-SH	70 $\frac{3}{8}$ "	30"	205	\$1614	+\$165
	3667.5HDE-SH	70 $\frac{3}{8}$ "	36"	230	\$1777	+\$180
	4267.5HDE-SH	70 $\frac{3}{8}$ "	42"	245	\$1962	+\$199
 <p>Cabinet with hinged doors, 1 blank shelf and side-to-side coat rod</p>	3067.5HDE-W	70 $\frac{3}{8}$ "	30"	190	\$1344	+\$137
	3667.5HDE-W	70 $\frac{3}{8}$ "	36"	215	\$1511	+\$153
	4267.5HDE-W	70 $\frac{3}{8}$ "	42"	230	\$1692	+\$172

9900 Series Laterals

Freestanding, Letter Width
Storage and Wardrobe Cabinets

How to order

1. Specify product number.
2. Specify finish color.
3. Specify options.

Product code key example
3673.5HDE-SH

36 cabinet width
73.5 interior height
HD hinged doors
E 9900 Series
SH shelves

Exterior cabinet heights are nominal. Actual heights (with glides fully recessed) are $\frac{1}{8}$ " less. Hinged doors are standard with self-closing European style hinges that open 110°. Shelves are slotted every 1 $\frac{1}{2}$ " and are height adjustable in 1 $\frac{1}{2}$ " increments. Shelf dividers are not included.

Cabinets are 18" in depth.

Accessories

See [Lateral File Accessories](#) section for counterweights and accessories.

Lock option

Cabinets come standard with lock. If lock is not required add suffix '**NL**' after product number. Deduct \$57 list.

Finishes

Refer to [Finishes section](#) for color options. Drawer bodies and accessories are finished in Eco Black.

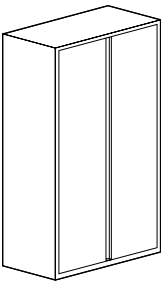
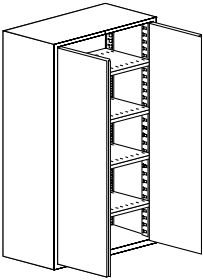
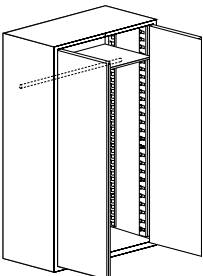
Description	Part number	Exterior Height	Width	Weight (lbs)	9900 series/ Neutral paint	Accent paint
 <p>Cabinet with hinged doors, no interior accessories</p>	3073.5HDE	76 $\frac{3}{8}$ "	30"	190	\$1322	+\$134
	3673.5HDE	76 $\frac{3}{8}$ "	36"	220	\$1502	+\$152
	4273.5HDE	76 $\frac{3}{8}$ "	42"	240	\$1687	+\$171
 <p>Cabinet with hinged doors with 4 slotted shelves</p>	3073.5HDE-SH	76 $\frac{3}{8}$ "	30"	210	\$1728	+\$175
	3673.5HDE-SH	76 $\frac{3}{8}$ "	36"	240	\$1910	+\$195
	4273.5HDE-SH	76 $\frac{3}{8}$ "	42"	260	\$2094	+\$211
 <p>Cabinet with hinged doors 1 blank shelf and side-to-side coat rod</p>	3073.5HDE-W	76 $\frac{3}{8}$ "	30"	195	\$1460	+\$147
	3673.5HDE-W	76 $\frac{3}{8}$ "	36"	225	\$1639	+\$167
	4273.5HDE-W	76 $\frac{3}{8}$ "	42"	245	\$1826	+\$184

9900 Series Laterals

Freestanding, Letter Width Storage Cabinet with SuperStor™ Insert

How to order

1. Specify product number.
2. Specify finish color.
3. Specify options.

Product code key example 3624DHE-SS

36 cabinet width
24 interior height
HD hinged doors
E 9900 Series
SS SuperStor™

Exterior cabinet heights are nominal. Actual heights (with glides fully recessed) are $\frac{1}{8}$ " less. SuperStor™ cabinets are equipped with an internal storage organizer that consists of three vertical compartments with slots at 1" increments. SuperStor™ trays, **which are sold separately**, slide into the slots. Tray fronts angle downwards $\frac{1}{2}$ " to permit labeling. Hinged doors are standard with self-closing European style hinges that open 110°.

Cabinets are 18" in depth.

Accessories

See [Lateral File Accessories](#) section for counterweights and accessories.

Lock option

Cabinets come standard with lock. If lock is not required add suffix '/NL' after product number. Deduct \$57 list.

Finishes

Refer to [Finishes section](#) for color options. Drawer bodies and accessories are finished in Eco Black.

Description	Part number	Exterior Height	Width	Weight (lbs)	9900 series/ Neutral paint	Accent paint
 <p>Cabinet with 24" high SuperStor™ insert. Three vertical compartments with slots at 1" increments hold 22 sliding trays per compartment.</p> <p>Order trays separately</p>	3624HDE-SS	26 $\frac{7}{8}$ "	36"	120	\$1347	+\$137
 <p>Cabinet with 49.5" high SuperStor™ insert. Three vertical compartments with slots at 1" increments hold 48" sliding trays per compartment.</p> <p>Order trays separately</p>	3649.5HDE-SS	53 $\frac{3}{8}$ "	36"	190	\$1975	+\$200
 <p>Cabinet with 49.5" high SuperStor™ insert. Three vertical compartments with slots at 1" increments hold 48" sliding trays per compartment. 10.5" clearance from bottom of cabinet to bottom of insert.</p> <p>Order trays separately.</p>	3661.5HDE-SS	64 $\frac{3}{8}$ "	36"	235	\$2048	+\$207
 <p>Cabinet with 49.5" high SuperStor™ insert. Three vertical compartments with slots at 1" increments hold 48" sliding trays per compartment. 22.5" clearance from bottom of cabinet to bottom of insert</p> <p>Order trays separately.</p>	3673.5HDE-SS	76 $\frac{3}{8}$ "	36"	270	\$2307	+\$234
 <p>SuperStor™ trays Pack of 12 trays, black only</p>	T12SS-BL	—	10"	25	\$268	—

9900 Series Laterals

Freestanding, Letter Width Bookcase/File Combination Cabinets

How to order

1. Specify product number.
2. Specify finish color.
3. Specify options.

Product code key example 36495E-2F10ISH

36	cabinet width
495	interior height
E	9900 Series
2	number of drawers
F10	10 1/2" fixed front drawers
ISH	number of adjustable shelves

Exterior cabinet heights are nominal. Actual heights (with glides fully recessed) are 1/8" less. Cabinets are priced inclusive of 1 pair of hangfile bars in each shelf above the file drawers. All shelves are slotted to accept dividers. Shelf dividers are not included. See Accessories section.

Cabinets are 18" in depth.

Counterweights

Counterweights are required for ALL freestanding units that are not anchored or ganged to other cabinets or bolted to walls/floor. See [Counterweight matrix](#).

Accessories

See [Lateral File Accessories](#) section for counterweights and accessories.

Lock option

Cabinets come standard with lock. If lock is not required add suffix '/NL' after product number. Deduct \$57 list.

Finishes

Refer to [Finishes section](#) for color options. Drawer bodies and accessories are finished in Eco Black.

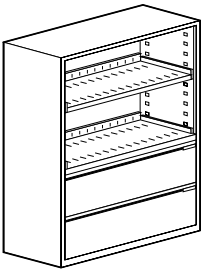
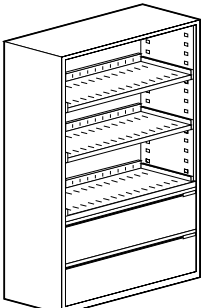
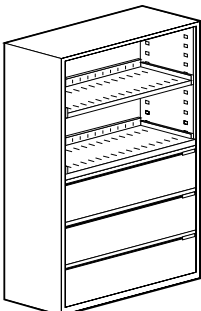
Description	Part number	Exterior Height	Width	Weight (lbs)	9900 series/ Neutral paint	Accent paint
 <p>4 high cabinet with 2 bookcase openings and 2-10.5" drawers</p> <p>Bookcase Opening Clearances Top 12.5" Bottom 14"</p>	30495E-2F10ISH	52 3/8"	30"	165	\$1457	+\$147
	36495E-2F10ISH	52 3/8"	36"	183	\$1694	+\$172
	42495E-2F10ISH	52 3/8"	42"	210	\$1907	+\$194
 <p>5 high cabinet with 3 bookcase openings and 2-10.5" drawers</p> <p>Bookcase Opening Clearances Top 12.5" Middle 12.5" Bottom 13"</p>	30615E-2F102SH	64 3/8"	30"	187	\$1613	+\$165
	36615E-2F102SH	64 3/8"	36"	210	\$1824	+\$184
	42615E-2F102SH	64 3/8"	42"	240	\$2048	+\$207
 <p>5 high cabinet with 2 bookcase openings and 3-10.5" drawers</p> <p>Bookcase Opening Clearances Top 14" Bottom 14"</p>	30615E-3F101SH	64 3/8"	30"	190	\$1615	+\$165
	36615E-3F101SH	64 3/8"	36"	212	\$2060	+\$208
	42615E-3F101SH	64 3/8"	42"	243	\$2320	+\$235



Verticals

US Price List • June 2021

No Match!

ANSI/BIFMA

With the addition of counterweights where appropriate, verticals meet all ANSI/BIFMA specifications.

Construction

Vertical files are of all-welded construction using high quality, tension leveled, cold rolled steel. The steel gauges selected for drawer fronts, bodies and accessories ensure the highest quality durability and performance for all components.

Construction features & benefits

1. "Wrap-around" construction with no visible vertical seams gives a clean appearance, providing rigid construction and dust-free interiors.
2. Verticals have sound-absorbing materials for quieter operation – a particular asset in open plan environments.
3. Drawer bodies have full-height sides to accommodate hanging file folders, eliminating the need for optional file frames.
4. Drawer sides are slotted on $\frac{3}{4}$ " centers to allow for maximum flexibility for drawer division. Compressors are optional. Verticals may be ordered with or without compressors in each drawer.
5. Fully-progressive ball bearing suspensions, are staged so that left and right sides work in unison. This provides smooth drawer operation with minimum force.
6. Staged suspensions allow the drawer to be completely pulled out, providing access to the entire drawer depth.
7. Special "claw-like" device incorporated in the suspension "grips" the fixed section of the suspension arm preventing drawer bounce-back or creep when drawer is closed.

Safelock™

The patented Safelock mechanism provides complete security against accidental opening of two or more drawers simultaneously. When any drawer is extended, even fractionally, Safelock ensures that all other drawers immediately become inoperable. Safelock is standard on all vertical files.

Counterweights

Counterweights are required for ALL freestanding units that are not anchored or ganged to other cabinets or bolted to walls/floor.

Bases

Optional base aprons are available in 2 heights and are screwed to the underside of the file case. Bases may be easily added or changed on site. Vertical files are shipped with bases installed when ordered.

Glides

Overall heights are inclusive of metal glides. Heights may be increased up to $\frac{5}{8}$ " by extending standard glide. Glides are accessible from inside the vertical file when the bottom drawer is removed and may be adjusted with a $\frac{1}{4}$ " socket driver.

Locks

Vertical files come standard with lock. If lock is not required add suffix '**NL**' after product number. Deduct \$57 list per lock. For lock location, see the guide at the beginning of this price list.

Random keying is standard. Verticals may be ordered keyed alike. Specify. Locks feature removable core and are standard with two keys.

Cabinets originally ordered as non-locking may be field installed with the addition of locking bars and a lock core. Please contact Office Specialty Client Services for required parts.

Master keys are available at \$51 list. For lock finish options, refer to the front of this price list.

Finishes

Refer to [Finishes section](#) for color options. Drawer bodies and accessories are finished in Eco Black.

Sizes

Vertical files are 28 $\frac{3}{4}$ " deep and are available in the following sizes:

No. of Drawers	Letter Width	Legal Width	Exterior Height
2	15"	18"	26 $\frac{7}{8}$ "
3	15"	18"	38 $\frac{7}{8}$ "
4	15"	18"	50 $\frac{7}{8}$ "
5	15"	18"	55 $\frac{3}{8}$ "

Drawer Pulls

9900 Series fronts have full width integral pulls with enamel finish to match case fronts.

Verticals

How to order

1. Specify product number.
2. Specify finish color.
3. Specify options.

Product code key example V1828E-4FCP

V	vertical file
18	18" (legal) width
28	28" nominal depth
E	9900 Series
4F	number of file drawers
CP	with compressors™

Exterior cabinet heights are nominal. Actual heights (with glides fully recessed) are $\frac{1}{8}$ " less. **Vertical depths are nominal. Actual depth for 9900 Series are $\frac{3}{4}$ " more than noted.** File drawers accept hanging file folders. Bottom filing is accommodated in cabinets with compressors which are pre-installed in each drawer (suffix **CP**).

Counterweights

Counterweights are required for ALL freestanding units that are not anchored or ganged to other cabinets or bolted to walls/floor. See [Counterweight matrix](#).

Accessories

See [Vertical File Accessories](#) section for counterweights and accessories.

Lock option

Verticals come standard with lock. If lock is not required add suffix **'/NL'** after product number. Deduct \$57 list.

Finishes

Refer to [Finishes section](#) for color options. Drawer bodies and accessories are finished in Eco Black.

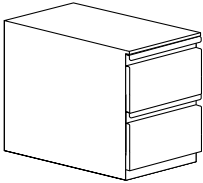
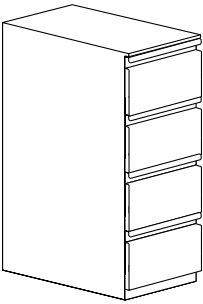
	Description	Part number	Exterior Height	Width	Case depth	Weight (lbs)	9900 series/ Neutral paint	Accent paint
	2-12" drawers Letter width	V1528E-2F V1528E-2FCP	26 $\frac{7}{8}$ " 26 $\frac{7}{8}$ "	15" 15"	28" 28"	115 115	\$953 \$985	+\$98 +\$101
	2-12" drawers Legal width	V1828E-2F V1828E-2FCP	26 $\frac{7}{8}$ " 26 $\frac{7}{8}$ "	18" 18"	28" 28"	120 120	\$1142 \$1179	+\$118 +\$121
	3-12" drawers Letter width	V1528E-3F V1528E-3FCP	38 $\frac{7}{8}$ " 38 $\frac{7}{8}$ "	15" 15"	28" 28"	120 120	\$1143 \$1195	+\$118 +\$123
	3-12" drawers Legal width	V1828E-3F V1828E-3FCP	38 $\frac{7}{8}$ " 38 $\frac{7}{8}$ "	18" 18"	28" 28"	125 125	\$1206 \$1255	+\$124 +\$128
	4-12" drawers Letter width	V1528E-4F V1528E-4FCP	50 $\frac{7}{8}$ " 50 $\frac{7}{8}$ "	15" 15"	28" 28"	125 125	\$1430 \$1496	+\$144 +\$152
	4-12" drawers Legal width	V1828E-4F V1828E-4FCP	50 $\frac{7}{8}$ " 50 $\frac{7}{8}$ "	18" 18"	28" 28"	130 130	\$1457 \$1524	+\$147 +\$154
	5-10.5" drawers Letter width	V1528E-5F V1528E-5FCP	55 $\frac{3}{8}$ " 55 $\frac{3}{8}$ "	15" 15"	28" 28"	130 130	\$1693 \$1774	+\$172 +\$180
	5-10.5" drawers Legal width	V1828E-5F V1828E-5FCP	55 $\frac{3}{8}$ " 55 $\frac{3}{8}$ "	18" 18"	28" 28"	135 135	\$1725 \$1803	+\$175 +\$182



Build-Ups

US Price List • June 2021

No Match!

OS Build-Ups allow you to create a completely customized storage solution, from the ground up. Simply select your case size, choose your interior components and then add some accessories. Cases and interior components are available in a variety of color combinations to create any look you need.

ANSI/BIFMA

With the addition of counterweights where appropriate, lateral files meet all ANSI/BIFMA specifications.

Construction

Lateral files and hinged door cabinets are of all-welded construction using 20 and 22 gauge high quality, tension leveled, cold rolled steel. The steel gauges selected for drawer fronts, bodies and accessories ensure the highest quality, durability and performance for all components.

Construction features & benefits

- All interiors are modular and interchangeable so that cabinets can be retrofitted with new accessories and interiors as required.
- Corners are strengthened with a reinforcing gusset and are welded at junction of top and case fronts, eliminating horizontal lines for a cleaner, flush appearance on the face of the cabinet.
- Full width pulls allow lift-up doors and drawers to be opened from any position.
- Rigid construction allows lift-up doors to be picked up and receded smoothly from any point, eliminates deformation, ensures flush fit within the cabinet and improves lock performance.
- Lift-up door carrier mechanism has four nylon rollers, two on each side, for smooth receding action with no binding or snagging.
- Front leading edge of pullout shelves is beaded and rolled to provide grip for pullout action and to strengthen shelf; front leading edge of fixed shelf is flat for easy removal of material.
- Fully-progressive ball bearing suspensions are staged so that left and right sides work in unison. This provides smooth drawer operation with minimum force.
- Special "claw-like" device incorporated in suspensions "grips" the fixed section of the suspension arm preventing drawer bounce-back or creep when drawer is closed.
- Lock bars operate vertically on both sides of the cabinet for maximum security.
- Lock fingers are configured with right angle bend upward, not downward, so that lift-up doors cannot be pulled down to disengage fingers from door slots and be forced to circumvent lock system.
- Plastic buttons in side gables of case where top sections of lift-up doors recede into the cabinet eliminate metal-to-metal contact.
- Plastic buttons in the ends of each drawer and door front eliminates metal-to-metal contact between cabinet sides and closed drawers.
- Self-closing, 110° opening, European style cupboard hinges provide smooth hinged door operation. Hinges are not visible from the exterior of the cabinet.

Bases

Optional base aprons are available in 2 heights and are screwed to the underside of the cabinet. Bases may be easily added or changed on site. Cabinets are shipped with bases installed when ordered.

Counterweights

Counterweights are required for ALL freestanding units that are not anchored or ganged to other cabinets or bolted to walls/floor.

Safelock™

The patented Safelock mechanism provides complete security against accidental opening of two or more drawers simultaneously. When any drawer or single pullout shelf is extended, even fractionally, Safelock ensures that all other openings, except for the 3" and 4 1/2" drawers, immediately become inoperable. Safelock is standard on all lateral files. The only exceptions are the 3" and 4 1/2" drawers and the upper shelf in a two pullout shelf opening.

Drawer standard equipment

Pullout drawers and shelves have optional hangfile bars for side-to-side suspended filing. Fixed shelves have optional plate dividers. Additional optional accessories are available.

Glides

Overall heights are inclusive of metal glides. Heights may be increased up to 3/8" by extending standard glide. Glides are accessible from inside the cabinet when the bottom drawer is fully extended or removed and may be adjusted with a 1/4" socket driver.

Optional 1 1/2" stem glides are available. Specify separately and add \$30 list to the cabinet price. Requires field installation.

Locks

Cabinets come standard with lock. If lock is not required add suffix 'N/L' after product number. Deduct \$57 list per lock. For lock location, see diagrams at the front of this price list.

Note: 3" and 4 1/2" drawers, when located immediately above a case bottom, tie bar shelf or reference shelves cannot be locked.

Random keying is standard. Files may be ordered keyed alike. Specify. Locks feature removable core and are standard with two keys, one of which has a black neoprene plastic key cover.

Cabinets originally ordered as non-locking may be field installed with the addition of locking bars and a lock core. Please contact Office Specialty Client Services for required parts.

Master keys are available at \$51 list.

Lateral File Tops

Refer to [Accessories section](#) to order Laminate and Nuform tops.

Finishes

Refer to [Finishes section](#) of this price list. For lock finish options, refer to the front of this price list.

Drawer pulls

9900 Series fronts have full width integral pulls with enamel finish to match case fronts.

Case Height Matrix

Interior Height		Exterior Height	
in.	mm	in.	mm
15"	381	17 7/8"	454
16 1/2"	419	19 3/8"	492
18"	457	20 7/8"	530
19 1/2"	495	22 3/8"	568
21"	533	23 7/8"	606
22 1/2"	572	25 3/8"	645
24"	610	26 7/8"	683
25 1/2"	648	28 3/8"	721
27"	686	29 7/8"	759
28 1/2"	724	31 3/8"	797
30"	762	32 7/8"	835
31 1/2"	800	34 3/8"	873
33"	838	35 7/8"	911
34 1/2"	876	37 3/8"	949
36"	914	38 7/8"	987
37 1/2"	953	40 3/8"	1026
39"	991	41 7/8"	1064
40 1/2"	1029	43 3/8"	1102
42"	1067	44 7/8"	1140
43 1/2"	1105	46 3/8"	1178
45"	1143	47 7/8"	1216
46 1/2"	1181	49 3/8"	1254
48"	1219	50 7/8"	1292
49 1/2"	1257	52 3/8"	1330
51"	1295	53 7/8"	1368
52 1/2"	1334	55 3/8"	1407
54"	1372	56 7/8"	1445
55 1/2"	1410	58 3/8"	1483
57"	1448	59 7/8"	1521
58 1/2"	1486	61 3/8"	1559
60"	1524	62 7/8"	1597
61 1/2"	1562	64 3/8"	1635
63"	1600	65 7/8"	1673
64 1/2"	1638	67 3/8"	1711
66"	1676	68 7/8"	1749
67 1/2"	1715	70 3/8"	1788
69"	1753	71 7/8"	1826
70 1/2"	1791	73 3/8"	1864
72"	1829	74 7/8"	1902
73 1/2"	1867	76 3/8"	1940
75"	1905	77 7/8"	1978
76 1/2"	1943	79 3/8"	2016

How to order

1. Specify basic cabinet product number.
2. Specify cabinet interiors from TOP to BOTTOM.
3. Specify accessories, refer to [Accessories section](#).
4. Specify finish color.
5. Cabinets come standard with lock. If lock is not required add suffix '/NL' after product number. Deduct \$57 list

Product code key example

30-15E

- 30** cabinet width
15 cabinet interior clear height including tie bar
E 9900 Series

$\frac{5}{8}$ " glides are standard and can be used with or without base aprons. Total of interior components specified must equal interior case height. $1\frac{1}{2}$ " for structural tie bar must be added to interior components that total $61\frac{1}{2}$ " or more.

Cabinets are 18" in depth.

Tie bar is not required:

- For 9900 Series if build-up includes hinged door insert, fixed shelf or SuperStor™ insert in the top opening.

Note: Exterior cabinet heights shown above are nominal. Actual heights, with glides fully recessed, are $\frac{1}{8}$ " less. Cabinets are 18" deep.

A standard $1\frac{1}{2}$ " structural tie bar will be provided by the factory in all cabinets with $64\frac{3}{8}$ " or more exterior height. The tie bar is usually positioned ± 36 " from the bottom of the cabinet.

Counterweights

Counterweights are required for ALL freestanding units that are not anchored or ganged to other cabinets or bolted to walls/floor. See [Counterweight matrix](#).

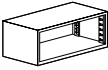
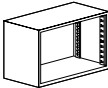
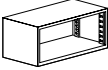
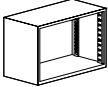
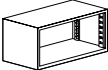
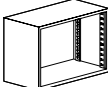
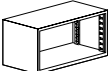
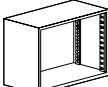
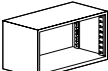
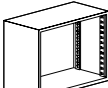
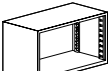
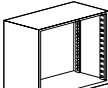
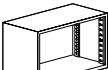
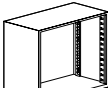
	Interior height	Exterior height	Part number	Neutral paint/ base price	Accent paint		Interior height	Exterior height	Part number	Neutral paint/ base price	Accent paint
	15"	17 $\frac{7}{8}$ "	30-15E 36-15E 42-15E	\$481 \$529 \$569	+\$51 +\$56 +\$59		25 $\frac{1}{2}$ "	28 $\frac{3}{8}$ "	30-25.5E 36-25.5E 42-25.5E	\$557 \$563 \$611	+\$58 +\$59 +\$63
	16 $\frac{1}{2}$ "	19 $\frac{3}{8}$ "	30-16.5E 36-16.5E 42-16.5E	\$496 \$538 \$571	+\$52 +\$57 +\$59		27"	29 $\frac{7}{8}$ "	30-27E 36-27E 42-27E	\$567 \$582 \$648	+\$59 +\$60 +\$66
	18"	20 $\frac{7}{8}$ "	30-18E 36-18E 42-18E	\$502 \$539 \$574	+\$52 +\$57 +\$60		28 $\frac{1}{2}$ "	31 $\frac{3}{8}$ "	30-28.5E 36-28.5E 42-28.5E	\$582 \$603 \$678	+\$60 +\$62 +\$70
	19 $\frac{1}{2}$ "	22 $\frac{3}{8}$ "	30-19.5E 36-19.5E 42-19.5E	\$504 \$540 \$582	+\$53 +\$57 +\$60		30"	32 $\frac{7}{8}$ "	30-30E 36-30E 42-30E	\$583 \$626 \$708	+\$60 +\$64 +\$72
	21"	23 $\frac{7}{8}$ "	30-21E 36-21E 42-21E	\$505 \$542 \$584	+\$53 +\$57 +\$60		31 $\frac{1}{2}$ "	34 $\frac{3}{8}$ "	30-31.5E 36-31.5E 42-31.5E	\$584 \$628 \$709	+\$60 +\$64 +\$72
	22 $\frac{1}{2}$ "	25 $\frac{3}{8}$ "	30-22.5E 36-22.5E 42-22.5E	\$507 \$544 \$587	+\$53 +\$57 +\$61		33"	35 $\frac{7}{8}$ "	30-33E 36-33E 42-33E	\$587 \$632 \$718	+\$61 +\$65 +\$73
	24"	26 $\frac{7}{8}$ "	30-24E 36-24E 42-24E	\$508 \$546 \$591	+\$53 +\$57 +\$61		34 $\frac{1}{2}$ "	37 $\frac{3}{8}$ "	30-34.5E 36-34.5E 42-34.5E	\$591 \$639 \$729	+\$61 +\$65 +\$74

How to order

1. Specify basic cabinet product number.
2. Specify cabinet interiors from TOP to BOTTOM.
3. Specify accessories, refer to [Accessories section](#).
4. Specify finish color.
5. Cabinets come standard with lock. If lock is not required add suffix '/NL' after product number. Deduct \$57 list

Product code key example

30-15E

- 30** cabinet width
15 cabinet interior clear height including tie bar
E 9900 Series

$\frac{5}{8}$ " glides are standard and can be used with or without base aprons. Total of interior components specified must equal interior case height. $1\frac{1}{2}$ " for structural tie bar must be added to interior components that total $61\frac{1}{2}$ " or more.

Cabinets are 18" in depth.

Tie bar is not required:

- For 9900 Series if build-up includes hinged door insert, fixed shelf or SuperStor™ insert in the top opening.

Note: Exterior cabinet heights shown above are nominal. Actual heights, with glides fully recessed, are $\frac{1}{8}$ " less. Cabinets are 18" deep.

A standard $1\frac{1}{2}$ " structural tie bar will be provided by the factory in all cabinets with $64\frac{3}{8}$ " or more exterior height. The tie bar is usually positioned ± 36 " from the bottom of the cabinet.

Counterweights

Counterweights are required for ALL freestanding units that are not anchored or ganged to other cabinets or bolted to walls/floor. See [Counterweight matrix](#).

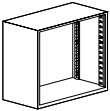
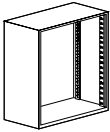
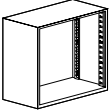
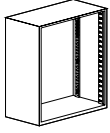
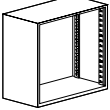
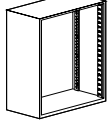
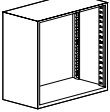
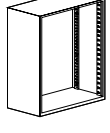
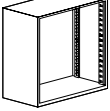
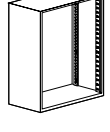
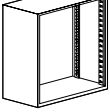
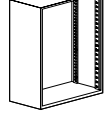
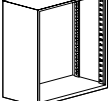
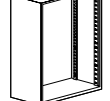
	Interior height	Exterior height	Part number	Neutral paint/ base price	Accent point		Interior height	Exterior height	Part number	Neutral paint/ base price	Accent point
	36"	38 $\frac{7}{8}$ "	30-36E 36-36E 42-36E	\$593 \$641 \$729	+\$61 +\$65 +\$74		46 $\frac{1}{2}$ "	49 $\frac{3}{8}$ "	30-46.5E 36-46.5E 42-46.5E	\$632 \$790 \$924	+\$65 +\$83 +\$96
	37 $\frac{1}{2}$ "	40 $\frac{3}{8}$ "	30-37.5E 36-37.5E 42-37.5E	\$604 \$663 \$762	+\$62 +\$67 +\$79		48"	50 $\frac{7}{8}$ "	30-48E 36-48E 42-48E	\$633 \$791 \$925	+\$65 +\$83 +\$96
	39"	41 $\frac{7}{8}$ "	30-39E 36-39E 42-39E	\$612 \$685 \$790	+\$63 +\$70 +\$83		49 $\frac{1}{2}$ "	52 $\frac{3}{8}$ "	30-49.5E 36-49.5E 42-49.5E	\$648 \$792 \$926	+\$66 +\$83 +\$96
	40 $\frac{1}{2}$ "	43 $\frac{3}{8}$ "	30-40.5E 36-40.5E 42-40.5E	\$619 \$713 \$825	+\$64 +\$73 +\$86		51"	53 $\frac{7}{8}$ "	30-51E 36-51E 42-51E	\$664 \$795 \$938	+\$67 +\$84 +\$97
	42"	44 $\frac{7}{8}$ "	30-42E 36-42E 42-42E	\$627 \$738 \$859	+\$64 +\$76 +\$89		52 $\frac{1}{2}$ "	55 $\frac{3}{8}$ "	30-52.5E 36-52.5E 42-52.5E	\$665 \$799 \$948	+\$67 +\$84 +\$98
	43 $\frac{1}{2}$ "	46 $\frac{3}{8}$ "	30-43.5E 36-43.5E 42-43.5E	\$628 \$766 \$896	+\$64 +\$79 +\$92		54"	56 $\frac{7}{8}$ "	30-54E 36-54E 42-54E	\$677 \$807 \$951	+\$69 +\$85 +\$98
	45"	47 $\frac{7}{8}$ "	30-45E 36-45E 42-45E	\$630 \$788 \$923	+\$64 +\$83 +\$96		55 $\frac{1}{2}$ "	58 $\frac{3}{8}$ "	30-55.5E 36-55.5E 42-55.5E	\$678 \$813 \$962	+\$70 +\$85 +\$99

How to order

1. Specify basic cabinet product number.
2. Specify cabinet interiors from TOP to BOTTOM.
3. Specify accessories, refer to [Accessories section](#).
4. Specify finish color.
5. Cabinets come standard with lock. If lock is not required add suffix '/NL' after product number. Deduct \$57 list

Product code key example

30-15E

- 30** cabinet width
15 cabinet interior clear height including tie bar
E 9900 Series

$\frac{5}{8}$ " glides are standard and can be used with or without base aprons. Total of interior components specified must equal interior case height. $1\frac{1}{2}$ " for structural tie bar must be added to interior components that total $61\frac{1}{2}$ " or more.

Cabinets are 18" in depth.

Tie bar is not required:

- For 9900 Series if build-up includes hinged door insert, fixed shelf or SuperStor™ insert in the top opening.

Note: Exterior cabinet heights shown above are nominal. Actual heights, with glides fully recessed, are $\frac{1}{8}$ " less. Cabinets are 18" deep.

A standard $1\frac{1}{2}$ " structural tie bar will be provided by the factory in all cabinets with $64\frac{3}{8}$ " or more exterior height. The tie bar is usually positioned ± 36 " from the bottom of the cabinet.

Counterweights

Counterweights are required for ALL freestanding units that are not anchored or ganged to other cabinets or bolted to walls/floor. See [Counterweight matrix](#).

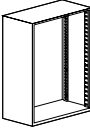
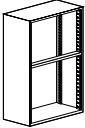
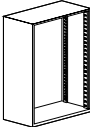
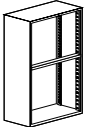
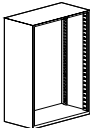
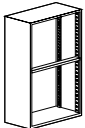
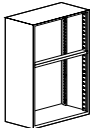
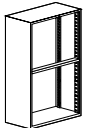
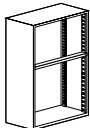
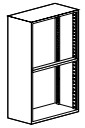
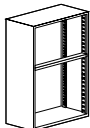
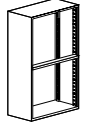
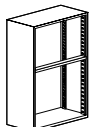
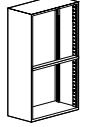
	Interior height	Exterior height	Part number	Neutral paint/ base price	Accent paint		Interior height	Exterior height	Part number	Neutral paint/ base price	Accent paint
	57"	59 $\frac{7}{8}$ "	30-57E 36-57E 42-57E	\$681 \$821 \$970	+\$70 +\$86 +\$100		67 $\frac{1}{2}$ "	70 $\frac{3}{8}$ "	30-67.5E 36-67.5E 42-67.5E	\$775 \$933 \$1080	+\$81 +\$96 +\$110
	58 $\frac{1}{2}$ "	61 $\frac{3}{8}$ "	30-58.5E 36-58.5E 42-58.5E	\$682 \$822 \$971	+\$70 +\$86 +\$100		69"	71 $\frac{7}{8}$ "	30-69E 36-69E 42-69E	\$794 \$962 \$1110	+\$84 +\$99 +\$114
	60"	62 $\frac{7}{8}$ "	30-60E 36-60E 42-60E	\$684 \$823 \$972	+\$70 +\$86 +\$100		70 $\frac{1}{2}$ "	73 $\frac{3}{8}$ "	30-70.5E 36-70.5E 42-70.5E	\$822 \$989 \$1142	+\$86 +\$101 +\$118
	61 $\frac{1}{2}$ "	64 $\frac{3}{8}$ "	30-61.5E 36-61.5E 42-61.5E	\$685 \$825 \$974	+\$70 +\$86 +\$100		72"	74 $\frac{7}{8}$ "	30-72E 36-72E 42-72E	\$853 \$1021 \$1168	+\$89 +\$104 +\$120
	63"	65 $\frac{7}{8}$ "	30-63E 36-63E 42-63E	\$705 \$852 \$996	+\$72 +\$89 +\$102		73 $\frac{1}{2}$ "	76 $\frac{3}{8}$ "	30-73.5E 36-73.5E 42-73.5E	\$875 \$1051 \$1207	+\$91 +\$107 +\$124
	64 $\frac{1}{2}$ "	67 $\frac{3}{8}$ "	30-64.5E 36-64.5E 42-64.5E	\$723 \$875 \$1024	+\$73 +\$91 +\$104		75"	77 $\frac{7}{8}$ "	30-75E 36-75E 42-75E	\$914 \$1086 \$1237	+\$94 +\$111 +\$127
	66"	68 $\frac{7}{8}$ "	30-66E 36-66E 42-66E	\$746 \$907 \$1050	+\$76 +\$93 +\$107		76 $\frac{1}{2}$ "	79 $\frac{3}{8}$ "	30-76.5E 36-76.5E	\$949 \$1118	+\$98 +\$114

How to order

1. Specify basic cabinet product number.
2. Specify cabinet interiors from TOP to BOTTOM.
3. Specify accessories, refer to [Accessories section](#).
4. Specify finish color.
5. Cabinets come standard with lock. If lock is not required add suffix '/NL' after product number. Deduct \$57 list

Product code key example

30-63ESB

- 30** cabinet width
63 cabinet interior clear height including sliding security bar
E 9900 Series
SB sliding security bar

Counterweights

Counterweights are required for ALL freestanding units that are not anchored or ganged to other cabinets or bolted to walls/floor. See [Counterweight matrix](#).

Finishes

Refer to [Finishes section](#) for color options. Sliding security bar and hinges are the same finish as the case. Drawer bodies and accessories are finished in Eco Black.

Important

These are available in Storage Centers and 9900 Series only. Security lock bars cannot be field installed. Tie bar, filler panel, hinged door inserts and SuperStor™ inserts cannot be specified as cabinet interiors. Reference shelf cannot be positioned above or below the security bar.

The security lock base 1 1/2" high.

Note: Exterior cabinet heights shown are nominal. Actual heights, with glides fully recessed, are 1/8" less. Cabinets are 18" deep.

Cabinets come with piano style hinges, a 1 1/2" sliding security bar and a lock hook with double sided tape.

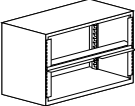
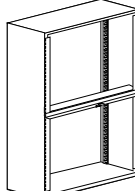
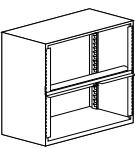
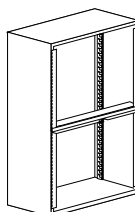
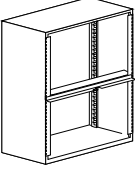
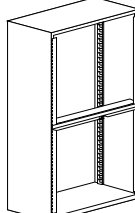
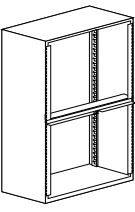
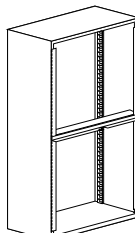
	Interior height	Exterior height	Part number	Neutral paint/ base price	Accent point		Interior height	Exterior height	Part number	Neutral paint/ base price	Accent point
	25 1/2"	25 3/8"	30-25.5ESB 36-25.5ESB 42-25.5ESB	\$863 \$869 \$916	+\$89 +\$90 +\$94		63"	65 7/8"	30-63ESB 36-63ESB 42-63ESB	\$1113 \$1259 \$1403	+\$114 +\$129 +\$142
	37 1/2"	40 3/8"	30-37.5ESB 36-37.5ESB 42-37.5ESB	\$947 \$1006 \$1104	+\$98 +\$103 +\$112		67 1/2"	70 3/8"	30-67.5ESB 36-67.5ESB 42-67.5ESB	\$1193 \$1349 \$1497	+\$123 +\$137 +\$152
	49 1/2"	52 3/8"	30-49.5ESB 36-49.5ESB 42-49.5ESB	\$1023 \$1167 \$1302	+\$104 +\$120 +\$132		73 1/2"	76 3/8"	30-73.5ESB 36-73.5ESB 42-73.5ESB	\$1308 \$1482 \$1639	+\$133 +\$151 +\$167
	61 1/2"	64 3/8"	30-61.5ESB 36-61.5ESB 42-61.5ESB	\$1089 \$1228 \$1376	+\$111 +\$126 +\$140		76 1/2"	79 3/8"	30-76.5ESB 36-76.5ESB	\$1395 \$1563	+\$141 +\$160

How to order

1. Specify basic cabinet product number followed by drawer and shelf interiors with their accessories (see [Accessories section](#)) in order from TOP to BOTTOM, indicating which interior is in the top position. Interiors may be specified in almost any combination to make up the TOTAL INTERIOR HEIGHT.
2. Specify finish color

Product code key example

3FFE-36

- 3** module height
FF fixed front drawer
E 9900 Series
36 width

Finishes

Refer to [Finishes section](#) for color options. Drawer bodies and accessories are finished in Eco Black.

Optional Accessories

Accessories are optional for all items on this page. Available accessories are outlined with each set of product codes.

Visit the Lateral File [Accessories section](#) for full accessory details.

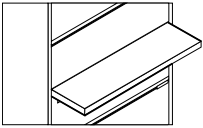
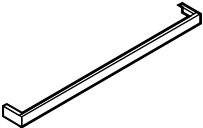
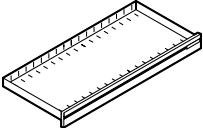
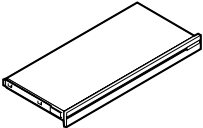
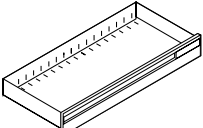
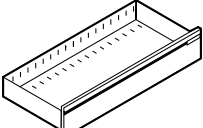
Description	Part number	Exterior Height	Width	Weight (lbs)	9900 series/ Neutral paint	Accent paint														
 <p>1.5" Opening Interiors 1.5" reference shelf (can replace tie bar in units designated with tie bar) Cannot be positioned in top opening, or below hinged door inserts</p>	RF-30	1.5"	30"	8	\$139	+\$17														
	RF-36	1.5"	36"	10	\$141	+\$17														
	RF-42	1.5"	42"	12	\$144	+\$18														
 <p>1.5" filler panel Cannot be positioned above or below a reference shelf.</p>	1.5F-30	1.5"	30"	1	\$64	+\$10														
	1.5F-36	1.5"	36"	1	\$69	+\$10														
	1.5F-42	1.5"	42"	1	\$71	+\$10														
 <p>3" Opening Interiors 3" fixed front drawer Note: 3" drawer, when located immediately above a case bottom, tie bar or reference shelf cannot be locked.</p>	3FFE-30	3"	30"	10	\$214	+\$24														
	3FFE-36	3"	36"	12	\$226	+\$25														
	3FFE-42	3"	42"	14	\$228	+\$25														
	<table border="1"> <thead> <tr> <th>Optional Accessories</th> <th>Part #</th> <th>Price</th> </tr> </thead> <tbody> <tr> <td>Plate Divider</td> <td>DVP-3</td> <td>+\$21</td> </tr> </tbody> </table>	Optional Accessories	Part #	Price	Plate Divider	DVP-3	+\$21													
Optional Accessories	Part #	Price																		
Plate Divider	DVP-3	+\$21																		
 <p>3" fixed front drawer with laminate shelf Note: 3" drawer, when located immediately above a case bottom, tie bar or reference shelf cannot be locked.</p>	3FFE/PL-30	3"	30"	26	\$432	+\$46														
	3FFE/PL-36	3"	36"	32	\$449	+\$48														
	3FFE/PL-42	3"	42"	39	\$496	+\$52														
 <p>4.5" Opening Interiors 4.5" fixed front drawer</p>	4.5FFE-30	4.5"	30"	10	\$214	+\$24														
	4.5FFE-36	4.5"	36"	12	\$226	+\$25														
	4.5FFE-42	4.5"	42"	14	\$228	+\$25														
	<table border="1"> <thead> <tr> <th>Optional Accessories</th> <th>Part #</th> <th>Price</th> </tr> </thead> <tbody> <tr> <td>Plate Divider</td> <td>DVP-3</td> <td>+\$21</td> </tr> </tbody> </table>	Optional Accessories	Part #	Price	Plate Divider	DVP-3	+\$21													
Optional Accessories	Part #	Price																		
Plate Divider	DVP-3	+\$21																		
 <p>6" Opening Interiors 6" fixed front drawer. Optional drawer filler is recommended. See Lateral Accessories.</p>	6FFE-30	6"	30"	12	\$226	+\$25														
	6FFE-36	6"	36"	16	\$253	+\$27														
	6FFE-42	6"	42"	17	\$281	+\$30														
	<table border="1"> <thead> <tr> <th>Optional Accessories</th> <th>Part #</th> <th>Price</th> </tr> </thead> <tbody> <tr> <td>Plate Divider</td> <td>DVP6-9</td> <td>+\$21</td> </tr> <tr> <td>Drawer Filler</td> <td>DF30</td> <td>+\$26</td> </tr> <tr> <td></td> <td>DF36</td> <td>+\$27</td> </tr> <tr> <td></td> <td>DF36</td> <td>+\$31</td> </tr> </tbody> </table> <p><small>*note: to be used in conjunction with the DVP6-9</small></p>	Optional Accessories	Part #	Price	Plate Divider	DVP6-9	+\$21	Drawer Filler	DF30	+\$26		DF36	+\$27		DF36	+\$31				
Optional Accessories	Part #	Price																		
Plate Divider	DVP6-9	+\$21																		
Drawer Filler	DF30	+\$26																		
	DF36	+\$27																		
	DF36	+\$31																		

How to order

1. Specify basic cabinet product number followed by drawer and shelf interiors with their accessories (see [Accessories section](#)) in order from TOP to BOTTOM, indicating which interior is in the top position. Interiors may be specified in almost any combination to make up the TOTAL INTERIOR HEIGHT.
2. Specify finish color

Product code key example 9FFE-36

- 9** module height
FF fixed front drawer
E 9900 Series
36 width

Finishes

Refer to [Finishes section](#) for color options. Drawer bodies and accessories are finished in Eco Black.

Optional Accessories

Accessories are optional for all items on this page. Available accessories are outlined with each set of product codes.

Note: Sliding Rails must be used in conjunction with Hangfile Bars, EDP Kits or X-ray Kits.

Visit the Lateral File [Accessories section](#) for full accessory details.

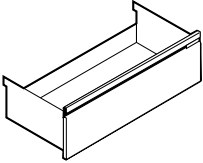
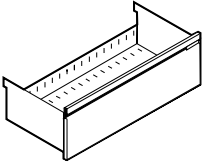
Description	Part number	Exterior Height	Width	Weight (lbs)	9900 series/ Neutral paint	Accent paint
 <p>7.5" Opening Interiors 7.5" fixed front drawer. Optional drawer filler is recommended. See Lateral Accessories.</p>	7.5FFE-30	7.5"	30"	13	\$251	+\$27
	7.5FFE-36	7.5"	36"	17	\$279	+\$30
	7.5FFE-42	7.5"	42"	18	\$312	+\$33
		Optional Accessories		Part #	Price	
		Plate Divider		DVP6-9	+ \$21	
		Drawer Filler		DF30	+ \$26	
				DF36	+ \$27	
				DF36	+ \$31	
<small>*note: to be used in conjunction with the DVP6-9</small>						
 <p>9" Opening Interiors 9" fixed front drawer</p>	9FFE-30	9"	30"	14	\$251	+\$27
	9FFE-36	9"	36"	17	\$279	+\$30
	9FFE-42	9"	42"	19	\$312	+\$33
		Optional Accessories		Part #	Price	
		Plate Divider		DVP6-9	+ \$21	
 <p>10.5" Opening Interiors 10.5" fixed front drawer Note: Not to be used for bottom filing</p>	10.5FFE-30	10.5"	30"	14	\$254	+\$27
	10.5FFE-36	10.5"	36"	17	\$289	+\$31
	10.5FFE-42	10.5"	42"	19	\$324	+\$34
		Optional Accessories		Part #	Price	
		Hangfile Bars (30", 36" & 42")		HF-xx	+ \$45	
		Sliding Rails <small>*note: two rails are required per drawer</small>		SR	+ \$16	
		Legal to Letter Adapter (30", 36" & 42")		LL-xx	+ \$25	
 <p>10.5" Opening Interiors 10.5" fixed front drawer to accommodate non-suspended filing</p>	10.5FFE-30BF	10.5"	30"	14	\$254	+\$27
	10.5FFE-36BF	10.5"	36"	17	\$289	+\$31
	10.5FFE-42BF	10.5"	42"	20	\$324	+\$34
		Optional Accessories		Part #	Price	
		Plate Divider		DVP	+ \$21	
		Legal to Letter Adapter (30", 36" & 42")		LL-xx	+ \$25	
 <p>10.5" slotted bottom fixed front drawer with raised back</p>	10.5FFE-30BFRB	10.5"	30"	14	\$277	+\$30
	10.5FFE-36BFRB	10.5"	36"	17	\$314	+\$33
	10.5FFE-42BFRB	10.5"	42"	20	\$350	+\$36
		Optional Accessories		Part #	Price	
		Plate Divider		DVP	+ \$21	
		Legal to Letter Adapter (30", 36" & 42")		LL-xx	+ \$25	

How to order

- Specify basic cabinet product number followed by drawer and shelf interiors with their accessories (see [Accessories section](#)) in order from TOP to BOTTOM, indicating which interior is in the top position. Interiors may be specified in almost any combination to make up the TOTAL INTERIOR HEIGHT.
- Specify finish color

Product code key example

12FFE-36

12 module height
FF fixed front
E 9900 Series
36 width

Finishes

Refer to [Finishes section](#) for color options. Drawer bodies and accessories are finished in Eco Black.

Optional Accessories

Accessories are optional for all items on this page. Available accessories are outlined with each set of product codes.

Note: Sliding Rails must be used in conjunction with Hangfile Bars, EDP Kits or X-ray Kits.

Visit the Lateral File [Accessories section](#) for full accessory details.

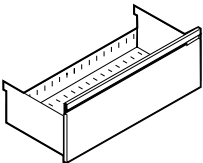
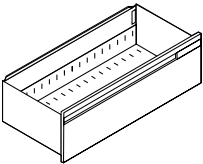
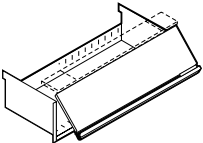
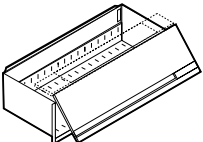
Description	Part number	Exterior Height	Width	Weight (lbs)	9900 series/ Neutral paint	Accent paint
 12" Opening Interiors 12" fixed front drawer	12FFE-30	12"	30"	15	\$254	+\$27
	12FFE-36	12"	36"	18	\$289	+\$31
	12FFE-42	12"	42"	21	\$324	+\$34
		Optional Accessories		Part #	Price	
		Hangfile Bars (30", 36" & 42")		HF-xx	+ \$45	
		Sliding Rails *note: two rails are required per drawer		SR	+ \$16	
		Plate Divider		DVP	+ \$21	
		Legal to Letter Adapter (30", 36" & 42")		LL-xx	+ \$25	
 12" fixed front drawer with raised back	12FFE-30RB	12"	30"	15	\$277	+\$30
	12FFE-36RB	12"	36"	18	\$314	+\$33
	12FFE-42RB	12"	42"	21	\$350	+\$36
		Optional Accessories		Part #	Price	
		Hangfile Bars (30", 36" & 42")		HF-xx	+ \$45	
		Sliding Rails *note: two rails are required per drawer		SR	+ \$16	
		Plate Divider		DVP	+ \$21	
		Legal to Letter Adapter (30", 36" & 42")		LL-xx	+ \$25	
 12" lift-up door with pullout shelf	12LUE/PS-30	12"	30"	20	\$254	+\$27
	12LUE/PS-36	12"	36"	24	\$289	+\$31
	12LUE/PS-42	12"	42"	29	\$324	+\$34
		Optional Accessories		Part #	Price	
		Hangfile Bars (30", 36" & 42")		HF-xx	+ \$45	
		Sliding Rails *note: two rails are required per drawer		SR	+ \$16	
		Plate Divider		DVP	+ \$21	
		Legal to Letter Adapter (30", 36" & 42")		LL-xx	+ \$25	
 12" lift-up door with pullout shelf with raised back	12LUE/PS-30RB	12"	30"	20	\$277	+\$30
	12LUE/PS-36RB	12"	36"	24	\$314	+\$33
	12LUE/PS-42RB	12"	42"	29	\$350	+\$36
		Optional Accessories		Part #	Price	
		Hangfile Bars (30", 36" & 42")		HF-xx	+ \$45	
		Sliding Rails *note: two rails are required per drawer		SR	+ \$16	
		Plate Divider		DVP	+ \$21	
		Legal to Letter Adapter (30", 36" & 42")		LL-xx	+ \$25	

How to order

- Specify basic cabinet product number followed by drawer and shelf interiors with their accessories (see [Accessories section](#)) in order from TOP to BOTTOM, indicating which interior is in the top position. Interiors may be specified in almost any combination to make up the TOTAL INTERIOR HEIGHT.
- Specify finish color

Product code key example

12LUE-36

12 module height
LU lift up front
E 9900 Series
36 width

Finishes

Refer to [Finishes section](#) for color options. Drawer bodies and accessories are finished in Eco Black.

Optional Accessories

Accessories are optional for all items on this page. Available accessories are outlined with each set of product codes.

Note: Sliding Rails must be used in conjunction with Hangfile Bars, EDP Kits or X-ray Kits.

Visit the Lateral File [Accessories section](#) for full accessory details.

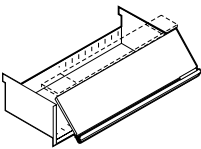
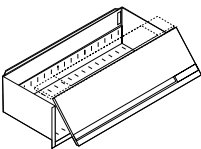
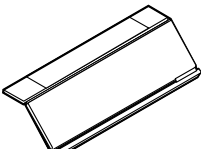
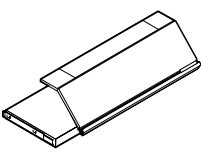
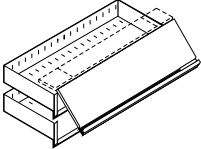
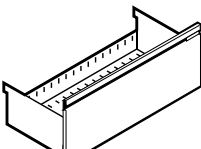
Description	Part number	Exterior Height	Width	Weight (lbs)	9900 series/ Neutral paint	Accent point																		
	12LUE/FS-30	12"	30"	19	\$245	+\$26																		
	12LUE/FS-36	12"	36"	22	\$272	+\$30																		
	12LUE/FS-42	12"	42"	27	\$310	+\$33																		
	<table border="1"> <thead> <tr> <th>Optional Accessories</th> <th>Part #</th> <th>Price</th> </tr> </thead> <tbody> <tr> <td>Plate Divider</td> <td>DVP</td> <td>+ \$21</td> </tr> <tr> <td>Legal to Letter Adapter (30", 36" & 42")</td> <td>LL-xx</td> <td>+ \$25</td> </tr> </tbody> </table>						Optional Accessories	Part #	Price	Plate Divider	DVP	+ \$21	Legal to Letter Adapter (30", 36" & 42")	LL-xx	+ \$25									
Optional Accessories	Part #	Price																						
Plate Divider	DVP	+ \$21																						
Legal to Letter Adapter (30", 36" & 42")	LL-xx	+ \$25																						
	12LUE/FS-30RB	12"	30"	19	\$264	+\$29																		
	12LUE/FS-36RB	12"	36"	22	\$293	+\$32																		
	12LUE/FS-42RB	12"	42"	27	\$336	+\$35																		
	<table border="1"> <thead> <tr> <th>Optional Accessories</th> <th>Part #</th> <th>Price</th> </tr> </thead> <tbody> <tr> <td>Plate Divider</td> <td>DVP</td> <td>+ \$21</td> </tr> <tr> <td>Legal to Letter Adapter (30", 36" & 42")</td> <td>LL-xx</td> <td>+ \$25</td> </tr> </tbody> </table>						Optional Accessories	Part #	Price	Plate Divider	DVP	+ \$21	Legal to Letter Adapter (30", 36" & 42")	LL-xx	+ \$25									
Optional Accessories	Part #	Price																						
Plate Divider	DVP	+ \$21																						
Legal to Letter Adapter (30", 36" & 42")	LL-xx	+ \$25																						
	12LUE-30	12"	30"	11	\$125	+\$16																		
	12LUE-36	12"	36"	14	\$144	+\$18																		
	12LUE-42	12"	42"	17	\$165	+\$19																		
	12LUE/PL-30	12"	30"	35	\$555	+\$58																		
	12LUE/PL-36	12"	36"	44	\$610	+\$63																		
	12LUE/PL-42	12"	42"	52	\$667	+\$69																		
	12LUE/66PS-30	12"	30"	22	\$430	+\$46																		
	12LUE/66PS-36	12"	36"	27	\$466	+\$49																		
	12LUE/66PS-42	12"	42"	33	\$510	+\$53																		
	<table border="1"> <thead> <tr> <th>Optional Accessories</th> <th>Part #</th> <th>Price</th> </tr> </thead> <tbody> <tr> <td>Plate Divider</td> <td>DVP</td> <td>+ \$21</td> </tr> </tbody> </table>						Optional Accessories	Part #	Price	Plate Divider	DVP	+ \$21												
Optional Accessories	Part #	Price																						
Plate Divider	DVP	+ \$21																						
	13.5FFE-30	13.5"	30"	16	\$293	+\$32																		
	13.5FFE-36	13.5"	36"	19	\$337	+\$35																		
	13.5FFE-42	13.5"	42"	22	\$374	+\$39																		
	<table border="1"> <thead> <tr> <th>Optional Accessories</th> <th>Part #</th> <th>Price</th> </tr> </thead> <tbody> <tr> <td>Hangfile Bars (30", 36" & 42")</td> <td>HF-xx</td> <td>+ \$45</td> </tr> <tr> <td>Sliding Rails *note: two rails are required per drawer</td> <td>SR</td> <td>+ \$16</td> </tr> <tr> <td>Plate Divider</td> <td>DVP</td> <td>+ \$21</td> </tr> <tr> <td>Legal to Letter Adapter (30", 36" & 42")</td> <td>LL-xx</td> <td>+ \$25</td> </tr> <tr> <td>EDP Kit (30", 36" & 42")</td> <td>EDPxx</td> <td>+ \$81</td> </tr> </tbody> </table>						Optional Accessories	Part #	Price	Hangfile Bars (30", 36" & 42")	HF-xx	+ \$45	Sliding Rails *note: two rails are required per drawer	SR	+ \$16	Plate Divider	DVP	+ \$21	Legal to Letter Adapter (30", 36" & 42")	LL-xx	+ \$25	EDP Kit (30", 36" & 42")	EDPxx	+ \$81
	Optional Accessories	Part #	Price																					
	Hangfile Bars (30", 36" & 42")	HF-xx	+ \$45																					
Sliding Rails *note: two rails are required per drawer	SR	+ \$16																						
Plate Divider	DVP	+ \$21																						
Legal to Letter Adapter (30", 36" & 42")	LL-xx	+ \$25																						
EDP Kit (30", 36" & 42")	EDPxx	+ \$81																						

How to order

- Specify basic cabinet product number followed by drawer and shelf interiors with their accessories (see [Accessories section](#)) in order from TOP to BOTTOM, indicating which interior is in the top position. Interiors may be specified in almost any combination to make up the TOTAL INTERIOR HEIGHT.
- Specify finish color

Product code key example 13.5LUE/PS-36

13.5 module height
LU lift-up
E 9900 Series
PS pullout shelf
36 width

Finishes

Refer to [Finishes section](#) for color options. Drawer bodies and accessories are finished in Eco Black.

Optional Accessories

Accessories are optional for all items on this page. Available accessories are outlined with each set of product codes.

Note: Sliding Rails must be used in conjunction with Hangfile Bars, EDP Kits or X-Ray Kits.

Visit the Lateral File [Accessories section](#) for full accessory details.

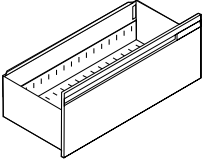
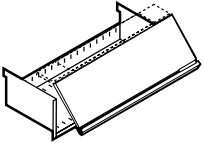
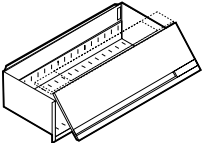
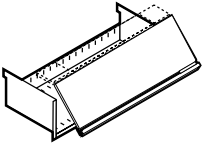
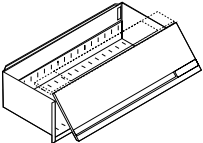
Description	Part number	Exterior Height	Width	Weight (lbs)	9900 series/ Neutral paint	Accent paint
	13.5FFE-30RB	13.5"	30"	16	\$317	+\$33
	13.5FFE-36RB	13.5"	36"	19	\$358	+\$37
	13.5FFE-42RB	13.5"	42"	22	\$399	+\$44
Optional Accessories		Part #	Price			
Hangfile Bars (30", 36" & 42")		HF-xx	+ \$45			
Sliding Rails *note: two rails are required per drawer		SR	+ \$16			
Plate Divider		DVP	+ \$21			
Legal to Letter Adapter (30", 36" & 42")		LL-xx	+ \$25			
	13.5LUE/PS-30	13.5"	30"	21	\$293	+\$32
	13.5LUE/PS-36	13.5"	36"	25	\$337	+\$35
	13.5LUE/PS-42	13.5"	42"	29	\$374	+\$39
Optional Accessories		Part #	Price			
Hangfile Bars (30", 36" & 42")		HF-xx	+ \$45			
Sliding Rails *note: two rails are required per drawer		SR	+ \$16			
Plate Divider		DVP	+ \$21			
Legal to Letter Adapter (30", 36" & 42")		LL-xx	+ \$25			
EDP Kit (30", 36" & 42")		EDPxx	+ \$81			
	13.5LUE/PS-30RB	13.5"	30"	21	\$317	+\$33
	13.5LUE/PS-36RB	13.5"	36"	25	\$358	+\$37
	13.5LUE/PS-42RB	13.5"	42"	29	\$399	+\$44
Optional Accessories		Part #	Price			
Plate Divider		DVP	+ \$21			
Legal to Letter Adapter (30", 36" & 42")		LL-xx	+ \$25			
	13.5LUE/FS-30	13.5"	30"	20	\$254	+\$27
	13.5LUE/FS-36	13.5"	36"	23	\$295	+\$32
	13.5LUE/FS-42	13.5"	42"	27	\$344	+\$36
Optional Accessories		Part #	Price			
Plate Divider		DVP	+ \$21			
Legal to Letter Adapter (30", 36" & 42")		LL-xx	+ \$25			
	13.5LUE/FS-30RB	13.5"	30"	20	\$277	+\$30
	13.5LUE/FS-36RB	13.5"	36"	23	\$320	+\$34
	13.5LUE/FS-42RB	13.5"	42"	27	\$368	+\$39
Optional Accessories		Part #	Price			
Plate Divider		DVP	+ \$21			
Legal to Letter Adapter (30", 36" & 42")		LL-xx	+ \$25			

How to order

1. Specify basic cabinet product number followed by drawer and shelf interiors with their accessories (see [Accessories section](#)) in order from TOP to BOTTOM, indicating which interior is in the top position. Interiors may be specified in almost any combination to make up the TOTAL INTERIOR HEIGHT.
2. Specify finish color

Product code key example 13.5LUE/PL-36

- 13.5** module height
LU lift-up
E 9900 Series
PL laminate pullout shelf
36 width

Finishes

Refer to [Finishes section](#) for color options. Drawer bodies and accessories are finished in Eco Black.

Optional Accessories

Accessories are optional for all items on this page. Available accessories are outlined with each set of product codes.

Note: Sliding Rails must be used in conjunction with Hangfile Bars, EDP Kits or X-ray Kits.

Visit the Lateral File [Accessories section](#) for full accessory details.

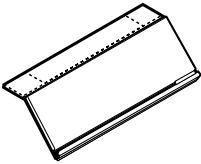
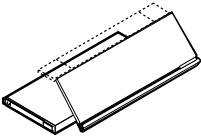
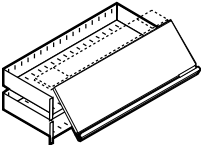
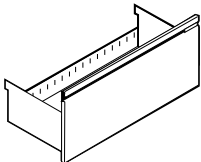
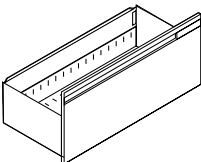
Description	Part number	Exterior Height	Width	Weight (lbs)	9900 series/ Neutral paint	Accent paint
	13.5LUE-30	13.5"	30"	12	\$162	+\$19
	13.5LUE-36	13.5"	36"	15	\$198	+\$22
	13.5LUE-42	13.5"	42"	18	\$220	+\$24
	13.5LUE/PL-30	13.5"	30"	36	\$555	+\$58
	13.5LUE/PL-36	13.5"	36"	45	\$610	+\$63
	13.5LUE/PL-42	13.5"	42"	54	\$667	+\$69
	13.5LUE/66PS-30	13.5"	30"	23	\$466	+\$49
	13.5LUE/66PS-36	13.5"	36"	28	\$505	+\$53
	13.5LUE/66PS-42	13.5"	42"	33	\$555	+\$58
Optional Accessories						
Plate Divider	DVP					+\$21
	15FFE-30	15"	30"	16	\$293	+\$32
	15FFE-36	15"	36"	19	\$337	+\$35
	15FFE-42	15"	42"	23	\$374	+\$39
Optional Accessories						
Hangfile Bars (30", 36" & 42")	HF-xx					+\$45
Sliding Rails *note: two rails are required per drawer	SR					+\$16
Plate Divider	DVP					+\$21
Legal to Letter Adapter (30", 36" & 42")	LL-xx					+\$25
EDP Kit (30", 36" & 42")	EDPxx					+\$81
	15FFE-30RB	15"	30"	16	\$317	+\$33
	15FFE-36RB	15"	36"	19	\$358	+\$37
	15FFE-42RB	15"	42"	23	\$399	+\$44
Optional Accessories						
Hangfile Bars (30", 36" & 42")	HF-xx					+\$45
Sliding Rails *note: two rails are required per drawer	SR					+\$16
Plate Divider	DVP					+\$21
Legal to Letter Adapter (30", 36" & 42")	LL-xx					+\$25

How to order

1. Specify basic cabinet product number followed by drawer and shelf interiors with their accessories (see [Accessories section](#)) in order from TOP to BOTTOM, indicating which interior is in the top position. Interiors may be specified in almost any combination to make up the TOTAL INTERIOR HEIGHT.
2. Specify finish color

Product code key example

15LUE/PS-36

15 module height
LU lift-up
E 9900 Series
PS pullout shelf
36 width

Finishes

Refer to [Finishes section](#) for color options. Drawer bodies and accessories are finished in Eco Black.

Optional Accessories

Accessories are optional for all items on this page. Available accessories are outlined with each set of product codes.

Note: Sliding Rails must be used in conjunction with Hangfile Bars, EDP Kits or X-ray Kits.

Visit the Lateral File [Accessories section](#) for full accessory details.

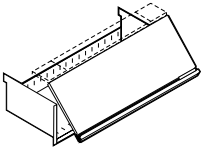
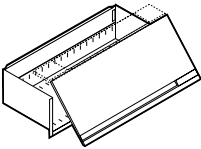
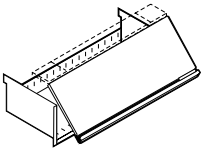
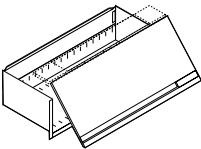
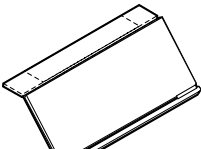
Description	Part number	Exterior Height	Width	Weight (lbs)	9900 series/ Neutral paint	Accent paint																	
 15" lift-up door with pullout shelf	15LUE/PS-30	15"	30"	21	\$293	+\$32																	
	15LUE/PS-36	15"	42"	29	\$337	+\$35																	
	15LUE/PS-42	15"	42"	29	\$374	+\$39																	
	<table border="1"> <thead> <tr> <th>Optional Accessories</th> <th>Part #</th> <th>Price</th> </tr> </thead> <tbody> <tr> <td>Hangfile Bars (30", 36" & 42")</td> <td>HF-xx</td> <td>+\$45</td> </tr> <tr> <td>Sliding Rails *note: two rails are required per drawer</td> <td>SR</td> <td>+\$16</td> </tr> <tr> <td>Plate Divider</td> <td>DVP</td> <td>+\$21</td> </tr> <tr> <td>Legal to Letter Adapter (30", 36" & 42")</td> <td>LL-xx</td> <td>+\$25</td> </tr> <tr> <td>EDP Kit (30", 36" & 42")</td> <td>EDPxx</td> <td>+\$81</td> </tr> </tbody> </table>						Optional Accessories	Part #	Price	Hangfile Bars (30", 36" & 42")	HF-xx	+\$45	Sliding Rails *note: two rails are required per drawer	SR	+\$16	Plate Divider	DVP	+\$21	Legal to Letter Adapter (30", 36" & 42")	LL-xx	+\$25	EDP Kit (30", 36" & 42")	EDPxx
Optional Accessories	Part #	Price																					
Hangfile Bars (30", 36" & 42")	HF-xx	+\$45																					
Sliding Rails *note: two rails are required per drawer	SR	+\$16																					
Plate Divider	DVP	+\$21																					
Legal to Letter Adapter (30", 36" & 42")	LL-xx	+\$25																					
EDP Kit (30", 36" & 42")	EDPxx	+\$81																					
 15" lift-up door with pullout shelf with raised back	15LUE/PS-30RB	15"	30"	21	\$317	+\$33																	
	15LUE/PS-36RB	15"	36"	25	\$358	+\$37																	
	15LUE/PS-42RB	15"	42"	29	\$399	+\$44																	
	<table border="1"> <thead> <tr> <th>Optional Accessories</th> <th>Part #</th> <th>Price</th> </tr> </thead> <tbody> <tr> <td>Plate Divider</td> <td>DVP</td> <td>+\$21</td> </tr> <tr> <td>Legal to Letter Adapter (30", 36" & 42")</td> <td>LL-xx</td> <td>+\$25</td> </tr> </tbody> </table>						Optional Accessories	Part #	Price	Plate Divider	DVP	+\$21	Legal to Letter Adapter (30", 36" & 42")	LL-xx	+\$25								
Optional Accessories	Part #	Price																					
Plate Divider	DVP	+\$21																					
Legal to Letter Adapter (30", 36" & 42")	LL-xx	+\$25																					
 15" lift-up door with fixed shelf	15LUE/FS-30	15"	30"	20	\$254	+\$27																	
	15LUE/FS-36	15"	36"	23	\$295	+\$32																	
	15LUE/FS-42	15"	42"	27	\$344	+\$36																	
	<table border="1"> <thead> <tr> <th>Optional Accessories</th> <th>Part #</th> <th>Price</th> </tr> </thead> <tbody> <tr> <td>Plate Divider</td> <td>DVP</td> <td>+\$21</td> </tr> <tr> <td>Legal to Letter Adapter (30", 36" & 42")</td> <td>LL-xx</td> <td>+\$25</td> </tr> </tbody> </table>						Optional Accessories	Part #	Price	Plate Divider	DVP	+\$21	Legal to Letter Adapter (30", 36" & 42")	LL-xx	+\$25								
Optional Accessories	Part #	Price																					
Plate Divider	DVP	+\$21																					
Legal to Letter Adapter (30", 36" & 42")	LL-xx	+\$25																					
 15" lift-up door with fixed shelf with raised back	15LUE/FS-30RB	15"	30"	20	\$277	+\$30																	
	15LUE/FS-36RB	15"	36"	23	\$320	+\$34																	
	15LUE/FS-42RB	15"	42"	27	\$368	+\$39																	
	<table border="1"> <thead> <tr> <th>Optional Accessories</th> <th>Part #</th> <th>Price</th> </tr> </thead> <tbody> <tr> <td>Plate Divider</td> <td>DVP</td> <td>+\$21</td> </tr> <tr> <td>Legal to Letter Adapter (30", 36" & 42")</td> <td>LL-xx</td> <td>+\$25</td> </tr> </tbody> </table>						Optional Accessories	Part #	Price	Plate Divider	DVP	+\$21	Legal to Letter Adapter (30", 36" & 42")	LL-xx	+\$25								
Optional Accessories	Part #	Price																					
Plate Divider	DVP	+\$21																					
Legal to Letter Adapter (30", 36" & 42")	LL-xx	+\$25																					
 15" lift-up door	15LUE-30	15"	30"	12	\$162	+\$19																	
	15LUE-36	15"	36"	15	\$198	+\$22																	
	15LUE-42	15"	42"	19	\$220	+\$24																	

How to order

- Specify basic cabinet product number followed by drawer and shelf interiors with their accessories (see [Accessories section](#)) in order from TOP to BOTTOM, indicating which interior is in the top position. Interiors may be specified in almost any combination to make up the TOTAL INTERIOR HEIGHT.
- Specify finish color

Product code key example

15LUE/PL-36

- 15** module height
LU lift-up
E 9900 Series
PL laminate pullout shelf
36 width

Finishes

Refer to [Finishes section](#) for color options. Drawer bodies and accessories are finished in Eco Black.

Optional Accessories

Accessories are optional for all items on this page. Available accessories are outlined with each set of product codes.

Note: Sliding Rails must be used in conjunction with Hangfile Bars, EDP Kits or X-ray Kits.

Visit the Lateral File [Accessories section](#) for full accessory details.

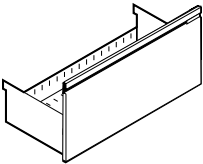
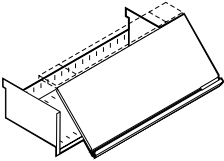
Description	Part number	Exterior Height	Width	Weight (lbs)	9900 series/ Neutral paint	Accent paint
 15" lift-up door with laminate pullout shelf	15LUE/PL-30	15"	30"	36	\$555	+\$58
	15LUE/PL-36	15"	36"	45	\$610	+\$63
	15LUE/PL-42	15"	42"	54	\$667	+\$69
 15" lift-up door with 2 pullout shelves, 9" and 6"	15LUE/96PS-30	15"	30"	23	\$466	+\$49
	15LUE/96PS-36	15"	36"	28	\$505	+\$53
	15LUE/96PS-42	15"	42"	33	\$555	+\$58
			Optional Accessories	Part #	Price	
			Plate Divider	DVP	+ \$21	
 16.5" Opening Interiors 16.5" fixed front drawer	16.5FFE-30	16.5"	30"	17	\$345	+\$36
	16.5FFE-36	16.5"	36"	20	\$377	+\$42
	16.5FFE-42	16.5"	42"	24	\$437	+\$47
			Optional Accessories	Part #	Price	
			Hangfile Bars (30", 36" & 42")	HF-xx	+ \$45	
			Sliding Rails *note: two rails are required per drawer	SR	+ \$16	
			Plate Divider	DVP	+ \$21	
			Legal to Letter Adapter (30", 36" & 42")	LL-xx	+ \$25	
			EDP Kit (30", 36" & 42")	EDPxx	+ \$81	
			X-ray Kit (30", 36" & 42")	XRAY/EDPxx	+ \$90	
 16.5" fixed front drawer with raised back	16.5FFE-30RB	16.5"	30"	17	\$367	+\$39
	16.5FFE-36RB	16.5"	36"	20	\$401	+\$44
	16.5FFE-42RB	16.5"	42"	24	\$463	+\$49
			Optional Accessories	Part #	Price	
			Plate Divider	DVP	+ \$21	
			Legal to Letter Adapter (30", 36" & 42")	LL-xx	+ \$25	
			X-ray Kit (30", 36" & 42")	XRAY/EDPxx	+ \$90	
 16.5" lift-up door with pullout shelf	16.5LUE/PS-30	16.5"	30"	22	\$345	+\$36
	16.5LUE/PS-36	16.5"	36"	26	\$377	+\$42
	16.5LUE/PS-42	16.5"	42"	30	\$437	+\$47
			Optional Accessories	Part #	Price	
			Hangfile Bars (30", 36" & 42")	HF-xx	+ \$45	
			Sliding Rails *note: two rails are required per drawer	SR	+ \$16	
			Plate Divider	DVP	+ \$21	
			Legal to Letter Adapter (30", 36" & 42")	LL-xx	+ \$25	
			EDP Kit (30", 36" & 42")	EDPxx	+ \$81	
			X-ray Kit (30", 36" & 42")	XRAY/EDPxx	+ \$90	

How to order

1. Specify basic cabinet product number followed by drawer and shelf interiors with their accessories (see [Accessories section](#)) in order from TOP to BOTTOM, indicating which interior is in the top position. Interiors may be specified in almost any combination to make up the TOTAL INTERIOR HEIGHT.
2. Specify finish color

Product code key example

16.5LUE/PS-36RB

16.5 module height
LU lift-up
E 9900 Series
PS pullout shelf
36 width
RB raised back

Finishes

Refer to [Finishes section](#) for color options. Drawer bodies and accessories are finished in Eco Black.

Optional Accessories

Accessories are optional for all items on this page. Available accessories are outlined with each set of product codes.

Visit the Lateral File [Accessories section](#) for full accessory details.

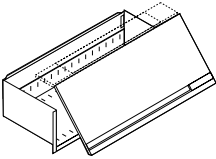
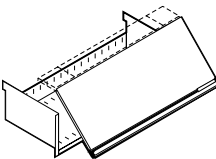
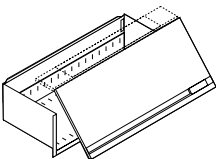
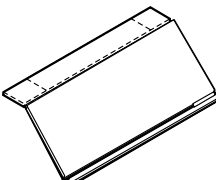
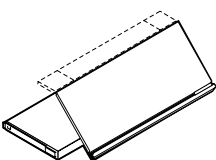
Description	Part number	Exterior Height	Width	Weight (lbs)	9900 series/ Neutral paint	Accent point
 16.5" lift-up door with pullout shelf with raised back	16.5LUE/PS-30RB	16.5"	30"	22	\$367	+\$39
	16.5LUE/PS-36RB	16.5"	36"	26	\$401	+\$44
	16.5LUE/PS-42RB	16.5"	42"	30	\$463	+\$49
	Optional Accessories					
	Plate Divider	DVP				+\$21
	Legal to Letter Adapter (30", 36" & 42")	LL-xx				+\$25
	X-ray Kit (30", 36" & 42")	XRAY/EDPxx				+\$90
 16.5" lift-up door with fixed shelf	16.5LUE/FS-30	16.5"	30"	21	\$312	+\$33
	16.5LUE/FS-36	16.5"	36"	24	\$339	+\$35
	16.5LUE/FS-42	16.5"	42"	28	\$391	+\$43
	Optional Accessories					
	Plate Divider	DVP				+\$21
	Legal to Letter Adapter (30", 36" & 42")	LL-xx				+\$25
 16.5" lift-up door with fixed shelf with raised back	16.5LUE/FS-30RB	16.5"	30"	21	\$333	+\$35
	16.5LUE/FS-36RB	16.5"	36"	24	\$360	+\$37
	16.5LUE/FS-42RB	16.5"	42"	28	\$416	+\$45
	Optional Accessories					
	Plate Divider	DVP				+\$21
	Legal to Letter Adapter (30", 36" & 42")	LL-xx				+\$25
 16.5" lift-up door	16.5LUE-30	16.5"	30"	13	\$228	+\$25
	16.5LUE-36	16.5"	36"	16	\$256	+\$27
	16.5LUE-42	16.5"	42"	20	\$314	+\$33
	Optional Accessories					
 16.5" lift-up door with laminate pullout shelf	16.5LUE/PL-30	16.5"	30"	37	\$625	+\$64
	16.5LUE/PL-36	16.5"	36"	46	\$698	+\$71
	16.5LUE/PL-42	16.5"	42"	55	\$786	+\$83
	Optional Accessories					

How to order

1. Specify basic cabinet product number followed by drawer and shelf interiors with their accessories (see [Accessories section](#)) in order from TOP to BOTTOM, indicating which interior is in the top position. Interiors may be specified in almost any combination to make up the TOTAL INTERIOR HEIGHT.
2. Specify finish color

Product code key example

24HDE/SH-36

24 module height
HD hinged door
E 9900 Series
SH shelf
36 width

A hinged door insert includes a bottom shelf. This means that the insert door height and usable interior space is actually 1 1/2" less than the heights noted in the descriptions.

Lock option

Hinged door inserts come standard with lock. If lock is not required add suffix **'/NL'** after product number. Deduct \$57 list.

Finishes

Refer to [Finishes section](#) for color options. Drawer bodies and accessories are finished in Eco Black.

Optional Accessories

Accessories are optional for all items on this page. Available accessories are outlined with each set of product codes.

Visit the Lateral File [Accessories section](#) for full accessory details.

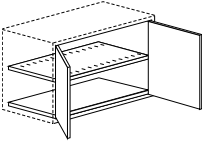
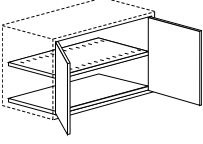
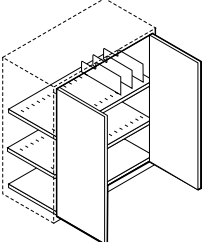
Description	Part number	Exterior Height	Width	Weight (lbs)	9900 series/ Neutral paint	Accent point
 <p>24" hinged door cupboard insert with 1 adjustable slotted shelf. Shelf dividers are not included. Bottom shelf is standard with slots. Must be specified in the top opening.</p>	24HDE/SH-30	24"	30"	36	\$589	+\$61
	24HDE/SH-36	24"	36"	50	\$629	+\$64
	24HDE/SH-42	24"	42"	64	\$724	+\$74
	Optional Accessories		Part #		Price	
	Plate Divider *note: three plates are required per insert	DVP				+\$21
 <p>27" hinged door cupboard insert with 1 adjustable slotted shelf. Shelf dividers are not included. Bottom shelf is standard with slots. Must be specified in the top opening.</p>	27HDE/SH-30	27"	30"	38	\$589	+\$61
	27HDE/SH-36	27"	36"	52	\$629	+\$64
	27HDE/SH-42	27"	42"	62	\$724	+\$74
	Optional Accessories		Part #		Price	
	Plate Divider *note: three plates are required per insert	DVP				+\$21
 <p>39" hinged door cupboard insert with 2 adjustable slotted shelves. Shelf dividers are not included. Will accommodate 3 rows of standard binders. Bottom shelf is standard with slots. Must be specified in the top opening.</p>	39HDE/SH-30	39"	30"	52	\$655	+\$67
	39HDE/SH-36	39"	36"	78	\$695	+\$71
	39HDE/SH-42	39"	42"	93	\$786	+\$83
	Optional Accessories		Part #		Price	
	Plate Divider *note: three plates are required per insert	DVP				+\$21

How to order

1. Specify basic cabinet product number followed by drawer and shelf interiors with their accessories (see [Accessories section](#)) in order from TOP to BOTTOM, indicating which interior is in the top position. Interiors may be specified in almost any combination to make up the TOTAL INTERIOR HEIGHT.
2. Specify finish color

Product code key example 24SS-36

24 module height
SS SuperStor™ insert
36 width

A hinged door insert includes a bottom shelf. This means that the insert door height and usable interior space is actually 1 ½" less than the heights noted in the descriptions.

SuperStor™ inserts are designed exclusively to fit inside 36" wide cabinets. SuperStor™ inserts are built with a horizontal support at the base of the unit which functions as a tie bar. Depending on the components specified for the cabinet interior an additional tie bar need not be specified if the specified components fill the cabinet interior. SuperStor™ tray fronts angle downwards ½" to permit labeling. **SuperStor™ trays are sold separately.**

Lock option

SuperStor™ inserts with hinged doors come standard with lock. If lock is not required add suffix **'/NL'** after product number. Deduct \$57 list.

Note: Locks cannot be field installed on hinged door cabinets.

Finishes

Refer to [Finishes section](#) for color options. Drawer bodies and accessories are finished in Eco Black.

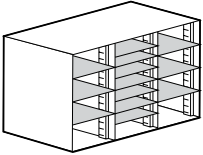
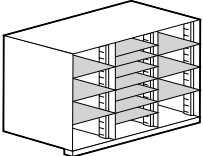
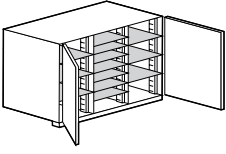
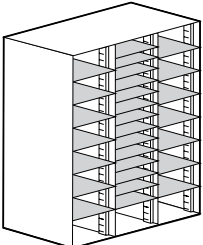
Description	Part number	Exterior Height	Width	Weight (lbs)	9900 series/ Neutral paint	Accent paint
 <p>This SuperStor™ insert is designed exclusively to fit inside a cabinet with an interior height of 24". Insert contains 3 vertical compartments each with 22 slots at 1" increments. Order trays separately.</p>	24SS-36	24"	36"	55	\$542	+\$57
 <p>25.5" Opening Interior 25.5" SuperStor™ insert, contains 3 vertical compartments each with 22 slots at 1" increments. May be installed in cabinets with 36" or more interior. SuperStor™ insert must be specified in the top opening of your build-up. Order trays separately.</p>	25.5SS-36	25.5"	36"	55	\$542	+\$57
 <p>25.5" Opening Interior 25.5" SuperStor™ insert with or without hinged doors, contains 3 vertical compartments each with 22 slots at 1" increments. May be installed in cabinets with 36" or more interior. SuperStor™ insert must be specified in the top opening of your build-up. Order trays separately.</p>	25.5SSHDE-36	25.5"	36"	80	\$914	+\$94
 <p>This SuperStor™ insert is designed exclusively to fit inside a cabinet with an interior height of 49.5". Insert contains 3 vertical compartments each with 48 slots at 1" increments. Order trays separately.</p>	49.5SS-36	49.5"	36"	110	\$885	+\$91

How to order

1. Specify basic cabinet product number followed by drawer and shelf interiors with their accessories (see [Accessories section](#)) in order from TOP to BOTTOM, indicating which interior is in the top position. Interiors may be specified in almost any combination to make up the TOTAL INTERIOR HEIGHT.
2. Specify finish color

Product code key example 51SS-36

- 51** module height
SS SuperStor™ insert
36 width

SuperStor™ inserts are designed exclusively to fit inside 36" wide cabinets. SuperStor™ inserts are built with a horizontal support at the base of the unit which functions as a tie bar. Depending on the components specified for the cabinet interior an additional tie bar need not be specified if the specified components fill the cabinet interior. SuperStor™ tray fronts angle downwards ½" to permit labeling. **SuperStor™ trays are sold separately.**

A hinged door insert includes a bottom shelf. This means that the insert door height and usable interior space is actually 1 ½" less than the heights noted in the descriptions.

Lock option

SuperStor™ inserts with hinged doors come standard with lock. If lock is not required add suffix '/NL' after product number. Deduct \$57 list.

Note: Locks cannot be field installed on hinged door cabinets.

Finishes

Refer to [Finishes section](#) for color options. Drawer bodies and accessories are finished in Eco Black. SuperStore and trays are Onyx only.

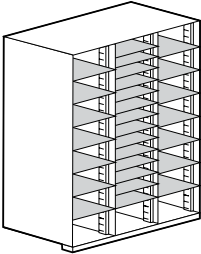
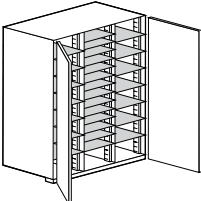
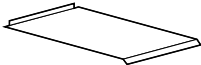
Description	Part number	Exterior Height	Width	Weight (lbs)	9900 series/ Neutral paint	Accent paint
 <p>51" Opening Interior 51" SuperStor™ insert with or without hinged doors, contains 3 vertical compartments each with 48" slots at 1" increments. May be installed in cabinets with 58.5" or more interior. SuperStor™ inserts must be specified in the top opening of your build-up. Order trays separately.</p>	51SS-36	51"	36"	110	\$857	+\$89
 <p>51" Opening Interior 51" SuperStor™ insert with or without hinged doors, contains 3 vertical compartments each with 48" slots at 1" increments. May be installed in cabinets with 58.5" or more interior. SuperStor™ inserts must be specified in the top opening of your build-up. Order trays separately.</p>	51SSHDE-36	51"	36"	195	\$1493	+\$152
 <p>SuperStor™ trays Pack of 12 trays, black only</p>	T12SS-BL	—	10"	25	\$268	—

How to order

1. Specify basic cabinet product number followed by drawer and shelf interiors with their accessories (see [Accessories section](#)) in order from TOP to BOTTOM, indicating which interior is in the top position. Interiors may be specified in almost any combination to make up the TOTAL INTERIOR HEIGHT.
2. Specify finish color

Product code key example BK-13.530

BK bookcase insert
13.5 height
30 width

Bookcase inserts include a bottom shelf. This means that the insert door height and usable interior space is actually 1½” less than the heights noted in the descriptions.

All bookcase inserts have the option to select fixed or adjustable shelves. The shelves are included in the code and will be factory installed.





If the **fixed shelf option** is selected, shelf mounting holes will not be visible in the bookcase insert inner side panels and the fixed shelves & bottom shelf will not include divider plate slots.

If the **adjustable shelf option** is selected, the full range of shelf mounting holes on 1.5” centers will be visible in the bookcase insert inner side panels. The adjustable shelves & bottom shelf will include divider plate slots. Please note the 13.5” Adjustable shelf option, we will offer no shelves, they will need to be ordered separately.

Drawers and shelf interiors on these pages do not include accessories. See Lateral File [Accessories section](#) for accessories.

Finishes

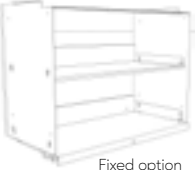
Refer to [Finishes section](#) for color options.

	Description	Part number	Height	Width	Weight (lbs)	Neutral paint/ base price	Accent paint
 <p>Fixed option</p>	BK-13.530	BK-13.530	13.5”	30”	—	\$303	+\$31
		BK-13.536	13.5”	36”	—	\$314	+\$32
		BK-13.542	13.5”	42”	—	\$324	+\$33
 <p>Adjustable option</p>							
 <p>Fixed option</p>	BK-25.530	BK-25.530	25.5”	30”	—	\$324	+\$33
		BK-25.536	25.5”	36”	—	\$335	+\$34
		BK-25.542	25.5”	42”	—	\$346	+\$35
 <p>Adjustable option</p>							

How to order

1. Specify basic cabinet product number followed by drawer and shelf interiors with their accessories (see [Accessories section](#)) in order from TOP to BOTTOM, indicating which interior is in the top position. Interiors may be specified in almost any combination to make up the TOTAL INTERIOR HEIGHT.
2. Specify finish color

Product code key example

BK-13.530

BK bookcase insert
13.5 height
30 width

Bookcase inserts include a bottom shelf. This means that the insert door height and usable interior space is actually 1½" less than the heights noted in the descriptions.

All bookcase inserts have the option to select fixed or adjustable shelves. The shelves are included in the code and will be factory installed.





If the **fixed shelf option** is selected, shelf mounting holes will not be visible in the bookcase insert inner side panels and the fixed shelves & bottom shelf will not include divider plate slots.

If the **adjustable shelf option** is selected, the full range of shelf mounting holes on 1.5" centers will be visible in the bookcase insert inner side panels. The adjustable shelves & bottom shelf will include divider plate slots. Please note the 13.5" Adjustable shelf option, we will offer no shelves, they will need to be ordered separately.

Drawers and shelf interiors on these pages do not include accessories. See Lateral File [Accessories section](#) for accessories.

Finishes

Refer to [Finishes section](#) for color options.

	Description	Part number	Height	Width	Weight (lbs)	Neutral paint/ base price	Accent paint
 Fixed option	BK-13.530	BK-3930	39"	30"	—	\$389	+\$39
		BK-3936	39"	36"	—	\$400	+\$40
		BK-3942	39"	42"	—	\$411	+\$42
 Adjustable option							
 Fixed option	BK-13.530	BK-52.530	52.5"	30"	—	\$486	+\$49
		BK-52.536	52.5"	36"	—	\$497	+\$50
		BK-52.542	52.5"	42"	—	\$508	+\$51
 Adjustable option							



Towers

US Price List • June 2021

Our Modular Towers can be outfitted to hold anything—coats, shoes, tech, you name it. Choose from open storage, closed storage or both, find the right fit for you. All of the Office Specialty Modular Towers have a chamfered (beveled) corner detail. This biophilic design element offers a clean look to each corner of the tower.

ANSI/BIFMA

With the addition of counterweights where appropriate, Modular Towers meet all ANSI/BIFMA specifications.

Construction

Modular Towers and hinged door cabinets are constructed using 20 and 22 gauge high quality, tension leveled, cold rolled steel. The steel gauges selected for drawer fronts, bodies and accessories ensure the highest quality durability and performance for all components.

Construction features & benefits

1. All interiors are modular and interchangeable so that cabinets can be retrofitted with new accessories and interiors as required.
2. Case corners are strengthened with a reinforcing zinc die cast corner bracket.
3. Absence of scissor mechanism in doors and drawers eliminates the potential for scissors binding and facilitates reconfiguration of cabinet openings as needed.
4. Box drawer sides are slotted on 1" centers to allow for maximum flexibility for drawer division.
5. Box drawer side double-wall construction provides clean appearance and enclosed divider slots.
6. File drawer bodies have full-height sides to accommodate hanging file folders, eliminating the need for optional file frames.
7. Front leading edge of shelf is flat for easy removal of material.
8. Fully-progressive ball bearing suspensions are staged so that left and right sides work in unison. This provides smooth drawer operation with minimum force.
9. Special "claw-like" device incorporated in suspensions "grips" the fixed section of the suspension arm preventing drawer bounce-back or creep when drawer is closed.
10. Self-closing, 110° opening, European style cupboard hinges provide smooth hinged door operation. Hinges are not visible from the exterior of the cabinet.

Drawer pulls

9900 Series fronts have full width integral pulls with enamel finish to match case fronts.

Safelock™

The patented Safelock™ mechanism provides complete security against accidental opening of two or more drawers simultaneously. When any drawer or single pullout shelf is extended, even fractionally, Safelock™ ensures that all other openings immediately become inoperable. Safelock™ is standard on all towers.

Counterweights

See [Counterweight matrix](#).

Glides

Overall heights are inclusive of metal glides. Heights may be increased up to 3/8" by extending standard glide. Glides are accessible from inside the cabinet when the bottom drawer is fully extended or removed and may be adjusted with a 1/4" socket driver.

Optional 1/2" stem glides are available. Specify separately and add \$30 list to the cabinet price. Requires field installation.

Locks

Modular Towers come standard with lock. If lock is not required add suffix '/NL' after product number. Deduct \$57 list per lock. For lock location, see guide at the beginning of this price list.

Random keying is standard. Files may be ordered keyed alike. Specify. Locks feature removable core and are standard with two keys, one of which has a black neoprene plastic key cover.

Master keys are available at \$51 list. For lock finish options, refer to the front of this price list.

Finishes

Refer to [Finishes section](#) for color options.

How to order

1. Specify product number.
2. Specify finish color.
3. Specify options.

Product code key example MR2424E-P2F10

M	Modular Series
R	right-handed door
24	tower width
24	interior height
E	9900 Series
P	pencil drawer
2	number of drawers
F10	10 1/2" file drawer

Exterior cabinet heights are actual heights with glides fully recessed. Units containing pencil and/or box drawers include one pencil tray per unit. Each box drawer contains one steel divider. 10 1/2" and 12" drawers have one sliding rail for side-to-side filing of letter size folders or printout binders. Hinged doors are standard with self closing European style hinges and open 110°.

Lock option

Modular towers come standard with lock. If lock is not required add suffix '/NL' after product number. Deduct \$57 list per lock.

Counterweights

Counterweights are required for ALL freestanding units that are not anchored or ganged to other cabinets or bolted to walls/floor. See [Counterweight matrix](#).

Accessories

Refer to [Accessories section](#) for options.

Finishes

Refer to [Finishes section](#) for color options. Interior drawer bodies and shelves are finished in Eco Black. Bookshelves in side access towers are the same finish as the case.

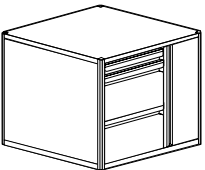
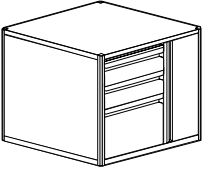
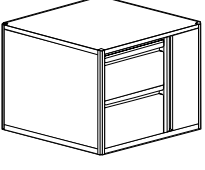
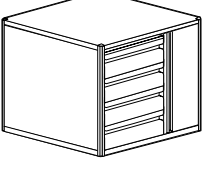
	Description	Part number	Exterior Height	Width	Depth	Weight (lbs)	Neutral paint/ base price	Accent paint
	Full-length hinged door on one side, 1-3" pencil and 2-10.5" file drawers on the other side. Comes with 2 locks and counterweights.	ML2424E-P2F10	27 1/4"	24"	24"	102	\$1791	+\$181
		ML3024E-P2F10	27 1/4"	30"	24"	118	\$1898	+\$192
		MR2424E-P2F10	27 1/4"	24"	24"	102	\$1791	+\$181
		MR3024E-P2F10	27 1/4"	30"	24"	118	\$1898	+\$192
		left-handed hinged door						
		right-handed hinged door (illustrated)						
	Full-length hinged door on one side 2-6" box and 1-12" file drawer on the other side. Comes with 2 locks and counterweights.	ML2424E-2BF	27 1/4"	24"	24"	102	\$1791	+\$181
		ML3024E-2BF	27 1/4"	30"	24"	118	\$1898	+\$192
		MR2424E-2BF	27 1/4"	24"	24"	102	\$1791	+\$181
		MR3024E-2BF	27 1/4"	30"	24"	118	\$1898	+\$192
		left-handed hinged door						
		right-handed hinged door (illustrated)						
	Full-length hinged door on one side, 2-12" file drawers on the other side. Comes with 2 locks and counterweights.	ML2424E-2F	27 1/4"	24"	24"	102	\$1728	+\$175
		ML3024E-2F	27 1/4"	30"	24"	118	\$1833	+\$185
		MR2424E-2F	27 1/4"	24"	24"	102	\$1728	+\$175
		MR3024E-2F	27 1/4"	30"	24"	118	\$1833	+\$185
		left-handed hinged door						
		right-handed hinged door (illustrated)						
	Full-length hinged door on one side, 4-6" box drawers on the other side. Comes with 2 locks and counterweights.	ML2424E-4B	27 1/4"	24"	24"	102	\$2136	+\$215
		ML3024E-4B	27 1/4"	30"	24"	118	\$2212	+\$223
		MR2424E-4B	27 1/4"	24"	24"	102	\$2136	+\$215
		MR3024E-4B	27 1/4"	30"	24"	118	\$2212	+\$223
		left-handed hinged door						
		right-handed hinged door (illustrated)						

How to order

1. Specify product number.
2. Specify finish color.
3. Specify options.

Product code key example MR3024E-P2F10

M	Modular Series
R	right-handed door
24	tower width
24	interior height
E	9900 Series
D	double pedestal
P	pencil drawer
2	number of drawers
F10	10 1/2" file drawer

Exterior cabinet heights are actual heights with glides fully recessed. Units containing pencil and/or box drawers include one pencil tray per unit. Each box drawer contains one steel divider. 10 1/2" and 12" drawers have one sliding rail for side-to-side filing of letter size folders or printout binders. Hinged doors are standard with self closing European style hinges and open 110°.

Lock option

Modular towers come standard with lock. If lock is not required add suffix '/NL' after product number. Deduct \$57 list per lock.

Counterweights

Counterweights are required for ALL freestanding units that are not anchored or ganged to other cabinets or bolted to walls/floor. See [Counterweight matrix](#).

Accessories

Refer to [Accessories section](#) for options.

Finishes

Refer to [Finishes section](#) for color options. Interior drawer bodies and shelves are finished in Eco Black. Bookshelves in side access towers are the same finish as the case.

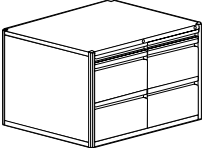
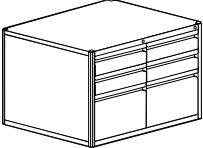
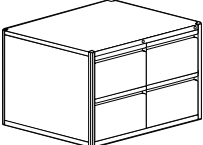
	Description	Part number	Exterior Height	Width	Depth	Weight (lbs)	Neutral paint/ base price	Accent paint
	1-3" pencil and 2-10.5" file drawers on both sides. Comes with 2 locks and counterweights.	M3024E-DP2F10	27 1/4"	30"	24"	180	\$2950	+\$296
	2-6" box and 1-12" file drawer on both sides. Comes with 2 locks and counterweights.	M3024E-D2BF	27 1/4"	30"	24"	180	\$2950	+\$296
	2-12" file drawers on both sides. Comes with 2 locks and counterweights.	M3024E-D2F	27 1/4"	30"	24"	180	\$2859	+\$288

How to order

1. Specify product number.
2. Specify finish color.
3. Specify options.

Product code key example MRM2424E-P2F10

M	Modular Series
R	right-handed door
M	MoPed
24	tower width
24	interior height
E	9900 Series
P	pencil drawer
2	number of drawers
F10	10 1/2" file drawer

Exterior cabinet heights are actual heights with glides fully recessed. Units containing pencil and/or box drawers include one pencil tray per unit. Each box drawer contains one steel divider. 10 1/2" and 12" drawers have one sliding rail for side-to-side filing of letter size folders or printout binders. Hinged doors are standard with self closing European style hinges and open 110°.

Lock option

Modular towers come standard with lock. If lock is not required add suffix '/NL' after product number. Deduct \$57 list per lock.

Counterweights

Counterweights are required for ALL freestanding units that are not anchored or ganged to other cabinets or bolted to walls/floor. See [Counterweight matrix](#).

Accessories

Refer to [Accessories section](#) for options.

Finishes

Refer to [Finishes section](#) for color options. Interior drawer bodies and shelves are finished in Eco Black. Interior of MoPed is aluminum painted.

	Description	Part number	Exterior Height	Width	Depth	Weight (lbs)	Neutral paint/base price	Accent paint
	MoPed on one side, 1-3" pencil and 2-10.5" file drawers on the other side. Comes with 2 locks and 1 counterweight. Accessories are not included in MoPed.	MLM2424EP2F10 left-handed 5" sliding drawer	27 1/4"	24"	24"	116	\$2279	+\$229
		MRM2424EP2F10 right-handed 5" sliding drawer (illustrated)	27 1/4"	24"	24"	116	\$2279	+\$229
	MoPed on one side, 2-6" box and 1-12" file drawer on the other side. Comes with 2 locks and 1 counterweight. Accessories are not included in MoPed.	MLM2424E-2BF left-handed 5" sliding drawer	27 1/4"	24"	24"	116	\$2279	+\$229
		MRM2424E-2BF right-handed 5" sliding drawer (illustrated)	27 1/4"	24"	24"	116	\$2279	+\$229
	MoPed on one side, 2-12" file drawers on the other side. Comes with 2 locks and 1 counterweight. Accessories are not included in MoPed.	MLM2424E-2F left-handed 5" sliding drawer	27 1/4"	24"	24"	116	\$2081	+\$210
		MRM2424E-2F right-handed 5" sliding drawer (illustrated)	27 1/4"	24"	24"	116	\$2081	+\$210
	MoPed on one side, 4-6" box drawers on the other side. Comes with 2 locks and 1 counterweight. Accessories are not included in MoPed.	MLM2424E-4B left-handed 5" sliding drawer	27 1/4"	24"	24"	116	\$2491	+\$251
		MRM2424E-4B right-handed 5" sliding drawer (illustrated)	27 1/4"	24"	24"	116	\$2491	+\$251

How to order

1. Specify product number.
2. Specify finish color.
3. Specify options.

Product code key example M2419.5E-HD

M Modular Series
24 tower width
19.5 interior height
E 9900 Series
HD hinged door

Exterior cabinet heights are actual heights with glides fully recessed. Units containing pencil and/or box drawers include one pencil tray per unit. Each box drawer contains one steel divider. 10½" and 12" drawers have one sliding rail for side-to-side filing of letter size folders or printout binders. Hinged doors are standard with self closing European style hinges and open 110°.

Lock option

Modular towers come standard with lock. If lock is not required add suffix '/NL' after product number. Deduct \$57 list per lock.

Counterweights

Counterweights are required for ALL freestanding units that are not anchored or ganged to other cabinets or bolted to walls/floor. See [Counterweight matrix](#).

Accessories

Refer to [Accessories section](#) for options.

Finishes

Refer to [Finishes section](#) for color options. Interior drawer bodies and shelves are finished in Eco Black. Bookshelves in side access towers are the same finish as the case.

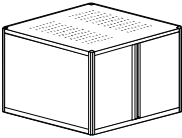
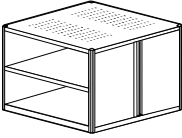
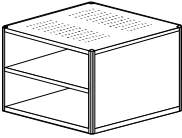
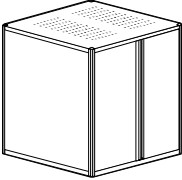
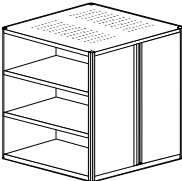
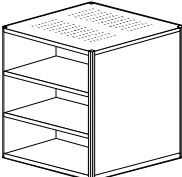
	Description	Part number	Exterior Height	Width	Depth	Weight (lbs)	Neutral paint/ base price	Accent paint
	Two full-length hinged doors with 1 shelf per side. Comes with 2 locks	M2419.5E-HD	22 ¾"	24"	24"	75	\$1154	+\$118
		M3019.5E-HD	22 ¾"	30"	24"	91	\$1286	+\$131
	Full-length hinged door on one side (30" wide comes with 1 shelf), 19.5" side access bookcase with 1 shelf on the other side. Comes with 1 lock.	ML2419.5E-HDK	22 ¾"	24"	24"	75	\$1028	+\$105
		ML3019.5E-HDK left-handed hinged door	22 ¾"	30"	24"	91	\$1259	+\$129
		MR2419.5E-HDK	22 ¾"	24"	24"	75	\$1028	+\$105
		MR3019.5E-HDK right-handed hinged door (illustrated)	22 ¾"	30"	24"	91	\$1259	+\$129
	Two 19.5" side access bookcases with 1 shelf per side.	M2419.5-2K	22 ¾"	24"	24"	75	\$1133	+\$116
		M3019.5-2K	22 ¾"	30"	24"	91	\$1196	+\$123
	Two full-length hinged doors with 2 shelves per side. Comes with 2 locks.	M2433E-HD	36 ¼"	24"	24"	92	\$1489	+\$151
		M3033E-HD	36 ¼"	30"	24"	114	\$1599	+\$164
	Full-length hinged door with coat rod on one side, 33" side access bookcase with 2 shelves on the other side. Comes with 1 lock.	ML2433E-HDK	36 ¼"	24"	24"	92	\$1329	+\$135
		ML3033E-HDK left-handed hinged door	36 ¼"	30"	24"	114	\$1554	+\$159
		MR2433E-HDK	36 ¼"	24"	24"	92	\$1329	+\$135
		MR3033E-HDK right-handed hinged door (illustrated)	36 ¼"	30"	24"	114	\$1554	+\$159
	Two 33" high side access bookcases with 2 shelves per side.	M2433-2K	36 ¼"	24"	24"	92	\$1385	+\$140
		M3033-2K	36 ¼"	30"	24"	114	\$1502	+\$152

How to order

1. Specify product number.
2. Specify finish color.
3. Specify options.

Product code key example MR1658E-BB7FK

M	Modular Series
R	right-handed door
16	tower width
58	interior height
E	9900 Series
B	6" box drawer
B7	7 1/2" box drawer
F	12" file drawer
K	bookcase

Exterior cabinet heights are actual heights with glides fully recessed. Units containing pencil and/or box drawers include one pencil tray per unit. Each box drawer contains one steel divider. 10 1/2" and 12" drawers have one sliding rail for side-to-side filing of letter size folders or printout binders. Hinged doors are standard with self closing European style hinges and open 110°.

Lock option

Modular towers come standard with lock. If lock is not required add suffix '/NL' after product number. Deduct \$57 list per lock.

Counterweights

Counterweights are required for ALL freestanding units that are not anchored or ganged to other cabinets or bolted to walls/floor. See [Counterweight matrix](#).

Accessories

Refer to [Accessories section](#) for options.

Finishes

Refer to [Finishes section](#) for color options. Interior drawer bodies and shelves are finished in Eco Black. Bookshelves in side access towers are the same finish as the case.

Description	Part number	Exterior Height	Width	Depth	Weight (lbs)	Neutral paint/ base price	Accent paint
 <p>31.5" bookcase with pedestal consisting of 1-6" box drawer, 1-7.5" box drawer and 1-12" file drawer. Comes with 1 lock.</p>	ML1658E-BB7FK left hand	61 3/4"	16"	24"	130	\$2893	+\$291
	MR1658E-BB7FK right hand (illustrated)	61 3/4"	16"	24"	130	\$2893	+\$291
 <p>31.5" bookcase with pedestal consisting of 1-3" pencil drawer 1-10.5" file drawer and 1-12" file drawer. Comes with 1 lock.</p>	ML1658E-PF10FK left hand	61 3/4"	16"	24"	130	\$2893	+\$291
	MR1658E-PF10FK right hand (illustrated)	61 3/4"	16"	24"	130	\$2893	+\$291
 <p>15" bookcase on each side with pedestal consisting of 2-12" individually locking file drawers. Comes with 2 locks.</p>	M1658E-2FTBKS	61 3/4"	16"	24"	130	\$3166	+\$320

How to order

1. Specify product number.
2. Specify finish color.
3. Specify options.

Product code key example MR2443E-P2F

M Modular Series
R right-handed door
24 tower width
43 interior height
E 9900 Series
P pencil drawer
2 number of drawers
F 12" file drawer

Exterior cabinet heights are actual heights with glides fully recessed. Units containing pencil and/or box drawers include one pencil tray per unit. Each box drawer contains one steel divider. 10½" and 12" drawers have one sliding rail for side-to-side filing of letter size folders or printout binders. Hinged doors are standard with self closing European style hinges and open 110°.

Lock option

Modular towers come standard with lock. If lock is not required add suffix '/NL' after product number. Deduct \$57 list per lock.

Counterweights

Counterweights are required for ALL freestanding units that are not anchored or ganged to other cabinets or bolted to walls/floor. See [Counterweight matrix](#).

Accessories

Refer to [Accessories section](#) for options.

Finishes

Refer to [Finishes section](#) for color options. Interior drawer bodies and shelves are finished in Eco Black. Bookshelves in side access towers are the same finish as the case.

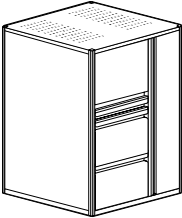
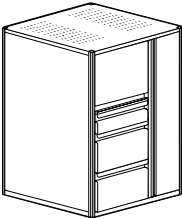
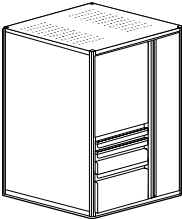
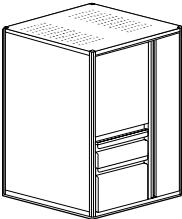
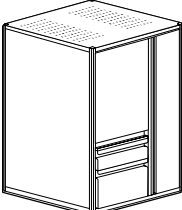
Description	Part number	Exterior Height	Width	Depth	Weight (lbs)	Neutral paint/ base price	Accent paint
 <p>Full-length door with coat rod on one side, 16.5" high hinged door insert, 1-3" pencil and 2-12" file drawers on the other side. Comes with 3 locks.</p>	ML2443E-P2F	46 ¾"	24"	24"	145	\$3247	+\$328
	ML3043E-P2F left-handed hinged door	46 ¾"	30"	24"	162	\$3411	+\$344
	MR2443E-P2F	46 ¾"	24"	24"	145	\$3247	+\$328
	MR3043E-P2F right-handed hinged door (illustrated)	46 ¾"	30"	24"	162	\$3411	+\$344
 <p>Full-length door with coat rod on one side, 16.5" high hinged door insert, 1-6" box and 2-10.5" file drawers on the other side. Comes with 3 locks.</p>	ML2443E-B2F10	46 ¾"	24"	24"	145	\$3247	+\$328
	ML3043E-B2F10 left-handed hinged door	46 ¾"	30"	24"	162	\$3411	+\$344
	MR2443E-B2F10	46 ¾"	24"	24"	145	\$3247	+\$328
	MR3043E-B2F10 right-handed hinged door (illustrated)	46 ¾"	30"	24"	162	\$3411	+\$344
 <p>Full-length door with coat rod on one side, 24" high hinged door insert with 1 shelf, 1-3" pencil, 1-6" box and 1-10.5" file drawer on the other side. Comes with 3 locks.</p>	ML2443E-PBF10	46 ¾"	24"	24"	145	\$3247	+\$328
	ML3043E-PBF10 left-handed hinged door	46 ¾"	30"	24"	162	\$3411	+\$344
	MR2443E-PBF10	46 ¾"	24"	24"	145	\$3247	+\$328
	MR3043E-PBF10 right-handed hinged door (illustrated)	46 ¾"	30"	24"	162	\$3411	+\$344
 <p>Full-length door with coat rod on one side, 24" high hinged door insert with 1 shelf, 1-7.5" box and 1-12" - file drawer on the other side. Comes with 3 locks.</p>	ML2443E-B7F	46 ¾"	24"	24"	145	\$3105	+\$314
	ML3043E-B7F left-handed hinged door	46 ¾"	30"	24"	162	\$3272	+\$330
	MR2443E-B7F	46 ¾"	24"	24"	145	\$3105	+\$314
	MR3043E-B7F right-handed hinged door (illustrated)	46 ¾"	30"	24"	162	\$3272	+\$330
 <p>Full-length door with coat rod on one side, 27" high hinged door insert with 1 shelf, 1-6" box and 1-10.5" file drawer on the other side. Comes with 3 locks.</p>	ML2443E-BF10	46 ¾"	24"	24"	145	\$3105	+\$314
	ML3043E-BF10 left-handed hinged door	46 ¾"	30"	24"	162	\$3272	+\$330
	MR2443E-BF10	46 ¾"	24"	24"	145	\$3105	+\$314
	MR3043E-BF10 right-handed hinged door (illustrated)	46 ¾"	30"	24"	162	\$3272	+\$330

How to order

1. Specify product number.
2. Specify finish color.
3. Specify options.

Product code key example MR2443E-PF10FK

M	Modular Series
R	right-handed door
24	tower width
43	interior height
E	9900 Series
P	pencil drawer
F10	10 ½" file drawer
F	12" file drawer
K	bookcase

Exterior cabinet heights are actual heights with glides fully recessed. Units containing pencil and/or box drawers include one pencil tray per unit. Each box drawer contains one steel divider. 10½" and 12" drawers have one sliding rail for side-to-side filing of letter size folders or printout binders. Hinged doors are standard with self closing European style hinges and open 110°.

Lock option

Modular towers come standard with lock. If lock is not required add suffix '/NL' after product number. Deduct \$57 list per lock.

Counterweights

Counterweights are required for ALL freestanding units that are not anchored or ganged to other cabinets or bolted to walls/floor. See [Counterweight matrix](#).

Accessories

Refer to [Accessories section](#) for options.

Finishes

Refer to [Finishes section](#) for color options. Interior drawer bodies and shelves are finished in Eco Black. Bookshelves in side access towers are the same finish as the case.

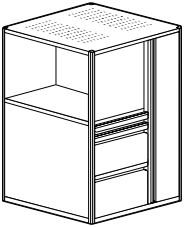
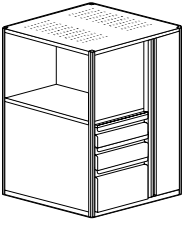
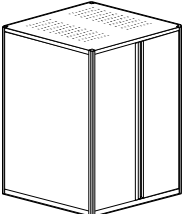
Description	Part number	Exterior Height	Width	Depth	Weight (lbs)	Neutral point/ base price	Accent point
 <p>Full-length door with coat rod on one side, 1-16.5" high side access bookcase, 1-3" pencil, 1-10.5" and 1-12" file drawer on the other side. Comes with 2 locks.</p>	ML2443EPF10FK	46 ¾"	24"	24"	150	\$2909	+\$292
	ML3043EPF10FK	46 ¾"	30"	24"	167	\$3056	+\$308
	MR2443EPF10FK	46 ¾"	24"	24"	150	\$2909	+\$292
	MR3043EPF10FK	46 ¾"	30"	24"	167	\$3056	+\$308
 <p>Full-length door with coat rod on one side, 16.5" high side access bookcase, 1-6" box, 1-7.5" box and 1-12" file drawer on the other side. Comes with 2 locks.</p>	ML2443E-BB7FK	46 ¾"	24"	24"	150	\$2908	+\$292
	ML3043E-BB7FK	46 ¾"	30"	24"	167	\$3055	+\$308
	MR2443E-BB7FK	46 ¾"	24"	24"	150	\$2908	+\$292
	MR3043E-BB7FK	46 ¾"	30"	24"	167	\$3055	+\$308
 <p>Two full-length hinged doors, coat rod on one side and shelves on the other side. Comes with 2 locks.</p>	ML2443E-HD	46 ¾"	24"	24"	118	\$2311	+\$234
	ML3043E-HD	46 ¾"	30"	24"	135	\$2467	+\$249
	MR2443E-HD	46 ¾"	24"	24"	118	\$2311	+\$234
	MR3043E-HD	46 ¾"	30"	24"	135	\$2467	+\$249

How to order

1. Specify product number.
2. Specify finish color.
3. Specify options.

Product code key example MR2445E-2F10

M	Modular Series
R	right-handed door
24	tower width
45	interior height
E	9900 Series
2	number of drawers
F10	10 ½" file drawer

Exterior cabinet heights are actual heights with glides fully recessed. Units containing pencil and/or box drawers include one pencil tray per unit. Each box drawer contains one steel divider. 10½" and 12" drawers have one sliding rail for side-to-side filing of letter size folders or printout binders. Hinged doors are standard with self closing European style hinges and open 110°.

A hinged door insert includes a bottom shelf. This means that the insert door height and usable interior space is actually 1 ½" less than the heights noted in the descriptions.

Lock option

Modular towers come standard with lock. If lock is not required add suffix '**/NL**' after product number. Deduct \$57 list per lock.

Counterweights

Counterweights are required for ALL freestanding units that are not anchored or ganged to other cabinets or bolted to walls/floor.



See [Counterweight matrix](#).

Accessories

Refer to [Accessories section](#) for options.

Finishes

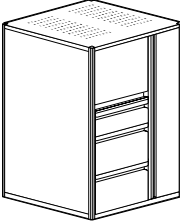
Refer to [Finishes section](#) for color options. Interior drawer bodies and shelves are finished in Eco Black. Bookshelves in side access towers are the same finish as the case.

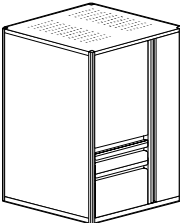
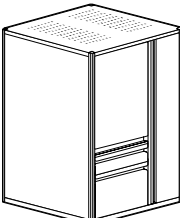
Description	Part number	Exterior Height	Width	Depth	Weight (lbs)	Neutral paint/base price	Accent paint
 <p>Full-length door with coat rod on one side, 16.5" high hinged door insert, 1-7.5" box and 2-10.5" file drawer on the other side. Comes with 3 locks.</p>	ML2445EB72F10	48 ¼"	24"	24"	145	\$3247	+\$328
	ML3045EB72F10 left-handed hinged door	48 ¼"	30"	24"	162	\$3411	+\$344
	MR2445EB72F10	48 ¼"	24"	24"	145	\$3247	+\$328
	MR3045EB72F10 right-handed hinged door (illustrated)	48 ¼"	30"	24"	162	\$3411	+\$344
 <p>Full-length door with coat rod on one side, 24" hinged door insert with 1 shelf, 2-10.5" file drawers on the other side. Comes with 3 locks.</p>	ML2445E-2F10	48 ¼"	24"	24"	145	\$3105	+\$314
	ML3045E-2F10 left-handed hinged door	48 ¼"	30"	24"	162	\$3272	+\$330
	MR2445E-2F10	48 ¼"	24"	24"	145	\$3105	+\$314
	MR3045E-2F10 right-handed hinged door (illustrated)	48 ¼"	30"	24"	162	\$3272	+\$330
 <p>Full-length door with coat rod on one side, 27" high hinged door insert with 1 shelf, 1-7.5" box and 1-10.5" file drawer on other side. Comes with 3 locks.</p>	ML2445E-B7F10	48 ¼"	24"	24"	145	\$3105	+\$314
	ML3045E-B7F10 left-handed hinged door	48 ¼"	30"	24"	162	\$3272	+\$330
	MR2445E-B7F10	48 ¼"	24"	24"	145	\$3105	+\$314
	MR3045E-B7F10 right-handed hinged door (illustrated)	48 ¼"	30"	24"	162	\$3272	+\$330
 <p>Full-length door with coat rod on one side, 27" high hinged door insert with 1 shelf, 1-6" box and 1-12" file drawer on the other side. Comes with 3 locks.</p>	ML2445E-BF	48 ¼"	24"	24"	145	\$3105	+\$314
	ML3045E-BF left-handed hinged door	48 ¼"	30"	24"	162	\$3272	+\$330
	MR2445E-BF	48 ¼"	24"	24"	145	\$3105	+\$314
	MR3045E-BF right-handed hinged door (illustrated)	48 ¼"	30"	24"	162	\$3272	+\$330

How to order

1. Specify product number.
2. Specify finish color.
3. Specify options.

Product code key example MR2445E-PF10FK

M	Modular Series
R	right-handed door
24	tower width
45	interior height
E	9900 Series
P	pencil drawer
F10	10 ½" file drawer
F	12" file drawer
K	bookcase

Exterior cabinet heights are actual heights with glides fully recessed. Units containing pencil and/or box drawers include one pencil tray per unit. Each box drawer contains one steel divider. 10½" and 12" drawers have one sliding rail for side-to-side filing of letter size folders or printout binders. Hinged doors are standard with self closing European style hinges and open 110°.

Lock option

Modular towers come standard with lock. If lock is not required add suffix '/NL' after product number. Deduct \$57 list per lock.

Counterweights

Counterweights are required for ALL freestanding units that are not anchored or ganged to other cabinets or bolted to walls/floor. See [Counterweight matrix](#).

Accessories

Refer to [Accessories section](#) for options.

Finishes

Refer to [Finishes section](#) for color options. Interior drawer bodies and shelves are finished in Eco Black. Bookshelves in side access towers are the same finish as the case.

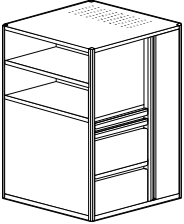
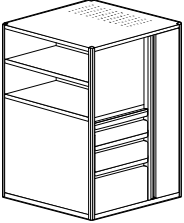
Description	Part number	Exterior Height	Width	Depth	Weight (lbs)	Neutral paint/ base price	Accent paint
 <p>Full-length door with coat rod on one side, 18" high side access bookcase with 1 shelf, 1-3" pencil, 1-10.5" and 1-12" file drawers on the other side. Comes with 2 locks.</p>	ML2445EPF10FK	48 ¼"	24"	24"	150	\$2821	+\$285
	ML3045EPF10FK	48 ¼"	30"	24"	167	\$2970	+\$300
	MR2445EPF10FK	48 ¼"	24"	24"	150	\$2821	+\$285
	MR3045EPF10FK	48 ¼"	30"	24"	167	\$2970	+\$300
 <p>Full-length door with coat rod on one side, 18" high side access bookcase with 1 shelf, 1-6" box, 1-7.5" box and 1-12" file drawer on the other side. Comes with 2 locks.</p>	ML2445E-BB7FK	48 ¼"	24"	24"	150	\$2821	+\$285
	ML3045E-BB7FK	48 ¼"	30"	24"	167	\$2970	+\$300
	MR2445E-BB7FK	48 ¼"	24"	24"	150	\$2821	+\$285
	MR3045E-BB7FK	48 ¼"	30"	24"	167	\$2970	+\$300
 <p>Two full-length hinged doors with coat rod on one side and shelves on the other side. Comes with 2 locks.</p>	ML2445E-HD	48 ¼"	24"	24"	118	\$2311	+\$234
	ML3045E-HD	48 ¼"	30"	24"	135	\$2466	+\$249
	MR2445E-HD	48 ¼"	24"	24"	118	\$2311	+\$234
	MR3045E-HD	48 ¼"	30"	24"	135	\$2466	+\$249

How to order

1. Specify product number.
2. Specify finish color.
3. Specify options.

Product code key example MR2446E-F10F

M	Modular Series
R	right-handed door
24	tower width
46	interior height
E	9900 Series
F10	10 1/2" file drawer
F	12" file drawer

Exterior cabinet heights are actual heights with glides fully recessed. Units containing pencil and/or box drawers include one pencil tray per unit. Each box drawer contains one steel divider. 10 1/2" and 12" drawers have one sliding rail for side-to-side filing of letter size folders or printout binders. Hinged doors are standard with self closing European style hinges and open 110°.

A hinged door insert includes a bottom shelf. This means that the insert door height and usable interior space is actually 1 1/2" less than the heights noted in the descriptions.

Lock option

Modular towers come standard with lock. If lock is not required add suffix '**/NL**' after product number. Deduct \$57 list per lock.

Counterweights

Counterweights are required for ALL freestanding units that are not anchored or ganged to other cabinets or bolted to walls/floor. See [Counterweight matrix](#).

Accessories

Refer to [Accessories section](#) for options.

Finishes

Refer to [Finishes section](#) for color options. Interior drawer bodies and shelves are finished in Eco Black. Bookshelves in side access towers are the same finish as the case.

Description	Part number	Exterior Height	Width	Depth	Weight (lbs)	Neutral paint/base price	Accent paint
 <p>Full-length door with coat rod on one side, 16.5" high hinged door insert, 1-6" box and 2-12" file drawers on other side. Comes with 3 locks.</p>	ML2446E-B2F	49 3/4"	24"	24"	145	\$3247	+\$328
	ML3046E-B2F left-handed hinged door	49 3/4"	30"	24"	162	\$3411	+\$344
	MR2446E-B2F	49 3/4"	24"	24"	145	\$3247	+\$328
	MR3046E-B2F right-handed hinged door (illustrated)	49 3/4"	30"	24"	162	\$3411	+\$344
 <p>Full-length door with coat rod on one side, 24" high hinged door insert with 1 shelf, 2-6" box and 1-10.5" file drawers on other side. Comes with 3 locks.</p>	ML2446E-2BF10	49 3/4"	24"	24"	145	\$3343	+\$337
	ML3046E-2BF10 left-handed hinged door	49 3/4"	30"	24"	162	\$3506	+\$354
	MR2446E-2BF10	49 3/4"	24"	24"	145	\$3343	+\$337
	MR3046E-2BF10 right-handed hinged door (illustrated)	49 3/4"	30"	24"	162	\$3506	+\$354
 <p>Full-length door with coat rod on one side, 24" high hinged door insert with 1 shelf, 1-10.5" and 1-12" file drawer on other side. Comes with 3 locks.</p>	ML2446E-F10F	49 3/4"	24"	24"	145	\$3105	+\$314
	ML3046E-F10F left-handed hinged door	49 3/4"	30"	24"	162	\$3272	+\$330
	MR2446E-F10F	49 3/4"	24"	24"	145	\$3105	+\$314
	MR3046E-F10F right-handed hinged door (illustrated)	49 3/4"	30"	24"	162	\$3272	+\$330
 <p>Full-length door with coat rod on one side, 27" high hinged door insert with 1 shelf, 1-7.5" box and 1-12" file drawer on other side. Comes with 3 locks.</p>	ML2446E-B7F	49 3/4"	24"	24"	145	\$3105	+\$314
	ML3046E-B7F left-handed hinged door	49 3/4"	30"	24"	162	\$3272	+\$330
	MR2446E-B7F	49 3/4"	24"	24"	145	\$3105	+\$314
	MR3046E-B7F right-handed hinged door (illustrated)	49 3/4"	30"	24"	162	\$3272	+\$330

How to order

1. Specify product number.
2. Specify finish color.
3. Specify options.

Product code key example

MR2445E-PF10FK

M	Modular Series
R	right-handed door
24	tower width
46	interior height
E	9900 Series
P	pencil drawer
F10	10 ½" file drawer
F	12" file drawer
K	bookcase

Exterior cabinet heights are actual heights with glides fully recessed. Units containing pencil and/or box drawers include one pencil tray per unit. Each box drawer contains one steel divider. 10½" and 12" drawers have one sliding rail for side-to-side filing of letter size folders or printout binders. Hinged doors are standard with self closing European style hinges and open 110°.

Lock option

Modular towers come standard with lock. If lock is not required add suffix **'/NL'** after product number. Deduct \$57 list per lock.

Counterweights

Counterweights are required for ALL freestanding units that are not anchored or ganged to other cabinets or bolted to walls/floor.

See [Counterweight matrix](#).

Accessories

Refer to [Accessories section](#) for options.

Finishes

Refer to [Finishes section](#) for color options. Interior drawer bodies and shelves are finished in Eco Black. Bookshelves in side access towers are the same finish as the case.

Description	Part number	Exterior Height	Width	Depth	Weight (lbs)	Neutral paint/ base price	Accent paint
 <p>Full-length door with coat rod on one side, 19.5" high side access bookcase with 1 shelf, 1-3" pencil, 1-10.5" and 1-12" file drawer on the other side. Comes with 2 locks.</p>	ML2446EPF10FK	49 ¾"	24"	24"	150	\$2821	+\$285
	ML3046EPF10FK	49 ¾"	30"	24"	167	\$2970	+\$300
	MR2446EPF10FK	49 ¾"	24"	24"	150	\$2821	+\$285
	MR3046EPF10FK	49 ¾"	30"	24"	167	\$2970	+\$300
 <p>Full-length door with coat rod on one side, 19.5" high side access bookcase with 1 shelf, 1-6" box, 1-7.5" box and 1-12" file drawer on the other side. Comes with 2 locks.</p>	ML2446E-BB7FK	49 ¾"	24"	24"	150	\$2821	+\$285
	ML3046E-BB7FK	49 ¾"	30"	24"	167	\$2970	+\$300
	MR2446E-BB7FK	49 ¾"	24"	24"	150	\$2821	+\$285
	MR3046E-BB7FK	49 ¾"	30"	24"	167	\$2970	+\$300
 <p>Two full-length hinged doors. Coat rod on one side and shelves on the other. Comes with 2 locks.</p>	MR2446E-HD	49 ¾"	24"	24"	118	\$2311	+\$234
	MR3046E-HD	49 ¾"	30"	24"	135	\$2459	+\$249
	ML2446E-HD	49 ¾"	24"	24"	118	\$2311	+\$234
	ML3046E-HD	49 ¾"	30"	24"	135	\$2459	+\$249

How to order

1. Specify product number.
2. Specify finish color.
3. Specify options.

Product code key example MR2458E-B3F

M	Modular Series
R	right-handed door
24	tower width
58	interior height
E	9900 Series
B	6" box drawer
3	number of drawers
F	12" file drawer

Exterior cabinet heights are actual heights with glides fully recessed. Units containing pencil and/or box drawers include one pencil tray per unit. Each box drawer contains one steel divider. 10½" and 12" drawers have one sliding rail for side-to-side filing of letter size folders or printout binders. Hinged doors are standard with self closing European style hinges and open 110°.

A hinged door insert includes a bottom shelf. This means that the insert door height and usable interior space is actually 1 ½" less than the heights noted in the descriptions.

Accessories

Refer to [Accessories section](#) for options.

Lock option

Modular towers come standard with lock. If lock is not required add suffix **'/NL'** after product number. Deduct \$57 list per lock.

Counterweights

Counterweights are required for ALL freestanding units that are not anchored or ganged to other cabinets or bolted to walls/floor.

See [Counterweight matrix](#).

Finishes

Refer to [Finishes section](#) for color options. Interior drawer bodies and shelves are finished in Eco Black. Bookshelves in side access towers are the same finish as the case.

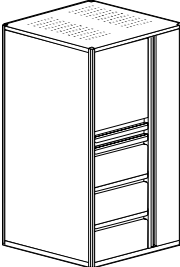
Description	Part number	Exterior Height	Width	Depth	Weight (lbs)	Neutral paint/ base price	Accent paint
 <p>Full-length door with coat rod on one side, 16.5" high hinged door insert, 1-6" box and 3-12" file drawers on other side. Comes with 3 locks.</p>	ML2458E-B3F	61 ¾"	24"	24"	180	\$3522	+\$355
	ML3058E-B3F	61 ¾"	30"	24"	198	\$4062	+\$410
	left-handed hinged door						
	MR2458E-B3F	61 ¾"	24"	24"	180	\$3522	+\$355
 <p>Full length door with coat rod on one side, 16.5" high hinged door insert and 4-10.5" file drawers on other side. Comes with 3 locks.</p>	ML2458E-4F10	61 ¾"	24"	24"	180	\$3522	+\$355
	ML3058E-4F10	61 ¾"	30"	24"	198	\$4062	+\$410
	left-handed hinged door						
	MR2458E-4F10	61 ¾"	24"	24"	180	\$3522	+\$355
 <p>Full-length door with coat rod on one side, 24" high hinged door insert with 1 shelf, 1-3" pencil and 3-10.5" file drawers on other side. Comes with 3 locks.</p>	ML2458E-P3F10	61 ¾"	24"	24"	180	\$3556	+\$358
	ML3058E-P3F10	61 ¾"	30"	24"	198	\$4095	+\$412
	left-handed hinged door						
	MR2458E-P3F10	61 ¾"	24"	24"	180	\$3556	+\$358
 <p>Full-length door with coat rod on one side, 24" high hinged door insert with 1 shelf, 1-3" pencil, 1-7.5" box and 2-12" file drawers on other side. Comes with 3 locks.</p>	ML2458E-PB72F	61 ¾"	24"	24"	180	\$3556	+\$358
	ML3058E-PB72F	61 ¾"	30"	24"	198	\$4095	+\$412
	left-handed hinged door						
	MR2458E-PB72F	61 ¾"	24"	24"	180	\$3556	+\$358
	MR3058E-PB72F	61 ¾"	30"	24"	198	\$4095	+\$412
	right-handed hinged door (illustrated)						

How to order

1. Specify product number.
2. Specify finish color.
3. Specify options.

Product code key example MR2458E-3F10

M	Modular Series
R	right-handed door
24	tower width
58	interior height
E	9900 Series
3	number of drawers
F10	10 1/2" file drawer

Exterior cabinet heights are actual heights with glides fully recessed. Units containing pencil and/or box drawers include one pencil tray per unit. Each box drawer contains one steel divider. 10 1/2" and 12" drawers have one sliding rail for side-to-side filing of letter size folders or printout binders. Hinged doors are standard with self closing European style hinges and open 110°.

A hinged door insert includes a bottom shelf. This means that the insert door height and usable interior space is actually 1 1/2" less than the heights noted in the descriptions.

Accessories

Refer to [Accessories section](#) for options.

Lock option

Modular towers come standard with lock. If lock is not required add suffix **'/NL'** after product number. Deduct \$57 list per lock.

Counterweights

Counterweights are required for ALL freestanding units that are not anchored or ganged to other cabinets or bolted to walls/floor. See [Counterweight matrix](#).

Finishes

Refer to [Finishes section](#) for color options. Interior drawer bodies and shelves are finished in Eco Black. Bookshelves in side access towers are the same finish as the case.

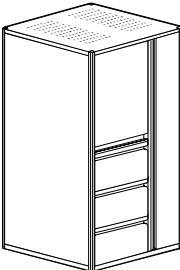
Description	Part number	Exterior Height	Width	Depth	Weight (lbs)	Neutral paint/ base price	Accent paint
 <p>Full-length door with coat rod on one side, 27" high hinged door insert with 1 shelf and 3-10.5" file drawers on other side. Comes with 3 locks.</p>	ML2458E-3F10	61 3/4"	24"	24"	180	\$3476	+\$350
	ML3058E-3F10 left-handed hinged door	61 3/4"	30"	24"	198	\$4005	+\$403
	MR2458E-3F10	61 3/4"	24"	24"	180	\$3476	+\$350
	MR3058E-3F10 right-handed hinged door (illustrated)	61 3/4"	30"	24"	198	\$4005	+\$403
 <p>Full-length door with coat rod on one side, 25.5" high hinged door insert with 1 shelf, 1-7.5" box and 2-12" file drawers on other side. Comes with 3 locks.</p>	ML2458E-B72F	61 3/4"	24"	24"	180	\$3476	+\$350
	ML3058E-B72F left-handed hinged door	61 3/4"	30"	24"	198	\$4005	+\$403
	MR2458E-B72F	61 3/4"	24"	24"	180	\$3476	+\$350
	MR3058E-B72F right-handed hinged door (illustrated)	61 3/4"	30"	24"	198	\$4005	+\$403
 <p>Full-length door with coat rod on one side, 31.5" high side access bookcase with 2 shelves, 1-3" pencil, 1-10.5" and 1-12" file drawers on the other side. Comes with 2 locks.</p>	ML2458EPF10FK	61 3/4"	24"	24"	180	\$2953	+\$296
	ML3058EPF10FK left-handed hinged door	61 3/4"	30"	24"	198	\$3089	+\$312
	MR2458EPF10FK	61 3/4"	24"	24"	180	\$2953	+\$296
	MR3058EPF10FK right-handed hinged door (illustrated)	61 3/4"	30"	24"	198	\$3089	+\$312
 <p>Full length door with coat rod on one side, 31.5" high side access bookcase with 2 shelves, 1-6" box, 1-7.5" box and 1-12" file drawer on the other side. Comes with 2 locks.</p>	ML2458E-BB7FK	61 3/4"	24"	24"	180	\$2953	+\$296
	ML3058E-BB7FK left-handed hinged door	61 3/4"	30"	24"	198	\$3089	+\$312
	MR2458E-BB7FK	61 3/4"	24"	24"	180	\$2953	+\$296
	MR3058E-BB7FK right-handed hinged door (illustrated)	61 3/4"	30"	24"	198	\$3089	+\$312

How to order

1. Specify product number.
2. Specify finish color.
3. Specify options.

Product code key example MR2460E-2B2F

M	Modular Series
R	right-handed door
24	tower width
60	interior height
E	9900 Series
2	number of drawers
B	6" box drawer
2	number of drawers
F	12" file drawer

Exterior cabinet heights are actual heights with glides fully recessed. Units containing pencil and/or box drawers include one pencil tray per unit. Each box drawer contains one steel divider. 10½" and 12" drawers have one sliding rail for side-to-side filing of letter size folders or printout binders. Hinged doors are standard with self closing European style hinges and open 110°.

A hinged door insert includes a bottom shelf. This means that the insert door height and usable interior space is actually 1 ½" less than the heights noted in the descriptions.

Accessories

Refer to [Accessories section](#) for options.

Lock option

Modular towers come standard with lock. If lock is not required add suffix **'/NL'** after product number. Deduct \$57 list per lock.

Counterweights

Counterweights are required for ALL freestanding units that are not anchored or ganged to other cabinets or bolted to walls/floor. See [Counterweight matrix](#).

Finishes

Refer to [Finishes section](#) for color options. Interior drawer bodies and shelves are finished in Eco Black. Bookshelves in side access towers are the same finish as the case.

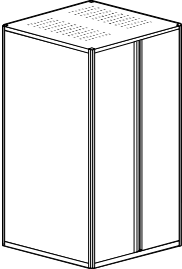
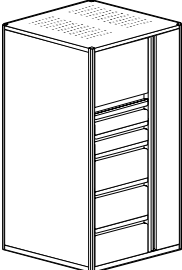
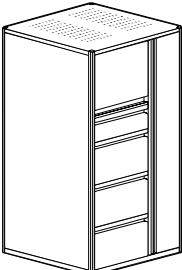
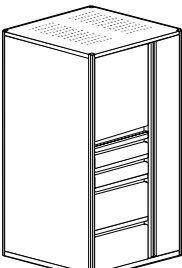
Description	Part number	Exterior Height	Width	Depth	Weight (lbs)	Neutral paint/ base price	Accent paint
 <p>Two full-length hinged doors. Coat rod on one side and shelves on the other side. Comes with 2 locks.</p>	ML2458E-HD	61 ¾"	24"	24"	140	\$2370	+\$240
	ML3058E-HD coat rod on left side	61 ¾"	30"	24"	168	\$2544	+\$256
	MR2458E-HD	61 ¾"	24"	24"	140	\$2370	+\$240
	MR3058E-HD coat rod on right side	61 ¾"	30"	24"	168	\$2544	+\$256
 <p>Full-length door with coat rod on one side, 16.5" high hinged door insert, 2-6" box and 3-10.5" file drawers on other side. Comes with 3 locks.</p>	ML2460E-2B3F10	63 ¼"	24"	24"	180	\$3756	+\$377
	ML3060E-2B3F10 left-handed hinged door	63 ¼"	30"	24"	198	\$4312	+\$434
	MR2460E-2B3F10	63 ¼"	24"	24"	180	\$3756	+\$377
	MR3060E-2B3F10 right-handed hinged door (illustrated)	63 ¼"	30"	24"	198	\$4312	+\$434
 <p>Full-length door with coat rod on one side, 15" high hinged door insert, 1-7.5" box and 3-12" file drawers on other side. Comes with 3 locks.</p>	ML2460E-B73F	63 ¼"	24"	24"	180	\$3522	+\$355
	ML3060E-B73F left-handed hinged door	63 ¼"	30"	24"	198	\$4062	+\$410
	MR2460E-B73F	63 ¼"	24"	24"	180	\$3522	+\$355
	MR3060E-B73F right-handed hinged door (illustrated)	63 ¼"	30"	24"	198	\$4062	+\$410
 <p>Full-length door with coat rod on one side, 24" high hinged door insert with 1 shelf, 2-6" box and 2-12" file drawers on other side. Comes with 3 locks.</p>	ML2460E-2B2F	63 ¼"	24"	24"	180	\$3556	+\$358
	ML3060E-2B2F left-handed hinged door	63 ¼"	30"	24"	198	\$4095	+\$412
	MR2460E-2B2F	63 ¼"	24"	24"	180	\$3556	+\$358
	MR3060E-2B2F right-handed hinged door (illustrated)	63 ¼"	30"	24"	198	\$4095	+\$412

How to order

1. Specify product number.
2. Specify finish color.
3. Specify options.

Product code key example MR2460E-3F

M	Modular Series
R	right-handed door
24	tower width
60	interior height
E	9900 Series
3	number of drawers
F	12" file drawer

Exterior cabinet heights are actual heights with glides fully recessed. Units containing pencil and/or box drawers include one pencil tray per unit. Each box drawer contains one steel divider. 10½" and 12" drawers have one sliding rail for side-to-side filing of letter size folders or printout binders. Hinged doors are standard with self closing European style hinges and open 110°.

A hinged door insert includes a bottom shelf. This means that the insert door height and usable interior space is actually 1 ½" less than the heights noted in the descriptions.

Accessories

Refer to [Accessories section](#) for options.

Lock option

Modular towers come standard with lock. If lock is not required add suffix **'/NL'** after product number. Deduct \$57 list per lock.

Counterweights

Counterweights are required for ALL freestanding units that are not anchored or ganged to other cabinets or bolted to walls/floor. See [Counterweight matrix](#).

Finishes

Refer to [Finishes section](#) for color options. Interior drawer bodies and shelves are finished in Eco Black. Bookshelves in side access towers are the same finish as the case.

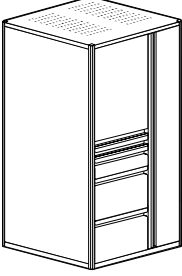
Description	Part number	Exterior Height	Width	Depth	Weight (lbs)	Neutral paint/ base price	Accent paint
 <p>Full-length door with coat rod on one side, 24" high hinged door insert with 1 shelf and 3-12" file drawers on other side. Comes with 3 locks.</p>	ML2460E-3F	63 ¼"	24"	24"	180	\$3476	+\$350
	ML3060E-3F left-handed hinged door	63 ¼"	30"	24"	198	\$4005	+\$403
	MR2460E-3F	63 ¼"	24"	24"	180	\$3476	+\$350
	MR3060E-3F right-handed hinged door (illustrated)	63 ¼"	30"	24"	198	\$4005	+\$403
 <p>Full-length door with coat rod on one side, 27" high hinged door insert with 1 shelf, 1-3" pencil, 1-6" box and 2-12" file drawers on other side. Comes with 3 locks.</p>	ML2460E-PB2F	63 ¼"	24"	24"	180	\$3556	+\$358
	ML3060E-PB2F left-handed hinged door	63 ¼"	30"	24"	198	\$4095	+\$412
	MR2460E-PB2F	63 ¼"	24"	24"	180	\$3556	+\$358
	MR3060E-PB2F right-handed hinged door (illustrated)	63 ¼"	30"	24"	198	\$4095	+\$412
 <p>Full-length door with coat rod on one side, 27" high hinged door insert with 1 shelf, 2-6" box and 2-10.5" file drawers on other side. Comes with 3 locks.</p>	ML2460E2B2F10	63 ¼"	24"	24"	180	\$3556	+\$358
	ML3060E2B2F10 left-handed hinged door	63 ¼"	30"	24"	198	\$4095	+\$412
	MR2460E2B2F10	63 ¼"	24"	24"	180	\$3556	+\$358
	MR3060E2B2F10 right-handed hinged door (illustrated)	63 ¼"	30"	24"	198	\$4095	+\$412
 <p>Full-length door with coat rod on one side, 25.5" high hinged door insert with 1 shelf, 2-10.5" and 1-12" file drawer on other side. Comes with 3 locks.</p>	ML2460E-2F10F	63 ¼"	24"	24"	180	\$3476	+\$350
	ML3060E-2F10F left-handed hinged door	63 ¼"	30"	24"	198	\$4005	+\$403
	MR2460E-2F10F	63 ¼"	24"	24"	180	\$3476	+\$350
	MR3060E-2F10F right-handed hinged door (illustrated)	63 ¼"	30"	24"	198	\$4005	+\$403

How to order

1. Specify product number.
2. Specify finish color.
3. Specify options.

Product code key example

MR2460E-P10FK

M	Modular Series
R	right-handed door
24	tower width
60	interior height
E	9900 Series
P	pencil drawer
F10	10 ½" file drawer
F	12" file drawer
K	bookcase

Exterior cabinet heights are actual heights with glides fully recessed. Units containing pencil and/or box drawers include one pencil tray per unit. Each box drawer contains one steel divider. 10½" and 12" drawers have one sliding rail for side-to-side filing of letter size folders or printout binders. Hinged doors are standard with self closing European style hinges and open 110°.

Lock option

Modular towers come standard with lock. If lock is not required add suffix **'/NL'** after product number. Deduct \$57 list per lock.

Counterweights

Counterweights are required for ALL freestanding units that are not anchored or ganged to other cabinets or bolted to walls/floor. See [Counterweight matrix](#).

Accessories

Refer to [Accessories section](#) for options.

Finishes

Refer to [Finishes section](#) for color options. Interior drawer bodies and shelves are finished in Eco Black. Bookshelves in side access towers are the same finish as the case.

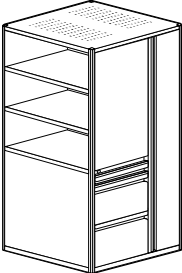
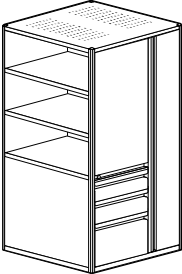
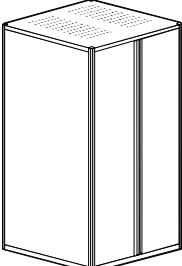
Description	Part number	Exterior Height	Width	Depth	Weight (lbs)	Neutral paint/ base price	Accent paint
 <p>Full-length door with coat rod on one side, 33" high side access bookcase with 2 shelves, 1-3" pencil, 1-10.5" and 1-12" file drawer on the other side. Comes with 2 shelves. Comes with 2 locks.</p>	ML2460EPF10FK	63 ¼"	24"	24"	180	\$2954	+\$296
	ML3060EPF10FK	63 ¼"	30"	24"	198	\$3093	+\$312
	ML2460EPF10FK	63 ¼"	24"	24"	180	\$2954	+\$296
	ML3060EPF10FK	63 ¼"	30"	24"	198	\$3093	+\$312
 <p>Full-length door on with coat rod one side, 33" high side access bookcase with 2 shelves, 1-6" box, 1-7.5" box and 1-12" file drawer on other side. Comes with 2 locks.</p>	ML2460E-BB7FK	63 ¼"	24"	24"	180	\$2954	+\$296
	ML3060E-BB7FK	63 ¼"	30"	24"	198	\$3093	+\$312
	MR2460E-BB7FK	63 ¼"	24"	24"	180	\$2954	+\$296
	MR3060E-BB7FK	63 ¼"	30"	24"	198	\$3093	+\$312
 <p>Two full-length hinged doors. Coat rod on one side and shelves on the other. Comes with 2 locks.</p>	ML2460E-HD	63 ¼"	24"	24"	140	\$2370	+\$240
	ML3060E-HD	63 ¼"	30"	24"	168	\$2544	+\$256
	MR2460E-HD	63 ¼"	24"	24"	140	\$2370	+\$240
	MR3060E-HD	63 ¼"	30"	24"	168	\$2544	+\$256



Bookcases & Display Cabinets

US Price List • June 2021

Bookcases & display cabinets

How to order

1. Specify product number.
2. Specify finish color.
3. Specify options.

Product code key example 3021-1BK15

- 30** cabinet width
- 21** interior height
- 1** number of shelves
- BK** bookcase
- 15** cabinet depth

Transform your space to show off your memorabilia, book collection or framed photos—or stow away your backpack or extra laptop bag. Our bookcases and cabinets can do more than keep or conceal, with the ability to mix materials and thousands of finish options, your storage can hide in plain sight, or promote workplace individuality.

Exterior cabinet heights are nominal. Actual heights (with glides fully recessed) are $\frac{1}{8}$ " less. Bookcases are standard with adjustable non-slotted shelves.

Finishes

Case interior and shelves match case interior paint color. Refer to [Finishes section](#) for color options.

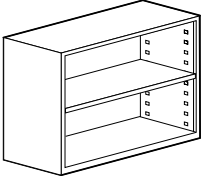
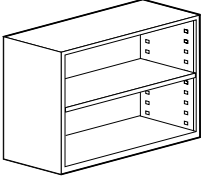
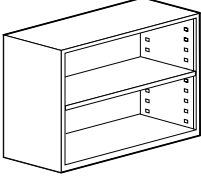
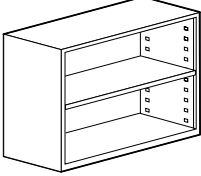
Description	Part number	Exterior Height	Width	Depth	Weight (lbs)	Neutral paint/ base price	Accent paint
 2 High Bookcase, 23 $\frac{7}{8}$ " h	1821-1BK15	23 $\frac{7}{8}$ "	18"	15"	50	\$720	+\$73
	2421-1BK15	23 $\frac{7}{8}$ "	24"	15"	50	\$734	+\$74
	3021-1BK15	23 $\frac{7}{8}$ "	30"	15"	50	\$748	+\$77
	3621-1BK15	23 $\frac{7}{8}$ "	36"	15"	50	\$762	+\$79
	4221-1BK15	23 $\frac{7}{8}$ "	42"	15"	50	\$776	+\$81
	1821-1BK18	23 $\frac{7}{8}$ "	18"	18"	50	\$720	+\$73
	2421-1BK18	23 $\frac{7}{8}$ "	24"	18"	50	\$734	+\$74
	3021-1BK18	23 $\frac{7}{8}$ "	30"	18"	50	\$748	+\$77
	3621-1BK18	23 $\frac{7}{8}$ "	36"	18"	50	\$762	+\$79
	4221-1BK18	23 $\frac{7}{8}$ "	42"	18"	50	\$776	+\$81
 2 High Bookcase, 25 $\frac{3}{8}$ " h	1822.5-1BK15	25 $\frac{3}{8}$ "	18"	15"	50	\$732	+\$74
	2422.5-1BK15	25 $\frac{3}{8}$ "	24"	15"	50	\$741	+\$76
	3022.5-1BK15	25 $\frac{3}{8}$ "	30"	15"	50	\$752	+\$77
	3622.5-1BK15	25 $\frac{3}{8}$ "	36"	15"	50	\$763	+\$79
	4222.5-1BK15	25 $\frac{3}{8}$ "	42"	15"	50	\$776	+\$81
	1822.5-1BK18	25 $\frac{3}{8}$ "	18"	18"	50	\$732	+\$74
	2422.5-1BK18	25 $\frac{3}{8}$ "	24"	18"	50	\$741	+\$76
	3022.5-1BK18	25 $\frac{3}{8}$ "	30"	18"	50	\$752	+\$77
	3622.5-1BK18	25 $\frac{3}{8}$ "	36"	18"	50	\$763	+\$79
	4222.5-1BK18	25 $\frac{3}{8}$ "	42"	18"	50	\$776	+\$81
 2 High Bookcase, 26 $\frac{7}{8}$ " h	1824-1BK15	26 $\frac{7}{8}$ "	18"	15"	60	\$726	+\$74
	2424-1BK15	26 $\frac{7}{8}$ "	24"	15"	60	\$737	+\$76
	3024-1BK15	26 $\frac{7}{8}$ "	30"	15"	60	\$748	+\$77
	3624-1BK15	26 $\frac{7}{8}$ "	36"	15"	60	\$755	+\$77
	4224-1BK15	26 $\frac{7}{8}$ "	42"	15"	60	\$768	+\$79
	1824-1BK18	26 $\frac{7}{8}$ "	18"	18"	60	\$726	+\$74
	2424-1BK18	26 $\frac{7}{8}$ "	24"	18"	60	\$737	+\$76
	3024-1BK18	26 $\frac{7}{8}$ "	30"	18"	60	\$748	+\$77
	3624-1BK18	26 $\frac{7}{8}$ "	36"	18"	60	\$755	+\$77
	4224-1BK18	26 $\frac{7}{8}$ "	42"	18"	60	\$768	+\$79
 2 High Bookcase, 29 $\frac{7}{8}$ " h	3027-1BK15	29 $\frac{7}{8}$ "	30"	15"	65	\$755	+\$77
	3627-1BK15	29 $\frac{7}{8}$ "	36"	15"	65	\$794	+\$84
	4227-1BK15	29 $\frac{7}{8}$ "	42"	15"	65	\$808	+\$85
	3027-1BK18	29 $\frac{7}{8}$ "	30"	18"	65	\$755	+\$77
	3627-1BK18	29 $\frac{7}{8}$ "	36"	18"	65	\$794	+\$84
	4227-1BK18	29 $\frac{7}{8}$ "	42"	18"	65	\$808	+\$85

Bookcases & display cabinets

How to order

1. Specify product number.
2. Specify finish color.
3. Specify options.

Product code key example

3034.5-2BK15

- 30** cabinet width
- 34.5** interior height
- 2** number of shelves
- BK** bookcase
- 15** cabinet depth

Exterior cabinet heights are nominal. Actual heights (with glides fully recessed) are 1/8" less. Bookcases are standard with adjustable non-slotted shelves.

Finishes

Case interior and shelves match case interior paint color. Refer to [Finishes section](#) for color options.

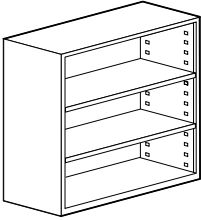
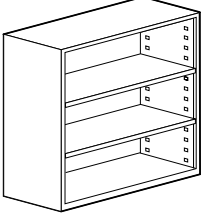
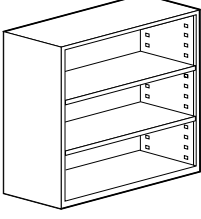
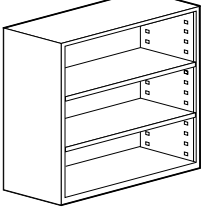
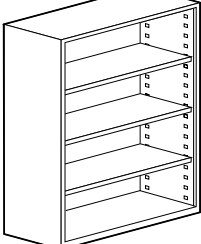
Description	Part number	Exterior Height	Width	Depth	Weight (lbs)	Neutral paint/ base price	Accent paint
 3 High Bookcase, 34 3/8" h	3031.5-2BK15	34 3/8"	30"	15"	70	\$845	+\$88
	3631.5-2BK15	34 3/8"	36"	15"	70	\$898	+\$92
	4231.5-2BK15	34 3/8"	42"	15"	70	\$916	+\$94
	3031.5-2BK18	34 3/8"	30"	18"	70	\$845	+\$88
	3631.5-2BK18	34 3/8"	36"	18"	70	\$898	+\$92
	4231.5-2BK18	34 3/8"	42"	18"	70	\$916	+\$94
 3 High Bookcase, 37 3/8" h	3034.5-2BK15	37 3/8"	30"	15"	75	\$1057	+\$107
	3634.5-2BK15	37 3/8"	36"	15"	75	\$1085	+\$111
	4234.5-2BK15	37 3/8"	42"	15"	75	\$1115	+\$114
	3034.5-2BK18	37 3/8"	30"	18"	75	\$1104	+\$112
	3634.5-2BK18	37 3/8"	36"	18"	75	\$1127	+\$115
	4234.5-2BK18	37 3/8"	42"	18"	75	\$1165	+\$119
 3 High Bookcase, 38 7/8" h	3036-2BK15	38 7/8"	30"	15"	80	\$1087	+\$111
	3636-2BK15	38 7/8"	36"	15"	80	\$1115	+\$114
	4236-2BK15	38 7/8"	42"	15"	80	\$1143	+\$118
	3036-2BK18	38 7/8"	30"	18"	80	\$1127	+\$115
	3636-2BK18	38 7/8"	36"	18"	80	\$1149	+\$118
	4236-2BK18	38 7/8"	42"	18"	80	\$1188	+\$121
 3 High Bookcase, 40 3/8" h	3037.5-2BK15	40 3/8"	30"	15"	80	\$1133	+\$116
	3637.5-2BK15	40 3/8"	36"	15"	80	\$1157	+\$119
	4237.5-2BK15	40 3/8"	42"	15"	80	\$1180	+\$121
	3037.5-2BK18	40 3/8"	30"	18"	80	\$1169	+\$120
	3637.5-2BK18	40 3/8"	36"	18"	80	\$1186	+\$121
	4237.5-2BK18	40 3/8"	42"	18"	80	\$1220	+\$125
 4 High Bookcase, 44 7/8" h	3042-3BK15	44 7/8"	30"	15"	85	\$1211	+\$124
	3642-3BK15	44 7/8"	36"	15"	85	\$1245	+\$127
	4242-3BK15	44 7/8"	42"	15"	85	\$1260	+\$129
	3042-3BK18	44 7/8"	30"	18"	85	\$1279	+\$130
	3642-3BK18	44 7/8"	36"	18"	85	\$1294	+\$132
	4242-3BK18	44 7/8"	42"	18"	85	\$1304	+\$132

Bookcases & display cabinets

How to order

1. Specify product number.
2. Specify finish color.
3. Specify options.

Product code key example

3048-3BK15

- 30** cabinet width
- 48** interior height
- 3** number of shelves
- BK** bookcase
- 15** cabinet depth

Exterior cabinet heights are nominal. Actual heights (with glides fully recessed) are $\frac{1}{8}$ " less. Bookcases are standard with adjustable non-slotted shelves.

Finishes

Case interior and shelves match case interior paint color. Refer to [Finishes section](#) for color options.

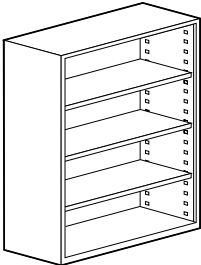
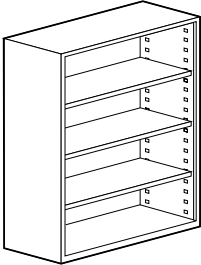
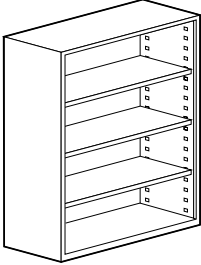
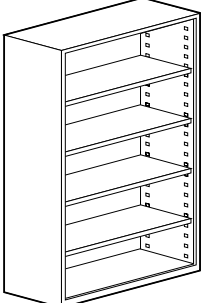
Description	Part number	Exterior Height	Width	Depth	Weight (lbs)	Neutral paint/ base price	Accent paint
 <p>4 High Bookcase, 46 $\frac{3}{8}$" h</p>	3043.5-3BK15	46 $\frac{3}{8}$ "	30"	15"	100	\$1232	+\$126
	3643.5-3BK15	46 $\frac{3}{8}$ "	36"	15"	100	\$1239	+\$127
	4243.5-3BK15	46 $\frac{3}{8}$ "	42"	15"	100	\$1261	+\$129
	3043.5-3BK18	46 $\frac{3}{8}$ "	30"	18"	100	\$1287	+\$131
	3643.5-3BK18	46 $\frac{3}{8}$ "	36"	18"	100	\$1327	+\$134
	4243.5-3BK18	46 $\frac{3}{8}$ "	42"	18"	100	\$1356	+\$138
 <p>4 High Bookcase, 50 $\frac{7}{8}$" h</p>	3048-3BK15	50 $\frac{7}{8}$ "	30"	15"	100	\$1260	+\$129
	3648-3BK15	50 $\frac{7}{8}$ "	36"	15"	100	\$1276	+\$130
	4248-3BK15	50 $\frac{7}{8}$ "	42"	15"	100	\$1287	+\$131
	3048-3BK18	50 $\frac{7}{8}$ "	30"	18"	100	\$1298	+\$132
	3648-3BK18	50 $\frac{7}{8}$ "	36"	18"	100	\$1330	+\$135
	4248-3BK18	50 $\frac{7}{8}$ "	42"	18"	100	\$1379	+\$140
 <p>4 High Bookcase, 52 $\frac{3}{8}$" h</p>	3049.5-3BK15	52 $\frac{3}{8}$ "	30"	15"	100	\$1264	+\$129
	3649.5-3BK15	52 $\frac{3}{8}$ "	36"	15"	100	\$1280	+\$130
	4249.5-3BK15	52 $\frac{3}{8}$ "	42"	15"	100	\$1290	+\$131
	3049.5-3BK18	52 $\frac{3}{8}$ "	30"	18"	100	\$1313	+\$133
	3649.5-3BK18	52 $\frac{3}{8}$ "	36"	18"	100	\$1353	+\$138
	4249.5-3BK18	52 $\frac{3}{8}$ "	42"	18"	100	\$1385	+\$140
 <p>4 High Bookcase, 55 $\frac{3}{8}$" h</p>	3052.5-4BK15	55 $\frac{3}{8}$ "	30"	15"	105	\$1368	+\$139
	3652.5-4BK15	55 $\frac{3}{8}$ "	36"	15"	105	\$1396	+\$141
	4252.5-4BK15	55 $\frac{3}{8}$ "	42"	15"	105	\$1449	+\$146
	3052.5-4BK18	55 $\frac{3}{8}$ "	30"	18"	105	\$1438	+\$145
	3652.5-4BK18	55 $\frac{3}{8}$ "	36"	18"	105	\$1463	+\$147
	4252.5-4BK18	55 $\frac{3}{8}$ "	42"	18"	105	\$1525	+\$154

Bookcases & display cabinets

How to order

1. Specify product number.
2. Specify finish color.
3. Specify options.

Product code key example

3054-4BK15

- 30** cabinet width
- 54** interior height
- 4** number of shelves
- BK** bookcase
- 15** cabinet depth

Exterior cabinet heights are nominal. Actual heights (with glides fully recessed) are $\frac{1}{8}$ " less. Bookcases are standard with adjustable non-slotted shelves.

Finishes

Case interior and shelves match case interior paint color. Refer to [Finishes section](#) for color options.

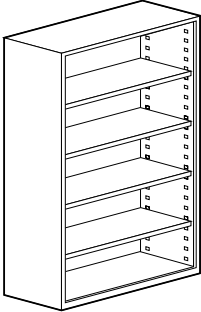
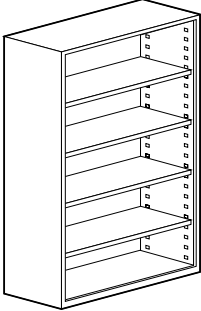
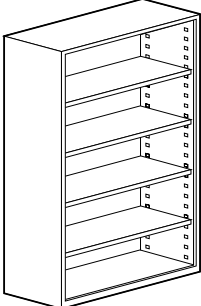
Description	Part number	Exterior Height	Width	Depth	Weight (lbs)	Neutral paint/ base price	Accent paint	
 <p>5 High Bookcase, 56 $\frac{7}{8}$" h</p>	3054-4BK15	56 $\frac{7}{8}$ "	30"	15"	105	\$1429	+\$144	
	3654-4BK15	56 $\frac{7}{8}$ "	36"	15"	105	\$1455	+\$146	
	4254-4BK15	56 $\frac{7}{8}$ "	42"	15"	105	\$1460	+\$147	
	3054-4BK18	56 $\frac{7}{8}$ "	30"	18"	105	\$1446	+\$146	
	3654-4BK18	56 $\frac{7}{8}$ "	36"	18"	105	\$1489	+\$151	
	4254-4BK18	56 $\frac{7}{8}$ "	42"	18"	105	\$1532	+\$156	
	 <p>5 High Bookcase, 58 $\frac{3}{8}$" h</p>	3055.5-4BK15	58 $\frac{3}{8}$ "	30"	15"	115	\$1443	+\$145
		3655.5-4BK15	58 $\frac{3}{8}$ "	36"	15"	115	\$1460	+\$147
		4255.5-4BK15	58 $\frac{3}{8}$ "	42"	15"	115	\$1467	+\$147
3055.5-4BK18		58 $\frac{3}{8}$ "	30"	18"	115	\$1455	+\$146	
3655.5-4BK18		58 $\frac{3}{8}$ "	36"	18"	115	\$1502	+\$152	
4255.5-4BK18		58 $\frac{3}{8}$ "	42"	18"	115	\$1547	+\$157	
 <p>5 High Bookcase, 59 $\frac{7}{8}$" h</p>		3057-4BK15	59 $\frac{7}{8}$ "	30"	15"	115	\$1449	+\$146
		3657-4BK15	59 $\frac{7}{8}$ "	36"	15"	115	\$1463	+\$147
		4257-4BK15	59 $\frac{7}{8}$ "	42"	15"	115	\$1470	+\$148
	3057-4BK18	59 $\frac{7}{8}$ "	30"	18"	115	\$1458	+\$147	
	3657-4BK18	59 $\frac{7}{8}$ "	36"	18"	115	\$1507	+\$153	
	4257-4BK18	59 $\frac{7}{8}$ "	42"	18"	115	\$1554	+\$159	

Bookcases & display cabinets

How to order

1. Specify product number.
2. Specify finish color.
3. Specify options.

Product code key example

3060-4BK15

- 30** cabinet width
- 60** interior height
- 4** number of shelves
- BK** bookcase
- 15** cabinet depth

Exterior cabinet heights are nominal. Actual heights (with glides fully recessed) are $\frac{1}{8}$ " less. Bookcases are standard with adjustable non-slotted shelves.

Finishes

Case interior and shelves match case interior paint color. Refer to [Finishes section](#) for color options.

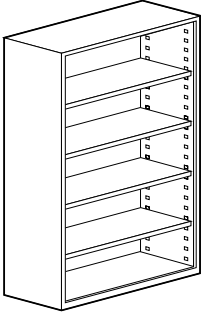
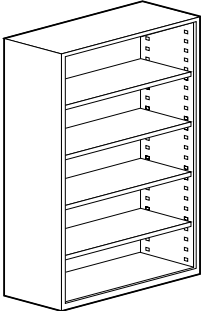
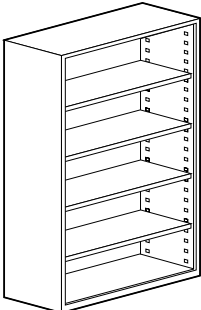
Description	Part number	Exterior Height	Width	Depth	Weight (lbs)	Neutral paint/ base price	Accent paint
 <p>5 High Bookcase, 61 $\frac{3}{8}$" h</p>	3058.5-4BK15	61 $\frac{3}{8}$ "	30"	15"	123	\$1455	+\$146
	3658.5-4BK15	61 $\frac{3}{8}$ "	36"	15"	123	\$1469	+\$148
	4258.5-4BK15	61 $\frac{3}{8}$ "	42"	15"	123	\$1474	+\$148
	3058.5-4BK18	61 $\frac{3}{8}$ "	30"	18"	123	\$1469	+\$148
	3658.5-4BK18	61 $\frac{3}{8}$ "	36"	18"	123	\$1520	+\$154
	4258.5-4BK18	61 $\frac{3}{8}$ "	42"	18"	123	\$1558	+\$159
 <p>5 High Bookcase, 62 $\frac{7}{8}$" h</p>	3060-4BK15	62 $\frac{7}{8}$ "	30"	15"	130	\$1464	+\$147
	3660-4BK15	62 $\frac{7}{8}$ "	36"	15"	130	\$1479	+\$148
	4260-4BK15	62 $\frac{7}{8}$ "	42"	15"	130	\$1488	+\$151
	3060-4BK18	62 $\frac{7}{8}$ "	30"	18"	130	\$1488	+\$151
	3660-4BK18	62 $\frac{7}{8}$ "	36"	18"	130	\$1503	+\$152
	4260-4BK18	62 $\frac{7}{8}$ "	42"	18"	130	\$1566	+\$160
 <p>5 High Bookcase, 64 $\frac{3}{8}$" h</p>	3061.5-4BK15	64 $\frac{3}{8}$ "	30"	15"	130	\$1476	+\$148
	3661.5-4BK15	64 $\frac{3}{8}$ "	36"	15"	130	\$1488	+\$151
	4261.5-4BK15	64 $\frac{3}{8}$ "	42"	15"	130	\$1489	+\$151
	3061.5-4BK18	64 $\frac{3}{8}$ "	30"	18"	130	\$1495	+\$152
	3661.5-4BK18	64 $\frac{3}{8}$ "	36"	18"	130	\$1518	+\$154
	4261.5-4BK18	64 $\frac{3}{8}$ "	42"	18"	130	\$1577	+\$161

Bookcases & display cabinets

How to order

1. Specify product number.
2. Specify finish color.
3. Specify options.

Product code key example

3063-4BK15

- 30** cabinet width
- 63** interior height
- 4** number of shelves
- BK** bookcase
- 15** cabinet depth

Exterior cabinet heights are nominal. Actual heights (with glides fully recessed) are 1/8" less. Bookcases are standard with adjustable non-slotted shelves.

Finishes

Case interior and shelves match case interior paint color. Refer to [Finishes section](#) for color options.

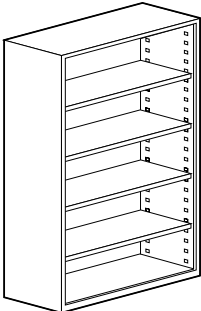
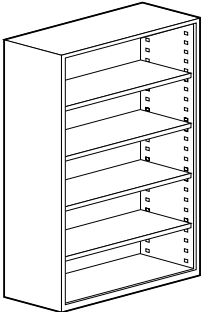
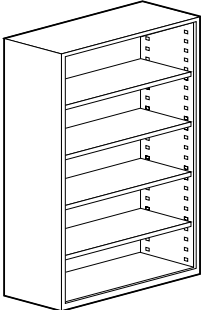
Description	Part number	Exterior Height	Width	Depth	Weight (lbs)	Neutral paint/ base price	Accent paint	
 <p>5 High Bookcase, 65 7/8" h</p>	3063-4BK15	65 7/8"	30"	15"	130	\$1479	+\$148	
	3663-4BK15	65 7/8"	36"	15"	130	\$1490	+\$151	
	4263-4BK15	65 7/8"	42"	15"	130	\$1491	+\$151	
	3063-4BK18	65 7/8"	30"	18"	130	\$1502	+\$152	
	3663-4BK18	65 7/8"	36"	18"	130	\$1518	+\$154	
	4263-4BK18	65 7/8"	42"	18"	130	\$1582	+\$161	
	 <p>5 High Bookcase, 67 3/8" h</p>	3064.5-4BK15	67 3/8"	30"	15"	135	\$1500	+\$152
		3664.5-4BK15	67 3/8"	36"	15"	135	\$1503	+\$152
		4264.5-4BK15	67 3/8"	42"	15"	135	\$1504	+\$153
3064.5-4BK18		67 3/8"	30"	18"	135	\$1512	+\$153	
3664.5-4BK18		67 3/8"	36"	18"	135	\$1529	+\$156	
4264.5-4BK18		67 3/8"	42"	18"	135	\$1592	+\$162	
 <p>5 High Bookcase, 68 7/8" h</p>	3066-4BK15	68 7/8"	30"	15"	135	\$1507	+\$153	
	3666-4BK15	68 7/8"	36"	15"	135	\$1514	+\$153	
	4266-4BK15	68 7/8"	42"	15"	135	\$1515	+\$154	
	3066-4BK18	68 7/8"	30"	18"	135	\$1520	+\$154	
	3666-4BK18	68 7/8"	36"	18"	135	\$1534	+\$156	
	4266-4BK18	68 7/8"	42"	18"	135	\$1595	+\$162	

Bookcases & display cabinets

How to order

1. Specify product number.
2. Specify finish color.
3. Specify options.

Product code key example



3067.5-4BK15

- 30** cabinet width
- 67.5** interior height
- 4** number of shelves
- BK** bookcase
- 15** cabinet depth

Exterior cabinet heights are nominal. Actual heights (with glides fully recessed) are 1/8" less. Bookcases are standard with adjustable non-slotted shelves.

Finishes

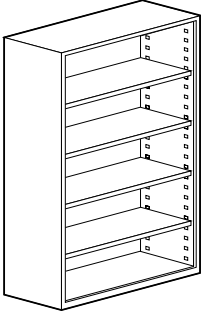
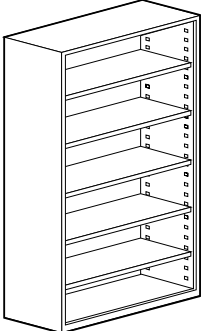
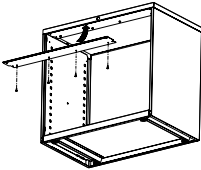
Case interior and shelves match case interior paint color. Refer to [Finishes section](#) for color options.

Description	Part number	Exterior Height	Width	Depth	Weight (lbs)	Neutral paint/ base price	Accent paint
 <p>5 High Bookcase, 70 3/8" h</p>	3067.5-4BK15	70 3/8"	30"	15"	135	\$1516	+\$154
	3667.5-4BK15	70 3/8"	36"	15"	135	\$1518	+\$154
	4267.5-4BK15	70 3/8"	42"	15"	135	\$1527	+\$156
	3067.5-4BK18	70 3/8"	30"	18"	135	\$1532	+\$156
	3667.5-4BK18	70 3/8"	36"	18"	135	\$1543	+\$157
	4267.5-4BK18	70 3/8"	42"	18"	135	\$1602	+\$164
 <p>6 High Bookcase, 70 3/8" h</p>	3067.5-5BK15	70 3/8"	30"	15"	135	\$1614	+\$164
	3667.5-5BK15	70 3/8"	36"	15"	135	\$1618	+\$165
	4267.5-5BK15	70 3/8"	42"	15"	135	\$1628	+\$165
	3067.5-5BK18	70 3/8"	30"	18"	135	\$1628	+\$165
	3667.5-5BK18	70 3/8"	36"	18"	135	\$1642	+\$167
	4267.5-5BK18	70 3/8"	42"	18"	135	\$1704	+\$172
 <p>Bookcase top cover</p>	BKTC-18	—	18"	—	3	\$33	+\$7
	BKTC-24	—	24"	—	3	\$33	+\$7
	BKTC-30	—	30"	—	3	\$33	+\$7
	BKTC-36	—	36"	—	3	\$35	+\$7
	BKTC-42	—	42"	—	3	\$37	+\$8
 <p>Adjustable non-slotted shelf</p>	BKSH-3015	1/2"	30"	15"	11	\$99	+\$13
	BKSH-3615	1/2"	36"	15"	11	\$101	+\$13
	BKSH-4215	1/2"	42"	15"	11	\$103	+\$13
	BKSH-3018	1/2"	30"	18"	11	\$99	+\$13
	BKSH-3618	1/2"	36"	18"	11	\$101	+\$13
	BKSH-4218	1/2"	42"	18"	11	\$103	+\$13

Bookcases & display cabinets

How to order

1. Specify product number.
2. Specify finish color.
3. Specify options.

Product code key example

36-2MS

- 36** cabinet width
2 number of shelves
MS display shelf

Exterior cabinet heights are nominal. Actual heights (with glides fully recessed) are $\frac{1}{8}$ " less.

Display Cabinets offer addition storage behind the lift-up display shelves.

Finishes

Case interior and shelves match case interior paint color. Refer to [Finishes section](#) for color options.

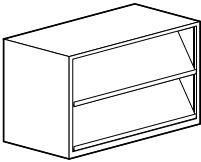
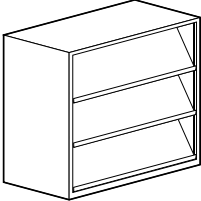
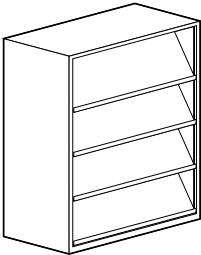
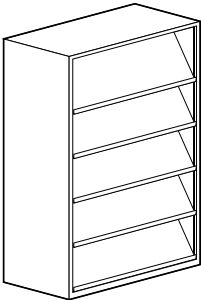
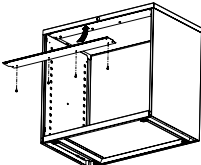
Description	Part number	Exterior Height	Width	Depth	Weight (lbs)	Neutral paint/ base price	Accent paint
 2 high display cabinet with sloped display shelves	30-2MS	26 $\frac{7}{8}$ "	30"	18"	100	\$787	+\$83
	36-2MS	26 $\frac{7}{8}$ "	36"	18"	125	\$832	+\$87
	42-2MS	26 $\frac{7}{8}$ "	42"	18"	135	\$915	+\$94
 3 high display cabinet with sloped display shelves	36-3MS	38 $\frac{7}{8}$ "	36"	18"	100	\$1127	+\$115
 4 high display cabinet with sloped display shelves, no tie bar	36-4MS	52 $\frac{3}{8}$ "	36"	18"	130	\$1442	+\$145
 5 high display cabinet with sloped display shelves, no tie bar	36-5MS	64 $\frac{3}{8}$ "	36"	18"	160	\$1710	+\$173
 Bookcase top cover	BKTC-30	—	30"	—	3	\$33	+\$7
	BKTC-36	—	36"	—	3	\$35	+\$7
	BKTC-42	—	42"	—	3	\$37	+\$8

Bookcases & display cabinets

Bookcase Lateral Combinations

How to order

1. Specify product number.
2. Specify finish color.
3. Specify options.

Product code key example



3067.5-4BK15

30 cabinet width
67.5 interior height
4 number of shelves
BK bookcase
15 cabinet depth

Exterior cabinet heights are nominal. Actual heights (with glides fully recessed) are $\frac{1}{8}$ " less. Bookcases are standard with adjustable non-slotted shelves.

Finishes

Case interior and shelves match case interior paint color. Refer to [Finishes section](#) for color options.

	Description	Part number	Exterior Height	Width	Depth	Weight (lbs)	Neutral paint/ base price	Accent paint
	13.5 bookcase Insert, 10.5" file Flat Glides	30-24-BKF10E	26 $\frac{7}{8}$ "	30"	18"	100	\$1092	+\$111
		36-24-BKF10E	26 $\frac{7}{8}$ "	36"	18"	125	\$1170	+\$120
		42-24-BKF10E	26 $\frac{7}{8}$ "	42"	18"	135	\$1272	+\$130
	7.5" box, 16.5" bookcase insert Flat Glides	3024-B7BKE	26 $\frac{7}{8}$ "	30"	18"	98	\$1209	+\$124
		3624-B7BKE	26 $\frac{7}{8}$ "	36"	18"	108	\$1286	+\$131
		4224-B7BKE	26 $\frac{7}{8}$ "	42"	18"	121	\$1386	+\$140



Waste & Recycle Bins

US Price List • June 2021

Waste & Recycle Bins

How to order

1. Specify product number.
2. Specify finish color.
3. Specify options.

Product code key example V1518EM-F24R

V	vertical file
15	width
18	depth
EM	9900 series front
F	Fixed front
24	interior dimension
R	recycling unit

Our Waste + Recycle helps to create a cleaner, more attractive space while optimizing limited real estate in the workplace. It is designed for collaborative spaces, cafés, lunch rooms, or anywhere you would like to encourage recycling. Featuring a pull-out drawer, users can easily access the included 41 quart plastic bins, making emptying them easy.

Exterior cabinet heights are nominal. Actual heights (with glides fully recessed) are $\frac{1}{8}$ " less. **Vertical depths are nominal. Actual depth for 9900 Series are $\frac{3}{4}$ " more.**

Counterweights

Counterweights MUST be specified separately if the Waste & Recycling Bins are used in a freestanding application. See [Counterweight matrix](#). Add \$144 for a counterweight.

Accessories



See [Vertical File Accessories](#) section for counterweights and accessories. Clear plastic label holders are available at no charge.

Lock option

A lock is not included with these cabinets.

Finishes

Available in all standard paint colors. Refer to [Finishes section](#) for color options. A contrasting color may be selected for the drawer front liner at no additional upcharge. Drawer bodies and accessories are finished in Eco Black.

	Description	Part number	Height	Width	Case Depth	Weight (lbs)	Neutral paint/ base price	Case Accent paint
	9900 Series Vertical File with Pullout Recycle Drawer Bin included Worksurface supporting	V1518EM-F24R	26 $\frac{7}{8}$ "	15"	18"	—	\$922	+\$107
	9900 Series Vertical File with Pullout Recycle Drawer and 4.5" Box Drawer Above Bin included	V1518EMB4F24TBR	32 $\frac{7}{8}$ "	15"	18"	—	\$1191	+\$139
	Recycle Bin Replacment	RECYCLEBIN	19 $\frac{7}{8}$ "	11"	15 $\frac{1}{4}$ "	—	\$45	—

Waste & Recycle Bins

How to order

1. Specify product number.
2. Specify finish color.
3. Specify options.

Product code key example V1518EM-F24W

V	vertical file
15	width
18	depth
EM	9900 series front
F	Fixed front
24	interior dimension
W	waste unit

Our Waste + Recycle Bins helps to create a cleaner, more attractive space while optimizing limited real estate in the workplace. It is designed for collaborative spaces, cafés, lunch rooms, or anywhere you would like to encourage recycling. Featuring a pull-out drawer, users can easily access the included 41 quart plastic bins, making emptying them easy.

Exterior cabinet heights are nominal. Actual heights (with glides fully recessed) are $\frac{1}{8}$ " less. **Vertical depths are nominal. Actual depth for 9900 Series are $\frac{3}{4}$ " more.**

Counterweights

Counterweights **MUST** be specified separately if the Waste & Recycling Bins are used in a freestanding application. See [Counterweight matrix](#). Add \$144 for a counterweight.

Accessories



See [Vertical File Accessories](#) section for counterweights and accessories. Clear plastic label holders are available at no charge.

Lock option

A lock is not included with these cabinets.

Finishes

Available in all standard paint colors. Refer to [Finishes section](#) for color options. A contrasting color may be selected for the drawer front liner behind the pullout front symbol at no additional upcharge. Drawer bodies and accessories are finished in Eco Black.

	Description	Part number	Height	Width	Case Depth	Weight (lbs)	Neutral paint/ base price	Case Accent paint
	9900 Series Vertical File with Pullout Waste Drawer Bin included Worksurface supporting	V1518EM-F24W	26 $\frac{7}{8}$ "	15"	18"	—	\$903	+\$106
	9900 Series Vertical File with Pullout Waste Drawer and 4.5" Box Drawer Above Bin included	V1518EMB4F24TBW	32 $\frac{7}{8}$ "	—	18"	—	\$1171	+\$137
	Waste Bin Replacement	WASTEBIN	19 $\frac{7}{8}$ "	11"	15 $\frac{1}{4}$ "	—	\$32	—



Storage with Handles

US Price List • June 2021

ANSI/BIFMA

With the addition of counterweights where appropriate, pedestal meet all ANSI/BIFMA specifications.

Construction

Pedestals are welded, “wrap-around” construction using 20 and 22 gauge high quality, tension leveled, cold rolled steel. The steel gauges selected for drawer fronts, bodies and accessories ensure the highest quality durability and performance for all components.

Construction Features & Benefits

1. Completely enclosed case provides rigid construction and dust-free interiors.
2. Box drawer sides are slotted on 1” centers to allow for maximum flexibility for drawer division.
3. File (10½” and 12”) drawer bodies have full height sides to accommodate hanging file folders, eliminating the need for optional file frames.
4. Fully-progressive ball bearing suspensions on all drawers, including pencil and box drawers, are staged so that left and right sides work in unison. This provides smooth drawer operation with minimum force.
5. Staged suspensions allow the drawer to be completely pulled out, providing access to the entire drawer depth.
6. Special “claw-like” device incorporated in the suspension “grips” the fixed section of the suspension arm preventing drawer bounce-back or creep when drawer is closed.
7. Casters and glides are both recessed “inboard” for a uniform exterior appearance with no visible hardware.
8. Modular interior allows for complete interchangeability of drawer types within the pedestal case. For example, two 6” box drawers may be replaced by one 12” file drawer.
9. 18” deep pedestals come standard with 18” deep drawers. 22” and 28” deep pedestals come standard with 22” deep drawers.

Counterweights

Counterweights are required for ALL freestanding units that are not anchored or ganged to other cabinets or bolted to walls/floor.

Counterweights come standard with ALL mobile pedestals and must be field installed.

Drawer Standard Equipment

15” letter width storage drawers: 3” pencil drawer, 6” box drawer, 10½” and 12” file drawer are standard.

Pedestals containing 3” or 6” drawers have the option to order one pencil tray per pedestal. 6” drawers have the additional option to order one steel divider.

10½” and 12” letter-width file drawers have the option to order suspension bar (two in a 28” deep pedestal) for side-to-side filing of legal or letter-size folders.

Refer to [accessories section](#) for codes and pricing.

Bases

Optional base aprons are available in 2 standard heights and are screwed to the underside of the pedestal case. Bases may be easily added or changed on site. Pedestals are shipped with bases installed when ordered.

Casters

Four swivel, recessed 1½” black, double-wheel phenolic carpet casters are supplied with mobile pedestals and must be field installed.

Glides

Overall heights are inclusive of metal glides. Heights may be increased up to ¾” by extending standard glide. Glides are accessible from inside the pedestal when the bottom drawer is fully extended or removed and may be adjusted with a ¼” socket driver.

Optional 1½” stem glides are available. Specify separately and add \$30 list to the pedestal price. Requires field installation.

Locks

Pedestals come standard with lock. If lock is not required add suffix ‘/NL’ after product number. Deduct \$57 list per lock. For lock location, see the front of this price list. Mobile pedestals must include locks.

Random keying is standard. Pedestals may be ordered keyed alike. Specify. Locks feature removable core and are standard with two keys, one of which has a black neoprene plastic key cover.

Cabinets originally ordered as non-locking may be field installed with the addition of locking bars and a lock core. Please contact Office Specialty Client Services for required parts.



Master keys are available at \$51 list.

Finishes

Refer to [Finishes section](#) for color options. For lock finish options, refer to the front of this price list.

Drawer Pulls

Storage with Handles have the following style options. FP005 is the default pull.

Pull	Storage with Handles	Nuform
 <p>FP001 P290 Aluminum Leaf Finish</p>		
 <p>FP004 Brushed Nickel Finish</p>		
 <p>FP005 Brushed Nickel Finish</p>		

Available

Unavailable

Pulls FP004 and FP005 meet the guidelines for ADA compliance.

Storage with Handles

Pedestals
Freestanding, Letter Width

How to order

1. Specify product number.
2. Specify finish color.
3. Specify options.

Product code key example 1518H-2BF10

- 15** -pedestal width
18 -pedestal depth
H -Storage with Handles
2 -number of drawers
B -6" box
F10 -10 1/2" file drawer

Pedestals are standard with either glides or casters.
Exterior pedestal heights are nominal.

Counterweights

Counterweights are required for ALL freestanding units that are not anchored or ganged to other cabinets or bolted to walls/floor. Counterweights are standard with all mobile pedestals and must be field installed. See [Counterweight matrix](#).

See [Pedestal Accessories](#) section for counterweight codes and pricing.

Lock option

Pedestals come standard with lock. If lock is not required add suffix '/NL' after product number. Deduct \$57 list.

Finishes



Refer to [Finishes section](#) for color options. Drawer bodies and accessories are finished in Eco Black.

Optional Accessories

All pedestal accessories are optional. See chart below for information on accessories by drawer height.

Drawer Height	Product Code	Product Description	Price
3" & 4.5"	WS-PTxx	Pencil Tray	\$37
6" & 7.5"	WS-PTxx	Pencil Tray	\$37
	WS-DVxx	Divider	\$22
18"D, 22"D, 28"D Pedestals Only (28"D requires 2 per drawer)			
10.5", 12", 13.5, & 15"	SSFxx	Side-To-Side Filing Bar	\$8

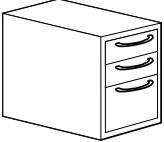
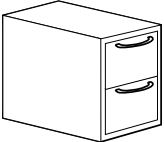
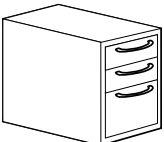
Visit the [Pedestal Accessories](#) section for full accessory details.

	Description	Part number	Height	Depth	Weight (lbs)	Neutral point/ base price	Accent point
	2 box, 1-10.5" file glides	1518H-2BF10	25 3/8"	18"	90	\$904	+\$93
		1522H-2BF10	25 3/8"	22"	90	\$1023	+\$104
		1528H-2BF10	25 3/8"	28"	100	\$1077	+\$110
	2 box, 1-10.5" file, mobile, counterweights are included Mobile pedestals must be locking	1518H-2BF10M	26"	18"	85	\$1089	+\$111
		1522H-2BF10M	26"	22"	95	\$1207	+\$124
		1528H-2BF10M	26"	28"	100	\$1260	+\$129
	1-10.5" file, 1-12" file glides	1518H-F10F	25 3/8"	18"	80	\$831	+\$87
		1522H-F10F	25 3/8"	22"	90	\$899	+\$93
		1528H-F10F	25 3/8"	28"	100	\$927	+\$96
	1-10.5" file, 1-12" file, mobile, counterweights are included Mobile pedestals must be locking	1518H-F10FM	26"	18"	85	\$1018	+\$104
		1522H-F10FM	26"	22"	95	\$1089	+\$111
		1528H-F10FM	26"	28"	100	\$1118	+\$114
	2 box, 1-12" file glides	1518H-2BF	26 7/8"	18"	80	\$904	+\$93
		1522H-2BF	26 7/8"	22"	90	\$1023	+\$104
		1528H-2BF	26 7/8"	28"	100	\$1077	+\$110

Storage with Handles

How to order

1. Specify product number.
2. Specify finish color.
3. Specify options.

Product code key example 1518H-B7F10MCNH

15	pedestal width
18	pedestal depth
H	Storage with Handles
B7	7½" box
F10	10 ½" file drawer
M	mobile
C	cushion
NH	no handle

The **Classic Cushion** is 1 ¼" thick CAL 117 compliant polyurethane foam with a 2.3 lb/ft. density. This upholstered cushion is balanced with a 7/16" board and is attached to the pedestal top with heavy duty Velcro. The 5-pc construction, features double row top stitching on all seams, seen in fine upholstered pieces. The result provides crisp rectilinear styling.

For application of ALL fabrics, both from our graded program as well as COM (customers own material), please specify layup orientation at time of order. If layup instructions are not provided we will choose the direction to maximize our production. Refer to [Additional layout and COM details](#).

Counterweights

Counterweights are required for ALL freestanding units that are not anchored or ganged to other cabinets or bolted to walls/floor. Counterweights are standard with all mobile pedestals and must be field installed. See [Counterweight matrix](#).

See [Pedestal Accessories](#) section for counterweight codes and pricing.

Finishes

Refer to [Finishes section](#) for color options. Drawer bodies and accessories are finished in Eco Black.

Optional Accessories

All pedestal accessories are optional. See chart below for information on accessories by drawer height.

Drawer Height	Product Code	Product Description	Price
3" & 4.5"	WS-PTxx	Pencil Tray	\$37
6" & 7.5"	WS-PTxx	Pencil Tray	\$37
	WS-DVxx	Divider	\$22

18"D, 22"D, 28"D Pedestals Only (28"D requires 2 per drawer)

Drawer Height	Product Code	Product Description	Price
10.5", 12", 13.5, & 15"	SSFxx	Side-To-Side Filing Bar	\$8

Visit the [Pedestal Accessories](#) section for full accessory details.

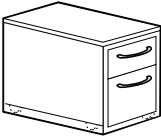
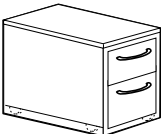
Description	Part number	Height	Depth	Weight (lbs)	Neutral paint/ base price (grade A fabric)	Accent paint
 <p>Cushion pedestal 1-6" box, 1-12" file drawer, mobile, without handle, counterweights are included Mobile pedestals must be locking</p>	1518H-BFMCNH	22 ½"	18"	93	\$1124	+\$115
	1522H-BFMCNH	22 ½"	22"	105	\$1165	+\$119
	1528H-BFMCNH	22 ½"	28"	117	\$1212	+\$125
 <p>Cushion pedestal 1-7½" box, 1-10.5" file drawer, mobile, without handle, counterweights are included Mobile pedestals must be locking</p>	1518H-B7F10MCNH	22 ½"	18"	93	\$1089	+\$111
	1522H-B7F10MCNH	22 ½"	22"	105	\$1212	+\$125
	1528H-B7F10MCNH	22 ½"	28"	117	\$1260	+\$129

Fabric upcharge for mobile cushion pedestals - [Classic Cushion option only](#)

Note: To price fabric grade options add the upcharge (+\$) in the chart below to the base price of the List price (Grade A) column. This will be the total cost for that product.

Grade B/COM	Grade C	Grade D	Grade E	Grade F
+\$57	+\$103	+\$145	+\$174	+\$249

ANSI/BIFMA

With the addition of counterweights where appropriate, lateral files meet all ANSI/BIFMA specifications.

Construction

Lateral files and hinged door cabinets are of all-welded construction using 20 and 22 gauge high quality, tension leveled, cold rolled steel. The steel gauges selected for drawer fronts, bodies and accessories ensure the highest quality durability and performance for all components.

Construction features & benefits

- All interiors are modular and interchangeable so that cabinets can be retrofitted with new accessories and interiors as required.
- Lift-up door carrier mechanism has four nylon rollers, two on each side, for smooth receding action with no binding or snagging.
- Front leading edge of pullout shelves is beaded and rolled to provide grip for pullout action and to strengthen shelf; front leading edge of fixed shelf is flat for easy removal of material.
- Fully-progressive ball bearing suspensions are staged so that left and right sides work in unison. This provides smooth drawer operation with minimum force.
- Special "claw-like" device incorporated in suspensions "grips" the fixed section of the suspension arm preventing drawer bounce-back or creep when drawer is closed.
- Lock bars operate vertically on both sides of the cabinet for maximum security.
- Lock fingers are configured with right angle bend upward, not downward, so that lift-up doors cannot be pulled down to disengage fingers from door slots and be forced to circumvent lock system.
- Plastic buttons in side gables of case where top sections of lift-up doors recede into the cabinet eliminate metal-to-metal contact.
- Plastic buttons in the ends of each drawer and door front eliminates metal-to-metal contact between cabinet sides and closed drawers.
- Self-closing, 110° opening, European style cupboard hinges provide smooth hinged door operation. Hinges are not visible from the exterior of the cabinet.

Counterweights

Counterweights are required for ALL freestanding units that are not anchored or ganged to other cabinets or bolted to walls/floor.

Safelock™

The patented Safelock mechanism provides complete security against accidental opening of two or more drawers simultaneously. When any drawer or single pullout shelf is extended, even fractionally, Safelock ensures that all other openings, except for the 3" and 4½" drawers, immediately become inoperable. Safelock is standard on all lateral files. The only exceptions are the 3" and 4½" drawers and the upper shelf in a two pullout shelf opening.

Drawer standard equipment

Pullout drawers are standard with one pair hangfile bars for side-to-side suspended filing. Optional accessories are available.

Bases

Optional base aprons are available in 2 heights and are screwed to the underside of the cabinet. Bases may be easily added or changed on site. Cabinets are shipped with bases installed when ordered.

Glides

Overall heights are inclusive of metal glides. Heights may be increased up to 5/8" by extending standard glide. Glides are accessible from inside the cabinet when the bottom drawer is fully extended or removed and may be adjusted with a ¼" socket driver.

Optional 1½" stem glides are available. Specify separately and add \$30 list to the cabinet price. Requires field installation.

Locks

Cabinets come standard with lock. If lock is not required add suffix '/NL' after product number. Deduct \$57 list per lock. For lock location, see the guide at the beginning of this price list.

Random keying is standard. Files may be ordered keyed alike. Specify. Locks feature removable core and are standard with two keys, one of which has a black neoprene plastic key cover.

Cabinets originally ordered as non-locking may be field installed with the addition of locking bars and a lock core. Please contact Office Specialty Client Services for required parts.

Master keys are available at \$51 list.

Lateral file tops



Refer to [Accessories section](#) to order Laminate and Nuform tops.

Finishes

Refer to [Finishes section](#) for color options. For lock finish options, refer to the front of this price list.

Drawer Pulls

Storage with Handles have the following style options. FP005 is the default pull.

Pull	Storage with Handles	Nuform
 FP001 P290 Aluminum Leaf Finish		
 FP004 Brushed Nickel Finish		
 FP005 Brushed Nickel Finish		

Available

Unavailable

Pulls FP004 and FP005, meet the guidelines for ADA compliance.

Note: Cabinets with hinged doors do not have pull options. The handle is integrated into the door front.

Storage with Handles

Laterals

How to order

1. Specify product number.
2. Specify finish color.
3. Specify options.

Product code key example 30-24-P2FFH

- 30** cabinet width
24 interior height
P pencil drawer
2 number of file drawers
FF fixed front
H Storage with Handles

Exterior cabinet heights are nominal. Actual heights (with glides fully recessed) are $\frac{1}{8}$ " less. Hinged doors are standard with self-closing European style hinges that open 110°. Shelves are slotted every 1 $\frac{1}{2}$ " and are height adjustable in 1 $\frac{1}{2}$ " increments.

Cabinets are 18" in depth.

Counterweights

Counterweights are required for ALL freestanding units that are not anchored or ganged to other cabinets or bolted to walls/floor. See [Counterweight matrix](#).

Accessories



See [Lateral File Accessories](#) section for counterweights and accessories.

Lock option

Cabinets come standard with lock. If lock is not required add suffix '/NL' after product number. Deduct \$57 list.

Finishes

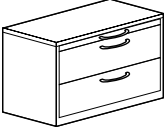
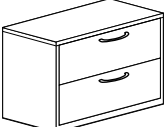
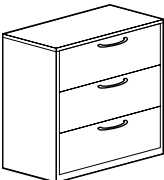
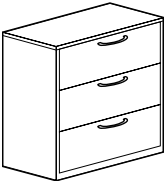
Refer to [Finishes section](#) for color options. Drawer bodies and accessories are finished in Eco Black.

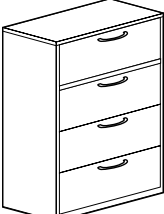
Description	Part number	Height	Depth	Weight (lbs)	Neutral paint/ base price	Accent paint
 <p>2 high cabinet top opening 3" drawer, other 2 openings 10.5" fixed front drawers Counterweight is recommended</p>	30-24-P2FFH	26 $\frac{7}{8}$ "	30"	100	\$1294	+\$132
	36-24-P2FFH	26 $\frac{7}{8}$ "	36"	120	\$1414	+\$143
	42-24-P2FFH	26 $\frac{7}{8}$ "	42"	130	\$1533	+\$156
 <p>2 high cabinet 2-12" fixed front drawers Counterweight is recommended</p>	30-2FFH	26 $\frac{7}{8}$ "	30"	100	\$1083	+\$110
	36-2FFH	26 $\frac{7}{8}$ "	36"	120	\$1188	+\$121
	42-2FFH	26 $\frac{7}{8}$ "	42"	130	\$1302	+\$132
 <p>3 high cabinet 3-10.5 fixed front drawers</p>	30-31.5-3FFH	34 $\frac{3}{8}$ "	30"	120	\$1450	+\$146
	36-31.5-3FFH	34 $\frac{3}{8}$ "	36"	140	\$1598	+\$164
	42-31.5-3FFH	34 $\frac{3}{8}$ "	42"	160	\$1789	+\$181
 <p>3 high cabinet 3-12" fixed front drawers</p>	30-3FFH	38 $\frac{7}{8}$ "	30"	130	\$1456	+\$146
	36-3FFH	38 $\frac{7}{8}$ "	36"	150	\$1611	+\$165
	42-3FFH	38 $\frac{7}{8}$ "	42"	170	\$1812	+\$183
 <p>4 high cabinet 4-10.5" fixed front drawers</p>	30-42-4FFH	44 $\frac{7}{8}$ "	30"	140	\$1789	+\$181
	36-42-4FFH	44 $\frac{7}{8}$ "	36"	160	\$2037	+\$206
	42-42-4FFH	44 $\frac{7}{8}$ "	42"	180	\$2310	+\$234
 <p>4 high cabinet 4-12" fixed front drawers, 1.5" tie bar</p>	30-4FFH	52 $\frac{3}{8}$ "	30"	170	\$1806	+\$183
	36-4FFH	52 $\frac{3}{8}$ "	36"	195	\$2085	+\$211
	42-4FFH	52 $\frac{3}{8}$ "	42"	230	\$2373	+\$240

Storage with Handles

How to order

1. Specify product number.
2. Specify finish color.
3. Specify options.

Product code key example 30-52.5-5FFH

- 30** cabinet width
52.5 interior height
5 number of drawers
FF fixed front
H Storage with Handles

Exterior cabinet heights are nominal. Actual heights (with glides fully recessed) are $\frac{1}{8}$ " less. Hinged doors are standard with self-closing European style hinges that open 110°. Shelves are slotted every 1½" and are height adjustable in 1½" increments.

Cabinets are 18" in depth.

Counterweights

Counterweights are required for ALL freestanding units that are not anchored or ganged to other cabinets or bolted to walls/floor. See [Counterweight matrix](#).

Accessories

See [Lateral File Accessories](#) section for counterweights and accessories.

Lock option

Cabinets come standard with lock. If lock is not required add suffix '/NL' after product number. Deduct \$57 list.

Finishes

Refer to [Finishes section](#) for color options. Drawer bodies and accessories are finished in Eco Black.

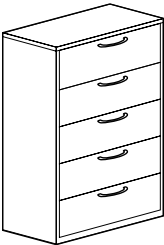
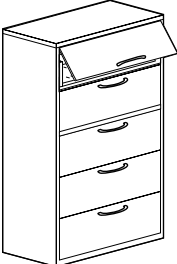
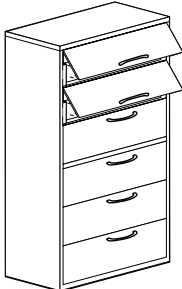
	Description	Part number	Height	Depth	Weight (lbs)	Neutral paint/ base price	Accent paint
	5 high cabinet	30-52.5-5FFH	55 $\frac{3}{8}$ "	30"	180	\$2129	+\$214
	5-10.5" fixed front drawers	36-52.5-5FFH	55 $\frac{3}{8}$ "	36"	205	\$2434	+\$247
		42-52.5-5FFH	55 $\frac{3}{8}$ "	42"	240	\$2770	+\$279
	5 high cabinet	30-5FFH	64 $\frac{3}{8}$ "	30"	200	\$2151	+\$216
	top opening 12" lift-up with pullout shelf, other 4 openings 12" fixed front drawers, 1.5" tie bar	36-5FFH	64 $\frac{3}{8}$ "	36"	235	\$2461	+\$249
		42-5FFH	64 $\frac{3}{8}$ "	42"	265	\$2798	+\$282
	6 high cabinet	30-6FFH	76 $\frac{3}{8}$ "	30"	250	\$2619	+\$265
	top opening 12" lift-up with fixed shelf and 3 plate dividers, next opening 12" lift-up with pullout shelf and hangfile bars, other 4 openings 12" fixed front drawers, 1.5" tie bar	36-6FFH	76 $\frac{3}{8}$ "	36"	270	\$2994	+\$302
		42-6FFH	76 $\frac{3}{8}$ "	42"	291	\$3374	+\$340

Storage with Handles

How to order

1. Specify product number.
2. Specify finish color.
3. Specify options.

Product code key example 3036HDH-SH

30	cabinet width
36	interior height
HD	hinged door
H	Storage with Handles
SH	shelf

Exterior cabinet heights are nominal. Actual heights (with glides fully recessed) are $\frac{1}{8}$ " less. Hinged doors are standard with self-closing European style hinges that open 110°. Shelves are slotted every 1½" and are height adjustable in ½" increments.

Cabinets are 18" in depth.

Counterweights

Counterweights are required for ALL freestanding units that are not anchored or ganged to other cabinets or bolted to walls/floor. See [Counterweight matrix](#).

Pulls

Overfile and Storage Cabinets do not have pull options. The handle is integrated into the door front.

Accessories

See [Lateral File Accessories](#) section for counterweights and accessories.

Lock option

Cabinets come standard with lock. If lock is not required add suffix '/NL' after product number. Deduct \$57 list.

Finishes

Refer to [Finishes section](#) for color options. Drawer bodies and accessories are finished in Eco Black.

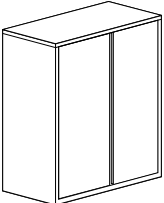
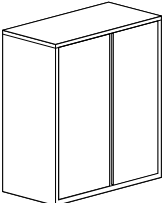
	Description	Part number	Height	Depth	Weight (lbs)	Neutral paint/ base price	Accent paint
	Cabinet with hinged doors, no interior accessories	3024HDH	26 7/8"	30"	75	\$787	+\$83
		3624HDH	26 7/8"	36"	95	\$839	+\$87
		4224HDH	26 7/8"	42"	110	\$893	+\$92
	Cabinet with hinged doors with 1 slotted shelf	3024HDH-SH	26 7/8"	30"	85	\$886	+\$91
		3624HDH-SH	26 7/8"	36"	105	\$945	+\$98
		4224HDH-SH	26 7/8"	42"	115	\$998	+\$102
	Cabinet with hinged doors, no interior accessories	3036HDH	38 7/8"	30"	130	\$922	+\$96
		3636HDH	38 7/8"	36"	140	\$1018	+\$104
		4236HDH	38 7/8"	42"	150	\$1118	+\$114
	Cabinet with hinged doors with 2 slotted shelves	3036HDH-SH	38 7/8"	30"	145	\$1124	+\$115
		3636HDH-SH	38 7/8"	36"	155	\$1218	+\$125
		4236HDH-SH	38 7/8"	42"	165	\$1319	+\$134

Custom Profile

US Price List • June 2021



Specify Custom Profile pedestals without fronts and design your own using a variety of materials. The design ideas are limitless. For fabrication details, refer to the [shop drawings](#) at the end of this section.

ANSI/BIFMA

With the addition of counterweights where appropriate, Custom Profile pedestals meet all ANSI/BIFMA specifications.

Construction

Pedestals are welded, “wrap-around” construction using 20 gauge high quality, tension leveled, cold rolled steel. The steel gauges selected for drawer fronts, bodies and accessories ensure the highest quality durability and performance for all components.

Construction features & benefits

1. “Wrap-around” construction with no visible vertical seams gives a clean appearance.
2. Completely enclosed case provides rigid construction and dust-free interiors.
3. Box drawer sides are slotted on 1” centers to allow for maximum flexibility for drawer division.
4. Box drawer side double-wall construction provides clean appearance and enclosed divider slots.
5. File (12” drawer bodies have full-height sides to accommodate hanging file folders, eliminating the need for optional file frames.
6. Fully-progressive ball bearing suspensions on all drawers, including pencil and box drawers, are staged so that left and right sides work in unison. This provides smooth drawer operation with minimum force.
7. Staged suspensions allow the drawer to be completely pulled out, providing access to the entire drawer depth.
8. Special “claw-like” device incorporated in the suspension “grips” the fixed section of the suspension arm preventing drawer bounce-back or creep when drawer is closed.
9. Casters and glides are both recessed “inboard” for a uniform exterior appearance with no visible hardware.
10. Modular interior allows for complete interchangeability of drawer types within the pedestal case. For example, two 6” box drawers may be replaced by one 12” file drawer.

Counterweights

Counterweights are required for ALL freestanding units that are not anchored or ganged to other cabinets or bolted to walls/floor.

Counterweights come standard with ALL mobile pedestals and must be field installed.

Drawer standard equipment

3” pencil drawer, 6” box drawer and 12” file drawer are standard.

Pedestals containing 3” or 6” drawers have the option to order one pencil tray per pedestal. 6” drawers have the additional option to order one steel divider.

10½” and 12” letter-width file drawers have the option to order suspension bar (two in a 28” deep pedestal) for side-to-side filing of legal or letter-size folders.

Bases

Optional base aprons are available in 2 heights and are screwed to the underside of the pedestal case. Bases may be easily added or changed on site. Pedestals are shipped with bases installed when ordered.

Casters

4 swivel, recessed 1⅝” black, double-wheel phenolic carpet casters are supplied with mobile pedestals and must be field installed. Recessed casters are not visible.

Glides

Overall heights are inclusive of metal glides or casters. Heights may be increased up to ⅝” by extending standard glide. Glides are accessible from inside the pedestal when the bottom drawer is fully extended or removed and may be adjusted with a ¼” socket driver.

Optional 1½” stem glides are available. Specify separately and add \$30 list to the pedestal price. Requires field installation.

Locks

Pedestals come standard with lock. If lock is not required add suffix ‘/NL’ after product number. Deduct \$71 list per lock. For lock location, see diagrams at the front of this price list. **Extended lock barrels are standard.** For flush, non-fascia type locks, specify separately. Mobile pedestals must include locks.

Random keying is standard. Pedestals may be ordered keyed alike. Specify. Locks feature removable core and are standard with two keys, one of which has a black neoprene plastic key cover.

Cabinets originally ordered as non-locking may be field installed with the addition of locking bars and a lock core. Please contact Office Specialty Client Services for required parts.

Master keys are available at \$51 list. Locks are available in Chrome and Black finish. Specify.

Finishes

Refer to [Finishes section](#) for color options.

How to order

1. Specify product number.
2. Specify finish color.
3. Specify options.

Product code key example 1522C-2BFM

- 15** pedestal width
22 pedestal depth
C Custom Profile Series
2 number of drawers
B box drawer
F file drawer
M mobile

Pedestals are standard with either glides or casters. Exterior pedestal heights are nominal. Actual heights (with glides fully recessed) are $\frac{1}{8}$ " less. Casters must be field installed.

Counterweights

Counterweights are required for ALL freestanding units that are not anchored or ganged to other cabinets or bolted to walls/floor. Counterweights are standard with all mobile pedestals and must be field installed. See [Counterweight matrix](#).

See [Pedestal Accessories](#) section for counterweight codes and pricing.

Lock option

Pedestals come standard with lock. If lock is not required add suffix **'/NL'** after product number. Deduct \$71 list. **Extended lock barrels are standard.**

Finishes

Refer to [Finishes section](#) for color options. Drawer bodies and accessories are finished in Eco Black.

Cushions

Order mobile pedestal cushions as a 'part' through your Client Services Representative.

Optional Accessories

All pedestal accessories are optional. See chart below for information on accessories by drawer height.

Drawer Height	Product Code	Product Description	Price
3" & 4.5"	WS-PTxx	Pencil Tray	\$37
6" & 7.5"	WS-PTxx	Pencil Tray	\$37
	WS-DVxx	Divider	\$22
18"D, 22"D, 28"D Pedestals Only (28"D requires 2 per drawer)			
10.5", 12", 13.5, & 15"	SSFxx	Side-To-Side Filing Bar	\$8

Visit the [Pedestal Accessories](#) section for full accessory details.

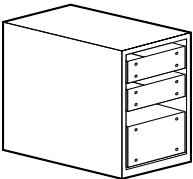
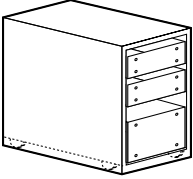
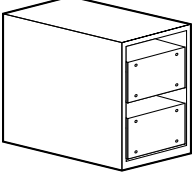
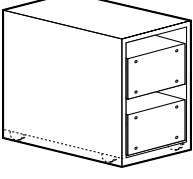
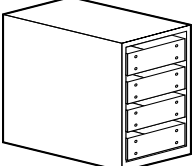
Description	Part number	Height	Depth	Weight (lbs)	Neutral point/ base price	Accent paint
 2 box, 1 file, glides	1518C-2BF	26 $\frac{7}{8}$ "	18"	70	\$908	+\$93
	1522C-2BF	26 $\frac{7}{8}$ "	22"	80	\$1011	+\$103
	1528C-2BF	26 $\frac{7}{8}$ "	28"	90	\$1052	+\$107
 2 box, 1 file, mobile, counterweight included Mobile pedestals must be locking	1518C-2BFM	27 $\frac{1}{2}$ "	18"	75	\$1095	+\$111
	1522C-2BFM	27 $\frac{1}{2}$ "	22"	85	\$1200	+\$123
	1528C-2BFM	27 $\frac{1}{2}$ "	28"	95	\$1237	+\$127
 2 file, glides	1518C-2F	26 $\frac{7}{8}$ "	18"	70	\$835	+\$87
	1522C-2F	26 $\frac{7}{8}$ "	22"	80	\$923	+\$96
	1528C-2F	26 $\frac{7}{8}$ "	28"	90	\$964	+\$99
 2 file, mobile, counterweight included Mobile pedestals must be locking	1518C-2FM	27 $\frac{1}{2}$ "	18"	75	\$1022	+\$104
	1522C-2FM	27 $\frac{1}{2}$ "	22"	85	\$1111	+\$114
	1528C-2FM	27 $\frac{1}{2}$ "	28"	95	\$1150	+\$118
 4 box, glides	1518C-4B	26 $\frac{7}{8}$ "	18"	70	\$908	+\$93
	1522C-4B	26 $\frac{7}{8}$ "	22"	80	\$1011	+\$103
	1528C-4B	26 $\frac{7}{8}$ "	28"	90	\$1052	+\$107

How to order

1. Specify product number.
2. Specify finish color.
3. Specify options.

Product code key example 1522C-PBFM

- 15** pedestal width
22 pedestal depth
C Custom Profile Series
P pencil drawer
B box drawers
F file drawer
M mobile

Pedestals are standard with either glides or casters. Exterior pedestal heights are nominal. Actual heights (with glides fully recessed) are $\frac{1}{8}$ " less. Casters must be field installed.

Counterweights

Counterweights are required for ALL freestanding units that are not anchored or ganged to other cabinets or bolted to walls/floor. Counterweights are standard with all mobile pedestals and must be field installed. See [Counterweight matrix](#).

See [Pedestal Accessories](#) section for counterweight codes and pricing.

Lock option

Pedestals come standard with lock. If lock is not required add suffix **'/NL'** after product number. Deduct \$71 list. **Extended lock barrels are standard.**

Finishes

Refer to [Finishes section](#) for color options. Drawer bodies and accessories are finished in Eco Black.

Cushions

Order mobile pedestal cushions as a 'part' through your Client Services Representative.

Optional Accessories

All pedestal accessories are optional. See chart below for information on accessories by drawer height.

Drawer Height	Product Code	Product Description	Price
3" & 4.5"	WS-PTxx	Pencil Tray	\$37
6" & 7.5"	WS-PTxx	Pencil Tray	\$37
	WS-DVxx	Divider	\$22
18"D, 22"D, 28"D Pedestals Only (28"D requires 2 per drawer)			
10.5", 12", 13.5, & 15"	SSFxx	Side-To-Side Filing Bar	\$8

Visit the [Pedestal Accessories](#) section for full accessory details.

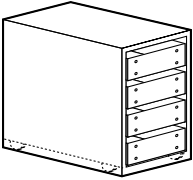
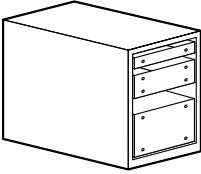
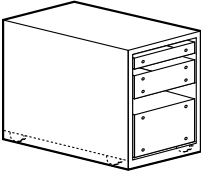
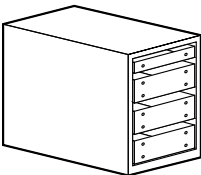
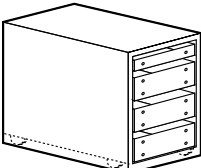
	Description	Part number	Height	Depth	Weight (lbs)	Neutral point/ base price	Accent paint
	4 box, mobile, counterweight included Mobile pedestals must be locking	1518C-4BM	27 1/2"	18"	75	\$1095	+\$111
		1522C-4BM	27 1/2"	22"	85	\$1200	+\$123
		1528C-4BM	27 1/2"	28"	95	\$1237	+\$127
	1 pencil, 1 box, 1 file, glides	1518C-PBF	23 7/8"	18"	65	\$908	+\$93
		1522C-PBF	23 7/8"	22"	75	\$1011	+\$103
		1528C-PBF	23 7/8"	28"	85	\$1052	+\$107
	1 pencil, 1 box, 1 file, mobile, counterweight included Mobile pedestals must be locking	1518C-PBFM	24 1/2"	18"	70	\$1095	+\$111
		1522C-PBFM	24 1/2"	22"	80	\$1200	+\$123
		1528C-PBFM	24 1/2"	28"	90	\$1237	+\$127
	1 pencil, 3 box, glides	1518C-P3B	23 7/8"	18"	65	\$908	+\$93
		1522C-P3B	23 7/8"	22"	75	\$1011	+\$103
		1528C-P3B	23 7/8"	28"	85	\$1052	+\$107
	1 pencil, 3 box, mobile, counterweight included Mobile pedestals must be locking	1518C-P3BM	24 1/2"	18"	70	\$1095	+\$111
		1522C-P3BM	24 1/2"	22"	80	\$1200	+\$123
		1528C-P3BM	24 1/2"	28"	90	\$1237	+\$127

Specify Custom Profile lateral or hinged door cabinets without fronts and design your own using a variety of materials. The design ideas are limitless. For fabrication details, refer to the [shop drawings](#) at the end of this section.

ANSI/BIFMA

With the addition of counterweights where appropriate, Custom Profile lateral files meet all ANSI/BIFMA specifications.

Construction

Lateral files and hinged door cabinets are of all-welded construction using 20 and 22 gauge high quality, tension leveled, cold rolled steel. The steel gauges selected for drawer fronts, bodies and accessories ensure the highest quality durability and performance for all components.

Construction features & benefits

1. All interiors are modular and interchangeable so that cabinets can be retrofitted with new accessories and interiors.
2. Corners are strengthened with a reinforcing gusset and are welded at junction of top and case, eliminating horizontal lines for a cleaner, flush appearance on the face of the cabinet.
3. Fully-progressive ball bearing suspensions are staged so that left and right sides work in unison. This provides smooth drawer operation with minimum force.
4. Special "claw-like" device incorporated in suspensions "grips" the fixed section of the suspension arm preventing drawer bounce-back or creep when drawer is closed.
5. Lock bars operate vertically on both sides of the cabinet for maximum security.
6. Lock fingers are configured with right angle bend upward, not downward, so that lift-up doors cannot be pulled down to disengage fingers from door slots and be forced to circumvent lock system.
7. Self-closing, 110° opening, European style cupboard hinges provide smooth hinged door operation. Hinges are not visible from the exterior of the cabinet.

Safelock™

The patented Safelock mechanism provides complete security against accidental opening of two or more drawers simultaneously. When any drawer or shelf is extended, even fractionally, Safelock ensures that all other openings, except for the 3" drawer, immediately become inoperable. Safelock is standard on all lateral files.

Counterweights

Counterweights are required for ALL freestanding units that are not anchored or ganged to other cabinets or bolted to walls/floor.

Drawer standard equipment

Pullout drawers are standard with one pair hangfile bars for side-to-side suspended filing. Optional accessories are available.

Bases

Optional base aprons are available in 2 heights and are screwed to the underside of the cabinet. Bases may be easily added or changed on site. Cabinets are shipped with bases installed with ordered.

Glides

Overall heights are inclusive of metal glides. Heights may be increased up to 5/8" by extending standard glide. Standard glides may be used with or without base aprons. Glides are accessible from inside the cabinet when the bottom drawer is fully extended or removed and may be adjusted with a 1/4" socket driver.

Optional 1 1/2" stem glides are available. Specify separately and add \$30 list to the cabinet price. Requires field installation.

Locks

Cabinets come standard with lock. If lock is not required add suffix '/NL' after product number. Deduct \$71 list per lock. For lock location, see the front of this price list. **Extended lock barrels are standard.** For flush, non-fascia type locks, specify separately.

Random keying is standard. Files may be ordered keyed alike. Specify. Locks feature removable core and are standard with two keys, one of which features a black neoprene plastic cover.

Cabinets originally ordered as non-locking may be field installed with the addition of locking bars and a lock core. Please contact Office Specialty Client Services for required parts. Locks may not be field installed in hinged door cabinets.

Master keys are available at \$51 list. For lock finish options, refer to the front of this price list.

Finishes

Refer to [Finishes section](#) at the front of this price list.

Case height matrix

Interior height		Exterior height	
in.	mm	in.	mm
15"	381	17 7/8"	454
16 1/2"	419	19 3/8"	492
18"	457	20 7/8"	530
19 1/2"	495	22 3/8"	568
21"	533	23 7/8"	606
22 1/2"	572	25 3/8"	645
24"	610	26 7/8"	683
25 1/2"	648	28 3/8"	721
27"	686	29 7/8"	759
28 1/2"	724	31 3/8"	797
30"	762	32 7/8"	835
31 1/2"	800	34 3/8"	873
33"	838	35 7/8"	911
34 1/2"	876	37 3/8"	949
36"	914	38 7/8"	987
37 1/2"	953	40 3/8"	1026
39"	991	41 7/8"	1064
40 1/2"	1029	43 3/8"	1102
42"	1067	44 7/8"	1140
43 1/2"	1105	46 3/8"	1178
45"	1143	47 7/8"	1216
46 1/2"	1181	49 3/8"	1254
48"	1219	50 7/8"	1292
49 1/2"	1257	52 3/8"	1330
51"	1295	53 7/8"	1368
52 1/2"	1334	55 3/8"	1407
54"	1372	56 7/8"	1445
55 1/2"	1410	58 3/8"	1483
57"	1448	59 7/8"	1521
58 1/2"	1486	61 3/8"	1559
60"	1524	62 7/8"	1597
61 1/2"	1562	64 3/8"	1635
63"	1600	65 7/8"	1673
64 1/2"	1638	67 3/8"	1711
66"	1676	68 7/8"	1749
67 1/2"	1715	70 3/8"	1788
69"	1753	71 7/8"	1826
70 1/2"	1791	73 3/8"	1864
72"	1829	74 7/8"	1902
73 1/2"	1867	76 3/8"	1940
75"	1905	77 7/8"	1978
76 1/2"	1943	79 3/8"	2016

Custom Profile

Laterals
Letter/Legal Size Media

How to order

1. Specify product number.
2. Specify finish color.
3. Specify options.

Product code key example 36-24-2BFC

36	cabinet width
24	interior height
2	number of drawers
B	6" box drawer
F	12" file drawer
C	Custom Profile Series

These cabinets are complete assembled units without drawer or door fronts. Prices do not include fronts. See the shop drawings at the end of this section for information about the fabrication and installation of custom fronts. Exterior cabinet heights are nominal. Actual heights (with glides fully recessed) are $\frac{1}{8}$ " less. Cabinets are priced inclusive of 1 pair of hangfile bars in each pullout opening, 1 EDP kit in each 15" opening.

Cabinets are 18" in depth.

Counterweights

Counterweights are required for ALL freestanding units that are not anchored or ganged to other cabinets or bolted to walls/floor. Counterweights are standard with all mobile pedestals and must be field installed. See [Counterweight matrix](#).

Accessories

See [Lateral File Accessories](#) section for counterweights and accessories.

Lock option

Cabinets come standard with lock. If lock is not required add suffix '/NL' after product number. Deduct \$71 list. **Extended lock barrels are standard.**

Finishes

Refer to [Finishes section](#) for color options. Drawer bodies and accessories are finished in Eco Black.

Description	Part number	Height	Depth	Weight (lbs)	Neutral paint/ base price	Accent paint
 Cabinet with 2-12" drawers, no fronts	30-2FFC	26 $\frac{7}{8}$ "	30"	72	\$1047	+\$106
	36-2FFC	26 $\frac{7}{8}$ "	36"	90	\$1143	+\$118
	42-2FFC	26 $\frac{7}{8}$ "	42"	108	\$1257	+\$128
 Cabinet with top 2 openings 6" drawers, bottom opening 12" drawer, no fronts	30-24-2BFC	26 $\frac{7}{8}$ "	30"	72	\$1174	+\$120
	36-24-2BFC	26 $\frac{7}{8}$ "	36"	90	\$1292	+\$131
	42-24-2BFC	26 $\frac{7}{8}$ "	42"	108	\$1422	+\$143
 Cabinet with 2-15" drawers, no fronts	30-30-2EDPC	32 $\frac{7}{8}$ "	30"	76	\$1285	+\$131
	36-30-2EDPC	32 $\frac{7}{8}$ "	36"	94	\$1366	+\$139
	42-30-2EDPC	32 $\frac{7}{8}$ "	42"	112	\$1510	+\$153
 Cabinet with 3-12" drawers, no fronts	30-3FFC	38 $\frac{7}{8}$ "	30"	100	\$1395	+\$141
	36-3FFC	38 $\frac{7}{8}$ "	36"	117	\$1534	+\$156
	42-3FFC	38 $\frac{7}{8}$ "	42"	134	\$1720	+\$174
 Cabinet with top 2 openings 6" drawers, bottom 2 openings 12" drawers, no fronts	30-36-2B2FC	38 $\frac{7}{8}$ "	30"	100	\$1523	+\$154
	36-36-2B2FC	38 $\frac{7}{8}$ "	36"	117	\$1685	+\$171
	42-36-2B2FC	38 $\frac{7}{8}$ "	42"	134	\$1886	+\$191

Custom Profile

How to order

1. Specify product number.
2. Specify finish color.
3. Specify options.

Product code key example 36-24-3EDPC

- 36** cabinet width
24 interior height
3 number of drawers
EDP EDP kit
C Custom Profile Series

These cabinets are complete assembled units without drawer or door fronts. Prices do not include fronts. See the shop drawings at the end of this section for information about the fabrication and installation of custom fronts. Exterior cabinet heights are nominal. Actual heights (with glides fully recessed) are $\frac{1}{8}$ " less. Cabinets are priced inclusive of 1 pair of hangfile bars in each pullout opening, 1 EDP kit in each 15" opening.

Cabinets are 18" in depth.

Counterweights

Counterweights are required for ALL freestanding units that are not anchored or ganged to other cabinets or bolted to walls/floor. Counterweights are standard with all mobile pedestals and must be field installed. See [Counterweight matrix](#).

Accessories

See [Lateral File Accessories](#) section for counterweights and accessories.

Lock option

Cabinets come standard with lock. If lock is not required add suffix '/NL' after product number. Deduct \$71 list. **Extended lock barrels are standard.**

Finishes

Refer to [Finishes section](#) for color options. Drawer bodies and accessories are finished in Eco Black.

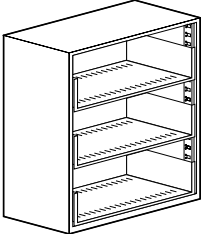
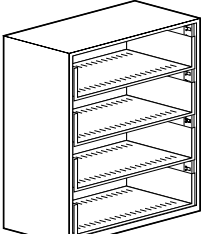
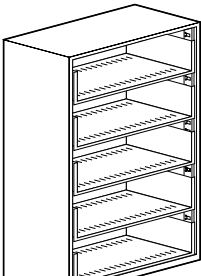
Description	Part number	Height	Depth	Weight (lbs)	Neutral paint/ base price	Accent paint
 Cabinet with 3-15" drawers, no fronts	30-45-3EDPC	47 $\frac{7}{8}$ "	30"	104	\$1673	+\$170
	36-45-3EDPC	47 $\frac{7}{8}$ "	36"	121	\$1889	+\$192
	42-45-3EDPC	47 $\frac{7}{8}$ "	42"	138	\$2122	+\$214
 Cabinet with 4-12" drawers, no fronts	30-4FFC	50 $\frac{7}{8}$ "	30"	130	\$1697	+\$172
	36-4FFC	50 $\frac{7}{8}$ "	36"	146	\$1978	+\$200
	42-4FFC	50 $\frac{7}{8}$ "	42"	162	\$2243	+\$226
 Cabinet with 4-15" drawers, no fronts	30-60-4EDPC	62 $\frac{7}{8}$ "	30"	134	\$2070	+\$209
	36-60-4EDPC	62 $\frac{7}{8}$ "	36"	150	\$2289	+\$231
	42-60-4EDPC	62 $\frac{7}{8}$ "	42"	166	\$2564	+\$259
 Cabinet with 5-12" drawers, no fronts	30-5FFC	62 $\frac{7}{8}$ "	30"	134	\$2013	+\$204
	36-5FFC	62 $\frac{7}{8}$ "	36"	150	\$2301	+\$233
	42-5FFC	62 $\frac{7}{8}$ "	42"	166	\$2614	+\$264

Custom Profile

Laterals
Multi-units

How to order

1. Specify product number.
2. Specify finish color.
3. Specify options.

Product code key example 36-48-2BFC

- 36** cabinet width
48 interior height
2 number of drawers
B 6" box drawer
F 12" file drawer
C Custom Profile Series

These cabinets are complete assembled units without drawer or door fronts. Prices do not include fronts. See the shop drawings at the end of this section for information about the fabrication and installation of custom fronts. Exterior cabinet heights are nominal. Actual heights (with glides fully recessed) are $\frac{1}{8}$ " less. Cabinets are priced inclusive of 1 pair of hangfile bars in each pullout opening, 1 EDP kit in each 15" opening.

Cabinets are 18" in depth.

Counterweights

Counterweights are required for ALL freestanding units that are not anchored or ganged to other cabinets or bolted to walls/floor. Counterweights are standard with all mobile pedestals and must be field installed. See [Counterweight matrix](#).

Accessories

See [Lateral File Accessories](#) section for counterweights and accessories.

Lock option

Cabinets come standard with lock. If lock is not required add suffix '/NL' after product number. Deduct \$71 list. **Extended lock barrels are standard.**

Finishes

Refer to [Finishes section](#) for color options. Drawer bodies and accessories are finished in Eco Black.

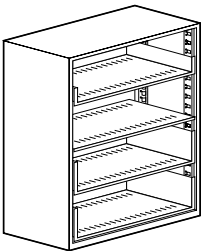
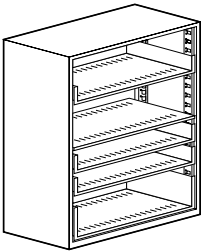
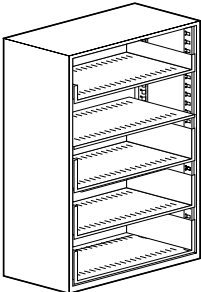
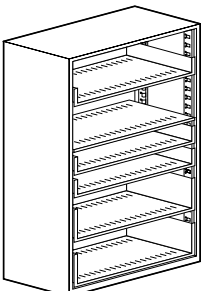
Description	Part number	Height	Depth	Weight (lbs)	Neutral paint/ base price	Accent paint
 <p>Cabinet with top opening 24" cupboard insert, other 2 openings 12" drawers, no doors or fronts</p>	30-48-HD2FC	50 $\frac{7}{8}$ "	30"	58	\$1690	+\$172
	36-48-HD2FC	50 $\frac{7}{8}$ "	36"	70	\$1933	+\$196
	42-48-HD2FC	50 $\frac{7}{8}$ "	42"	82	\$2173	+\$219
 <p>Cabinet with top opening 24" cupboard insert, next 2 openings 6" drawers, bottom opening 12" drawer, no doors or fronts</p>	30-48-HD2BFC	50 $\frac{7}{8}$ "	30"	61	\$1819	+\$184
	36-48-HD2BFC	50 $\frac{7}{8}$ "	36"	73	\$2082	+\$210
	42-48-HD2BFC	50 $\frac{7}{8}$ "	42"	85	\$2341	+\$237
 <p>Cabinet with top opening 24" cupboard insert, other 3 openings 12", drawers, no doors or fronts</p>	30-60-HD3FC	62 $\frac{7}{8}$ "	30"	71	\$2003	+\$204
	36-60-HD3FC	62 $\frac{7}{8}$ "	36"	91	\$2259	+\$227
	42-60-HD3FC	62 $\frac{7}{8}$ "	42"	101	\$2543	+\$256
 <p>Cabinet with top opening 24" cupboard insert, next 2 openings 6" drawers, bottom 2 openings 12" drawers, no doors or fronts</p>	30-60-HD2B2FC	62 $\frac{7}{8}$ "	30"	74	\$2131	+\$215
	36-60-HD2B2FC	62 $\frac{7}{8}$ "	36"	94	\$2407	+\$243
	42-60-HD2B2FC	62 $\frac{7}{8}$ "	42"	104	\$2709	+\$274

Custom Profile

How to order

1. Specify product number.
2. Specify finish color.
3. Specify options.

Product code key example 3624HDC-SH

- 36** cabinet width
24 interior height
HD hinged doors
C Custom Profile Series
SH shelf

These cabinets are complete assembled units without door fronts. Prices do not include fronts. See the shop drawings at the end of this section for information about the fabrication and installation of custom fronts. Exterior cabinet heights are nominal. Actual heights (with glides fully recessed) are $\frac{1}{8}$ " less. Standard hardware is self-closing European style hinges that open 110°. Shelves are slotted every 1½" and are height adjustable in ½" increments. Shelf dividers are not included.

Cabinets are 18" in depth.

Accessories

See [Lateral File Accessories](#) section for counterweights and accessories.

Lock option

Cabinets come standard with lock. If lock is not required add suffix '**NL**' after product number. Deduct \$71 list. **Extended lock barrels are standard.**

Finishes

Refer to [Finishes section](#) for color options. Drawer bodies and accessories are finished in Eco Black.

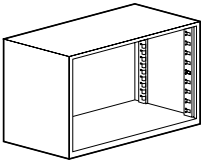
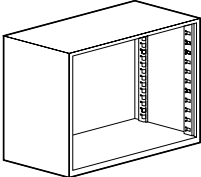
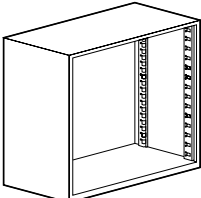
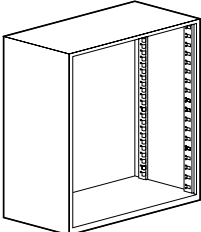
Description	Part number	Height	Depth	Weight (lbs)	Neutral paint/ base price	Accent paint
	3024HDC	26 7/8"	30"	38	\$708	+\$72
	3624HDC	26 7/8"	36"	46	\$738	+\$76
	4224HDC	26 7/8"	42"	54	\$785	+\$83
Cabinet with 1 slotted shelf, no doors	3024HDC-SH	26 7/8"	30"	48	\$807	+\$85
	3624HDC-SH	26 7/8"	36"	57	\$837	+\$87
	4224HDC-SH	26 7/8"	42"	66	\$882	+\$91
	3030HDC	32 7/8"	30"	43	\$781	+\$81
	3630HDC	32 7/8"	36"	52	\$812	+\$85
	4230HDC	32 7/8"	42"	61	\$896	+\$92
Cabinet with 1 slotted shelf, no doors	3030HDC-SH	32 7/8"	30"	53	\$876	+\$91
	3630HDC-SH	32 7/8"	36"	63	\$910	+\$94
	4230HDC-SH	32 7/8"	42"	73	\$991	+\$102
	3036HDC	38 7/8"	30"	48	\$793	+\$83
	3636HDC	38 7/8"	36"	58	\$843	+\$88
	4236HDC	38 7/8"	42"	68	\$924	+\$96
Cabinet with 2 slotted shelves, no doors	3036HDC-SH	38 7/8"	30"	58	\$989	+\$101
	3636HDC-SH	38 7/8"	36"	68	\$1041	+\$106
	4236HDC-SH	38 7/8"	42"	78	\$1124	+\$115
	3045HDC	47 7/8"	30"	56	\$1014	+\$103
	3645HDC	47 7/8"	36"	68	\$1058	+\$107
	4245HDC	47 7/8"	42"	80	\$1198	+\$123
Cabinet with 2 slotted shelves, no doors	3045HDC-SH	47 7/8"	30"	86	\$1220	+\$125
	3645HDC-SH	47 7/8"	36"	99	\$1257	+\$128
	4245HDC-SH	47 7/8"	42"	112	\$1393	+\$141

Custom Profile

How to order

1. Specify product number.
2. Specify finish color.
3. Specify options.

Product code key example 3648HDC-SH

- 36** cabinet width
48 interior height
HD hinged door
C Custom Profile Series
SH shelf

These cabinets are complete assembled units without door fronts. Prices do not include fronts. See the shop drawings at the end of this section for information about the fabrication and installation of custom fronts. Exterior cabinet heights are nominal. Actual heights (with glides fully recessed) are $\frac{1}{8}$ " less. Standard hardware is self-closing European style hinges that open 110°. Shelves are slotted every 1½" and are height adjustable in 1½" increments. Shelf dividers are not included.

Cabinets are 18" in depth.

Accessories

See [Lateral File Accessories](#) section for counterweights and accessories.

Lock option

Cabinets come standard with lock. If lock is not required add suffix '/NL' after product number. Deduct \$71 list. **Extended lock barrels are standard.**

Finishes

Refer to [Finishes section](#) for color options. Drawer bodies and accessories are finished in Eco Black.

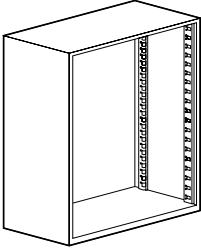
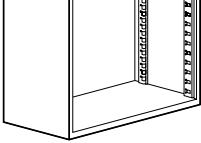
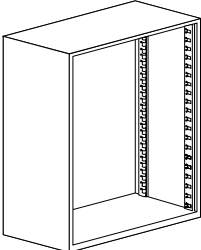
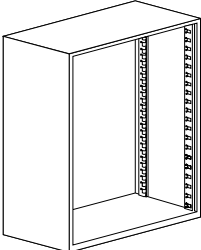
Description	Part number	Height	Depth	Weight (lbs)	Neutral paint/ base price	Accent paint
 Cabinet with no interior accessories, no doors	3048HDC	50 7/8"	30"	58	\$922	+\$96
	3648HDC	50 7/8"	36"	70	\$1062	+\$108
	4248HDC	50 7/8"	42"	82	\$1200	+\$123
 Cabinet with 2 slotted shelves, no doors	3048HDC-SH	50 7/8"	30"	88	\$1120	+\$115
	3648HDC-SH	50 7/8"	36"	103	\$1259	+\$129
	4248HDC-SH	50 7/8"	42"	118	\$1395	+\$141
 Cabinet with no interior accessories, no doors	3049.5HDC	52 3/8"	30"	59	\$939	+\$97
	3649.5HDC	52 3/8"	36"	71	\$1063	+\$108
	4249.5HDC	52 3/8"	42"	83	\$1201	+\$124
 Cabinet with 2 slotted shelves, no doors	3049.5HDC-SH	52 3/8"	30"	89	\$1137	+\$116
	3649.5HDC-SH	52 3/8"	36"	104	\$1260	+\$129
	4249.5HDC-SH	52 3/8"	42"	119	\$1396	+\$141

How to order

1. Specify product number.
2. Specify finish color.
3. Specify options.

Product code key example 3660HDC-WS

- 36** cabinet width
60 interior height
HD hinged doors
C Custom Profile Series
WS shelves with coat rod

These cabinets are complete assembled units without door fronts. Prices do not include fronts. See the shop drawings at the end of this section for information about the fabrication and installation of custom fronts. Exterior cabinet heights are nominal. Actual heights (with glides fully recessed) are $\frac{1}{8}$ " less. Standard hardware is self-closing European style hinges that open 110°. Shelves are slotted every $1\frac{1}{2}$ " and are height adjustable in $1\frac{1}{2}$ " increments. Shelf dividers are not included.

Cabinets are 18" in depth.

Accessories

See [Lateral File Accessories](#) section for counterweights and accessories.

Lock option

Cabinets come standard with lock. If lock is not required add suffix '**NL**' after product number. Deduct \$71 list. **Extended lock barrels are standard.**

Finishes

Refer to [Finishes section](#) for color options. Drawer bodies and accessories are finished in Eco Black.

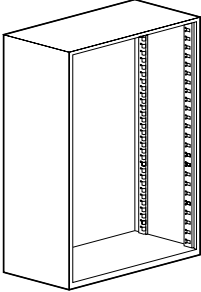
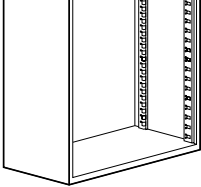
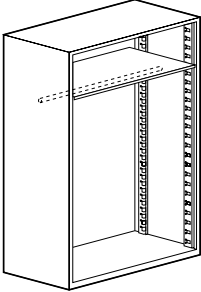
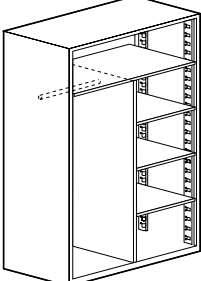
Description	Part number	Height	Depth	Weight (lbs)	Neutral paint/ base price	Accent paint
 <p>Cabinet with no interior accessories, no doors</p>	3060HDC	62 $\frac{7}{8}$ "	30"	68	\$904	+\$93
	3660HDC	62 $\frac{7}{8}$ "	36"	82	\$1032	+\$105
	4260HDC	62 $\frac{7}{8}$ "	42"	96	\$1177	+\$120
 <p>Cabinet with 3 slotted shelves, no doors</p>	3060HDC-SH	62 $\frac{7}{8}$ "	30"	98	\$1200	+\$123
	3660HDC-SH	62 $\frac{7}{8}$ "	36"	115	\$1328	+\$134
	4260HDC-SH	62 $\frac{7}{8}$ "	42"	132	\$1474	+\$148
 <p>Cabinet with 1 blank shelf and side-to-side coat rod, no doors</p>	3060HDC-W	62 $\frac{7}{8}$ "	30"	78	\$1037	+\$105
	3660HDC-W	62 $\frac{7}{8}$ "	36"	95	\$1167	+\$120
	4260HDC-W	62 $\frac{7}{8}$ "	42"	112	\$1314	+\$133
 <p>Cabinet with 1 full width blank shelf, 3 half width shelves and 1 half width coat rod, no doors</p>	3060HDC-WS	62 $\frac{7}{8}$ "	30"	88	\$1266	+\$129
	3660HDC-WS	62 $\frac{7}{8}$ "	36"	105	\$1394	+\$141
	4260HDC-WS	62 $\frac{7}{8}$ "	42"	122	\$1542	+\$157

Custom Profile

How to order

1. Specify product number.
2. Specify finish color.
3. Specify options.

Product code key example

3673.5HDC

- 36** cabinet width
73.5 interior height
HD hinged doors
C Custom Profile Series
SH shelves

These cabinets are complete assembled units without door fronts. Prices do not include fronts. See the shop drawings at the end of this section for information about the fabrication and installation of custom fronts. Exterior cabinet heights are nominal. Actual heights (with glides fully recessed) are $\frac{1}{8}$ " less. Standard hardware is self-closing European style hinges that open 110°. Shelves are slotted every 1½" and are height adjustable in 1½" increments. Shelf dividers are not included.

Cabinets are 18" in depth.

Accessories

See [Lateral File Accessories](#) section for counterweights and accessories.

Lock option

Cabinets come standard with lock. If lock is not required add suffix '/NL' after product number. Deduct \$71 list. **Extended lock barrels are standard.**

Finishes

Refer to [Finishes section](#) for color options. Drawer bodies and accessories are finished in Eco Black.

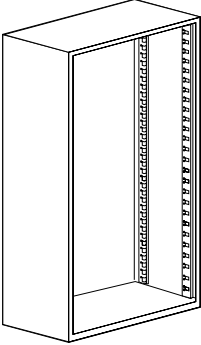
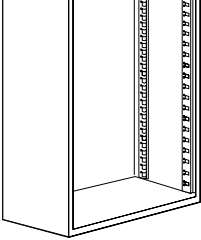
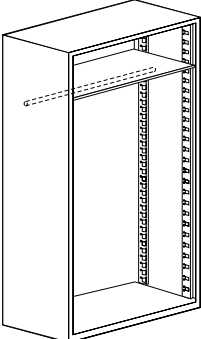
Description	Part number	Height	Depth	Weight (lbs)	Neutral paint/ base price	Accent paint
 Cabinet with no interior accessories, no doors	3073.5HDC	76 $\frac{3}{8}$ "	30"	81	\$1095	+\$111
	3673.5HDC	76 $\frac{3}{8}$ "	36"	92	\$1260	+\$129
	4273.5HDC	76 $\frac{3}{8}$ "	42"	104	\$1414	+\$143
 Cabinet with 4 slotted shelves, no doors	3073.5HDC-SH	76 $\frac{3}{8}$ "	30"	121	\$1490	+\$151
	3673.5HDC-SH	76 $\frac{3}{8}$ "	36"	136	\$1655	+\$169
	4273.5HDC-SH	76 $\frac{3}{8}$ "	42"	152	\$1808	+\$183
 Cabinet with 1 blank shelf and side-to-side coat rod, no doors	3073.5HDC-W	76 $\frac{3}{8}$ "	30"	91	\$1228	+\$126
	3673.5HDC-W	76 $\frac{3}{8}$ "	36"	105	\$1394	+\$141
	4273.5HDC-W	76 $\frac{3}{8}$ "	42"	120	\$1549	+\$159

Custom Profile

Build-Ups Basic Lateral Cabinets

How to order

1. Specify basic cabinet product number.
2. Specify cabinet interiors from TOP to BOTTOM.
3. Specify accessories, see Accessories section.
4. Specify finish color.
5. If lock is not required add suffix '/NL' after product number. Deduct \$71 list.

Product code key example 30-15C

30 cabinet width
15 cabinet interior clear height
C Custom Profile Series

Cases in this section are basic empty units without doors, drawers or accessories. Specify cabinet components and accessories on the following pages ensuring the total height of the selected components equals the total interior clear height of the case. Cabinets are available in 42" case heights and 3" widths. Interior components are available in 3", 6", 10½", 12", 13½", 15" and 24" sizes. (Note: 3" drawers specified in a bottom opening, above a 1½" filler or above a reference shelf cannot be locked.) ¾" glides are standard and can be used with our without base aprons. Counterweights are recommended.

Cabinets are 18" in depth.

Counterweights

Counterweights are required for ALL freestanding units that are not anchored or ganged to other cabinets or bolted to walls/floor. See [Counterweight matrix](#).

Finishes

Refer to [Finishes section](#) for color options.

Note: Exterior cabinet heights shown below are nominal. Actual heights, with glides fully recessed, are ½" less.

Cabinets 64 ¾" and over include a hidden tie bar in their construction.

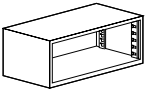
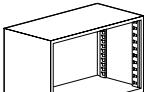
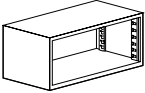
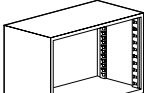
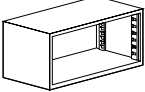
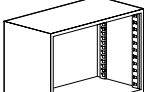
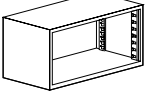
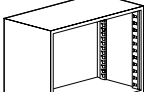
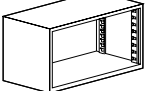
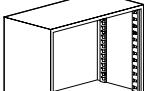
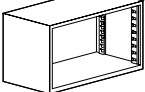
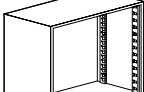
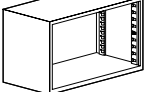
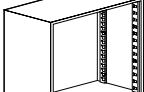
	Interior height	Exterior height	Part number	Neutral paint/ base price	Accent paint		Interior height	Exterior height	Part number	Neutral paint/ base price	Accent paint
	15"	17 7/8"	30-15C 36-15C 42-15C	\$494 \$544 \$582	+\$52 +\$57 +\$60		25 1/2"	28 3/8"	30-25.5C 36-25.5C 42-25.5C	\$571 \$574 \$627	+\$59 +\$60 +\$64
	16 1/2"	19 3/8"	30-16.5C 36-16.5C 42-16.5C	\$511 \$551 \$584	+\$53 +\$58 +\$60		27"	29 7/8"	30-27C 36-27C 42-27C	\$580 \$598 \$661	+\$60 +\$62 +\$67
	18"	20 7/8"	30-18C 36-18C 42-18C	\$515 \$552 \$590	+\$54 +\$58 +\$61		28 1/2"	31 3/8"	30-28.5C 36-28.5C 42-28.5C	\$598 \$617 \$688	+\$62 +\$63 +\$71
	19 1/2"	22 3/8"	30-19.5C 36-19.5C 42-19.5C	\$517 \$553 \$598	+\$54 +\$58 +\$62		30"	32 7/8"	30-30C 36-30C 42-30C	\$599 \$639 \$721	+\$62 +\$65 +\$73
	21"	23 7/8"	30-21C 36-21C 42-21C	\$518 \$555 \$600	+\$54 +\$58 +\$62		31 1/2"	34 3/8"	30-31.5C 36-31.5C 42-31.5C	\$600 \$643 \$722	+\$62 +\$66 +\$73
	22 1/2"	25 3/8"	30-22.5C 36-22.5C 42-22.5C	\$519 \$556 \$601	+\$54 +\$58 +\$62		33"	35 7/8"	30-33C 36-33C 42-33C	\$601 \$646 \$729	+\$62 +\$66 +\$74
	24"	26 7/8"	30-24C 36-24C 42-24C	\$521 \$557 \$603	+\$54 +\$58 +\$62		34 1/2"	37 3/8"	30-34.5C 36-34.5C 42-34.5C	\$603 \$653 \$741	+\$62 +\$66 +\$76

Custom Profile

Build-Ups Basic Lateral Cabinets

How to order

1. Specify basic cabinet product number.
2. Specify cabinet interiors from TOP to BOTTOM.
3. Specify accessories, see Accessories section.
4. Specify finish color.
5. If lock is not required add suffix 'NL' after product number. Deduct \$71 list.

Product code key example 30-36C

- 30** cabinet width
36 cabinet interior clear height
C Custom Profile Series

Cases in this section are basic empty units without doors, drawers or accessories. Specify cabinet components and accessories on the following pages ensuring the total height of the selected components equals the total interior clear height of the case. Cabinets are available in 42" case heights and 3" widths. Interior components are available in 3", 6", 10½", 12", 13½", 15" and 24" sizes. (Note: 3" drawers specified in a bottom opening, above a 1½" filler or above a reference shelf cannot be locked.) ¾" glides are standard and can be used with our without base aprons. Counterweights are recommended.

Cabinets are 18" in depth.

Counterweights

Counterweights are required for ALL freestanding units that are not anchored or ganged to other cabinets or bolted to walls/floor. See [Counterweight matrix](#).

Finishes

Refer to [Finishes section](#) for color options.

Note: Exterior cabinet heights shown below are nominal. Actual heights, with glides fully recessed, are ½" less.

Cabinets 64 ¾" and over include a hidden tie bar in their construction.

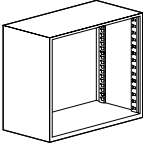
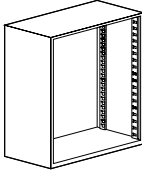
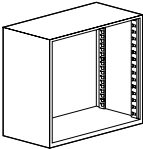
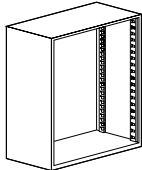
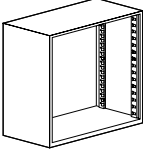
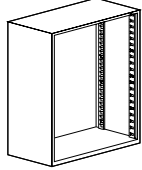
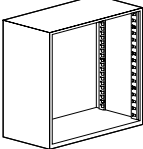
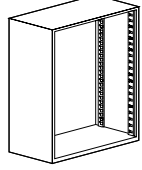
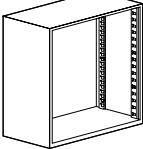
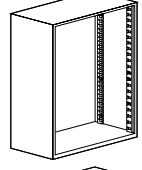
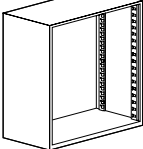
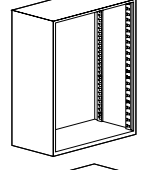
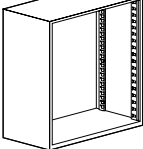
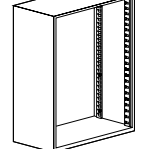
	Interior height	Exterior height	Part number	Neutral paint/ base price	Accent paint		Interior height	Exterior height	Part number	Neutral paint/ base price	Accent paint
	36"	38 ¾"	30-36C 36-36C 42-36C	\$606 \$655 \$741	+\$62 +\$67 +\$76		46 ½"	49 ¾"	30-46.5C 36-46.5C 42-46.5C	\$646 \$801 \$939	+\$66 +\$84 +\$97
	37 ½"	40 ¾"	30-37.5C 36-37.5C 42-37.5C	\$618 \$677 \$775	+\$63 +\$69 +\$81		48"	50 ¾"	30-48C 36-48C 42-48C	\$647 \$802 \$942	+\$66 +\$84 +\$97
	39"	41 ¾"	30-39C 36-39C 42-39C	\$628 \$699 \$801	+\$64 +\$71 +\$84		49 ½"	52 ¾"	30-49.5C 36-49.5C 42-49.5C	\$661 \$805 \$943	+\$67 +\$84 +\$97
	40 ½"	43 ¾"	30-40.5C 36-40.5C 42-40.5C	\$632 \$726 \$837	+\$65 +\$74 +\$87		51"	53 ¾"	30-51C 36-51C 42-51C	\$679 \$809 \$950	+\$70 +\$85 +\$98
	42"	44 ¾"	30-42C 36-42C 42-42C	\$640 \$752 \$871	+\$65 +\$77 +\$90		52 ½"	55 ¾"	30-52.5C 36-52.5C 42-52.5C	\$680 \$813 \$962	+\$70 +\$85 +\$99
	43 ½"	46 ¾"	30-43.5C 36-43.5C 42-43.5C	\$643 \$781 \$908	+\$66 +\$81 +\$93		54"	56 ¾"	30-54C 36-54C 42-54C	\$687 \$820 \$966	+\$70 +\$86 +\$99
	45"	47 ¾"	30-45C 36-45C 42-45C	\$644 \$800 \$938	+\$66 +\$84 +\$97		55 ½"	58 ¾"	30-55.5C 36-55.5C 42-55.5C	\$688 \$827 \$976	+\$71 +\$86 +\$100

Custom Profile

Build-Ups Basic Lateral Cabinets

How to order

1. Specify basic cabinet product number.
2. Specify cabinet interiors from TOP to BOTTOM.
3. Specify accessories, see Accessories section.
4. Specify finish color.
5. If lock is not required add suffix '/NL' after product number. Deduct \$71 list.

Product code key example 30-15C

- 30** cabinet width
15 cabinet interior clear height
C Custom Profile Series

Cases in this section are basic empty units without doors, drawers or accessories. Specify cabinet components and accessories on the following pages ensuring the total height of the selected components equals the total interior clear height of the case. Cabinets are available in 42" case heights and 3" widths. Interior components are available in 3", 6", 10½", 12", 13½", 15" and 24" sizes. (Note: 3" drawers specified in a bottom opening, above a 1½" filler or above a reference shelf cannot be locked.) ¾" glides are standard and can be used with our without base aprons. Counterweights are recommended.

Cabinets are 18" in depth.

Counterweights

Counterweights are required for ALL freestanding units that are not anchored or ganged to other cabinets or bolted to walls/floor. See [Counterweight matrix](#).

Finishes

Refer to [Finishes section](#) for color options.

Note: Exterior cabinet heights shown below are nominal. Actual heights, with glides fully recessed, are ½" less.

Cabinets 64 ¾" and over include a hidden tie bar in their construction.

	Interior height	Exterior height	Part number	Neutral paint/ base price	Accent paint		Interior height	Exterior height	Part number	Neutral paint/ base price	Accent paint
	57"	59 7/8"	30-57C 36-57C 42-57C	\$692 \$834 \$981	+\$71 +\$87 +\$101		67 1/2"	70 3/8"	30-67.5C 36-67.5C 42-67.5C	\$789 \$931 \$1092	+\$83 +\$96 +\$111
	58 1/2"	61 3/8"	30-58.5C 36-58.5C 42-58.5C	\$693 \$835 \$982	+\$71 +\$87 +\$101		69"	71 7/8"	30-69C 36-69C 42-69C	\$808 \$976 \$1120	+\$85 +\$100 +\$115
	60"	62 7/8"	30-60C 36-60C 42-60C	\$698 \$836 \$983	+\$71 +\$87 +\$101		70 1/2"	73 3/8"	30-70.5C 36-70.5C 42-70.5C	\$835 \$1005 \$1154	+\$87 +\$103 +\$118
	61 1/2"	64 3/8"	30-61.5C 36-61.5C 42-61.5C	\$699 \$837 \$984	+\$71 +\$87 +\$101		72"	74 7/8"	30-72C 36-72C 42-72C	\$867 \$1034 \$1179	+\$90 +\$105 +\$121
	63"	65 7/8"	30-63C 36-63C 42-63C	\$719 \$866 \$1008	+\$73 +\$90 +\$103		73 1/2"	76 3/8"	30-73.5C 36-73.5C 42-73.5C	\$889 \$1063 \$1220	+\$92 +\$108 +\$125
	64 1/2"	67 3/8"	30-64.5C 36-64.5C 42-64.5C	\$737 \$889 \$1036	+\$76 +\$92 +\$105		75"	77 7/8"	30-75C 36-75C 42-75C	\$926 \$1098 \$1253	+\$96 +\$112 +\$128
	66"	68 7/8"	30-66C 36-66C 42-66C	\$760 \$920 \$1062	+\$79 +\$94 +\$108		76 1/2"	79 3/8"	30-76.5C 36-76.5C	\$963 \$1133	+\$99 +\$116

How to order

1. Specify basic cabinet product number followed by drawer and shelf interiors with their accessories (see Accessories section) in order from TOP to BOTTOM, indicating which interior is in the top position. Interiors may be specified in almost any combination to make up the TOTAL INTERIOR HEIGHT.
2. Specify finish color

Product Code Key Example

6FFC-36

- 6 -opening size
- FF -drawer, no front
- C -Custom Profile Series
- 30 -width

Drawer and shelf interiors on these pages **do not include accessories.**

Accessories

Refer to [Accessories section](#).

Finishes

Refer to [Finishes section](#) for color options. Accessories, drawer bodies and shelves are finished in Eco Black.

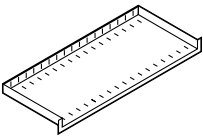
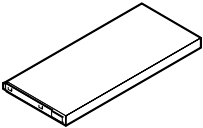
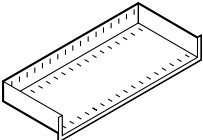
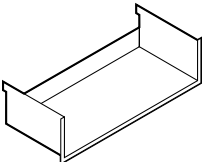
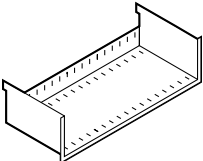
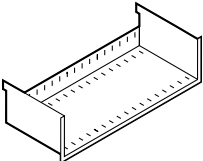
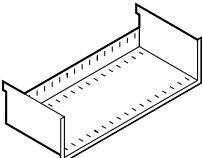
	Description	Part number	Height	Depth	Weight (lbs)	Neutral paint/ base price	Accent paint
	3" Opening Interiors	3FFC-30	3"	30"	6	\$183	+\$21
	3" drawer, no front	3FFC-36	3"	36"	8	\$189	+\$22
		3FFC-42	3"	42"	10	\$199	+\$22
	3" drawer with laminate shelf, no front	3FFC/PL-30	3"	30"	21	\$375	+\$42
		3FFC/PL-36	3"	36"	28	\$389	+\$43
		3FFC/PL-42	3"	42"	35	\$432	+\$46
	6" Opening Interiors	6FFC-30	6"	30"	7	\$199	+\$22
	6" drawer, no front	6FFC-36	6"	36"	9	\$223	+\$25
		6FFC-42	6"	42"	11	\$249	+\$27
	10.5" Opening Interiors	10.5FFC-30	10.5"	30"	10	\$223	+\$25
	10.5" drawer no front to accommodate suspended filing	10.5FFC-36	10.5"	36"	13	\$254	+\$27
	Note: Not to be used for bottom filing. (drawer will not accept dividers)	10.5FFC-42	10.5"	42"	16	\$286	+\$31
	12" Opening Interiors	12FFC-30	12"	30"	11	\$223	+\$25
	12" drawer, no front	12FFC-36	12"	36"	14	\$254	+\$27
		12FFC-42	12"	42"	17	\$286	+\$31
	13.5" Opening Interiors	13.5FFC-30	13.5"	30"	12	\$267	+\$29
	13.5" drawer, no front	13.5FFC-36	13.5"	36"	15	\$288	+\$31
		13.5FFC-42	13.5"	42"	18	\$320	+\$34
	15" Opening Interiors	15FFC-30	15"	30"	12	\$267	+\$29
	15" drawer, no front	15FFC-36	15"	36"	15	\$288	+\$31
		15FFC-42	15"	42"	18	\$320	+\$34

How to order

1. Specify basic cabinet product number followed by drawer and shelf interiors with their accessories (see [Accessories section](#)) in order from TOP to BOTTOM, indicating which interior is in the top position. Interiors may be specified in almost any combination to make up the TOTAL INTERIOR HEIGHT.
2. Specify finish color

Product Code Key Example

25.5SS-36

25.5 opening size
SS SuperStor™
36 width

Drawer and shelf interiors on these pages **do not include accessories.**

Accessories

Refer to [Accessories section](#).

Finishes

Refer to [Finishes section](#) for color options. SuperStor™ insert and trays are finished in Onyx Black (#E013).

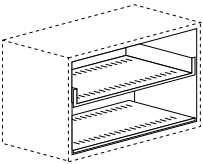
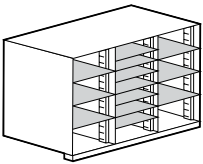
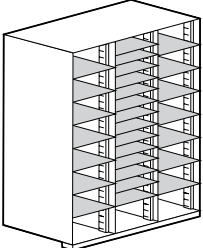
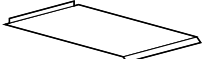
Description	Part number	Height	Depth	Weight (lbs)	Neutral paint/ base price	Accent paint
 <p>24" and 27" Opening Interiors 24" and 27" opening for hinged doors, 1 adjustable slotted shelf. Bottom shelf is standard with slots. Must be specified in top opening.</p>	24HDC/SH-30	24"	30"	20	\$518	+\$54
	24HDC/SH-36	24"	36"	25	\$544	+\$57
	24HDC/SH-42	24"	42"	30	\$582	+\$60
	27HDC/SH-30	27"	30"	22	\$518	+\$70
	27HDC/SH-36	27"	36"	27	\$544	+\$57
	27HDC/SH-42	27"	42"	32	\$582	+\$60
 <p>25.5" Opening Interior 25.5" SuperStor™ insert, contains 3 vertical compartments each with 22 slots at 1" increments. May be installed in cabinets with 36" or more interior. SuperStor™ insert must be specified in the top opening of your build-up. Order trays separately.</p>	25.5SS-36	25.5"	36"	55	\$542	+\$57
 <p>51" Opening Interior 51" SuperStor™ insert with or without hinged doors, contains 3 vertical compartments each with 48" slots at 1" increments. May be installed in cabinets with 58.5" or more interior. SuperStor™ inserts must be specified in the top opening of your build-up. Order trays separately.</p>	51SS-36	51"	36"	110	\$857	+\$89
 <p>SuperStor™ trays Pack of 12 trays, black only</p>	T12SS-BL	—	10"	25	\$268	—

The following page contains technical data that enable the specifier to communicate to local fabricators, critical measurements and other details. This will ensure that custom-fabricated fronts can easily be installed either on-site or elsewhere. Please contact Client Services if additional information is required.

Note: Choose your configuration from the available drawers shown below.

Typical clearances

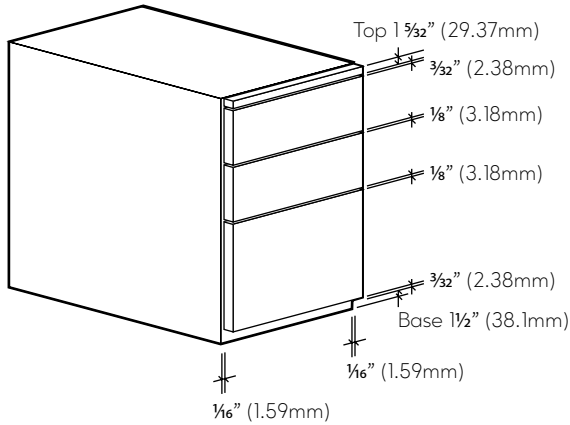

2-6" Box & 1-12" File Drawers shown above.

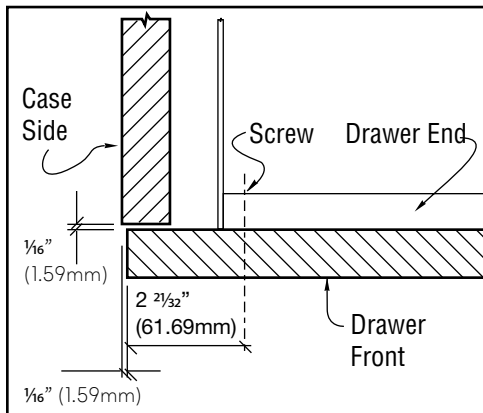

Top View of Drawer Front Mounting Detail

Note to Millwork installers: if a standard extended lock is ordered, it will be shipped with a barrel around the lock cylinder. This should be discarded and the cylinder only fitted through the fascia. Fascia must be $\frac{3}{4}$ " (19.05mm) thick for use with extended lock barrel.

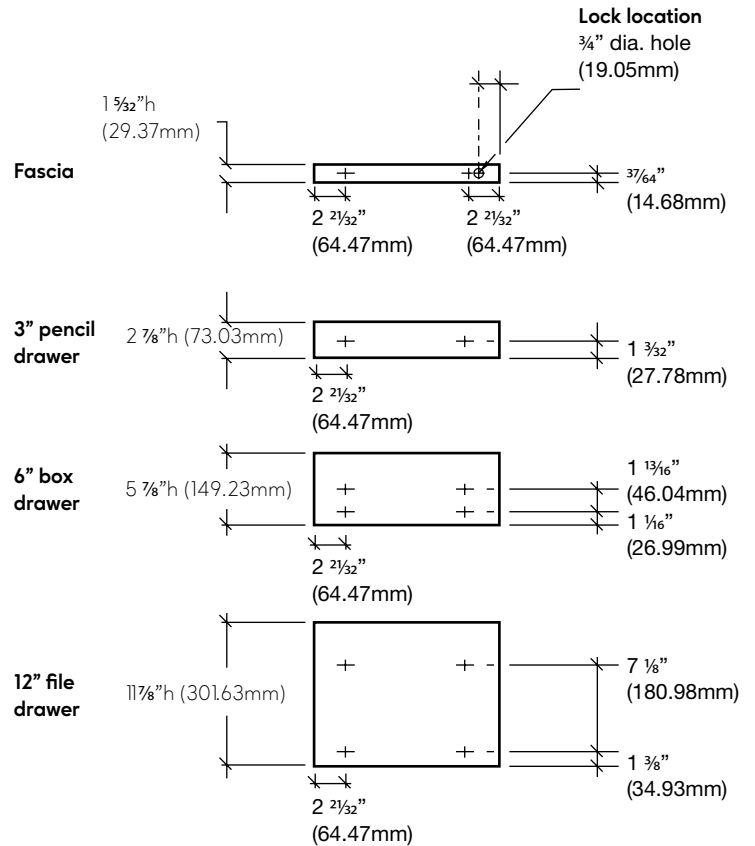

Drawer fronts must be $\frac{3}{4}$ " (19.05mm) thick.

Drawer Front Width

For 15" (381mm) wide pedestals, $14 \frac{7}{8}$ " (377.83mm)
 For 18" (457mm) wide pedestals, $17 \frac{7}{8}$ " (454.03mm)

The following pages contain technical data that enable the specifier to communicate critical measurements and other details to local fabricators. This will ensure that custom-fabricated fronts can easily be installed. Please contact Office Specialty Customer Service if additional information is required.

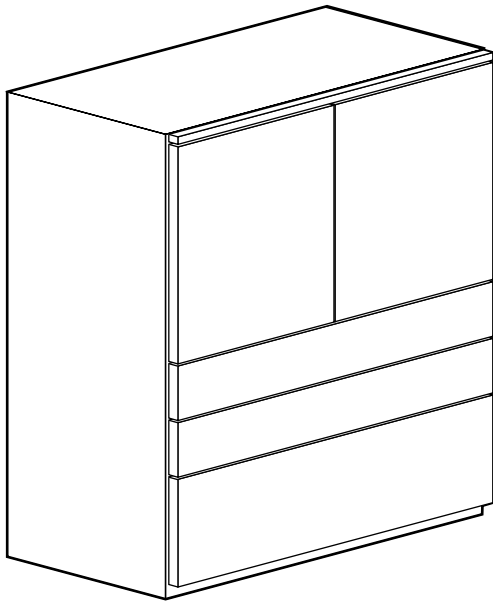

Pilot holes for No. 8 x 5/8" (15 mm) wood screw (3/32" [2 mm] dia. x 5/8" [15 mm]) to mount custom drawer front to drawer body, see detail below.

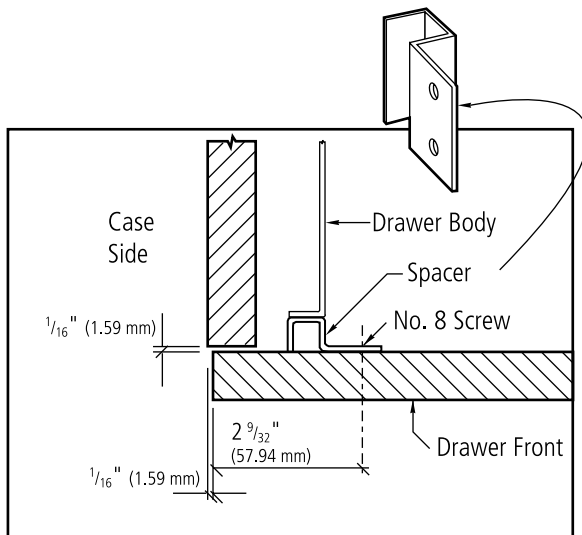

Elevation of interior side of drawer fronts

Fascia (optional) 1 5/32" h (29 mm)

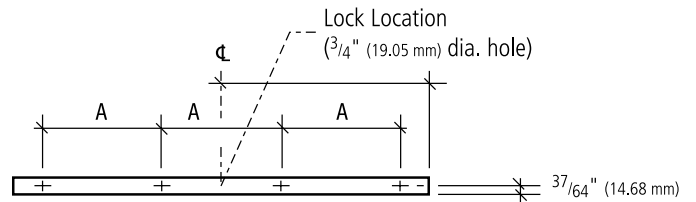

3" (76 mm) Drawer Front - 2 7/8" h. (73.03 mm)

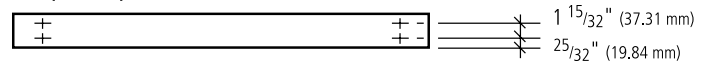

6" (152 mm) Drawer Front - 5 7/8" h. (149.23 mm)

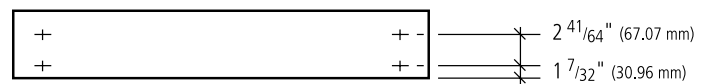

10 1/2" (267 mm) Drawer Front - 10 3/8" h. (263.53 mm)

12" (305 mm) Drawer Front - 11 7/8" h. (301.63 mm)

13 1/2" (343 mm) Drawer Front - 13 3/8" h. (339.73 mm)

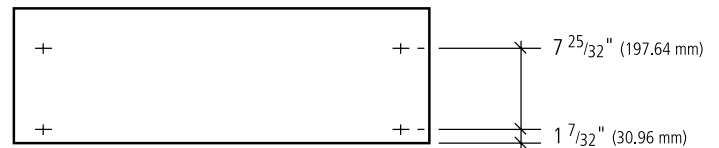

15" (381 mm) Drawer Front 14 7/8" h. (377.83 mm)

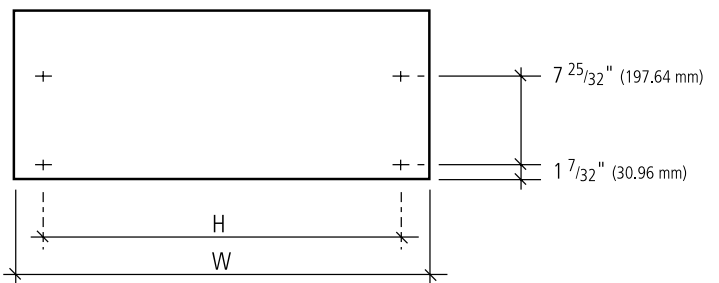

A For 30" (762 mm) wide cabinets is 8 7/16" (214.31 mm)
For 36" (914 mm) wide cabinets is 10 7/16" (265.11 mm)
For 42" (1067 mm) wide cabinets is 12 7/16" (315.91 mm)

H For 30" (762 mm) wide cabinets is 29 5/16" (642.93 mm)
For 36" (914 mm) wide cabinets is 31 5/16" (795.84 mm)
For 42" (1067 mm) wide cabinets is 37 5/16" (947.74 mm)

W For 30" (762 mm) wide cabinets is 29 7/8" (758.83 mm)
For 36" (914 mm) wide cabinets is 35 7/8" (911.23 mm)
For 42" (1067 mm) wide cabinets is 41 7/8" (1063.63 mm)

Drawer fronts 3/4" (19.05 mm) thick

Note: 24" (610 mm), 30" (762 mm), 36" (914 mm) high doors use 2 hinges each

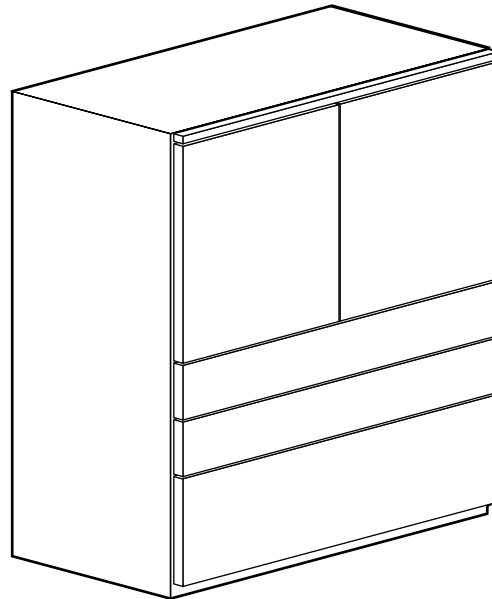

Elevation of interior side of hinged door showing hinge, latch, lock and door striker locations.

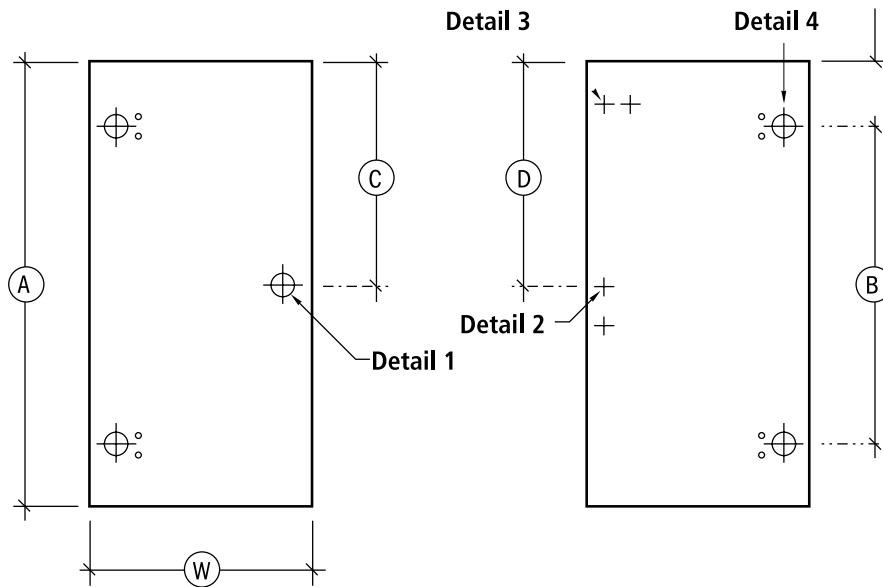

Nominal Door Height	A	B	C	D
24" (610 mm)	23 7/8" (606.43 mm)	15" (381.00 mm)	11 15/16" (303.22 mm)	11 11/16" (296.87 mm)
30" (762 mm)	29 7/8" (758.63 mm)	21" (533.40 mm)	14 15/16" (379.42 mm)	14 11/16" (373.07 mm)
36" (914 mm)	35 7/8" (911.23 mm)	27" (685.80 mm)	17 15/16" (455.62 mm)	17 11/16" (449.27 mm)

W For 30" (762 mm) wide cabinet, each door is 14 7/8" (377.83 mm)
 For 36" (914 mm) wide cabinet, each door is 17 7/8" (454.03 mm)
 For 42" (1067 mm) wide cabinet, each door is 20 7/8" (530.23 mm)

Custom Profile

Note: 45" (1143 mm), 48" (1219 mm), 60" (1524 mm) high doors use 3 hinges each

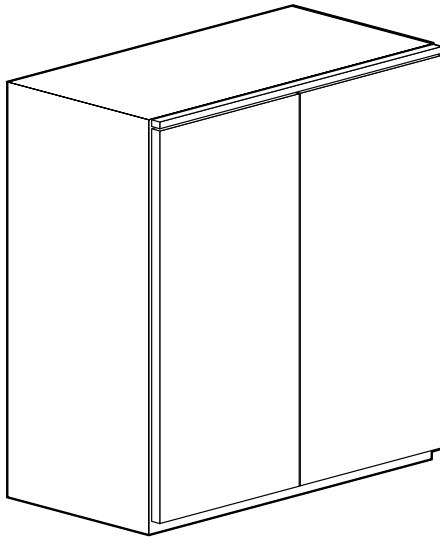

Elevation of interior side of hinged door showing hinge, latch, lock and door striker locations.

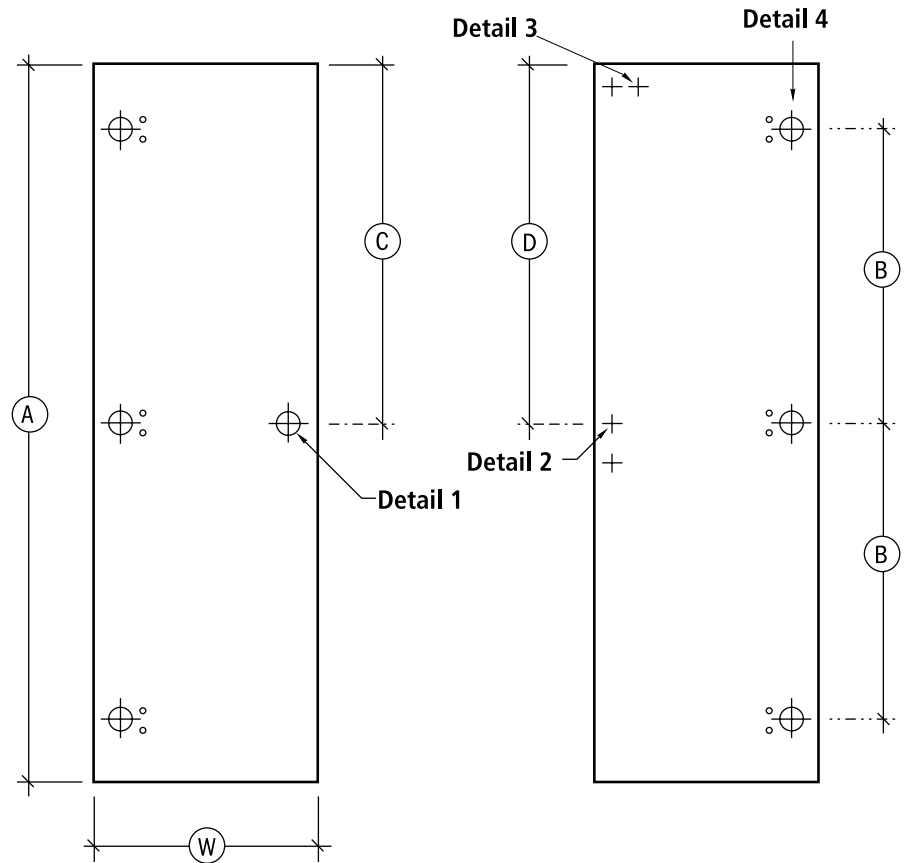

Nominal Door Height	A	B	C	D
45" (1143 mm)	44 ⁷ / ₈ " (1139.83 mm)	18" (457.20 mm)	22 ⁷ / ₁₆ " (569.92 mm)	22 ³ / ₁₆ " (563.56 mm)
48" (1219 mm)	47 ⁷ / ₈ " (1216.03 mm)	19 1/2" (495.30 mm)	23 ¹⁵ / ₁₆ " (608.02 mm)	23 ¹¹ / ₁₆ " (601.67 mm)
60" (1524 mm)	59 ⁷ / ₈ " (1520.83 mm)	25 1/2" (647.70 mm)	29 ¹⁵ / ₁₆ " (760.42 mm)	29 ¹¹ / ₁₆ " (754.07 mm)

W For 30" (762 mm) wide cabinet, each door is 14 ⁷/₈" (377.83 mm)
 For 36" (914 mm) wide cabinet, each door is 17 ⁷/₈" (454.03 mm)
 For 42" (1067 mm) wide cabinet, each door is 20 ⁷/₈" (530.23 mm)

Drilling Details

Door Lock Hole

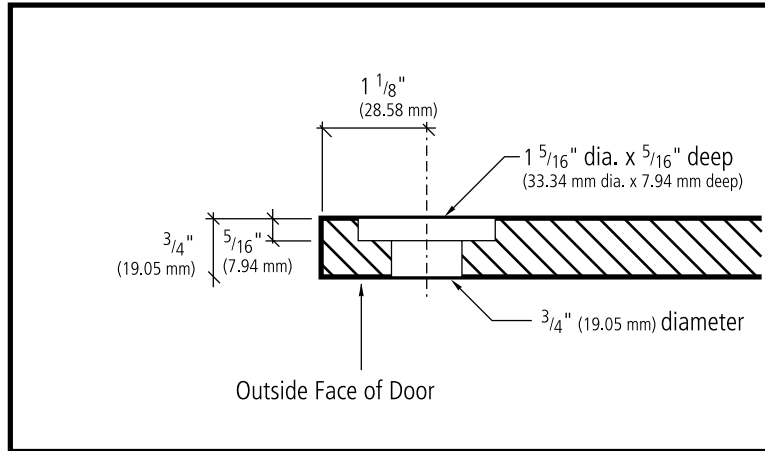

Door Striker Location

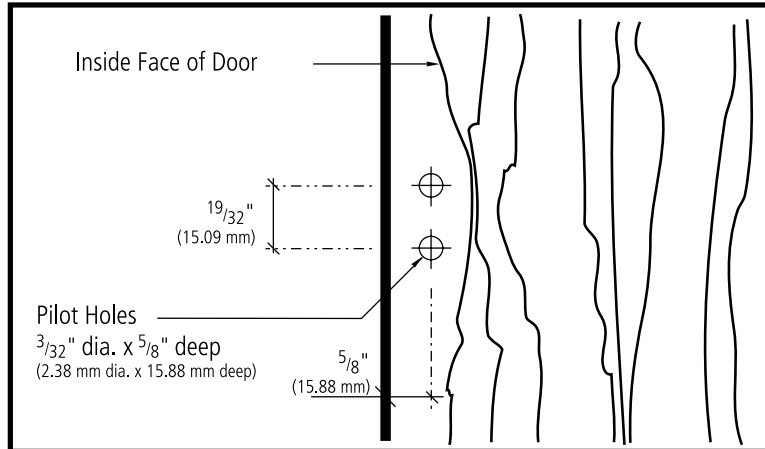

Door Latch Location

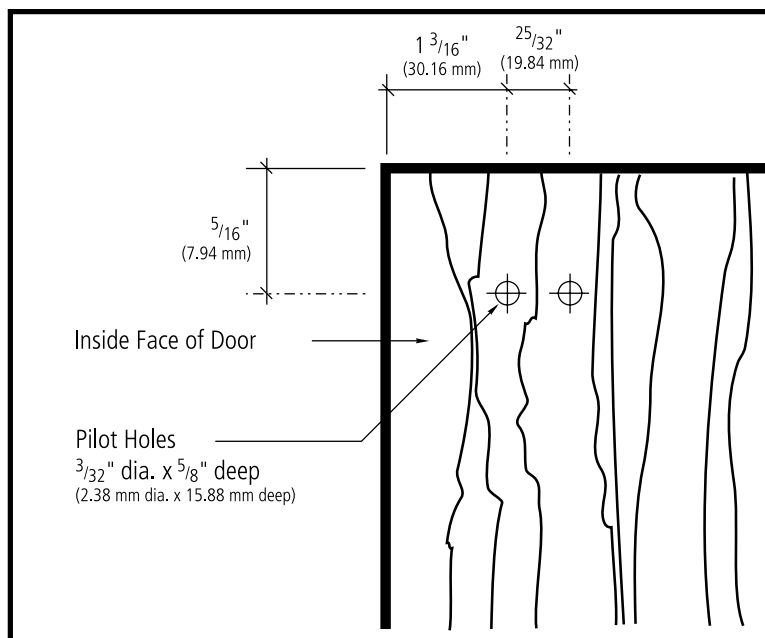

Drilling Details

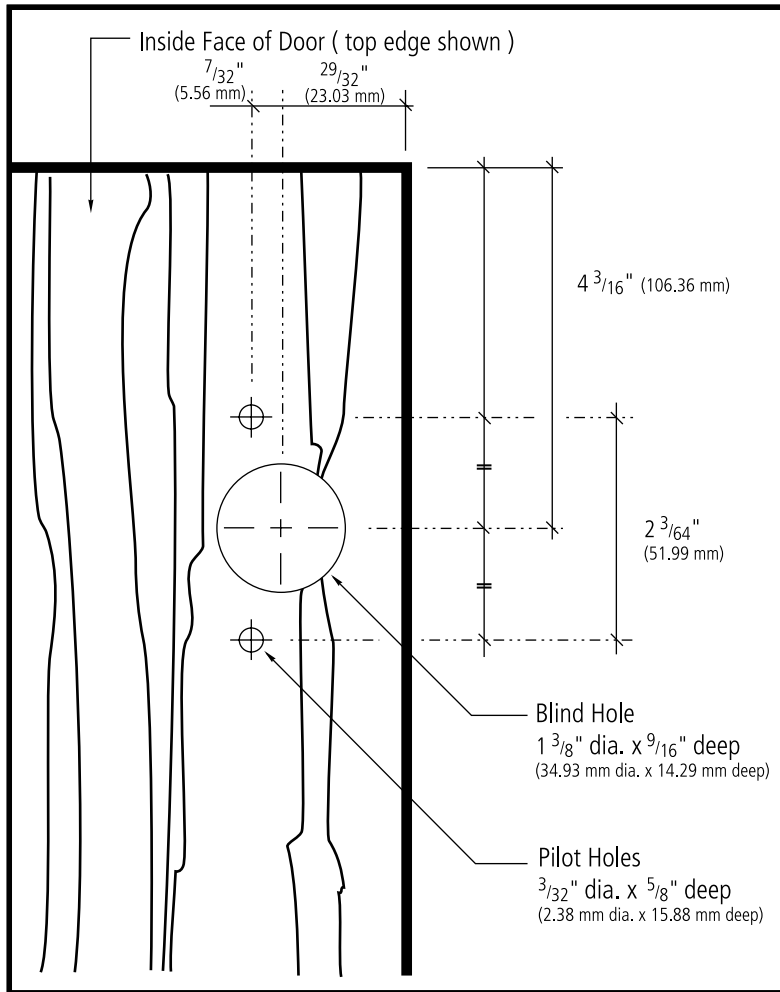

Hinge Mounting Hole



Nuform Shapes

US Price List • June 2021

Nuform Shapes

Nuform Shapes offer a refreshing take on traditional storage. Nuform shapes can be used in a boardroom, private office or even a co-working space, wherever storage is needed. Closed storage is essential for the workplace for both personal items and office supplies.

ANSI/BIFMA

With the addition of counterweights where appropriate, Nuform Shapes meet all ANSI/BIFMA specifications.

Construction

Nuform Shapes hinged door cabinets are of all-welded construction using 20 and 22 gauge high quality, tension leveled, cold rolled steel. The steel gauges selected for drawer bodies and accessories ensure the highest quality durability and performance for all components.

Construction features & benefits

1. All interiors are modular and interchangeable so that cabinets can be retrofitted with new accessories and interior
2. Corners are strengthened with a reinforcing gusset and are welded at junction of top and case, eliminating horizontal lines for a cleaner, flush appearance on the face of the cabinet
3. Self-closing, 110° opening, European style cupboard hinges provide smooth hinged door operation. Hinges are not visible from the exterior of the cabinet.
4. Inset handle, provides a comfortable and ergonomic choice
5. Nuform door fronts provide a seamless edge with a clean aesthetic eliminating the need for an edge banding where bacteria, fungus and mold can penetrate and flourish

Counterweights

Counterweights are required for ALL freestanding units that are not anchored or ganged to other cabinets or bolted to walls/floor.

Glides

Overall heights are inclusive of metal glides. Heights may be increased up to $\frac{3}{8}$ " by extending standard glide. Standard glides may be used with or without base aprons. Glides are accessible from inside the cabinet when the bottom drawer is fully extended or removed and may be adjusted with a $\frac{1}{4}$ " socket driver.

Optional $\frac{1}{2}$ " stem glides are available. Specify separately and add \$30 list to the cabinet price. Requires field installation. For optional Platform glide, see [Accessories section](#) of this price list.

Locks

Nuform Shapes cabinets are not available with locks.

Tops

Refer to [Accessories section](#) to specify matching tops.

Finishes

Refer to the [Finishes section](#) at the front of this price list.

Front Styles

Available in 3 front styles:

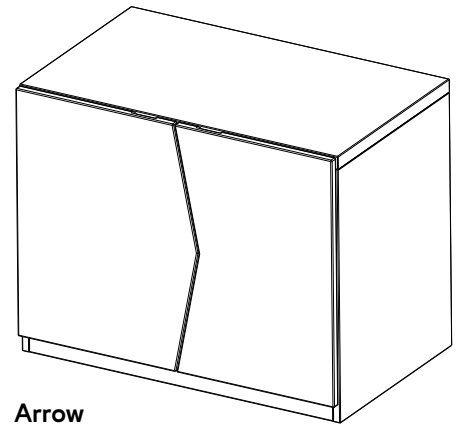

Arrow

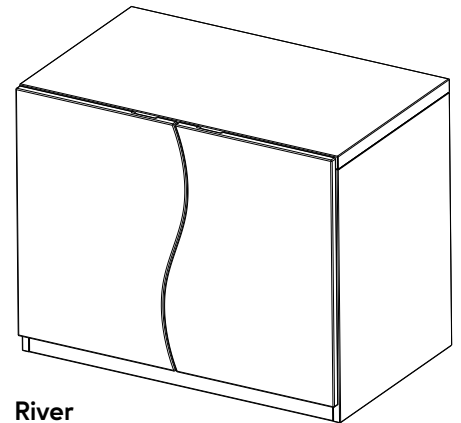

River

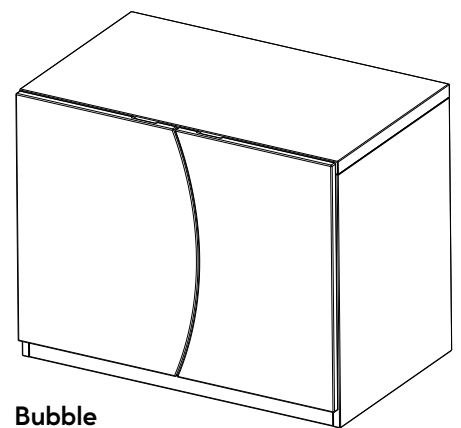

Bubble

Nuform Shapes

Arrow Shape

How to order

1. Specify product number.
2. Specify case finish.
3. Specify front finish.
4. Specify options.

Product code key example

QSAHD3021-SH

- Q** Nuform
- S** Shapes
- A** Arrow shape
- HD** hinged door fronts
- 30** cabinet width
- 21** cabinet interior height
- SH** shelf

Shapes refer to the opening cut in the hinged doors. Exterior cabinet heights are nominal. Actual heights (with glides fully recessed) are $\frac{1}{8}$ " less. Shelves are adjustable. All shelves are slotted to accept dividers. Shelf dividers are not included. See [Accessories section](#).

Pulls



Nuform Shapes come standard with inset handle pull at the top of each hinged door.

Lock option

Cabinets come standard without lock. Locking is NOT an option.

Finishes

Available in Office Specialty's standard finishes. Refer to [Finishes section](#) for finish options for case and fronts. Drawer bodies and accessories are finished in Eco Black.

Description	Part number	Exterior Height	Width	Depth	Nuform Classic/ Neutral paint	Nuform Select/ Neutral paint	Accent paint
 Arrow Shape Hinged Door Cabinet, no interior accessories	QSAHD3021	23 $\frac{7}{8}$ "	30"	18"	\$1097	+\$123	+\$111
	QSAHD3621	23 $\frac{7}{8}$ "	36"	18"	\$1130	+\$126	+\$115
	QSAHD4221	23 $\frac{7}{8}$ "	42"	18"	\$1168	+\$130	+\$118
 Arrow Shape Hinged Door Cabinet with 1 slotted shelf	QSAHD3021-SH	23 $\frac{7}{8}$ "	30"	18"	\$1179	+\$131	+\$119
	QSAHD3621-SH	23 $\frac{7}{8}$ "	36"	18"	\$1217	+\$135	+\$124
	QSAHD4221-SH	23 $\frac{7}{8}$ "	42"	18"	\$1260	+\$140	+\$128
 Arrow Shape Hinged Door Cabinet, no interior accessories	QSAHD3024	26 $\frac{7}{8}$ "	30"	18"	\$1141	+\$127	+\$116
	QSAHD3624	26 $\frac{7}{8}$ "	36"	18"	\$1174	+\$131	+\$119
	QSAHD4224	26 $\frac{7}{8}$ "	42"	18"	\$1212	+\$134	+\$123
 Arrow Shape Hinged Door Cabinet with 1 slotted shelf	QSAHD3024-SH	26 $\frac{7}{8}$ "	30"	18"	\$1223	+\$135	+\$124
	QSAHD3624-SH	26 $\frac{7}{8}$ "	36"	18"	\$1261	+\$140	+\$128
	QSAHD4224-SH	26 $\frac{7}{8}$ "	42"	18"	\$1305	+\$144	+\$132
 Arrow Shape Hinged Door Cabinet, no interior accessories	QSAHD3036	38 $\frac{7}{8}$ "	30"	18"	\$1248	+\$139	+\$127
	QSAHD3636	38 $\frac{7}{8}$ "	36"	18"	\$1289	+\$143	+\$130
	QSAHD4236	38 $\frac{7}{8}$ "	42"	18"	\$1335	+\$147	+\$134
 Arrow Shape Hinged Door Cabinet with 1 slotted shelf	QSAHD3036-SH	38 $\frac{7}{8}$ "	30"	18"	\$1331	+\$147	+\$134
	QSAHD3636-SH	38 $\frac{7}{8}$ "	36"	18"	\$1377	+\$154	+\$139
	QSAHD4236-SH	38 $\frac{7}{8}$ "	42"	18"	\$1427	+\$159	+\$144

Nuform Shapes

River Shape

How to order

1. Specify product number.
2. Specify case finish.
3. Specify front finish.
4. Specify options.

Product code key example

QSBHD3021-SH

- Q** Nuform
- S** Shapes
- B** River shape
- HD** hinged door fronts
- 30** cabinet width
- 21** cabinet interior height
- SH** shelf

Shapes refer to the opening cut in the hinged doors. Exterior cabinet heights are nominal. Actual heights (with glides fully recessed) are 1/8" less. Shelves are adjustable. All shelves are slotted to accept dividers. Shelf dividers are not included. See [Accessories section](#).

Pulls



Nuform Shapes come standard with inset handle pull at the top of each hinged door.

Lock option

Cabinets come standard without lock. Locking is NOT an option.

Finishes

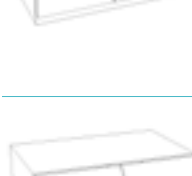
Available in Office Specialty's standard finishes. Refer to [Finishes section](#) for finish options for case and fronts. Drawer bodies and accessories are finished in Eco Black.

Description	Part number	Exterior Height	Width	Depth	Nuform Classic/ Neutral paint	Nuform Select/ Neutral paint	Accent paint
 River Shape Hinged Door Cabinet, no interior accessories	QSBHD3021	23 7/8"	30"	18"	\$1097	+\$123	+\$111
	QSBHD3621	23 7/8"	36"	18"	\$1130	+\$126	+\$115
	QSBHD4221	23 7/8"	42"	18"	\$1168	+\$130	+\$118
 River Shape Hinged Door Cabinet with 1 slotted shelf	QSBHD3021-SH	23 7/8"	30"	18"	\$1179	+\$131	+\$119
	QSBHD3621-SH	23 7/8"	36"	18"	\$1217	+\$135	+\$124
	QSBHD4221-SH	23 7/8"	42"	18"	\$1260	+\$140	+\$128
 River Shape Hinged Door Cabinet, no interior accessories	QSBHD3024	26 7/8"	30"	18"	\$1141	+\$127	+\$116
	QSBHD3624	26 7/8"	36"	18"	\$1174	+\$131	+\$119
	QSBHD4224	26 7/8"	42"	18"	\$1212	+\$134	+\$123
 River Shape Hinged Door Cabinet with 1 slotted shelf	QSBHD3024-SH	26 7/8"	30"	18"	\$1223	+\$135	+\$124
	QSBHD3624-SH	26 7/8"	36"	18"	\$1261	+\$140	+\$128
	QSBHD4224-SH	26 7/8"	42"	18"	\$1305	+\$144	+\$132
 River Shape Hinged Door Cabinet, no interior accessories	QSBHD3036	38 7/8"	30"	18"	\$1248	+\$139	+\$127
	QSBHD3636	38 7/8"	36"	18"	\$1289	+\$143	+\$130
	QSBHD4236	38 7/8"	42"	18"	\$1335	+\$147	+\$134
 River Shape Hinged Door Cabinet with 1 slotted shelf	QSBHD3036-SH	38 7/8"	30"	18"	\$1331	+\$147	+\$134
	QSBHD3636-SH	38 7/8"	36"	18"	\$1377	+\$154	+\$139
	QSBHD4236-SH	38 7/8"	42"	18"	\$1427	+\$159	+\$144

Nuform Shapes

Bubble Shape

How to order

1. Specify product number.
2. Specify case finish.
3. Specify front finish.
4. Specify options.

Product code key example

QSCHD3021-SH

- Q** Nuform
- S** Shapes
- C** Bubble shape
- HD** hinged door fronts
- 30** cabinet width
- 21** cabinet interior height
- SH** shelf

Shapes refer to the opening cut in the hinged doors. Exterior cabinet heights are nominal. Actual heights (with glides fully recessed) are $\frac{1}{8}$ " less. Shelves are adjustable. All shelves are slotted to accept dividers. Shelf dividers are not included. See [Accessories section](#).

Pulls



Nuform Shapes come standard with inset handle pull at the top of each hinged door.

Lock option

Cabinets come standard without lock. Locking is NOT an option.

Finishes

Available in Office Specialty's standard finishes. Refer to [Finishes section](#) for finish options for case and fronts. Drawer bodies and accessories are finished in Eco Black.

Description	Part number	Exterior Height	Width	Depth	Nuform Classic/ Neutral paint	Nuform Select/ Neutral paint	Accent paint
 Bubble Shape Hinged Door Cabinet, no interior accessories	QSCHD3021	23 $\frac{7}{8}$ "	30"	18"	\$1097	+\$123	+\$111
	QSCHD3621	23 $\frac{7}{8}$ "	36"	18"	\$1130	+\$126	+\$115
	QSCHD4221	23 $\frac{7}{8}$ "	42"	18"	\$1168	+\$130	+\$118
 Bubble Shape Hinged Door Cabinet with 1 slotted shelf	QSCHD3021-SH	23 $\frac{7}{8}$ "	30"	18"	\$1179	+\$131	+\$119
	QSCHD3621-SH	23 $\frac{7}{8}$ "	36"	18"	\$1217	+\$135	+\$124
	QSCHD4221-SH	23 $\frac{7}{8}$ "	42"	18"	\$1260	+\$140	+\$128
 Bubble Shape Hinged Door Cabinet, no interior accessories	QSCHD3024	26 $\frac{7}{8}$ "	30"	18"	\$1141	+\$127	+\$116
	QSCHD3624	26 $\frac{7}{8}$ "	36"	18"	\$1174	+\$131	+\$119
	QSCHD4224	26 $\frac{7}{8}$ "	42"	18"	\$1212	+\$134	+\$123
 Bubble Shape Hinged Door Cabinet with 1 slotted shelf	QSCHD3024-SH	26 $\frac{7}{8}$ "	30"	18"	\$1223	+\$135	+\$124
	QSCHD3624-SH	26 $\frac{7}{8}$ "	36"	18"	\$1261	+\$140	+\$128
	QSCHD4224-SH	26 $\frac{7}{8}$ "	42"	18"	\$1305	+\$144	+\$132
 Bubble Shape Hinged Door Cabinet, no interior accessories	QSCHD3036	38 $\frac{7}{8}$ "	30"	18"	\$1248	+\$139	+\$127
	QSCHD3636	38 $\frac{7}{8}$ "	36"	18"	\$1289	+\$143	+\$130
	QSCHD4236	38 $\frac{7}{8}$ "	42"	18"	\$1335	+\$147	+\$134
 Bubble Shape Hinged Door Cabinet with 1 slotted shelf	QSCHD3036-SH	38 $\frac{7}{8}$ "	30"	18"	\$1331	+\$147	+\$134
	QSCHD3636-SH	38 $\frac{7}{8}$ "	36"	18"	\$1377	+\$154	+\$139
	QSCHD4236-SH	38 $\frac{7}{8}$ "	42"	18"	\$1427	+\$159	+\$144



GRID

US Price List • June 2021

ANSI/BIFMA

With the addition of counterweights where appropriate, Grid pedestals meet all ANSI/BIFMA specifications.

Construction

Pedestals are welded, “wrap-around” construction using 20 gauge high quality, tension leveled, cold rolled steel.

The steel gauges selected for drawer bodies and accessories ensure the highest quality durability and performance for all components.

Construction features & benefits

1. “Wrap-around” construction with no visible vertical seams gives a clean appearance.
2. Completely enclosed case provides rigid construction and dust-free interiors.
3. Box drawer sides are slotted on 1” centers to allow for maximum flexibility for drawer division.
4. File (12”) drawer bodies have full-height sides to accommodate hanging file folders, eliminating the need for optional file frames.
5. Fully-progressive ball bearing suspensions on all drawers, including pencil and box drawers, are staged so that left and right sides work in unison. This provides smooth drawer operation with minimum force.
6. Staged suspensions allow the drawer to be completely pulled out, providing access to the entire drawer depth.
7. Special “claw-like” device incorporated in the suspension “grips” the fixed section of the suspension arm preventing drawer bounce-back or creep when drawer is closed.
8. Casters and glides are both recessed “inboard” for a uniform exterior appearance with no visible hardware.
9. Modular interior allows for complete interchangeability of drawer types within the pedestal case. For example, two 6” box drawers may be replaced by one 12” file drawer.

Counterweights

Counterweights are required for ALL freestanding units that are not anchored or ganged to other cabinets or bolted to walls/floor.

Counterweights come standard with ALL mobile pedestals and must be field installed.

Drawer standard equipment

Pedestals containing 6” drawers have the option to order one pencil tray and one steel divider per pedestal.

12” drawers have the option to order suspension bar for side-to-side filing of letter or legal folders.

Casters

4 Swivel, recessed 1½” black, double-wheel phenolic carpet casters are supplied with mobile pedestals and must be field installed. Recessed casters are not visible.

Glides

Overall heights are inclusive of metal glides. Heights may be increased up to 5/8” by extending standard glide. Glides are accessible from inside the pedestal when the bottom drawer is fully extended or removed and may be adjusted with a ¼” socket driver.

Optional 1½” stem glides are available. Specify separately and add \$30 list to the pedestal price. Requires field installation.

For optional Platform style glide, see the [Accessories Section](#) of this price list.

Locks

Pedestals come standard with lock. For lock location, see diagram at the front of this price list.

Random keying is standard. Pedestals may be ordered keyed alike. Specify. Locks feature removable core and are standard with two keys, one of which has a black neoprene plastic key cover.

Master keys are available at \$51 list.

Tops



Refer to [Accessories Section](#) to specify matching tops.

Finishes

Refer to the [Finish section](#) at the front of this price list.

Drawer Pulls

There are the following pull options for Nuform™ fronts.

Pull	Nuform
 <p>FP001 P290 Aluminum Leaf Finish</p>	
 <p>FP004 Brushed Nickel Finish</p>	
 <p>FP005 Brushed Nickel Finish</p>	

Available

Unavailable

Pulls FP004 and FP005 meet the guidelines for ADA compliance.

How to order

1. Specify product number.
2. Specify case finish.
3. Specify front finish.
4. Specify options.

Product code key example 1518Q-2F

- 15 cabinet width
18 cabinet depth
Q Nuform front
2 number of drawers
F 12" file drawer

NOTE: Pricing for Drawer pull FP001 is standard. For additional pulls review pull option chart.

Pedestals are standard with glides. Exterior pedestal heights are nominal. Actual heights (with glides fully recessed) are 1/8" less.

Counterweights

Counterweights are required for ALL freestanding units that are not anchored or ganged to other cabinets or bolted to walls/floor. Counterweights are standard with all mobile pedestals and must be field installed. See [Counterweight matrix](#).

See [Pedestal Accessories](#) section for counterweight codes and pricing.

Lock option

Pedestals come standard with lock.

Finishes

Refer to [Finish section](#) for finish options for case and Nuform fronts.

Drawer bodies and accessories are finished in Eco Black.

Optional Accessories

All pedestal accessories are optional. See chart below for information on accessories by drawer height.

Drawer Height	Product Code	Product Description	Price
3" & 4.5"	WS-PTxx	Pencil Tray	\$37
6" & 7.5"	WS-PTxx	Pencil Tray	\$37
	WS-DVxx	Divider	\$22
18"D, 22"D, 28"D Pedestals Only (28"D requires 2 per drawer)			
10.5", 12", 13.5, & 15"	SSFxx	Side-To-Side Filing Bar	\$8

Visit the [Pedestal Accessories](#) section for full accessory details.

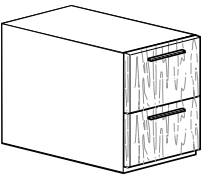
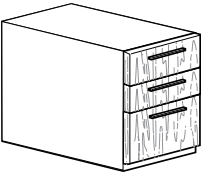
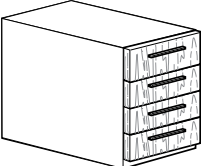
	Description	Part number	Height	Width	Weight (lbs)	Nuform classic/ neutral paint/ base price	Nuform select/ neutral paint	Accent paint
	2-12" file glides	1518Q-2F	26 7/8"	15"	80	\$1169	+\$130	+\$120
		1522Q-2F	26 7/8"	15"	90	\$1232	+\$137	+\$126
		1528Q-2F	26 7/8"	15"	100	\$1408	+\$157	+\$142
	2-6" box, 1-12" file glides	1518Q-2BF	26 7/8"	15"	80	\$1352	+\$151	+\$137
		1522Q-2BF	26 7/8"	15"	90	\$1376	+\$153	+\$140
		1528Q-2BF	26 7/8"	15"	100	\$1510	+\$168	+\$153
	4-6" box glides	1518Q-4B	26 7/8"	15"	80	\$1305	+\$144	+\$132
		1522Q-4B	26 7/8"	15"	90	\$1396	+\$155	+\$141
		1528Q-4B	26 7/8"	15"	100	\$1436	+\$159	+\$145

ANSI/BIFMA

With the addition of counterweights where appropriate, Grid lateral files meet all ANSI/BIFMA specifications.

Construction

Lateral files and hinged door cabinets are of all-welded construction using 20 and 22 gauge high quality, tension leveled, cold rolled steel. The steel gauges selected for drawer bodies and accessories ensure the highest quality durability and performance for all components.

Construction features & benefits

1. All interiors are modular and interchangeable so that cabinets can be retrofitted with new accessories and interiors.
2. Corners are strengthened with a reinforcing gusset and are welded at junction of top and case, eliminating horizontal lines for a cleaner, flush appearance on the face of the cabinet.
3. Fully-progressive ball bearing suspensions are staged so that left and right sides work in unison. This provides smooth drawer operation with minimum force.
4. Special "claw-like" device incorporated in suspensions "grips" the fixed section of the suspension arm preventing drawer bounce-back or creep when drawer is closed.
5. Self-closing, 110° opening, European style cupboard hinges provide smooth hinged door operation. Hinges are not visible from the exterior of the cabinet.

Safelock™

The patented Safelock mechanism provides complete security against accidental opening of two or more drawers simultaneously.

When any drawer or shelf is extended, even fractionally, Safelock ensures that all other openings, except for the 3" drawer, immediately become inoperable. Safelock is standard on all lateral files.

Counterweights

Counterweights are required for ALL freestanding units that are not anchored or ganged to other cabinets or bolted to walls/floor.

Drawer standard equipment

Pullout drawers are standard with one pair hangfile bars for side-to-side suspended filing. Optional accessories are available.

Glides

Overall heights are inclusive of metal glides. Heights may be increased up to $\frac{5}{8}$ " by extending standard glide. Standard glides may be used with or without base aprons. Glides are accessible from inside the cabinet when the bottom drawer is fully extended or removed and may be adjusted with a $\frac{1}{4}$ " socket driver.

Optional $\frac{1}{2}$ " stem glides are available. Specify separately and add \$30 list to the cabinet price. Requires field installation. For optional Platform glide, see [Accessories Section](#) of this price list.

Locks

Cabinets come standard with lock. For lock location, see the diagram at the front of this price list. Random keying is standard. Files may be ordered keyed alike. Specify. Locks feature removable core and are standard with two keys, one of which features a black neoprene plastic cover.

Master keys are available at \$51 list.

Tops



Refer to [Accessories Section](#) to specify matching tops.

Finishes

Refer to the [Finish section](#) at the front of this price list.

Drawer Pulls

There are the following pull options for Nuform™ fronts.

Pull	Nuform
 FP001 P290 Aluminum Leaf Finish	
 FP004 Brushed Nickel Finish	
 FP005 Brushed Nickel Finish	

Available

Unavailable

Pulls FP004 and FP005 meet the guidelines for ADA compliance.

How to order

1. Specify product number.
2. Specify case finish.
3. Specify front finish.
4. Specify options.

Product code key example

36-2FFQ

- 36** cabinet width
- 2** number of drawers
- FF** fixed front drawers
- Q** Nuform front

NOTE: Pricing for Drawer pull FP001 is standard.
For additional pulls review pull option chart.

Exterior cabinet heights are nominal. Actual heights (with glides fully recessed) are $\frac{1}{8}$ " less. Cabinets are priced inclusive of 1 pair of hangfile bars in each pullout opening. Shelves are adjustable except the shelf above the file drawers. All shelves are slotted to accept dividers. Shelf dividers are not included. See [Accessories Section](#).

Counterweights

Counterweights are required for ALL freestanding units that are not anchored or ganged to other cabinets or bolted to walls/floor. Counterweights are standard with all mobile pedestals and must be field installed. See [Counterweight matrix](#).

Accessories

See [Accessories Section](#) for counterweights and accessories.

Lock option

Cabinets come standard with lock.

Finishes

Refer to [Finish section](#) for finish options for case and Nuform fronts. Drawer bodies and accessories are finished in Eco Black.

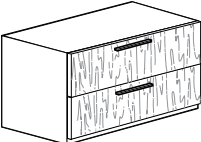
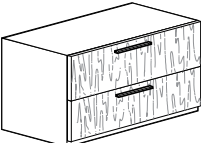
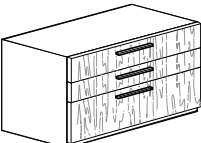
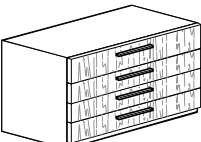
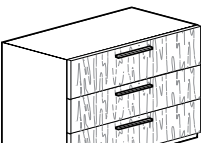
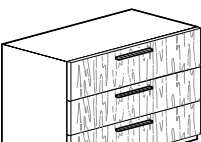
	Description	Part number	Height	Width	Weight (lbs)	Nuform classic/ neutral paint/ base price	Nuform select/ neutral paint	Accent paint
	2 high cabinet	30-21-2FFQ	23 $\frac{7}{8}$ "	30"	80	\$1523	+\$169	+\$154
	2-10.5" fixed front drawers.	36-21-2FFQ	23 $\frac{7}{8}$ "	36"	100	\$1610	+\$179	+\$165
		42-21-2FFQ	23 $\frac{7}{8}$ "	42"	120	\$1650	+\$183	+\$168
	2 high cabinet	30-2FFQ	26 $\frac{7}{8}$ "	30"	100	\$1473	+\$164	+\$148
	2-12" fixed front drawers	36-2FFQ	26 $\frac{7}{8}$ "	36"	120	\$1583	+\$175	+\$161
		42-2FFQ	26 $\frac{7}{8}$ "	42"	130	\$1640	+\$182	+\$167
	2 high cabinet	30-2BFQ	26 $\frac{7}{8}$ "	30"	105	\$1773	+\$197	+\$180
	top 2 openings 6" drawers, bottom opening 12" drawer.	36-2BFQ	26 $\frac{7}{8}$ "	36"	125	\$1892	+\$209	+\$192
		42-2BFQ	26 $\frac{7}{8}$ "	42"	135	\$1976	+\$219	+\$200
	2 high cabinet	30-4BQ	26 $\frac{7}{8}$ "	30"	105	\$2023	+\$223	+\$205
	4-6" drawers.	36-4BQ	26 $\frac{7}{8}$ "	36"	125	\$2194	+\$242	+\$221
		42-4BQ	26 $\frac{7}{8}$ "	42"	135	\$2280	+\$252	+\$229
	3 high cabinet	30-31.5-3FFQ	34 $\frac{3}{8}$ "	30"	120	\$1989	+\$220	+\$201
	3-10.5" fixed front drawers	36-31.5-3FFQ	34 $\frac{3}{8}$ "	36"	140	\$2076	+\$231	+\$210
		42-31.5-3FFQ	34 $\frac{3}{8}$ "	42"	160	\$2164	+\$239	+\$218
	3 high cabinet	30-3FFQ	38 $\frac{7}{8}$ "	30"	120	\$1941	+\$214	+\$197
	3-12" fixed front drawers	36-3FFQ	38 $\frac{7}{8}$ "	36"	140	\$2088	+\$232	+\$211
		42-3FFQ	38 $\frac{7}{8}$ "	42"	160	\$2180	+\$241	+\$220

How to order

1. Specify product number.
2. Specify case finish.
3. Specify front finish.
4. Specify options.

Product code key example

36-3FFQ

- 36** cabinet width
- 3** number of drawers
- FF** fixed front drawers
- Q** Nuform front

NOTE: Pricing for Drawer pull FP001 is standard. For additional pulls review pull option chart.

Exterior cabinet heights are nominal. Actual heights (with glides fully recessed) are $\frac{1}{8}$ " less. Cabinets are priced inclusive of 1 pair of hangfile bars in each pullout opening. Shelves are adjustable except the shelf above the file drawers. All shelves are slotted to accept dividers. Shelf dividers are not included. See [Accessories Section](#).

Counterweights

Counterweights are required for ALL freestanding units that are not anchored or ganged to other cabinets or bolted to walls/floor. Counterweights are standard with all mobile pedestals and must be field installed. See [Counterweight matrix](#).

Accessories

See [Accessories Section](#) for counterweights and accessories.

Lock option

Cabinets come standard with lock.

Finishes

Refer to [Finish section](#) for finish options for case and Nuform fronts. Drawer bodies and accessories are finished in Eco Black.

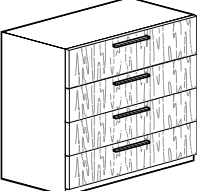
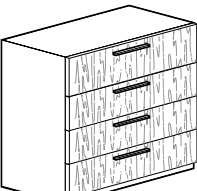
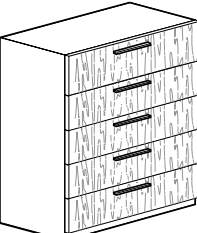
	Description	Part number	Height	Width	Weight (lbs)	Nuform classic/ neutral paint/ base price	Nuform select/ neutral paint	Accent paint
	4 high cabinet	30-42-4FFQ	44 $\frac{7}{8}$ "	30"	140	\$2477	+\$274	+\$250
	4-10.5" fixed	36-42-4FFQ	44 $\frac{7}{8}$ "	36"	160	\$2585	+\$286	+\$262
	front drawers	42-42-4FFQ	44 $\frac{7}{8}$ "	42"	180	\$2695	+\$299	+\$273
	4 high cabinet	30-4FFQ	50 $\frac{7}{8}$ "	30"	140	\$2487	+\$275	+\$251
	4-12" fixed	36-4FFQ	50 $\frac{7}{8}$ "	36"	160	\$2594	+\$287	+\$262
	front drawers	42-4FFQ	50 $\frac{7}{8}$ "	42"	180	\$2696	+\$299	+\$273
	5 high cabinet	30-52.5-5FFQ	55 $\frac{3}{8}$ "	30"	180	\$2914	+\$322	+\$293
	5-10.5" fixed	36-52.5-5FFQ	55 $\frac{3}{8}$ "	36"	205	\$3060	+\$339	+\$308
	front drawers	42-52.5-5FFQ	55 $\frac{3}{8}$ "	42"	240	\$3180	+\$351	+\$321

How to order

1. Specify product number.
2. Specify case finish.
3. Specify front finish.
4. Specify options.

Product code key example

3624HDQ-SH

- 36** cabinet width
24 interior height
HD hinged door
Q Nuform front
SH shelf

NOTE: Pricing for Drawer pull FP001 is standard.
For additional pulls review pull option chart.

Exterior cabinet heights are nominal. Actual heights (with glides fully recessed) are $\frac{1}{8}$ " less. Hinged doors are standard with self-closing European style hinges that open 110°. Shelves are slotted every 1 $\frac{1}{2}$ " and are height adjustable in 1 $\frac{1}{2}$ " increments. Shelf dividers are not included. See [Accessories Section](#).

Accessories

See [Accessories Section](#) for counterweights and accessories.



Lock option

Cabinets come standard with lock.

Finishes

Refer to [Finish section](#) for finish options for case and Nuform fronts.

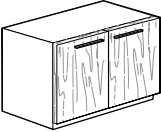
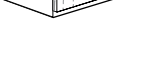
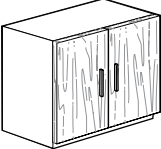
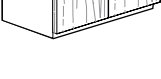
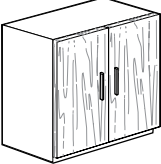
Drawer bodies and accessories are finished in Eco Black.

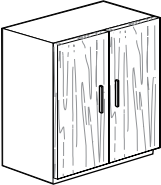
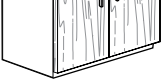
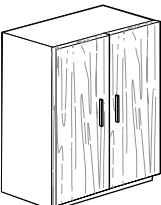
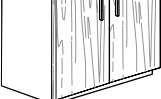
	Description	Part number	Height	Width	Weight (lbs)	Nuform classic/ neutral paint/ base price	Nuform select/ neutral paint	Accent paint
	Cabinet with hinged doors, no interior accessories	3024HDQ	26 $\frac{7}{8}$ "	30"	75	\$1107	+\$124	+\$114
		3624HDQ	26 $\frac{7}{8}$ "	36"	95	\$1198	+\$133	+\$123
		4224HDQ	26 $\frac{7}{8}$ "	42"	110	\$1358	+\$152	+\$138
	Cabinet with hinged doors with 1 slotted shelf	3024HDQ-SH	26 $\frac{7}{8}$ "	30"	85	\$1207	+\$134	+\$124
		3624HDQ-SH	26 $\frac{7}{8}$ "	36"	105	\$1300	+\$144	+\$132
		4224HDQ-SH	26 $\frac{7}{8}$ "	42"	115	\$1449	+\$161	+\$146
	Cabinet with hinged doors, no interior accessories	3031.5HDQ	34 $\frac{3}{8}$ "	30"	85	\$1220	+\$135	+\$125
		3631.5HDQ	34 $\frac{3}{8}$ "	36"	105	\$1316	+\$146	+\$133
		4231.5HDQ	34 $\frac{3}{8}$ "	42"	120	\$1503	+\$167	+\$152
	Cabinet with hinged doors with 1 slotted shelf	3031.5HDQ-SH	34 $\frac{3}{8}$ "	30"	95	\$1323	+\$146	+\$134
		3631.5HDQ-SH	34 $\frac{3}{8}$ "	36"	115	\$1417	+\$158	+\$143
		4231.5HDQ-SH	34 $\frac{3}{8}$ "	42"	125	\$1601	+\$178	+\$164
	Cabinet with hinged doors, no interior accessories	3036HDQ	38 $\frac{7}{8}$ "	30"	130	\$1264	+\$140	+\$129
		3636HDQ	38 $\frac{7}{8}$ "	36"	140	\$1355	+\$151	+\$138
		4236HDQ	38 $\frac{7}{8}$ "	42"	150	\$1546	+\$171	+\$157
	Cabinet with hinged doors with 2 slotted shelves	3036HDQ-SH	38 $\frac{7}{8}$ "	30"	140	\$1464	+\$162	+\$147
		3636HDQ-SH	38 $\frac{7}{8}$ "	36"	150	\$1558	+\$172	+\$159
		4236HDQ-SH	38 $\frac{7}{8}$ "	42"	155	\$1746	+\$194	+\$177
	Cabinet with hinged doors, no interior accessories	3042HDQ	44 $\frac{7}{8}$ "	30"	140	\$1389	+\$155	+\$141
		3642HDQ	44 $\frac{7}{8}$ "	36"	150	\$1524	+\$169	+\$154
		4242HDQ	44 $\frac{7}{8}$ "	42"	160	\$1746	+\$194	+\$177
	Cabinet with hinged doors with 2 slotted shelves	3042HDQ-SH	44 $\frac{7}{8}$ "	30"	150	\$1588	+\$175	+\$162
		3642HDQ-SH	44 $\frac{7}{8}$ "	36"	160	\$1728	+\$192	+\$175
		4242HDQ-SH	44 $\frac{7}{8}$ "	42"	170	\$1947	+\$215	+\$198
	Cabinet with hinged doors, no interior accessories	3048HDQ	50 $\frac{7}{8}$ "	30"	160	\$1420	+\$158	+\$143
		3648HDQ	50 $\frac{7}{8}$ "	36"	170	\$1603	+\$178	+\$164
		4248HDQ	50 $\frac{7}{8}$ "	42"	190	\$1836	+\$204	+\$185
	Cabinet with hinged doors with 2 slotted shelves	3048HDQ-SH	50 $\frac{7}{8}$ "	30"	170	\$1619	+\$180	+\$166
		3648HDQ-SH	50 $\frac{7}{8}$ "	36"	180	\$1806	+\$200	+\$183
		4248HDQ-SH	50 $\frac{7}{8}$ "	42"	200	\$2040	+\$226	+\$207

How to order

1. Specify product number.
2. Specify case finish.
3. Specify front finish.
4. Specify options.

Product code key example 3652.5HDQ-SH

- 36** cabinet width
52.5 interior height
HD hinged door
Q Nuform front
SH shelf

**NOTE: Pricing for Drawer pull FP001 is standard.
For additional pulls review pull option chart.**

Exterior cabinet heights are nominal. Actual heights (with glides fully recessed) are $\frac{1}{8}$ " less. Hinged doors are standard with self-closing European style hinges that open 110°. Shelves are slotted every 1 $\frac{1}{2}$ " and are height adjustable in 1 $\frac{1}{2}$ " increments. Shelf dividers are not included. See [Accessories Section](#).

Accessories

See [Accessories Section](#) for counterweights and accessories.

Lock option

Cabinets come standard with lock.

Finishes

Refer to [Finish section](#) for finish options for case and Nuform fronts. Drawer bodies and accessories are finished in Eco Black.

Description	Part number	Height	Width	Weight (lbs)	Nuform classic/ neutral paint/ base price	Nuform select/ neutral paint	Accent paint
 Cabinet with hinged doors, no interior accessories	3052.5HDQ	55 $\frac{3}{8}$ "	30"	160	\$1577	+\$174	+\$161
	3652.5HDQ	55 $\frac{3}{8}$ "	36"	170	\$1776	+\$197	+\$180
	4252.5HDQ	55 $\frac{3}{8}$ "	42"	190	\$2060	+\$228	+\$208
 Cabinet with hinged doors with 2 slotted shelves	3052.5HDQ-SH	55 $\frac{3}{8}$ "	30"	170	\$1776	+\$197	+\$180
	3652.5HDQ-SH	55 $\frac{3}{8}$ "	36"	180	\$1980	+\$219	+\$201
	4252.5HDQ-SH	55 $\frac{3}{8}$ "	42"	200	\$2262	+\$250	+\$228
 Cabinet with hinged doors, no interior accessories	3060HDQ	62 $\frac{7}{8}$ "	30"	170	\$1646	+\$182	+\$168
	3660HDQ	62 $\frac{7}{8}$ "	36"	185	\$1898	+\$210	+\$192
	4260HDQ	62 $\frac{7}{8}$ "	42"	210	\$2183	+\$241	+\$220
 Cabinet with hinged doors with 3 slotted shelves	3060HDQ-SH	62 $\frac{7}{8}$ "	30"	158	\$1948	+\$215	+\$198
	3660HDQ-SH	62 $\frac{7}{8}$ "	36"	210	\$2200	+\$243	+\$221
	4260HDQ-SH	62 $\frac{7}{8}$ "	42"	230	\$2484	+\$275	+\$251
 Cabinet with hinged doors, 1 full width blank shelf, 3 half width shelves and 1 half width coat rod	3060HDQ-WS	62 $\frac{7}{8}$ "	30"	185	\$2016	+\$223	+\$205
	3660HDQ-WS	62 $\frac{7}{8}$ "	36"	210	\$2270	+\$251	+\$228
	4260HDQ-WS	62 $\frac{7}{8}$ "	42"	230	\$2554	+\$282	+\$258

How to order

1. Specify product number.
2. Specify case finish.
3. Specify front finish.
4. Specify options.

Product code key example

3672HDQ-SH

36 cabinet width
72 interior height
HD hinged door
Q Nuform front
SH shelf

NOTE: Pricing for Drawer pull FP001 is standard.
For additional pulls review pull option chart.

Exterior cabinet heights are nominal. Actual heights (with glides fully recessed) are $\frac{1}{8}$ " less. Hinged doors are standard with self-closing European style hinges that open 110°. Shelves are slotted every 1 $\frac{1}{2}$ " and are height adjustable in 1 $\frac{1}{2}$ " increments. Shelf dividers are not included. See [Accessories Section](#).

Accessories

See [Accessories Section](#) for counterweights and accessories.

Lock option

Cabinets come standard with lock.

Finishes

Refer to [Finish section](#) for finish options for case and Nuform fronts.

Drawer bodies and accessories are finished in Eco Black.

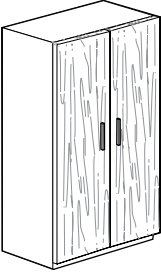
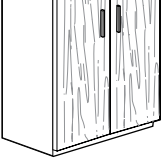
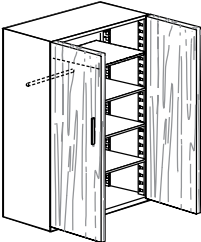
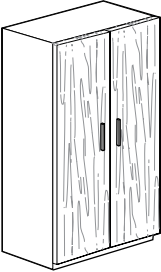
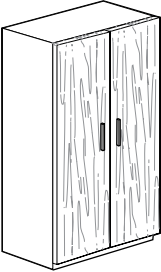
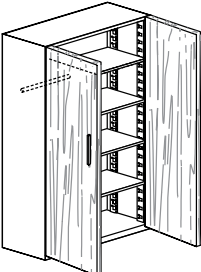
Description	Part number	Height	Width	Weight (lbs)	Nuform classic/ neutral paint/ base price	Nuform select/ neutral paint	Accent paint
 <p>Cabinet with hinged doors, no interior accessories</p>	3072HDQ	74 $\frac{7}{8}$ "	30"	190	\$1995	+\$221	+\$202
	3672HDQ	74 $\frac{7}{8}$ "	36"	220	\$2211	+\$245	+\$222
	4272HDQ	74 $\frac{7}{8}$ "	42"	240	\$2419	+\$268	+\$245
 <p>Cabinet with hinged doors with 4 slotted shelves</p>	3072HDQ-SH	74 $\frac{7}{8}$ "	30"	210	\$2397	+\$265	+\$242
	3672HDQ-SH	74 $\frac{7}{8}$ "	36"	240	\$2614	+\$289	+\$264
	4272HDQ-SH	74 $\frac{7}{8}$ "	42"	260	\$2820	+\$312	+\$285
 <p>Cabinet with hinged doors, 1 full width blank shelf, 3 half width shelves and 1 half width coat rod</p>	3072HDQ-WS	74 $\frac{7}{8}$ "	30"	210	\$2366	+\$262	+\$240
	3672HDQ-WS	74 $\frac{7}{8}$ "	36"	240	\$2582	+\$286	+\$260
	4272HDQ-WS	74 $\frac{7}{8}$ "	42"	260	\$2785	+\$308	+\$281
 <p>Cabinet with hinged doors, no interior accessories</p>	3073.5HDQ	76 $\frac{3}{8}$ "	30"	190	\$2074	+\$231	+\$210
	3673.5HDQ	76 $\frac{3}{8}$ "	36"	220	\$2301	+\$254	+\$233
	4273.5HDQ	76 $\frac{3}{8}$ "	42"	240	\$2511	+\$278	+\$253
 <p>Cabinet with hinged doors with 4 slotted shelves</p>	3073.5HDQ-SH	76 $\frac{3}{8}$ "	30"	210	\$2476	+\$274	+\$250
	3673.5HDQ-SH	76 $\frac{3}{8}$ "	36"	240	\$2702	+\$300	+\$274
	4273.5HDQ-SH	76 $\frac{3}{8}$ "	42"	260	\$2915	+\$322	+\$293
 <p>Cabinet with hinged doors, 1 full width blank shelf, 3 half width shelves and 1 half width coat rod</p>	3073.5HDQ-WS	76 $\frac{3}{8}$ "	30"	210	\$2447	+\$270	+\$248
	3673.5HDQ-WS	76 $\frac{3}{8}$ "	36"	240	\$2669	+\$294	+\$270
	4273.5HDQ-WS	76 $\frac{3}{8}$ "	42"	260	\$2885	+\$319	+\$290

How to order

1. Specify product number.
2. Specify case finish.
3. Specify front finish.
4. Specify options.

Product code key example

3624HD-SH

- 36** cabinet width
- 24** interior height
- HD** hinged door
- J** glazed
- SH** shelf

NOTE: Pricing for Drawer pull FP001 is standard.
For additional pulls review pull option chart.

Exterior cabinet heights are nominal. Actual heights (with glides fully recessed) are $\frac{1}{8}$ " less. Hinged doors are standard with self-closing European style hinges that open 110°. Shelves are slotted every 1 $\frac{1}{2}$ " and are height adjustable in 1 $\frac{1}{2}$ " increments. Shelf dividers are not included. See [Accessories Section](#).

Accessories

See [Accessories Section](#) for counterweights and accessories.

Lock option

Glazed doors do not lock.

Finishes

Refer to [Finish section](#) for finish options for case. Drawer bodies and accessories are finished in Eco Black.

Glazed doors have a standard aluminum finish frame. This frame is not available in other colors. Glazing is sheer frosted acrylic that mounts in front of frame.

Slotted shelves are painted to match the case color.

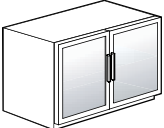
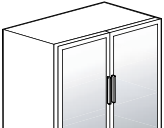
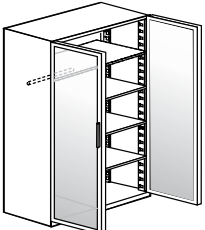
	Description	Part number	Exterior height	Width	Weight (lbs)	Glazed/ Neutral paint	Accent paint
	Cabinet with hinged doors, no interior accessories	3024HDJ	26 $\frac{7}{8}$ "	30"	75	\$1549	+\$159
		3624HDJ	26 $\frac{7}{8}$ "	36"	95	\$1626	+\$166
		4224HDJ	26 $\frac{7}{8}$ "	42"	110	\$1757	+\$178
	Cabinet with hinged doors with 1 slotted shelf	3024HDJ-SH	26 $\frac{7}{8}$ "	30"	80	\$1647	+\$168
		3624HDJ-SH	26 $\frac{7}{8}$ "	36"	100	\$1723	+\$174
		4224HDJ-SH	26 $\frac{7}{8}$ "	42"	115	\$1857	+\$188
	Cabinet with hinged doors, no interior accessories	3036HDJ	38 $\frac{7}{8}$ "	30"	130	\$1909	+\$194
		3636HDJ	38 $\frac{7}{8}$ "	36"	140	\$2013	+\$204
		4236HDJ	38 $\frac{7}{8}$ "	42"	150	\$2212	+\$223
	Cabinet with hinged doors with 2 slotted shelves	3036HDJ-SH	38 $\frac{7}{8}$ "	30"	140	\$2106	+\$212
		3636HDJ-SH	38 $\frac{7}{8}$ "	36"	150	\$2209	+\$222
		4236HDJ-SH	38 $\frac{7}{8}$ "	42"	160	\$2412	+\$245
	Cabinet with hinged doors, no interior accessories	3060HDJ	62 $\frac{7}{8}$ "	30"	170	\$2645	+\$267
		3660HDJ	62 $\frac{7}{8}$ "	36"	185	\$2915	+\$293
		4260HDJ	62 $\frac{7}{8}$ "	42"	200	\$3218	+\$324
	Cabinet with hinged doors with 3 slotted shelves	3060HDJ-SH	62 $\frac{7}{8}$ "	30"	185	\$2940	+\$295
		3660HDJ-SH	62 $\frac{7}{8}$ "	36"	205	\$3211	+\$323
		4260HDJ-SH	62 $\frac{7}{8}$ "	36"	220	\$3514	+\$354
	Cabinet with hinged doors, 1 full width blank shelf, 3 half width shelves and 1 half width coat rod Interior shelf insert painted Eco Black	3060HDJ-WS	62 $\frac{7}{8}$ "	30"	185	\$3008	+\$303
		3660HDJ-WS	62 $\frac{7}{8}$ "	36"	205	\$3278	+\$330
		4260HDJ-WS	62 $\frac{7}{8}$ "	36"	220	\$3581	+\$360

How to order

1. Specify product number.
2. Specify case finish.
3. Specify front finish.
4. Specify options.

Product code key example 3672HD-SH

- 36** cabinet width
72 interior height
HD hinged door
J glazed
SH shelf

**NOTE: Pricing for Drawer pull FP001 is standard.
 For additional pulls review pull option chart.**

Exterior cabinet heights are nominal. Actual heights (with glides fully recessed) are 1/8" less. Hinged doors are standard with self-closing European style hinges that open 110°. Shelves are slotted every 1 1/2" and are height adjustable in 1 1/2" increments. Shelf dividers are not included. See [Accessories Section](#).

Accessories

See [Accessories Section](#) for counterweights and accessories.

Lock option



Glazed doors do not lock.

Finishes

Refer to [Finish section](#) for finish options for case. Drawer bodies and accessories are finished in Eco Black.

Glazed doors have a standard aluminum finish frame. This frame is not available in other colors. Glazing is sheer frosted acrylic that mounts in front of frame.

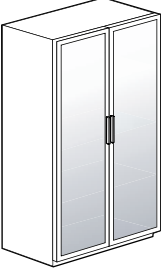
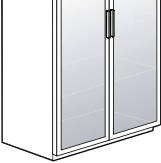
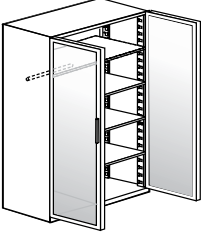
Slotted shelves are painted to match the case color.

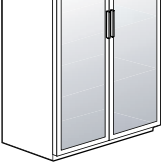
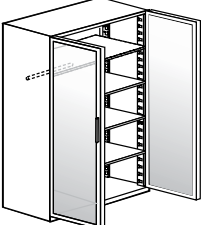
Description	Part number	Exterior height	Width	Weight (lbs)	Glazed/ Neutral paint	Accent paint
	3072HDJ	74 7/8"	30"	190	\$2914	+\$293
	3672HDJ	74 7/8"	36"	220	\$3182	+\$321
	4272HDJ	74 7/8"	42"	240	\$3509	+\$354
	3072HDJ-SH	74 7/8"	30"	210	\$3309	+\$333
	3672HDJ-SH	74 7/8"	36"	240	\$3576	+\$360
	4272HDJ-SH	74 7/8"	42"	260	\$3904	+\$394
	3072HDJ-WS	74 7/8"	30"	210	\$3277	+\$330
	3672HDJ-WS	74 7/8"	36"	240	\$3544	+\$357
	4272HDJ-WS	74 7/8"	42"	260	\$3872	+\$389
	3073.5HDJ	76 3/8"	30"	190	\$3000	+\$302
	3673.5HDJ	76 3/8"	36"	220	\$3277	+\$330
	4273.5HDJ	76 3/8"	42"	240	\$3615	+\$363
	3073.5HDJ-SH	76 3/8"	30"	210	\$3396	+\$342
	3673.5HDJ-SH	76 3/8"	36"	240	\$3671	+\$369
	4273.5HDJ-SH	76 3/8"	42"	260	\$4008	+\$403
	3073.5HDJ-WS	76 3/8"	30"	210	\$3366	+\$340
	3673.5HDJ-WS	76 3/8"	36"	240	\$3640	+\$366
	4273.5HDJ-WS	76 3/8"	42"	260	\$3979	+\$400

How to order

1. Specify product number.
2. Specify case finish.
3. Specify front finish.
4. Specify options.

Product code key example

36-60-HD2FQ

- 36** cabinet width
- 60** interior height
- HD** hinged door
- 2** number of drawers
- F** 12" file drawer
- Q** Nuform front

NOTE: Pricing for Drawer pull FP001 is standard. For additional pulls review pull option chart.

Exterior cabinet heights are nominal. Actual heights (with glides fully recessed) are $\frac{1}{8}$ " less. Hinged doors are standard with self-closing European style hinges that open 110°. Shelves are slotted every 1 $\frac{1}{2}$ " and are height adjustable in 1 $\frac{1}{2}$ " increments. Shelf dividers are not included. See [Accessories Section](#).

Hinged doors are standard with self-closing European style hinges that open 110°. Shelves are slotted every 1 $\frac{1}{2}$ " and are height adjustable in 1 $\frac{1}{2}$ " increments. Shelf dividers are not included. See [Accessories Section](#).

Counterweights

Counterweights are required for ALL freestanding units that are not anchored or ganged to other cabinets or bolted to walls/floor. Counterweights are standard with all mobile pedestals and must be field installed. See [Counterweight matrix](#).

Accessories

See [Accessories Section](#) for counterweights and accessories.

Lock option

Cabinets come standard with lock.

Finishes

Refer to [Finish section](#) for finish options for case and Nuform fronts. Drawer bodies and accessories are finished in Eco Black.

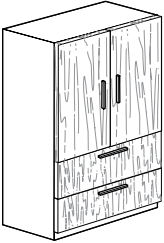
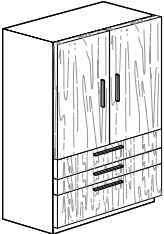
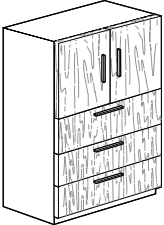
	Description	Part number	Height	Width	Weight (lbs)	Nuform classic/ neutral paint/ base price	Nuform select/ neutral paint	Accent paint
	Cabinet with top opening 36" hinged door cupboard insert with 2 adjustable slotted shelves and 2-12" fixed front drawers	30-60-HD2FQ	62 $\frac{7}{8}$ "	30"	195	\$2866	+\$317	+\$289
		36-60-HD2FQ	62 $\frac{7}{8}$ "	36"	230	\$3114	+\$344	+\$315
		42-60-HD2FQ	62 $\frac{7}{8}$ "	42"	260	\$3379	+\$373	+\$341
	Cabinet with top opening 36" hinged door cupboard insert with 2 adjustable slotted shelves, 2-6" fixed front and 1-12" fixed front drawer	30-60-HD2BFQ	62 $\frac{7}{8}$ "	30"	195	\$3022	+\$333	+\$304
		36-60-HD2BFQ	62 $\frac{7}{8}$ "	36"	230	\$3245	+\$358	+\$327
		42-60-HD2BFQ	62 $\frac{7}{8}$ "	42"	260	\$3532	+\$390	+\$356
	Cabinet with top opening 24" hinged door cupboard insert with 1 adjustable slotted shelf, other 3 openings 12" fixed front drawers	30-60-HD3FQ	62 $\frac{7}{8}$ "	30"	195	\$2995	+\$331	+\$302
		36-60-HD3FQ	62 $\frac{7}{8}$ "	36"	230	\$3245	+\$358	+\$327
		42-60-HD3FQ	62 $\frac{7}{8}$ "	42"	260	\$3508	+\$387	+\$354

How to order

1. Specify product number.
2. Specify case finish.
3. Specify front finish.
4. Specify options.

Product code key example

36-72-HD2FQ

- 36** cabinet width
- 72** interior height
- HD** hinged door
- 2** number of drawers
- F** 12" file drawer
- Q** Nuform front

NOTE: Pricing for Drawer pull FP001 is standard. For additional pulls review pull option chart.

Exterior cabinet heights are nominal. Actual heights (with glides fully recessed) are $\frac{1}{8}$ " less. Hinged doors are standard with self-closing European style hinges that open 110°. Shelves are slotted every 1 $\frac{1}{2}$ " and are height adjustable in 1 $\frac{1}{2}$ " increments. Shelf dividers are not included. See [Accessories Section](#).

Hinged doors are standard with self-closing European style hinges that open 110°. Shelves are slotted every 1 $\frac{1}{2}$ " and are height adjustable in 1 $\frac{1}{2}$ " increments. Shelf dividers are not included. See [Accessories Section](#).

Counterweights

Counterweights are required for ALL freestanding units that are not anchored or ganged to other cabinets or bolted to walls/floor. Counterweights are standard with all mobile pedestals and must be field installed. See [Counterweight matrix](#).

Accessories

See [Accessories Section](#) for counterweights and accessories.

Lock option

Cabinets come standard with lock.

Finishes

Refer to [Finish section](#) for finish options for case and Nuform fronts. Drawer bodies and accessories are finished in Eco Black.

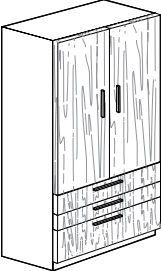
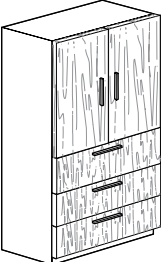
Description	Part number	Height	Width	Weight (lbs)	Nuform classic/ neutral paint/ base price	Nuform select/ neutral paint	Accent paint
 <p>Cabinet with top opening 48" hinged door cupboard insert with 2 adjustable slotted shelves and 2-12" fixed front drawers</p>	30-72-HD2FQ	74 $\frac{7}{8}$ "	30"	250	\$3012	+\$332	+\$303
	36-72-HD2FQ	74 $\frac{7}{8}$ "	36"	270	\$3272	+\$361	+\$330
	42-72-HD2FQ	74 $\frac{7}{8}$ "	42"	291	\$3548	+\$391	+\$357
 <p>Cabinet with top opening 48" hinged door cupboard insert with 2 adjustable slotted shelves, 2-6" fixed front and 1-12" fixed front drawer</p>	30-72-HD2BFQ	74 $\frac{7}{8}$ "	30"	250	\$3172	+\$350	+\$320
	36-72-HD2BFQ	74 $\frac{7}{8}$ "	36"	270	\$3408	+\$376	+\$343
	42-72-HD2BFQ	74 $\frac{7}{8}$ "	42"	291	\$3710	+\$410	+\$373
 <p>Cabinet with top opening 36" hinged door cupboard insert with 2 adjustable slotted shelves, 3-12" fixed front drawers</p>	30-72-HD3FQ	74 $\frac{7}{8}$ "	30"	250	\$3148	+\$348	+\$318
	36-72-HD3FQ	74 $\frac{7}{8}$ "	36"	270	\$3408	+\$376	+\$343
	42-72-HD3FQ	74 $\frac{7}{8}$ "	42"	291	\$3685	+\$407	+\$370

How to order

1. Specify product number.
2. Specify case finish.
3. Specify front finish.
4. Specify options.

Product code key example

36-73.5-HD2FQ

- 36** cabinet width
- 73.5** interior height
- HD** hinged door
- 2** number of drawers
- F** 12" file drawer
- Q** Nuform front

NOTE: Pricing for Drawer pull FP001 is standard. For additional pulls review pull option chart.

Exterior cabinet heights are nominal. Actual heights (with glides fully recessed) are $\frac{1}{8}$ " less. Hinged doors are standard with self-closing European style hinges that open 110°. Shelves are slotted every 1 $\frac{1}{2}$ " and are height adjustable in 1 $\frac{1}{2}$ " increments. Shelf dividers are not included. See [Accessories Section](#).

Hinged doors are standard with self-closing European style hinges that open 110°. Shelves are slotted every 1 $\frac{1}{2}$ " and are height adjustable in 1 $\frac{1}{2}$ " increments. Shelf dividers are not included. See [Accessories Section](#).

Counterweights

Counterweights are required for ALL freestanding units that are not anchored or ganged to other cabinets or bolted to walls/floor. Counterweights are standard with all mobile pedestals and must be field installed. See [Counterweight matrix](#).

Accessories

See [Accessories Section](#) for counterweights and accessories.

Lock option

Cabinets come standard with lock.

Finishes

Refer to [Finish section](#) for finish options for case and Nuform fronts. Drawer bodies and accessories are finished in Eco Black.

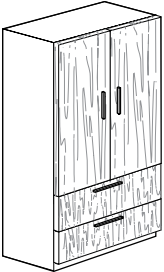
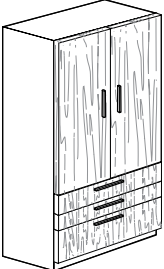
Description	Part number	Height	Width	Weight (lbs)	Nuform classic/ neutral paint/ base price	Nuform select/ neutral paint	Accent paint
	30-73.5-HD2FQ	76 $\frac{3}{8}$ "	30"	250	\$3071	+\$340	+\$309
	36-73.5-HD2FQ	76 $\frac{3}{8}$ "	36"	270	\$3334	+\$368	+\$336
	42-73.5-HD2FQ	76 $\frac{3}{8}$ "	42"	291	\$3618	+\$399	+\$363
	30-73.5-HD2BFQ	76 $\frac{3}{8}$ "	30"	250	\$3237	+\$357	+\$327
	36-73.5-HD2BFQ	76 $\frac{3}{8}$ "	36"	270	\$3474	+\$384	+\$350
	42-73.5-HD2BFQ	76 $\frac{3}{8}$ "	42"	291	\$3779	+\$417	+\$380

How to order

1. Specify product number.
2. Specify case finish.
3. Specify front finish.
4. Specify options.

Product code key example

36-60-HD2FJQ

- 36** cabinet width
- 60** interior height
- HD** hinged door
- 2** number of drawers
- F** 12" file drawer
- J** glazed
- Q** Nuform front

NOTE: Pricing for Drawer pull FP001 is standard. For additional pulls review pull option chart.

Exterior cabinet heights are nominal. Actual heights (with glides fully recessed) are $\frac{1}{8}$ " less. Cabinets are priced inclusive of 1 pair of hangfile bars in each pullout opening. Shelves are adjustable except the shelf above the file drawers. All shelves are slotted to accept dividers. Shelf dividers are not included.

Hinged doors are standard with self-closing European style hinges that open 110°. Shelves are slotted every 1½" and are height adjustable in 1½" increments. Shelf dividers are not included. See [Accessories Section](#).

Counterweights

Counterweights are required for ALL freestanding units that are not anchored or ganged to other cabinets or bolted to walls/floor. Counterweights are standard with all mobile pedestals and must be field installed. See [Counterweight matrix](#).

Accessories

See [Accessories Section](#) for counterweights and accessories.

Lock option

Cabinets come standard with lock.

Glazed doors do not lock.

Finishes

Refer to [Finish section](#) for finish options for case and Nuform fronts.

Drawer bodies and accessories are finished in Eco Black.

Glazed doors have a standard aluminum finish frame. This frame is not available in other colors. Glazing is sheer frosted acrylic that mounts in front of frame.

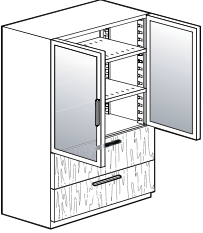
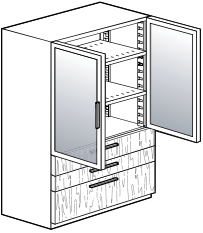
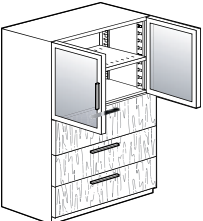
Description	Part number	Height	Width	Weight (lbs)	Nuform classic/ neutral paint/ base price	Nuform select/ neutral paint	Accent paint
 <p>Cabinet with top opening 36" hinged door cupboard insert with 2 adjustable slotted shelves and 2-12" fixed front drawers</p>	30-60-HD2FJQ	62 $\frac{7}{8}$ "	30"	195	\$3704	+\$410	+\$373
	36-60-HD2FJQ	62 $\frac{7}{8}$ "	36"	230	\$3924	+\$432	+\$396
	42-60-HD2FJQ	62 $\frac{7}{8}$ "	42"	260	\$4130	+\$456	+\$415
 <p>Cabinet with top opening 36" hinged door cupboard insert with 2 adjustable slotted shelves, 2-6" fixed front and 1-12" fixed front drawer</p>	30-60-HD2BFJQ	62 $\frac{7}{8}$ "	30"	195	\$3860	+\$426	+\$388
	36-60-HD2BFJQ	62 $\frac{7}{8}$ "	36"	230	\$4070	+\$450	+\$410
	42-60-HD2BFJQ	62 $\frac{7}{8}$ "	42"	260	\$4285	+\$472	+\$431
 <p>Cabinet with top opening 24" hinged door cupboard insert with 1 adjustable slotted shelf, 3-12" fixed front drawers</p>	30-60-HD3FJQ	62 $\frac{7}{8}$ "	30"	195	\$3499	+\$386	+\$353
	36-60-HD3FJQ	62 $\frac{7}{8}$ "	36"	230	\$3676	+\$405	+\$369
	42-60-HD3FJQ	62 $\frac{7}{8}$ "	42"	260	\$3851	+\$425	+\$387

How to order

1. Specify product number.
2. Specify case finish.
3. Specify front finish.
4. Specify options.

Product code key example

36-72-HD2FJQ

- 36** cabinet width
- 72** interior height
- HD** hinged door
- 2** number of drawers
- F** 12" file drawer
- J** glazed
- Q** Nuform front

NOTE: Pricing for Drawer pull FP001 is standard. For additional pulls review pull option chart.

Exterior cabinet heights are nominal. Actual heights (with glides fully recessed) are 1/8" less. Cabinets are priced inclusive of 1 pair of hangfile bars in each pullout opening. Shelves are adjustable except the shelf above the file drawers. All shelves are slotted to accept dividers. Shelf dividers are not included.

Hinged doors are standard with self-closing European style hinges that open 110°. Shelves are slotted every 1 1/2" and are height adjustable in 1 1/2" increments. Shelf dividers are not included. See [Accessories Section](#).

Counterweights

Counterweights are required for ALL freestanding units that are not anchored or ganged to other cabinets or bolted to walls/floor. Counterweights are standard with all mobile pedestals and must be field installed. See [Counterweight matrix](#).

Accessories

See [Accessories Section](#) for counterweights and accessories.

Lock option

Cabinets come standard with lock.

Glazed doors do not lock.

Finishes

Refer to [Finish section](#) for finish options for case and Nuform fronts.

Drawer bodies and accessories are finished in Eco Black.

Glazed doors have a standard aluminum finish frame. This frame is not available in other colors. Glazing is sheer frosted acrylic that mounts in front of frame.

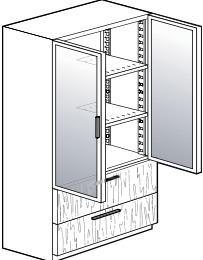
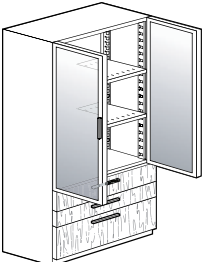
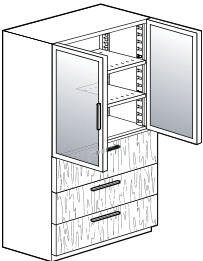
Description	Part number	Height	Width	Weight (lbs)	Nuform classic/ neutral paint/ base price	Nuform select/ neutral paint	Accent paint
	30-72-HD2FJQ	74 7/8"	30"	250	\$3890	+\$429	+\$393
	36-72-HD2FJQ	74 7/8"	36"	270	\$4120	+\$455	+\$414
	42-72-HD2FJQ	74 7/8"	42"	291	\$4337	+\$478	+\$436
	30-72-HD2BFJQ	74 7/8"	30"	250	\$4054	+\$448	+\$408
	36-72-HD2BFJQ	74 7/8"	36"	270	\$4276	+\$471	+\$430
	42-72-HD2BFJQ	74 7/8"	42"	291	\$4497	+\$496	+\$452
	30-72-HD3FJQ	74 7/8"	30"	250	\$3675	+\$405	+\$369
	36-72-HD3FJQ	74 7/8"	36"	270	\$3856	+\$426	+\$388
	42-72-HD3FJQ	74 7/8"	42"	291	\$4047	+\$448	+\$407

How to order

1. Specify product number.
2. Specify case finish.
3. Specify front finish.
4. Specify options.

Product code key example

36-72-HD2FJQ

- 36** cabinet width
- 72** interior height
- HD** hinged door
- 2** number of drawers
- F** 12" file drawer
- J** glazed
- Q** Nuform front

NOTE: Pricing for Drawer pull FP001 is standard. For additional pulls review pull option chart.

Exterior cabinet heights are nominal. Actual heights (with glides fully recessed) are $\frac{1}{8}$ " less. Cabinets are priced inclusive of 1 pair of hangfile bars in each pullout opening. Shelves are adjustable except the shelf above the file drawers. All shelves are slotted to accept dividers. Shelf dividers are not included.

Hinged doors are standard with self-closing European style hinges that open 110°. Shelves are slotted every 1½" and are height adjustable in 1½" increments. Shelf dividers are not included. See [Accessories Section](#).

Counterweights

Counterweights are required for ALL freestanding units that are not anchored or ganged to other cabinets or bolted to walls/floor. Counterweights are standard with all mobile pedestals and must be field installed. See [Counterweight matrix](#).

Accessories

See [Accessories Section](#) for counterweights and accessories.

Lock option

Cabinets come standard with lock.

Glazed doors do not lock.

Finishes

Refer to [Finish section](#) for finish options for case and Nuform fronts.

Drawer bodies and accessories are finished in Eco Black.

Glazed doors have a standard aluminum finish frame. This frame is not available in other colors. Glazing is sheer frosted acrylic that mounts in front of frame.

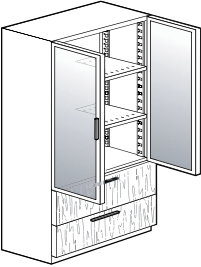
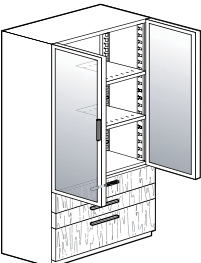
Description	Part number	Height	Width	Weight (lbs)	Nuform classic/ neutral paint/ base price	Nuform select/ neutral paint	Accent paint
 <p>Cabinet with top opening 49.5" hinged door cupboard insert with 2 adjustable slotted shelves and 2-12" fixed front drawers</p>	30-73.5-HD2FJQ	76 $\frac{3}{8}$ "	30"	250	\$3967	+\$438	+\$399
	36-73.5-HD2FJQ	76 $\frac{3}{8}$ "	36"	270	\$4201	+\$464	+\$423
	42-73.5-HD2FJQ	76 $\frac{3}{8}$ "	42"	291	\$4421	+\$489	+\$443
 <p>Cabinet with top opening 49.5" hinged door cupboard insert with 2 adjustable slotted shelves, 2-6" fixed front and 1-12" fixed front drawer</p>	30-73.5-HD2BFJQ	76 $\frac{3}{8}$ "	30"	250	\$4133	+\$456	+\$416
	36-73.5-HD2BFJQ	76 $\frac{3}{8}$ "	36"	270	\$4362	+\$481	+\$438
	42-73.5-HD2BFJQ	76 $\frac{3}{8}$ "	42"	291	\$4588	+\$506	+\$462

Storage Accessories

US Price List • June 2021



Accessories

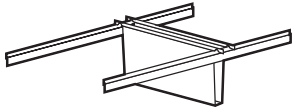

Hangfile bars

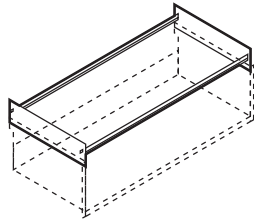

EDP Kit

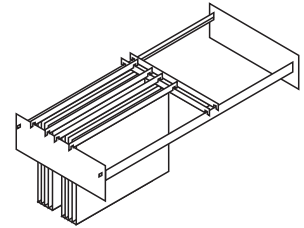

X-ray Kit

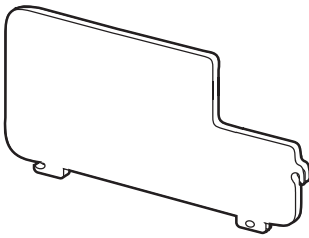
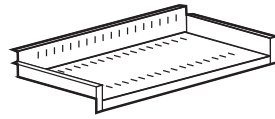
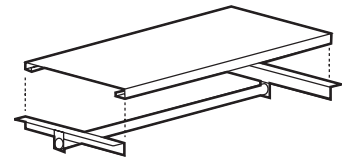

Plate divider



Fixed slotted shelf



Coat rod and blank shelf

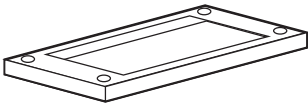

Lateral Base



Sliding Rail

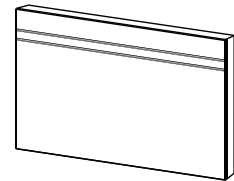

Counterweight for laterals

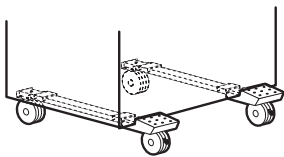

Mobile support frame

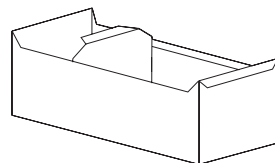

Card Tray
"The dh Collection"

Accessories

For pedestals
Letter and Legal Widths

How to order

1. Specify product number.
2. Specify finish color if necessary.

Finishes

Accessories are finished in Eco Black.

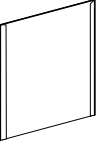
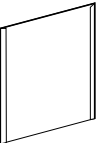
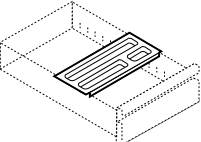
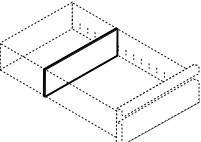
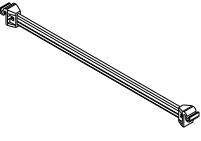
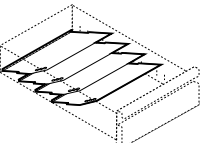
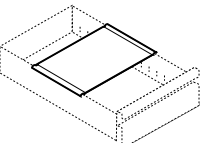
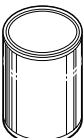
Description	Part number	Width	Depth	Weight (lbs)	List price
 <p>Counterweight, recommended for all freestanding pedestals with file and EDP drawers</p>	WS-CW	—	—	16	\$99
 <p>Counterweight, recommended for all mobile pedestals *For all non-standard Pedestals please consult our Specials Engineering Department for appropriate counterweight(s) to be used.</p>	PM-CW	—	—	24	\$99
 <p>Pencil tray for letter width box drawer. Black plastic.</p>	WS-PT15	15"	—	1	\$37
	WS-PT18	18"	—	1	\$37
 <p>Divider for box drawer</p>	WS-DV15	15"	3 ½"	—	\$22
	WS-DV18	18"	3 ½"	—	\$22
 <p>Side-to-Side Filing Bar</p>	SSF15	15"	—	—	\$8
	SSF18	18"	—	—	\$8
 <p>Set of 4 modular sloped stationery dividers, fits box drawer letter width pedestal.</p>	MD-SO15	15"	—	1	\$74
	MD-SO18	18"	—	1	\$79
 <p>Sliding reference shelf for box drawer, fits letter width pedestal only</p>	WS-RS	12"	—	1	\$57
 <p>Touch-up paint for standard enamel finishes. Specify finish. Can contains ½ pint</p>	PAINT	—	—	1	\$45

Storage Accessories

For pedestals
Letter and Legal Widths

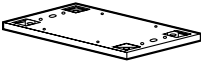
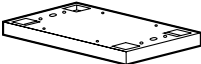
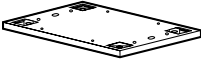
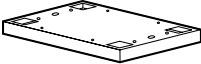
	Description	Part number	Height	Width	Depth	Weight (lbs)	Neutral paint/ base price	Accent paint
	<u>7/8" base apron</u> <u>letter width</u> <u>(height does not</u> <u>include glide)</u>	<u>B1518-1</u>	7/8"	15"	18"	3	\$101	+\$13
		<u>B1522-1</u>	7/8"	15"	22"	4	\$101	+\$13
		<u>B1528-1</u>	7/8"	15"	28"	5	\$101	+\$13
	<u>2 1/8" base apron</u> <u>letter width</u> <u>(height does not</u> <u>include glide)</u>	<u>B1518-2</u>	2 1/8"	15"	18"	4	\$111	+\$15
		<u>B1522-2</u>	2 1/8"	15"	22"	5	\$111	+\$15
		<u>B1528-2</u>	2 1/8"	15"	28"	6	\$111	+\$15
	<u>7/8" base apron</u> <u>legal width</u> <u>(height does not</u> <u>include glide)</u>	<u>B1822-1</u>	7/8"	18"	22"	4	\$128	+\$16
		<u>B1828-1</u>	7/8"	18"	28"	5	\$128	+\$16
	<u>2 1/8" base apron</u> <u>legal width</u> <u>(height does not</u> <u>include glide)</u>	<u>B1822-2</u>	2 1/8"	18"	22"	6	\$138	+\$17
		<u>B1828-2</u>	2 1/8"	18"	28"	7	\$138	+\$17

Accessories

Interior Accessories for All Laterals



How to order

1. Specify product number.
2. Specify finish color if necessary.

The accessories on these pages are used in conjunction with basic cabinets and desired drawer and shelf interiors.

Finishes

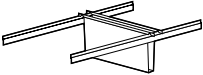
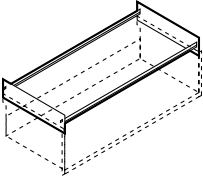
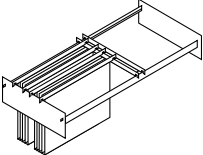
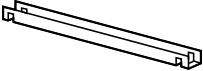
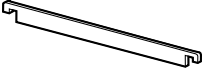
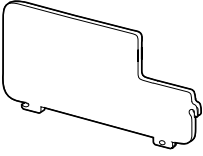
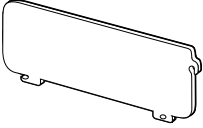
Accessories are finished in Eco Black.

Description	Part number	Width	Weight (lbs)	List price
 <p>Standard Paper Related Accessories Hangfile bars for 10.5", 12", 13.5", 15" and 16.5" pullout shelves/drawers set of 2</p>	<u>HF-30</u>	30"	2	\$45
	<u>HF-36</u>	36"	3	\$45
	<u>HF-42</u>	42"	4	\$45
 <p>Computer Paper Related Accessories EDP kit for 13.5" and 15" shelves/drawers Includes Hang File Bars</p>	<u>EDP30</u>	30"	6	\$81
	<u>EDP36</u>	36"	7	\$81
	<u>EDP42</u>	42"	8	\$81
 <p>X-Ray Related Accessories X-ray kit for 16.5" drawers Includes sliding rail and hang file bars</p>	<u>XRAY/EDP30</u>	30"	2	\$90
	<u>XRAY/EDP36</u>	36"	3	\$90
	<u>XRAY/EDP42</u>	42"	3	\$90
 <p>Sliding rails used in conjunction with HF bars for front-to-back filing, sold individually.</p>	<u>SR</u>	1 3/16"	1	\$16
 <p>Legal to letter adapter</p>	<u>LL-30</u>	30"	1	\$25
	<u>LL-36</u>	36"	2	\$25
	<u>LL-42</u>	42"	3	\$25
 <p>Plate divider for 10.5", 12", 13.5", 15" and 16.5" drawers or slotted shelves</p>	<u>DVP</u>	—	1	\$21
 <p>Plate divider for 6", 7.5" and 9" shelves/drawers</p>	<u>DVP6-9</u>	—	1	\$21
 <p>Plate divider for 3" and 4.5" shelves/drawers</p>	<u>DVP-3</u>	—	1	\$21

Storage Accessories

Interior Accessories for All Laterals

How to order

1. Specify product number.
2. Specify finish color if necessary.

The accessories on these pages are used in conjunction with basic cabinets and desired drawer and shelf interiors.

Finishes

Accessories are finished in Eco Black.

Slotted shelves are available in any of Office Specialty's standard paint finishes.

Description	Part number	Height	Width	Depth	Weight (lbs)	List price
 Follower plate, includes velcro fasteners	FP	3 1/2"	3 1/2"	2"	—	\$18
 Drawer filler for 6" and 7.5" drawers only. Available for 9900 Series .	DF30	—	30"	—	2	\$26
	DF36	—	36"	—	3	\$27
	DF42	—	42"	—	3	\$31
 SuperStor™ trays Pack of 12 trays, black only	T12SS-BL	—	10"	—	25	\$268

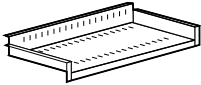
Description	Part number	Height	Width	Depth	Weight (lbs)	Neutral paint/ base price	Accent paint
 Slotted Shelf Fixed slotted shelf installs behind 12", 13.5", 15" and 16.5" lift-up doors or in hinged door cabinets. Shelf is adjustable on a 1.5" increment.	SH-30	—	30"	18"	11	\$101	+\$13
	SH-36	—	36"	18"	12	\$101	+\$13
	SH-42	—	42"	18"	13	\$101	+\$13

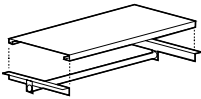
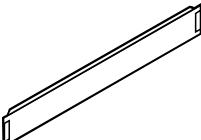
Description	Part number	Height	Width	Depth	Weight (lbs)	List price
 Coat rod and blank shelf. Rod screws to underside of shelf.	CR30	—	30"	16"	11	\$137
	CR36	—	36"	16"	12	\$137
	CR42	—	42"	16"	13	\$137
 Raised back kit. Attaches to back of 10.5", 12", 13.5", 15" and 16.5" drawers.	RBKIT-30	—	30"	—	2	\$25
	RBKIT-36	—	36"	—	3	\$26
	RBKIT-42	—	42"	—	3	\$27

Storage Accessories

Interior Accessories for All Laterals

How to order

1. Specify product number.
2. Specify finish color if necessary.

The accessories on these pages are used in conjunction with basic cabinets and desired drawer and shelf interiors.

Finishes

Accessories are finished in Eco Black.

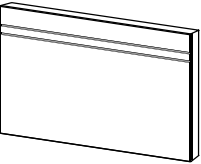
	Description	Part number	Height	Width	Depth	Weight (lbs)	List price
	<u>Counterweight, recommended for all freestanding lateral file cabinets with 22.5" interior dimension or higher</u>	IMCW-30	—	—	—	38	\$144
		IMCW-36	—	—	—	38	\$144
		IMCW-42	—	—	—	52	\$144
	<u>Counterweight, recommended for all freestanding lateral file cabinets with less than 22.5" interior dimension</u>	CW	—	—	—	48	\$144
	<u>Counterweight, for non-standard lateral files when recommended by Specials Engineering Department. Secures with 2-way tape.</u>	PFCW	—	—	—	32	\$144

Storage Accessories

Interior Accessories for All Laterals/Hinged Door Units

How to order

1. Specify product number.
2. Specify finish color if necessary.

The accessories on these pages are used in conjunction with basic cabinets and desired drawer and shelf interiors.

Finishes

Available in any of Office Specialty's standard paint finishes.

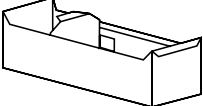
	Description	Part number	Height	Width	Depth	Weight (lbs)	Neutral paint/ base price	Accent paint
	<u>Tray Accessories</u> Tray for 3" x 5" cards or 4 1/4" x 2 3/4" cassettes. Requires 4 1/2" drawer.	<u>CT53-MP</u>	2 3/4"	5 3/8"	14 7/8"	4	\$139	+\$17
	<u>Tray for 4" x 6" cards or microfiche.</u> Requires 6" shelf/drawer.	<u>CT64-MP</u>	3 3/4"	6 3/8"	14 7/8"	5	\$139	+\$17
	<u>Tray for 5" x 8" cards.</u> Requires 6" drawer.	<u>CT85-MP</u>	4 7/8"	8 3/16"	14 7/8"	6	\$139	+\$17
	<u>Tray for 3 1/4" x 7 3/8" TAB cards.</u> Requires 6" drawer.	<u>CT-TAB-MP</u>	3"	7 7/8"	14 7/8"	5	\$139	+\$17
	<u>Tray for cheques.</u> Requires 6" drawer.	<u>CT-CK-MP</u>	3 1/4"	8 15/16"	15 1/2"	5	\$180	+\$21

Storage Accessories

For all laterals

How to order



1. Specify product number.
2. Specify finish color if necessary.

Bases are steel welded construction, flush with glides.

Finishes

Bases are available in any of Office Specialty's standard or textured paint finishes. Refer to [Finishes section](#).

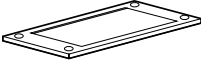
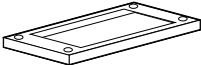
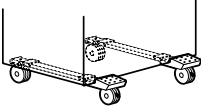
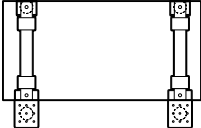
Mobile support frames come standard with black plastic bumpers and casters.

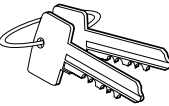
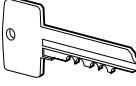
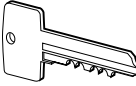
	Description	Part number	Height	Width	Depth	Weight (lbs)	Neutral paint/ base price	Accent paint
	<u>Bases</u>	<u>B3018-1</u>	7/8"	30"	18"	4	\$119	+\$15
	<u>7/8"</u>	<u>B3618-1</u>	7/8"	36"	18"	5	\$119	+\$15
	<u>(height does not include glide)</u>	<u>B4218-1</u>	7/8"	42"	18"	5	\$119	+\$15
	<u>2 1/8"</u>	<u>B3018-2</u>	2 1/8"	30"	18"	8	\$132	+\$17
	<u>(height does not include glide)</u>	<u>B3618-2</u>	2 1/8"	36"	18"	9	\$132	+\$17
		<u>B4218-2</u>	2 1/8"	42"	18"	10	\$132	+\$17
	<u>18" mobile support frame, for 30" and 36" wide lateral files with maximum of three pullout drawers and maximum interior height of 43.5"</u> <u>Note: Counterweight must be installed in lateral file</u>	<u>MFK18</u>	4 5/8"	18"	4 1/2"	10		\$540
	<u>24" mobile support frame, for 24" and 30" wide Workplace Towers with maximum of three pullout drawers and maximum height of 58 3/4"</u> <u>Note: Counterweight is recommended</u>	<u>MFK24</u>	4 5/8"	24"	4 1/2"	11		\$540
	<u>Ganging Kit</u>	<u>GK</u>	—	—	—	—	—	\$15
	<u>Replacement Key</u> <u>1 Key</u> <u>Specify key number found on face of lock</u>	<u>RKEY</u>	—	—	—	—	—	\$12
	<u>Extractor Key</u> <u>1 Key</u> <u>Used to remove lock cores from file cabinets</u>	<u>EKEY</u>	—	—	—	—	—	\$51
	<u>Master Key</u> <u>1 Key</u> <u>Specify key series</u>	<u>MKEY</u>	—	—	—	—	—	\$51

Storage Accessories

For all laterals

How to order

1. Specify product number.
2. Specify finish color if necessary.

The accessories on these pages are used in conjunction with basic cabinets and desired drawer and shelf interiors.

Finishes

Lock Core is available in three finishes: black, satin chrome and bright chrome.

Touch up paint is available in any of our standard paint colors.

	Description	Part number	Height	Width	Depth	Weight (lbs)	List price
	<u>Comes with core and two keys</u>	<u>LAT-SB-CORE</u>	—	—	—	—	\$27
	<u>Touch-up paint for standard enamel finishes.</u> <u>Specify finish.</u> <u>Can contains 1/2 pint</u>	<u>PAINT</u>	—	—	—	1	\$45
	<u>Label Holder for 9900</u>	<u>LBLHLDR-99LN</u>	—	—	—	—	\$7

How to order



1. Specify product number.
2. Specify finish color if necessary.

Optional laminate tops are self-edged, high pressure laminate with backing sheet, over a core of high density particle board.

Finishes

Tops are available in any standard Office Specialty laminate (OCC codes). Refer to [Finishes section](#).

Note that plywood edge is not an option on these tops as they are self-edged.

Description	Part number	Thickness	Width	Depth	Weight (lbs)	Laminate/ base price	Grade 1 laminate
 <u>18"D Laminate Tops</u>	<u>PL-30</u>	1 1/16"	30"	18"	15	\$263	+\$86
	<u>PL-36</u>	1 1/16"	36"	18"	20	\$301	+\$98
	<u>PL-42</u>	1 1/16"	42"	18"	25	\$315	+\$102
	<u>PL-60</u>	1 1/16"	60"	18"	30	\$445	+\$144
	<u>PL-72</u>	1 1/16"	72"	18"	40	\$535	+\$173
	<u>PL-84</u>	1 1/16"	84"	18"	50	\$621	+\$201
 <u>36"D Laminate Tops</u>	<u>PL-3630</u>	1 1/16"	30"	36"	35	\$507	+\$165
	<u>PL-3636</u>	1 1/16"	36"	36"	42	\$560	+\$180
	<u>PL-3642</u>	1 1/16"	42"	36"	49	\$584	+\$188
	<u>PL-3660</u>	1 1/16"	60"	36"	69	\$835	+\$268
	<u>PL-3666</u>	1 1/16"	66"	36"	76	\$893	+\$287
	<u>PL-3672</u>	1 1/16"	72"	36"	83	\$1002	+\$322
	<u>PL-3684</u>	1 1/16"	84"	36"	97	\$1221	+\$393

Storage Accessories

How to order

1. Specify product number.
2. Specify finish color.
3. Specify options.

Product code key example



N□1930

N Nuform top
□ **S** - Classic
W - Select
19 depth
30 width

Nuform Tops are available in single and double depths. **Note: Top will overhang lateral ½" front and back. If single-depth lateral is positioned flush against a wall, there will be a 1" overhang at the front.**

Finishes

Available in Nuform Classic and Nuform Select finishes. Refer to [Finishes section](#).

Description	Part number	Thickness	Width	Depth	Weight (lbs)	Nuform Classic/ base price	Nuform Select
 Nuform Tops	<u>N□1930</u>	1 ¼"	30"	19"	18	\$263	\$294
	<u>N□1936</u>	1 ¼"	36"	19"	21	\$301	\$340
	<u>N□1942</u>	1 ¼"	42"	19"	25	\$315	\$353
	<u>N□1960</u>	1 ¼"	60"	19"	36	\$445	\$505
	<u>N□1966</u>	1 ¼"	66"	19"	39	\$493	\$551
	<u>N□1972</u>	1 ¼"	72"	19"	43	\$535	\$602
	<u>N□1978</u>	1 ¼"	78"	19"	46	\$579	\$650
	<u>N□1984</u>	1 ¼"	84"	19"	50	\$621	\$696
	<u>N□1990</u>	1 ¼"	90"	19"	53	\$665	\$746
<u>N□1996</u>	1 ¼"	96"	19"	57	\$708	\$792	
 Nuform Tops	<u>N□3730</u>	1 ¼"	30"	37"	35	\$507	\$566
	<u>N□3736</u>	1 ¼"	36"	37"	42	\$560	\$628
	<u>N□3742</u>	1 ¼"	42"	37"	49	\$584	\$659
	<u>N□3760</u>	1 ¼"	60"	37"	69	\$835	\$939
	<u>N□3766</u>	1 ¼"	66"	37"	76	\$893	\$1001
	<u>N□3772</u>	1 ¼"	72"	37"	83	\$1002	\$1126
	<u>N□3778</u>	1 ¼"	78"	37"	90	\$1112	\$1250
	<u>N□3784</u>	1 ¼"	84"	37"	97	\$1221	\$1370
	<u>N□3790</u>	1 ¼"	90"	37"	104	\$1331	\$1496
<u>N□3796</u>	1 ¼"	96"	37"	111	\$1440	\$1615	

How to order

1. Specify product number.
2. Specify upholstery name and number.

The **Classic Cushion** is 1 ¼" thick CAL 117 compliant polyurethane foam with a 2.3 lb/ft. density. This upholstered cushion is balanced with a 7/16" board and is attached to the pedestal top with heavy duty Velcro. The 5-pc construction, features double row top stitching on all seams, seen in fine upholstered pieces. The result provides crisp rectilinear styling.

The **Lite Cushion** is ¾" thick CAL 117 compliant polyurethane foam with a 2.3 lb/ft. density. This upholstered cushion is balanced with a ¼" board and is attached to the pedestal top with Velcro. Our Lite Cushion has seamless features allowing it to highlight the fabric details. The result provides a modern and simple look. The Lite Cushion is available in the following Grade A fabrics only: Fedora, Glint, Pebble, Rancho & Script

Upholstery

Select from our graded upholstery program of solid color fabrics and vinyls or choose COM option (Customers Own Material). To determine if a COM fabric has been pre-approved for use on our cushion topper, contact your Client Services Representative or go to officespecialty.com. Refer to page 15 for additional layout and COM details.

Due to the nature of the design and manufacture of our cushion, only approved fabrics will be accepted for application. For a description of the procedure required for COM fabric approval see sample 'Cushion COM Test Request' form found in the [General Information](#) section of this price list. This form can be downloaded from [Insite](#) or by contacting your Client Services Representative for assistance.

Description	Part number	Thickness	Width	Weight (lbs)	Grade A	Grade B /COM	Grade C	Grade D	Grade E	Grade F
	<u>CSH15X188X075L</u>	¾"	15"	4	\$162	—	—	—	—	—
	<u>CSH15X228X075L</u>	¾"	15"	5	\$169	—	—	—	—	—
	<u>CSH15X288X075L</u>	¾"	15"	7	\$179	—	—	—	—	—
<u>15" w Lite Pedestal Cushion (9900 Series)</u>										

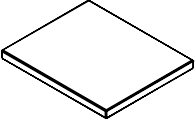
	<u>CSH15X18.75X125</u>	1 ¼"	15"	8	\$276	+\$57	+\$103	+\$145	+\$174	+\$249
	<u>CSH15X22.75X125</u>	1 ¼"	15"	9	\$282	+\$57	+\$103	+\$145	+\$174	+\$249
	<u>CSH15X28.75X125</u>	1 ¼"	15"	13	\$292	+\$57	+\$103	+\$145	+\$174	+\$249
<u>15" w Classic Pedestal Cushion (9900 Series)</u>										

How to order





1. Specify product number.
2. Specify upholstery name and number.

The **Classic Cushion** is 1 1/4" thick CAL 117 compliant polyurethane foam with a 2.3 lb/ft. density. This upholstered cushion is balanced with a 7/16" board and is attached to the lateral top with heavy duty Velcro. The 5-pc construction, features double row top stitching on all seams, seen in fine upholstered pieces. The result provides crisp rectilinear styling.

Upholstery







Select from our graded upholstery program of solid color fabrics and vinyls or choose COM option (Customers Own Material). To determine if a COM fabric has been pre-approved for use on our cushion topper, contact your Client Services Representative or go to [officespecialty.com](https://www.officespecialty.com). Refer to page 15 for additional layout and COM details.

Due to the nature of the design and manufacture of our cushion, only approved fabrics will be accepted for application. For a description of the procedure required for COM fabric approval see sample 'Cushion COM Test Request' form found in the [General Information](#) section of this price list. This form can be downloaded from [Insite](#) or by contacting your Client Services Representative for assistance.

Description	Part number	Thickness	Width	Weight (lbs)	Grade A	Grade B /COM	Grade C	Grade D	Grade E	Grade F
 18" d Classic Lateral Cushion (standard application)	LATCUSH1830SL	1 1/4"	30"	7	\$425	+\$84	+\$165	+\$199	+\$247	+\$363
	LATCUSH1836SL	1 1/4"	36"	8	\$462	+\$97	+\$192	+\$233	+\$287	+\$425
	LATCUSH1842SL	1 1/4"	42"	10	\$501	+\$110	+\$214	+\$267	+\$329	+\$485
	LATCUSH1860SL	1 1/4"	60"	14	\$605	+\$151	+\$296	+\$366	+\$451	+\$664
	LATCUSH1866SL	1 1/4"	66"	15	\$658	+\$177	+\$327	+\$402	+\$495	+\$728
	LATCUSH1872SL	1 1/4"	72"	15	\$713	+\$179	+\$354	+\$436	+\$534	+\$788
	LATCUSH1878SL	1 1/4"	78"	17	\$781	+\$208	+\$408	+\$505	+\$619	+\$909
LATCUSH1884SL	1 1/4"	84"	24	\$832	+\$237	+\$437	+\$584	+\$704	+\$1005	
 19 3/4" Classic Lateral Cushion (Benching application with electrical)	LATCUSH19830SL	1 1/4"	30"	7	\$435	+\$84	+\$164	+\$199	+\$246	+\$362
	LATCUSH19836SL	1 1/4"	36"	8	\$476	+\$96	+\$191	+\$231	+\$286	+\$424
	LATCUSH19842SL	1 1/4"	42"	10	\$516	+\$108	+\$216	+\$266	+\$328	+\$596
	LATCUSH19860SL	1 1/4"	60"	14	\$641	+\$151	+\$299	+\$367	+\$452	+\$665
	LATCUSH19866SL	1 1/4"	66"	15	\$682	+\$166	+\$326	+\$400	+\$494	+\$725
	LATCUSH19872SL	1 1/4"	72"	15	\$722	+\$179	+\$353	+\$435	+\$534	+\$787
	LATCUSH19878SL	1 1/4"	78"	17	\$764	+\$194	+\$380	+\$467	+\$576	+\$846
LATCUSH19884SL	1 1/4"	84"	24	\$806	+\$207	+\$407	+\$503	+\$617	+\$907	
 21 1/2" Classic Lateral Cushion (Private Office application with electrical)	LATCUSH21530SL	1 1/4"	30"	7	\$435	+\$89	+\$170	+\$205	+\$251	+\$368
	LATCUSH21536SL	1 1/4"	36"	8	\$482	+\$96	+\$191	+\$231	+\$286	+\$424
	LATCUSH21542SL	1 1/4"	42"	11	\$518	+\$108	+\$216	+\$265	+\$328	+\$484
	LATCUSH21560SL	1 1/4"	60"	15	\$659	+\$151	+\$296	+\$366	+\$451	+\$664
	LATCUSH21566SL	1 1/4"	66"	16	\$701	+\$165	+\$326	+\$399	+\$492	+\$724
	LATCUSH21572SL	1 1/4"	72"	17	\$746	+\$178	+\$353	+\$434	+\$532	+\$786
	LATCUSH21578SL	1 1/4"	78"	18	\$759	+\$194	+\$383	+\$547	+\$658	+\$939
LATCUSH21584SL	1 1/4"	84"	25	\$793	+\$237	+\$437	+\$584	+\$704	+\$1005	
 36" d Classic Lateral Cushion (back-to-back application)	LATCUSH3630SL	1 1/4"	30"	14	\$524	+\$79	+\$161	+\$192	+\$239	+\$356
	LATCUSH3636SL	1 1/4"	36"	19	\$577	+\$92	+\$187	+\$223	+\$279	+\$415
	LATCUSH3642SL	1 1/4"	42"	19	\$609	+\$105	+\$213	+\$259	+\$321	+\$476
 39 1/2" Classic Lateral Cushion (Back-to-back benching application with electrical)	LATCUSH39530SL	1 1/4"	30"	14	\$532	+\$79	+\$160	+\$191	+\$238	+\$355
	LATCUSH39536SL	1 1/4"	36"	15	\$580	+\$92	+\$212	+\$251	+\$306	+\$445
	LATCUSH39542SL	1 1/4"	42"	16	\$660	+\$105	+\$228	+\$267	+\$319	+\$475

How to order

1. Specify product number.







	Description	Part number	List price
	<p><u>Standard Flat Pedestal Glides</u> Set of 4</p>	<p>LV001</p>	<p>\$30</p>
	<p><u>Extended Flat Pedestal Glides</u> Set of 4</p>	<p>LV002</p>	<p>\$30</p>
	<p><u>Standard Flat Lateral Glides</u> Set of 4</p>	<p>LV003</p>	<p>\$30</p>
	<p><u>Extended Flat Lateral Glides</u> Set of 4 (previously LG)</p>	<p>LV004</p>	<p>\$30</p>
	<p><u>2" dia. Round Bookcase Glides, Black</u> Set of 4</p>	<p>LV009</p>	<p>\$30</p>
	<p><u>2" dia. Round Bookcase Glides, Grey</u> Set of 4</p>	<p>LV010</p>	<p>\$31</p>

Storage Accessories

Glides

How to order



1. Specify product number.

	Description	Part number	List price
	<u>2" dia. Round Pedestal and Lateral Glides, Black</u> <u>Set of 4</u>	LV011	\$27
	<u>2" dia. Round Pedestal and Lateral Glides, Grey</u> <u>Set of 4</u>	LV012	\$27
	<u>2" dia. Round Storwal Lateral Glides, Black</u> <u>Set of 4</u>	LV013	\$27
	<u>2" dia. Round Storwal Lateral Glides, Grey</u> <u>Set of 4</u>	LV014	\$27
	<u>2" dia. Round Storwal Bookcase Glides, Black</u> <u>Set of 4</u>	LV015	\$30
	<u>2" dia. Round Storwal Bookcase Glides, Grey</u> <u>Set of 4</u>	LV016	\$30

Storage Accessories

How to order

- 1. Specify product number.

	Description	Part number	List price
	<u>Rectangular Lateral Glides, Grey</u> <u>Set of 4</u>	LV018	\$102
	<u>Rectangular Pedestal Glides, Grey</u> <u>Set of 4</u>	LV019	\$102

Accessories

Modular Towers

How to order

1. Specify product number.

Specification Guidelines

- A maximum of 6 CD compartments may be positioned inside MoPed, 3 on the top rail and 3 on the lower rail. Note: If CD compartments are positioned on top rail, top two slots in compartments are not accessible.
- Compartments and support brackets hook onto any one of three rails inside the drawer.
- Compartments may also be placed on lower level of drawer. 3 ¾" wide compartment may be placed into upper level of drawer.
- Although pencil tray is designed for use in upper compartment it will fit on lower level of drawer.

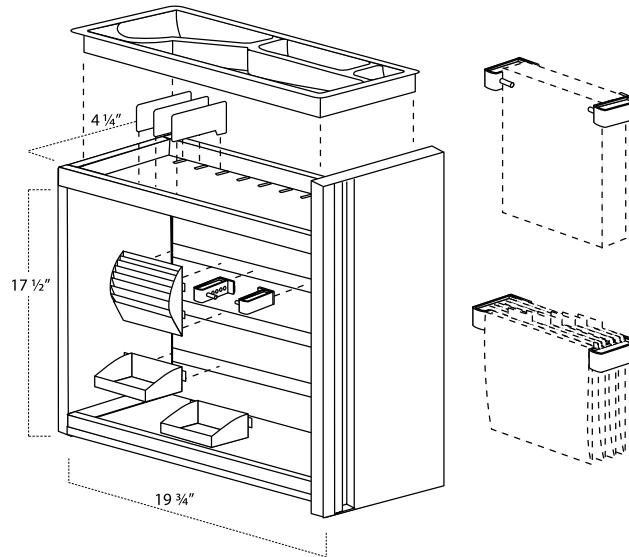





Support Brackets

Adjustable posts on support brackets may be specified to hold objects from 9/16" to 3 1/4" thick in place.

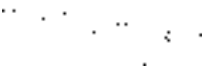
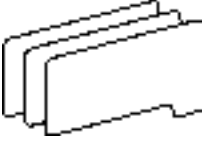
or

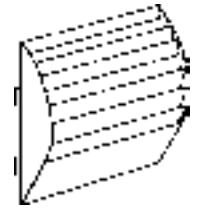
Support brackets may be specified to suspend hanging files. Adjustable posts may be removed if brackets are specified for this application.

	Description	Part number	Height	Width	Depth	Weight (lbs)	List price
	Pencil Tray Plastic - silver	OS-PFM-PT19	1"	4 1/4"	19 1/2"	—	\$29
	Dividers Up to 9" dividers will fit in upper compartment. Pkg. of 3 Plastic - transparent	OS-PFM-DVP	1"	4 1/4"	—	1	\$23
	Storage Compartments Plastic - transparent	OS-SC4334 OS-SC4534 OS-SC4734 OS-SC41134	1 1/2" 1 1/2" 1 1/2" 1 1/2"	3 3/4" 5 3/4" 7 3/4" 11 3/4"	4" 4" 4" 4"	— — — —	\$25 \$27 \$29 \$31
	CD Compartment Holds 8 CD's Plastic - Transparent	OS-CDC	7"	5"	—	—	\$33
	Support Brackets Includes 1 right-handed and 1 left-handed bracket each with removable post. Plastic - Transparent Post - Aluminum	OS-SBKT	2"	1 1/4"	3 3/4"	—	\$56
	Starter Package includes: 1 x pencil tray 1 x CD tray 2 x 5 3/4" compartments 2 x 3 3/4" compartments 1 x support brackets	OS-SPKG	-	—	—	1	\$187

How to order

1. Specify product number.

Whiteboards have raised edges at each end and include a separate 10 ½" wide marker tray. Whiteboards and marker trays are manufactured from steel and mount magnetically. Marker tray and side trim on whiteboards are field installed.

Modular Towers Mobile Kit comes with two locking swivel casters, two non-locking swivel casters and a counterweight. Mobile Kit can only be mounted on Office Specialty Modular Storage Towers with an exterior case height of 46 ½" or higher and having a pedestal drawer configuration that does not exceed 30" interior dimensional opening.

Note: The mobile kit adds 3 ½" to the height.

Finishes

Whiteboards are powder coated in white paint specially formulated for dry erase markers. Marker tray and raised edges on whiteboard are finished in black.

Note: Whiteboards are not intended for use with PERMANENT markers. Only Expo Markers are to be used on any Office Specialty Whiteboard. Whiteboards should be cleaned with Expo Eraser or a Microfiber cleaning cloth along with Expo Cleaning Solution which is formulated to remove residue from Expo Dry Erase Markers.

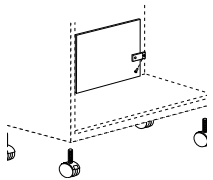
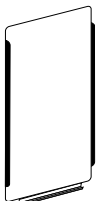
Description	Part number	Height	Width	Depth	Weight (lbs)	List price
 <p>Mobile Kit can only be mounted on towers with an exterior case height of 46.5" or higher and having a pedestal drawer configuration that does not exceed 30". Note: The mobile kit adds 3.25" to the height of the tower.</p>	<u>MTMK</u>	3 ¼"	—	—	22	\$174
 <p>Magnetic Whiteboards for side-access towers. Includes marker tray.</p>	<u>MWB13165</u> <u>MWB1318</u> <u>MWB13195</u> <u>MWB13315</u> <u>MWB1333</u>	16 ½" 18" 19 ½" 31 ½" 33"	13 ¾" 13 ¾" 13 ¾" 13 ¾" 13 ¾"	— — — — —	10 13 14 16 18	\$276 \$282 \$291 \$301 \$310

How to order

1. Specify product number.
2. Specify finish color if necessary.

Bases are steel welded construction, flush with glides.

Finishes

Bases are available in any standard or textured finish. Refer to [Finishes section](#).

All interior accessories are finished in Eco Black.

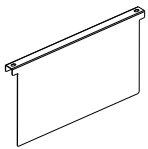
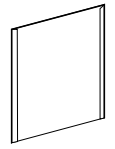
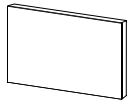
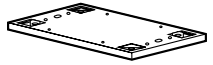
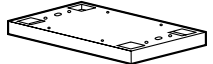
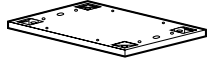
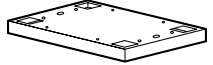
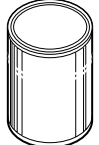
	Description	Part number	Height	Width	Depth	Weight (lbs)	List price
	<u>Vertical Compressor</u>	CP15 <u>Letter width</u>	—	15"	—	3	\$20
		CP18 <u>Legal width</u>	—	18"	—	3	\$20
	<u>Counterweight, recommended for all freestanding pedestals with file and EDP drawers</u>	WS-CW	—	—	—	16	\$99
	<u>Counterweight for use in Waste/Recycle Bin Vertical Files</u>	PFCW3	—	—	16	16	\$144
	7/8" base apron letter width (height does not include glide)	B1528-1	7/8"	15"	28"	5	\$101
	2 1/8" base apron letter width (height does not include glide)	B1528-2	2 1/8"	15"	28"	6	\$111
	7/8" base apron legal width (height does not include glide)	B1828-1	7/8"	18"	28"	5	\$128
	2 1/8" base apron legal width (height does not include glide)	B1828-2	2 1/8"	18"	28"	7	\$138
	Touch-up paint for standard enamel finishes. Specify finish. Can contains 1/2 pint	PAINT	—	—	—	1	\$45

Storage Accessories

eLock Multi-USB Port Charger Kit

General information

- Included in kit: 20-port USB 2.0 charger, twenty 6-Foot USB 2.0 cables, power cord, mounting bracket, instruction sheet, carrying case
- Charges up to 20 ports at one time
- Kit includes the standard kit in a carry case plus 1 5' Micro-B connector
- LED indicator lights show which USB ports are in use at any given time
- Security Module: Over-current, Over-voltage, Short circuit protection, CE, FCC, ROHS approval
- Power adapter with 20V/4.5

	Description	Part number	List price
	<u>eLock Multi-USB Port Charger Kit</u>	<u>ELCHRG-MP20</u>	\$1323

Workstations

US Price List • June 2021





RockIt

US Price List • June 2021

Core and Supports

US Price List • June 2021





- Back-to-back core application is standard with base pricing
- Core is available in any of Office Specialty's standard paint colors
- Core is available in three conditions: double end, middle, single end. Specify "middle" condition if power pole is needed
- In a 90° application, to give the recommended space behind a user, the recommended minimum core length for a 30"D worksurface is 72", and for a 24"D worksurface is 60"
- Accessory gasket is always included in core slot
- Angled Leg Hip Supports (RKCSPAx(x)) are used in both mid and end applications and are not handed. The 90° End Angled Leg Hip Supports (RKWSPAxx) are specific to the unsupported end of the surface.
- Leg post on all Angled Leg Hip Supports can be optioned as wood or painted steel
- Leg posts and hip are available in any of Office Specialty's standard paint colors
- Angled Leg Hip Supports always includes a gasket for accessories in hip slot
- Angled Leg Hip Supports comes with optional Hip Top Cover: open accessory slot or full cover (color options available). Accessories cannot be mounted in full cover.
- 8" Core Supporting Angled Leg Hip Support is only available with a full top cover therefore no accessories can be mounted here
- Hip Top Covers can also be ordered separately as needed
- 48" or 60" 90° Double Sided End Angled Leg Hip Supports must be used on either 2 fixed worksurfaces or 2 SkyRockit Height Adjustable worksurfaces

Application Legend

 = Linear Workstations

 = 90° Workstations

	Part number	Height	Width	Depth	Neutral paint/ base price	Accent paint upcharge	Single sided application upcharge
 <p>Core  </p>	RKCR48	5"	48"	3"	\$404	+\$43	+\$79
	RKCR54	5"	54"	3"	\$435	+\$45	+\$96
	RKCR60	5"	60"	3"	\$466	+\$48	+\$114
	RKCR66	5"	66"	3"	\$530	+\$54	+\$124
	RKCR72	5"	72"	3"	\$592	+\$61	+\$141

	Part number	Depth	Neutral paint/ base price	Leg			Hip	Top Cover
				Accent paint upcharge	Wood Upcharge	Accent paint upcharge	Accent paint upcharge	
 <p>Single Sided Angled Leg Hip Support Top Cover with accessory slot illustrated </p>	RKCSPA24	24"	\$639	+\$65	+\$64	+\$65	+\$5	
	RKCSPA30	30"	\$722	+\$73	+\$73	+\$73	+\$5	
 <p>Double Sided Angled Leg Hip Support Top Cover with accessory slot illustrated </p>	RKCSPA48	48"	\$759	+\$78	+\$77	+\$78	+\$6	
	RKCSPA60	60"	\$872	+\$89	+\$88	+\$89	+\$6	
 <p>8" Core Supporting Angled Leg Hip Support </p>	RKCSPA8	8"	\$549	+\$57	+\$56	+\$57	+\$5	
 <p>90° Single Sided End Angled Leg Hip Support </p>	RKWSPA24	24"	\$665	+\$69	+\$67	+\$69	+\$6	
	RKWSPA30	30"	\$735	+\$76	+\$74	+\$76	+\$6	
 <p>90° Double Sided End Angled Leg Hip Support </p>	RKWSPA48	48"	\$875	+\$90	+\$88	+\$90	+\$7	
	RKWSPA60	60"	\$983	+\$101	+\$99	+\$101	+\$8	

- The optional Reinforcement Bar can be added to the Angled Leg Hip Support to strengthen any double sided RockIt application. The bar is not required for a light user but is recommend for medium to heavy users.
- 2 station applications require an end Reinforcement Bar on both sides
- 4 station or larger applications require a mid Reinforcement Bar on each Hip Support that is supporting surfaces off both sides. For these applications, no end bars are required.
- Reinforcement Bars are available in any of Office Specialty's paint colors

- The Leg Anchor Bracket is required to have a freestanding RockIt core and is available in any of Office Specialty's standard colors
- Freestanding Core must be bolted to concrete floor using a minimum of 2 anchor brackets at each end

Application Legend

- Ⓛ = Linear Workstations
- 90° = 90° Workstations
- ⓕ = Freestanding

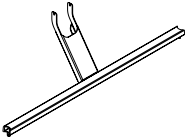
		Part number	Neutral paint/ base price	Accent paint upcharge
	RockIt Reinforcement Bar for end application Ⓛ	RKCSSTBEND48	\$148	+\$17
		RKCSSTBEND60	\$156	+\$17

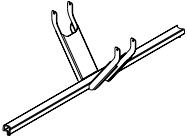

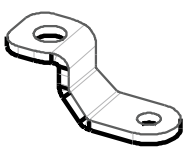
	RockIt Reinforcement Bar for mid application Ⓛ	RKCSSTBMID48	\$219	+\$23
		RKCSSTBMID60	\$227	+\$24

		Part number	Neutral paint/ base price	Accent paint upcharge
	Leg Anchor Bracket ⓕ	RKLABKT	\$44	+\$6

- Optional Hip Top Cover is available with open accessory slot or full cover (color options available). Accessories can not be mounted in full cover.
- Hip Top Covers can also be ordered separately as needed

Application Legend

- Ⓛ = Linear Workstations
- 90° = 90° Workstations

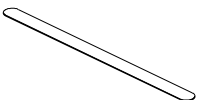
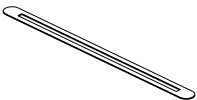
		Part number	Depth	Neutral paint/ base price	Accent paint upcharge
	Replacement Leg Hip Full Top Cover Ⓛ	RKCSTOPFC24	24"	\$24	+\$5
		RKCSTOPFC30	30"	\$24	+\$5
		RKCSTOPFC48	48"	\$40	+\$6
		RKCSTOPFC60	60"	\$40	+\$6
	Replacement Leg Hip Top Cover with slot for accessories Ⓛ	RKCSTOPAS24	24"	\$24	+\$5
		RKCSTOPAS30	30"	\$24	+\$5
		RKCSTOPAS48	48"	\$40	+\$6
		RKCSTOPAS60	60"	\$40	+\$6
	Replacement 8" Core Leg Hip Full Top Cover 90°	RKCSTOPFC8	8"	\$27	+\$4
	Replacement 90° End Leg Hip Full Top Cover 90°	RKWSTOPFC24	24"	\$38	+\$6
		RKWSTOPFC30	30"	\$44	+\$6
		RKWSTOPFC48	48"	\$60	+\$8
		RKWSTOPFC60	60"	\$71	+\$9
	Replacement 90° End Leg Hip Top Cover with slot for accessories 90°	RKWSTOPAS24	24"	\$44	+\$6
		RKWSTOPAS30	30"	\$49	+\$7
		RKWSTOPAS48	48"	\$81	+\$10
		RKWSTOPAS60	60"	\$92	+\$12

Electrical

US Price List • June 2021

- Power In-Feeds may enter into the core from the floor and must enter the core on the opposite end to the data ports
- Power In-Feeds have a 7' long whip
- A wire covering is included with the Power In-Feed (RKEFWK-8) to enclose exposed power
- The wire covering has two options available: Cable Casing (available in silver only) or Cable Sleeve (available in black, beige, gray or white)
- 8" Core Leg Power In-Feed with Cover includes the In-Feed but has the option for no power and an optional Cable Sleeve (available in black, beige, gray or white)
- The Cable Sleeve has been factory cut on both ends with a hot knife, to help stop fraying. Care must be taken when opening Velcro at ends. Though not recommended, if sleeve must be cut shorter on-site, hide cut end up inside core, using care and zip tie/tape to help stop fraying.
- New York City Power In-Feed comes complete with attachment bracket which is available in any of Office Specialty's standard paint colors
- Both Power In-Feeds with Cover are only compatible with the 8" Core Supporting Angled Leg Hip Support
- Both Power In-Feeds with Cover have the option to select mid or end application. End option is fully covered. Mid option has opening at the top.
- Power In-Feeds do not require access through a duplex location
- All Power In-Feeds with Cover are available in any of Office Specialty's standard paint colors
- 8" Core Leg New York City Power In-Feed with Cover includes the in-feed. If cover only is required, please use regular version and option no power.

Application Legend

- Ⓛ = Linear Workstations
- 90° = 90° Workstations

	Part number	List price
 <p>Power In-Feed Ⓛ</p>	RKEFWK-8	\$350

 <p>City of Chicago Bracket (pkg of 2) Ⓛ 90°</p>	RKECHB	\$351
---	---------------	-------

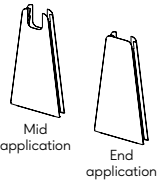
	Part number	Neutral paint/ base price	Accent paint upcharge	No power option	Optional cable sleeve
 <p>8" Core Leg Power In-Feed with Cover 90°</p> <p>Mid application End application</p>	RK90EFCVR-8	\$524	+\$64	-\$270	+\$125

	Part number	Neutral paint/ base price	Accent paint upcharge
 <p>New York City Power In-Feed Ⓛ</p>	RKEFWK-NY-8	\$621	+\$12

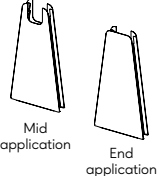
 <p>8" Core Leg New York City Power In-Feed with Cover 90°</p> <p>Mid application End application</p>	RK90EFCVRNY-8	\$621	+\$75
---	----------------------	-------	-------

- The Ceiling Power Poles must be located at the end of a Core, opposite to the data ports, against the end Angled Leg Hip Support
- The Ceiling Power Poles has two pole options that accommodate up to an 11' ceiling (16' power feed whip) and 17' ceiling (22' power feed whip). The option to select no power is also available if the pole is only to be used for data.
- Ceiling Power Poles must be specified with "middle" application Core in the end location
- A center septum is included in the Ceiling Power Pole
- Ceiling Power Poles are available in any of Office Specialty's standard paint colors

Application Legend



- Ⓛ = Linear Workstations
- 90° = 90° Workstations







	Part number	Neutral paint/ base price	Optional 22' whip	No power option	Accent paint upcharge
 <p>Ceiling Power Pole Ⓛ 90°</p>	RKECFK-8	\$884	+\$694	-\$235	+\$89

- Power Tracks are required to match the width of the core it is being installed in
- Receptacles and Jumper Cables (track to track connectors) are specified separately from Power Tracks

- One size of Jumper Cable works for all surface widths
- Jumper Cables do not connect together nor do they attach to Power In-Feeds

Application Legend

-  = Linear Workstations
-  = 90° Workstations













		Part number	Width	List price
	No Match!  	RKETP48-8	48"	\$155
		RKETP54-8	54"	\$166
		RKETP60-8	60"	\$168
		RKETP66-8	66"	\$188
		RKETP72-8	72"	\$197
	No Match!  	RKETC36-8	36"	\$76

- Power Modules mount to the back edge of a surface and are accessible by the user above the surface
- Power Modules plug into the duplexes
- The Clamp-On Power Module is available in a black or white finish. It has a 96" long power cord and LED surge protection indication. It attaches to 1" and 1 1/4" thick worksurfaces and the mount includes a device holder.
- The Clamp-On Power Module with Colored Components comes in many different configurations with receptacles, USB (1 type A and 1 type B) ports and availability lights. Power Modules come in black, white or gray and have colored options for the lid; Black, White, Teal, Red, Purple, Blue, Green, Gray. The availability light is user controlled and requires a free software download.
- All electrical components on this page are field installed

Application Legend

 = Linear Workstations

 = 90° Workstations

	Part number	List price
 <p>Clamp-On Power Module 3 receptacles/1 dual USB port  </p>	RKPMOD-3PIU	\$173
 <p>Clamp-On Power Module with Colored Components 2 Ports: 1 receptacle + 1 USB AC  </p>	RKPMOD-1PIU	\$437
 <p>Clamp-On Power Module with Colored Components 4 Ports: 2 receptacles + 1 USB AC + 1 open data port data not provided  </p>	RKPMOD-2PIU10	\$548
 <p>Clamp-On Power Module with Colored Components 4 Ports: 2 receptacles + 1 USB AC + 1 availability light  </p>	RKPMOD-2PIU1L	\$867









- Standard and Controlled Receptacles are available in the color options of black (default), white and gray
- White option is a close match to 168 Glacier White and the Gray option is a close match to 290 Aluminum Leaf
- USB Receptacles are available in black option only
- The circuit 3 receptacle requires 2+2 or 3+1 wire designation (“U” in the code signifies 3+1 compatibility)

- Controlled receptacles satisfy California Title 24 and are indicated with a “power mark” which is represented by a circle with a line

Application Legend

 = Linear Workstations

 = 90° Workstations

		Part number	List price	White	Gray
	Receptacles  	RK2D1-8	\$26	+\$10	+\$10
		RK2D2-8	\$26	+\$10	+\$10
		RK2D3-8	\$26	+\$10	+\$10
		RK2D3U-8	\$26	+\$10	+\$10
		RK2D4-8	\$26	+\$10	+\$10
	USB Receptacles  	RK2USB1-8	\$162	—	—
		RK2USB2-8	\$162	—	—
		RK2USB3-8	\$162	—	—
		RK2USB3U-8	\$162	—	—
		RK2USB4-8	\$162	—	—
	Controlled Receptacles  	RK2D1-8C	\$31	+\$10	+\$10
		RK2D2-8C	\$31	+\$10	+\$10
		RK2D3-8C	\$31	+\$10	+\$10
		RK2D3U-8C	\$31	+\$10	+\$10
		RK2D4-8C	\$31	+\$10	+\$10

- The Hinged Cover is a plastic cover that acts as a hinged door to allow access to the cables if needed. Available in color options of black (default), white and gray
- White option is a close match to 168 Glacier White and the Gray option is a close match to 290 Aluminum Leaf
- Data cutouts are located on the opposite side from a power in-feed on the core

- Data cutouts are staggered slightly to ease back to back routing in the core
- The Data Cutout Cover completely conceals the data cutout when they are not in use. It is steel and is available in any of Office Specialty’s standard paint colors.

Application Legend

- Ⓛ = Linear Workstations
- 90° = 90° Workstations

	Part number	List price	White	Gray
 <p>Hinged Cover Ⓛ 90°</p>	RKHRC	\$21	+\$10	+\$10

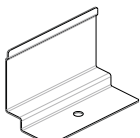
	Part number	Neutral paint/ base price	Accent paint upcharge
 <p>Data Cutout Cover Ⓛ 90°</p>	RKCDCC	\$17	+\$3

- The Cable Management Tray (RKCMT18) attaches straight to the front rail of the core to accommodate surface cabling and is available in Eco Black paint only
- The Cable Management Tray for 90° Workstations (RK90CMT18) attach to the worksurface to accommodate surface cabling and is available in Eco Black paint only
- Height Adjustable Cable Management Trays attach to the underside of the height adjustable worksurface to accommodate cabling
- The Height Adjustable Cable Management Trays are a combination of a cable management tray with a bracket that attaches a self rolled protective cable sleeve to the core
- The Height Adjustable Cable Management Trays are only available in Eco Black paint and the bracket is available in any of Office Specialty's standard paint colors
- The cable sleeve is 3' in length and is available in four colors: black, white, beige and gray
- Mounting hardware is included for all cable management trays

Application Legend

- Ⓛ = Linear Workstations
- 90° = 90° Workstations

		Part number	Width	List price
	Cable Management Tray Ⓛ	RKCMT18	18"	\$35

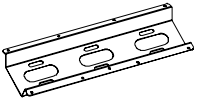
	Cable Management Tray for 90° Workstations 90°	RK90CMT18	18"	\$33
---	---	-----------	-----	------

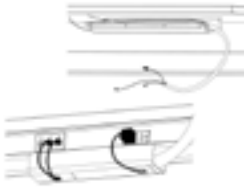
		Part number	Neutral paint/ base price	Accent paint upcharge
	Height Adjustable Cable Management Tray Ⓛ	RKCMTSL	\$181	+\$19

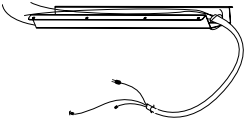
	Height Adjustable Cable Management Tray for 90° Workstations 90°	RK90CMTSL	\$108	+\$22
--	---	-----------	-------	-------

Worksurfaces



US Price List • June 2021



- When manually specifying worksurface in laminate, add suffix “-S” to the code
- These worksurfaces include a small scallop in the center of the back of the surface for cord drop and monitor arm mount
- Core mount brackets included and are available in any of Office Specialty’s standard paint colors
- Depths and widths are nominal
- The wire management gap between the worksurface and the core is 0.562”
- Scallop dimensions are ½”D x 8”W
- Plywood edge option is available
- Cable management trays are ordered separately as needed
- With the exception of the scallop, monitor arms and power modules can be placed anywhere along the back edge of the surface

Application Legend



- Ⓛ = Linear Workstations
- 90° = 90° Workstations

	Part number	Width	Depth	Thickness	Straight edge nuform /laminate/ neutral paint/ base price	Nuform select /pattern	Nuform tapered edge	Grade 1 laminate	Grade 2 laminate	Accent paint upcharge
 24”D Rectangular Worksurface with Small Scallop Ⓛ	RKWS2448	48”	24”	1”	\$552	+\$45	+\$22	+\$135	+\$368	+\$44
	RKWS2454	54”	24”	1”	\$609	+\$51	+\$27	+\$153	+\$374	+\$48
	RKWS2460	60”	24”	1”	\$663	+\$54	+\$30	+\$168	+\$389	+\$53
	RKWS2466	66”	24”	1”	\$682	+\$59	+\$32	+\$184	+\$396	+\$58
	RKWS2472	72”	24”	1”	\$774	+\$65	+\$33	+\$202	+\$401	+\$64
 30”D Rectangular Worksurface with Small Scallop Ⓛ	RKWS3048	48”	30”	1”	\$637	+\$54	+\$30	+\$168	+\$416	+\$53
	RKWS3054	54”	30”	1”	\$700	+\$61	+\$31	+\$189	+\$422	+\$60
	RKWS3060	60”	30”	1”	\$768	+\$67	+\$34	+\$210	+\$424	+\$66
	RKWS3066	66”	30”	1”	\$807	+\$72	+\$37	+\$225	+\$429	+\$71
	RKWS3072	72”	30”	1”	\$898	+\$81	+\$39	+\$251	+\$435	+\$79

- When manually specifying worksurface in laminate, add suffix “-S” to the code
- Cutout worksurfaces which include electrical access do so via a cutout in the back of the worksurface to allow access to the power and data cutout located directly below
- The cutout in the surface lines up with the locations of electrical access in the core
- Core mount brackets included and are available in any of Office Specialty’s standard paint colors
- Depths and widths are nominal
- Monitor arms can be mounted to the left or right of the cutout
- Cable tray with shelf comes with every surface in any of Office Specialty’s standard paint colors
- The wire management gap between the worksurface and the core is 0.562”
- Cutout dimensions are 4”D x 12 – 36”D in 6” increments
- Cable Tray Shelf dimensions are 3¾”D x 12” less than cutout (except for 12” cutouts which use a 5” shelf)
- Plywood edge option is available

Application Legend

- Ⓛ = Linear Workstations
- 90° = 90° Workstations



	Part number	Width	Depth	Thickness	Straight edge nuform classic/ laminate/ neutral paint/ base price	Nuform select /pattern	Nuform tapered edge	Grade 1 laminate	Grade 2 laminate	Accent paint upcharge
 24”D Rectangular Worksurface with Cutout Ⓛ	RKWCO2448	48”	24”	1”	\$663	+\$45	+\$22	+\$135	+\$368	+\$44
	RKWCO2454	54”	24”	1”	\$729	+\$51	+\$27	+\$153	+\$374	+\$48
	RKWCO2460	60”	24”	1”	\$795	+\$54	+\$30	+\$168	+\$389	+\$53
	RKWCO2466	66”	24”	1”	\$818	+\$59	+\$32	+\$184	+\$396	+\$58
	RKWCO2472	72”	24”	1”	\$929	+\$65	+\$33	+\$202	+\$401	+\$64
 30”D Rectangular Worksurface with Cutout Ⓛ	RKWCO3048	48”	30”	1”	\$763	+\$54	+\$30	+\$168	+\$416	+\$53
	RKWCO3054	54”	30”	1”	\$841	+\$61	+\$31	+\$189	+\$422	+\$60
	RKWCO3060	60”	30”	1”	\$922	+\$67	+\$34	+\$210	+\$424	+\$66
	RKWCO3066	66”	30”	1”	\$969	+\$72	+\$37	+\$225	+\$429	+\$71
	RKWCO3072	72”	30”	1”	\$1077	+\$81	+\$39	+\$251	+\$435	+\$79

SkyRockIt Height Adjustable Worksurface

- When manually specifying worksurface in laminate, add suffix “-S” to the code
- The pneumatic SkyRockIt Height Adjustable Worksurfaces come fully ready to be installed and are integrated with the core and legs
- They include the counterbalance mechanism along with a worksurface and may be switched out for a fixed worksurface at any time
- Base mechanism finish options are: black (close match to Onyx paint finish) or white (close match to Simply White paint finish)
- These manual pneumatic height adjustable tables have a lift capacity of max 25 lbs (includes worksurface)
- Height adjustment is 28½” to 40”; a total range of 11½”
- Stretcher bar and core mount brackets included
- Stretcher bar is available in Eco Black paint only
- Brackets are available in any of Office Specialty’s standard paint colors
- Depths and widths are nominal
- Plywood edge option is available
- Can be used in a single sided application
- Surface extends 6” towards the user when raised
- Be aware of accessories on core and hip that will interfere with the function of the raising of surface
- Height Adjustable surfaces have a 1” on all sides to avoid the potential for pinch points when surfaces are raised and lowered
- Optional Height Adjustable Cable Tray can be ordered separately as needed
- SkyRockIt Height Adjustable Worksurface has a scallop on back edge of surface (Scallop dimensions are ½”D x 8”W)
- SkyRockIt Height Adjustable Worksurface for 90° Workstations has no scallop and can only attach to either end of the core, but cannot attach in the middle
- Height Adjustable and fixed height worksurfaces can be used back to back
- In a 90° application, to give the recommended space behind a user, the recommended minimum core length for a 30”d worksurface is 72”

Application Legend

- Ⓛ = Linear Workstations
- 90° = 90° Workstations

	Part number	Width	Depth	Thickness	Straight edge nuform classic/ laminate/ neutral paint/ base price	Nuform select/ pattern	Nuform tapered edge	Grade 1 laminate	Grade 2 laminate	Accent paint upcharge
 SkyRockIt Pneumatic Height Adjustable Worksurface Ⓛ	RKHAW3048	48”	30”	1”	\$1941	+\$54	+\$30	+\$168	+\$396	+\$57
	RKHAW3060	60”	30”	1”	\$2224	+\$67	+\$34	+\$210	+\$403	+\$70
 SkyRockIt Pneumatic Height Adjustable Worksurface for 90° Workstations 90°	RK90HAW3048LH	48”	30”	1”	\$1941	+\$54	+\$77	+\$168	+\$396	+\$57
	RK90HAW3060LH	60”	30”	1”	\$2224	+\$67	+\$88	+\$210	+\$403	+\$70
	Left-handed									
	RK90HAW3048RH	48”	30”	1”	\$1941	+\$54	+\$77	+\$168	+\$396	+\$57
RK90HAW3060RH	60”	30”	1”	\$2224	+\$67	+\$88	+\$210	+\$403	+\$70	
Right-handed										

SkyRockIt Electric Height Adjustable Worksurface

- When manually specifying worksurface in laminate, add suffix “-S” to the code
- The SkyRockIt Electric Height Adjustable Worksurface utilizes a unique single mechanism that is integrated with the core and legs
- It includes an electronic actuator mechanism along with a worksurface
- All supports and housing below the surface are available in any of Office Specialty’s standard paint colors
- The exposed telescoping actuator finish options are: black (close match to Kettle Black paint finish) or white (close match to Simply White paint finish)
- Under surface support bars are available in Eco Black paint only
- These electric height adjustable surfaces have a lift capacity of max 130 lbs (in addition worksurface)
- Height adjustment is 28 ½” to 46”; a total range of 17 ½”
- Depths and widths are nominal
- Plywood edge option is available
- Be aware of accessories on core and hip that overhang and will interfere with the function of the raising of surface
- Height Adjustable surfaces have a 1” gap on all sides to avoid the potential for pinch points when surfaces are raised and lowered
- Cable Chain is included. Available in black only.
- Optional Cable Tray (RK90CMT18) can be ordered separately as needed
- The worksurface has a large scallop on back edge of surface to allow monitor arms to be installed directly left or right of the center mechanism post (Scallop dimensions are ¾”D x 17”W)

- Height Adjustable and fixed height worksurfaces can be used back to back
- UL does not approve the use of the Table Mounted Privacy Screen on the SkyRockIt Electrical Height Adjustable Worksurface
- Can also be used in a single sided or private office application. It is recommended that in these applications a Single Sided Core Mounted Modesty be specified.

Handset Options

Included at no cost:

1. Handset with Up Down Buttons

OR

2. Intuitive Paddle

Optional with upcharge:

3. Handset with Up Down Buttons + Memory Display (+\$92)

OR

4. Intuitive Paddle with Bluetooth + Memory Display (+\$92)

Application Legend

 = Linear Workstations

 = 90° Workstations

	Part number	Width	Depth	Thickness	Straight edge nuform classic/ laminite/ neutral point/ base price	Nuform select/ pattern	Nuform tapered edge	Grade 1 laminite	Grade 2 laminite	Accent point upcharge
--	-------------	-------	-------	-----------	---	------------------------------	---------------------------	---------------------	---------------------	--------------------------

	RKHAE3060	60”	30”	1”	\$2489	+\$67	+\$34	+\$210	+\$403	+\$70
--	-----------	-----	-----	----	--------	-------	-------	--------	--------	-------

SkyRockIt Electric Height Adjustable Worksurface



- When manually specifying worksurface in laminate, add suffix “-S” to the code
- Core mount brackets included and are available in any of Office Specialty’s standard paint colors
- Depths and widths are nominal
- The wire management gap between the worksurface and the core is 0.562”
- Plywood edge option is available
- Cable management trays are ordered separately as needed
- Monitor arms and power modules can be placed anywhere along the back edge of the surface
- All back to back applications must have the same depth worksurfaces
- Height Adjustable and fixed height worksurfaces can be used back to back
- In a 90° application, to give the recommended space behind a user, the recommended minimum core length for a 30”D worksurface is 72”, and for a 24”D worksurface is 60”

Application Legend

- Ⓛ = Linear Workstations
- 90° = 90° Workstations

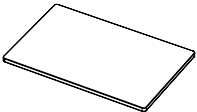
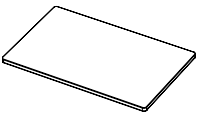
	Part number	Width	Depth	Thickness	Straight edge nuform / laminate / neutral paint / base price	Nuform select / pattern	Nuform tapered edge	Grade 1 laminate	Grade 2 laminate	Accent paint upcharge
 <p>24”D Rectangular Worksurface for 90° Workstations</p> <p>90°</p>	RK90WS2448	48”	24”	1”	\$562	+\$46	+\$23	+\$139	+\$374	+\$46
	RK90WS2454	54”	24”	1”	\$632	+\$51	+\$25	+\$156	+\$422	+\$51
	RK90WS2460	60”	24”	1”	\$670	+\$54	+\$27	+\$165	+\$447	+\$54
	RK90WS2466	66”	24”	1”	\$697	+\$57	+\$29	+\$171	+\$465	+\$57
	RK90WS2472	72”	24”	1”	\$778	+\$63	+\$32	+\$192	+\$519	+\$63
 <p>30”D Rectangular Worksurface for 90° Workstations</p> <p>90°</p>	RK90WS3048	48”	30”	1”	\$638	+\$52	+\$26	+\$157	+\$425	+\$52
	RK90WS3054	54”	30”	1”	\$708	+\$58	+\$29	+\$174	+\$471	+\$58
	RK90WS3060	60”	30”	1”	\$767	+\$62	+\$31	+\$188	+\$511	+\$62
	RK90WS3066	66”	30”	1”	\$810	+\$66	+\$33	+\$199	+\$540	+\$66
	RK90WS3072	72”	30”	1”	\$908	+\$74	+\$36	+\$223	+\$604	+\$74

Storage

US Price List • June 2021



- Taller items in top drawer may interfere with stretcher bar which runs through box drawer
- All Cargo Storage is mounted under-surface
- Drawers and cases are constructed of steel and can be optioned separately in any of Office Specialty's standard paint colors
- Optional locking for box drawers only

For all cargo storage:

- For mounting on fixed surfaces only
- Not compatible with height adjustable worksurfaces
- Push to open slides – push circle to open and close (full extension)













Lock option

Storage drawers come standard with lock. If lock is not required add suffix "/NL" after product number. Deduct \$54 list.

Application Legend

 = Linear Workstations

 = 90° Workstations

							Case	Drawers
		Part number	Width	Height	Depth	Neutral paint/ base price	Accent paint upcharge	Accent paint upcharge
	Cargo Box  	RKCRGOBOX	12"	4"	15 1/2"	\$366	+\$37	+\$37
	Cargo Box/File  	RKCRGOBOXFILE	12"	16"	15 1/2"	\$751	+\$76	+\$76
	Cargo Box/Open  	RKCRGOBOXOPN	12"	16"	15 1/2"	\$463	+\$76	+\$37
	Cargo Open  	RKCRGOOPEN	12"	12 1/2"	15 1/2"	\$246	+\$76	+\$0

- Extension Surface must be specified separately when using Bunker Storage
- The Waste/Recycling Bunker Storage unit accommodates standard small recycling bins; 14 ¾"D x 11 ¼"W x 7 ½"H or smaller
- A laminate or Nuform finish is selected for the center shelf
- Any of Office Specialty's standard paint colors are available for use on the case and brackets

- Bin front colors are optioned separately from the case

Application Legend

 = Linear Workstations

 = 90° Workstations

	Part number	Width	Height	Depth	Nuform classic/ laminate/ neutral paint/ base price	Center Shelf			Case	Bins	Brackets
						Nuform select/ pattern	Grade 1 laminate	Grade 2 laminate	Accent paint upcharge	Accent paint upcharge	Accent paint upcharge
	RKBUNKWASRECY48	48"	12 ½"	15 ½"	\$1454	+\$146	+\$118	+\$234	+\$146	+\$76	+\$39
	RKBUNKWASRECY60	60"	12 ½"	15 ½"	\$1539	+\$155	+\$125	+\$247	+\$155	+\$76	+\$39

Waste/Recycling
Bunker Storage



	Part number	Width	Height	Depth	Nuform classic/ laminate/ neutral paint/ base price	Center Shelf			Case	Brackets
						Nuform select/ pattern	Grade 1 laminate	Grade 2 laminate	Accent paint upcharge	Accent paint upcharge
	RKBUNKOPSHLVS48	48"	12 ½"	15 ½"	\$1190	+\$120	+\$96	+\$192	+\$146	+\$39
	RKBUNKOPSHLVS60	60"	12 ½"	15 ½"	\$1274	+\$128	+\$103	+\$205	+\$155	+\$39

Open Shelf Bunker
Storage



- Pedestals are constructed of steel and can be optioned in any of Office Specialty's standard paint colors
- Optional locking for box drawers only
- Cushion included
- Push to open slides – push circle to open and close (full extension)
- For RK1215-BFM5, front three casters are fixed, rear two casters swivel
- Optional PET Soft Landing available on select pedestals (black only)

Fabric upcharge for mobile (standard) cushion pedestals



Note: To price fabric grade options, add the upcharge (+\$) in the chart below to the base price of the List price (Grade A) column. This will be the total cost for that product.









Grade B/COM	Grade C	Grade D
+\$54	+\$100	+\$141

Lock option

Storage drawers come standard with lock. If lock is not required add suffix "/NL" after product number. Deduct \$54 list.

Application Legend

-  = Linear Workstations
-  = 90° Workstations

							Case	Drawers	
	Part number	Width	Height	Depth	Standard cushion grade A/ neutral paint/ base price	PET Soft Landing upcharge	Accent paint upcharge	Accent paint upcharge	
	Box/Open Mobile Pedestal with cushion  	RK1215-BOM	12"	20 1/2"	15 1/2"	\$735	-\$108	+\$76	+\$37
	Box/File Mobile Pedestal with cushion  	RK1215-BFM5	12"	20 1/2"	15 1/2"	\$983	-\$108	+\$76	+\$76
	Replacement Cushion for Mobile Pedestal  	RKCUSH1215							Grade A/ base price \$266

Accessories

US Price List • June 2021

- The Table Mounted Privacy Screen attaches to the back of a height adjustable worksurface with screws and is tackable
- Brackets included with screen/riser are available in any of Office Specialty's standard paint colors
- Widths for the RKTBMPSxx are nominal
- Screen/riser is slightly shorter in width than worksurface
- These screens/risers are designed to match the Tackable Fabric Riser

- The Surface Mounted Tackable Fabric Riser for 90° Workstations is 16 7/8" above the worksurface and 6" below

Application Legend

- Ⓛ = Linear Workstations
- 90° = 90° Workstations

	Part number	Width	Height	Thickness	Grade A/ neutral paint/ base price	Grade B/ COM	Grade C	Grade D	Accent paint upcharge
	RKTBMPS48	48"	16 7/8"	1/2"	\$602	+\$63	+\$93	+\$216	+\$61
	RKTBMPS60	60"	16 7/8"	1/2"	\$685	+\$69	+\$103	+\$243	+\$70

Table Mounted
Privacy Screen



	RK90RISRTM48	36"	24"	1/2"	\$638	+\$66	+\$97	+\$148	+\$13
	RK90RISRTM54	42"	24"	1/2"	\$746	+\$77	+\$113	+\$173	+\$16
	RK90RISRTM60	48"	24"	1/2"	\$854	+\$88	+\$129	+\$198	+\$18
	RK90RISRTM66	54"	24"	1/2"	\$962	+\$99	+\$145	+\$224	+\$20
	RK90RISRTM72	60"	24"	1/2"	\$1070	+\$110	+\$161	+\$249	+\$22

Table Mounted
Privacy Screen



- When manually specifying worksurface in laminate, add suffix “-S” to the code
- The Extension Surface attaches to the front rail of the Hip by three brackets
- This surface must be specified separately with the bunker storage
- If Bunker storage is needed, the extension surface should be optioned without brackets as storage comes with all brackets needed to connect both the storage and the extension
- Brackets are available in any of Office Specialty’s standard paint colors
- Plywood edge option is available on Extension Surface
- Extension Surface and Bunker are not compatible with Power Pole

- The Accessory Hook mounts to the front rail of the Hip and can be moved along any location of the groove
- Hook is available in any of Office Specialty’s standard paint colors
- The Hipstash is metal and mounted to the hip. It is available in any of Office Specialty’s standard paint colors.

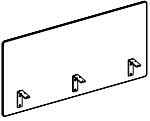
Please refer to the accessory allowance section in the Application Guide for size application details.

Application Legend

- Ⓛ = Linear Workstations
- 90° = 90° Workstations

	Part number	Width	Depth	Thickness	Straight edge nuform classic/ laminate/ neutral paint/ base price	Nuform select /pattern	Nuform tapered edge	Grade 1 laminate	Grade 2 laminate	Accent paint upcharge
--	-------------	-------	-------	-----------	---	---------------------------	---------------------------	---------------------	---------------------	--------------------------



Extension Surface



RKWX1548	48"	15"	1"	\$502	+\$45	+\$22	+\$179	+\$471	+\$51
RKWX1560	60"	15"	1"	\$557	+\$54	+\$30	+\$204	+\$489	+\$57

	Part number	Neutral paint/ base price	Accent paint upcharge
--	-------------	------------------------------	--------------------------



Accessory Hook



RKAHOOK	\$10	+\$3
----------------	------	------

	Part number	Width	Height	Depth	Neutral paint/ base price	Accent paint upcharge
--	-------------	-------	--------	-------	------------------------------	--------------------------

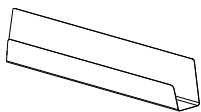

Hipstash



RKHIPSTSH48	48"	13 ½"	5"	\$1048	+\$127
RKHIPSTSH60	60"	13 ½"	5"	\$1129	+\$137

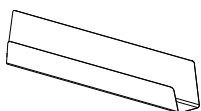

Hipstash for 90°
Workstations





RK90HIPSTSH48	48"	13 ½"	5"	\$1048	+\$127
RK90HIPSTSH60	60"	13 ½"	5"	\$1129	+\$137

- Risers mount to both the slot of the core and the hip
- Riser widths cannot exceed width of the core it's being mounted on
- One Riser max on single sided hips, two accessories max on double hips and 48 – 54" core, three accessories max on 60 – 72" cores
- Gasket from core must be removed, cut to smaller 3" lengths on-site and re-installed with PET riser
- PET Riser is compatible with height adjustable worksurfaces
- Tackable Riser is compatible with height adjustable worksurfaces except when tray is optioned

Please refer to the accessory allowance section in the Application Guide for size application details.

Application Legend

- = Linear Workstations
- = 90° Workstations



	Part number	Width	Height	Thickness	List price
	RKRISRPET1321	18 1/2"	13 1/2"	3/8"	\$123
	RKRISRPET1327	24 1/2"	13 1/2"	3/8"	\$148
	RKRISRPET1336	34 1/8"	13 1/2"	3/8"	\$208
	RKRISRPET1348	46 1/8"	13 1/2"	3/8"	\$295
Hip and Core mount applications					
	RKRISRPET1324	22 1/8"	13 1/2"	3/8"	\$137
	RKRISRPET1330	28 1/8"	13 1/2"	3/8"	\$165
	RKRISRPET1342	40 1/8"	13 1/2"	3/8"	\$268
	RKRISRPET1354	52 1/8"	13 1/2"	3/8"	\$355
	RKRISRPET1360	58 1/8"	13 1/2"	3/8"	\$380
	RKRISRPET1366	64 1/8"	13 1/2"	3/8"	\$415
	RKRISRPET1372	70 1/8"	13 1/2"	3/8"	\$443
Core mount application only					

13 1/2"H PET Riser



17"H Tackable Fabric Riser



	Part number	Width	Height	Thickness	Grade A/ neutral paint/ base price	Grade B/ COM	Grade C	Grade D	Accent paint upcharge	1 tray option	2 tray option
	RKRISRTAC1721	18 1/2"	17"	1/2"	\$396	+\$42	+\$60	+\$92	+\$6	+\$42	+\$81
	RKRISRTAC1727	24 1/2"	17"	1/2"	\$474	+\$49	+\$72	+\$120	+\$7	+\$49	+\$97
	RKRISRTAC1736	34 1/8"	17"	1/2"	\$526	+\$53	+\$80	+\$162	+\$7	+\$53	+\$105
	RKRISRTAC1748	46 1/8"	17"	1/2"	\$619	+\$63	+\$93	+\$216	+\$8	+\$63	+\$126
Hip and Core mount applications											
	RKRISRTAC1724	22 1/8"	17"	1/2"	\$467	+\$48	+\$71	+\$108	+\$7	+\$48	+\$94
	RKRISRTAC1730	28 1/8"	17"	1/2"	\$491	+\$51	+\$76	+\$135	+\$7	+\$49	+\$96
	RKRISRTAC1742	40 1/8"	17"	1/2"	\$571	+\$58	+\$87	+\$191	+\$8	+\$58	+\$115
	RKRISRTAC1754	52 1/8"	17"	1/2"	\$680	+\$69	+\$103	+\$243	+\$9	+\$69	+\$137
	RKRISRTAC1760	58 1/8"	17"	1/2"	\$755	+\$77	+\$115	+\$270	+\$9	+\$77	+\$153
	RKRISRTAC1766	64 1/8"	17"	1/2"	\$799	+\$81	+\$121	+\$296	+\$10	+\$81	+\$160
	RKRISRTAC1772	69 1/8"	17"	1/2"	\$852	+\$86	+\$129	+\$323	+\$10	+\$86	+\$171
Core mount application only											

- Add-On Glazing mounts to both the slot of the core and the hip
- Add-On Glazing widths cannot exceed width of the core it's being mounted on
- One Add-On Glazing max on single sided hips, two accessories max on double hips and 48 – 54” core, three accessories max on 60 – 72” cores
- Compatible with height adjustable worksurfaces

Please refer to the accessory allowance section in the Application Guide for size application details.

Application Legend

 = Linear Workstations

 = 90° Workstations

	Part number	Width	Height	Thickness	Clear glass/ base price	Etched 1 side	Etched 2 side	Gray	Laminate glass
	RKRISRAOG1321	18 1/2"	13 1/2"	1/4"	\$84	+\$65	+\$178	+\$54	—
	RKRISRAOG1327	24 1/2"	13 1/2"	1/4"	\$90	+\$76	+\$193	+\$66	+\$191
	RKRISRAOG1336	34 1/8"	13 1/2"	1/4"	\$101	+\$90	+\$226	+\$77	+\$237
	RKRISRAOG1348	46 1/8"	13 1/2"	1/4"	\$131	+\$114	+\$303	+\$89	+\$314

13 1/2”H Add-On Glazing



Hip and Core mount applications

RKRISRAOG1324	22 1/8"	13 1/2"	1/4"	\$88	+\$67	+\$184	+\$60	—
RKRISRAOG1330	28 1/8"	13 1/2"	1/4"	\$90	+\$85	+\$211	+\$70	+\$196
RKRISRAOG1342	40 1/8"	13 1/2"	1/4"	\$114	+\$101	+\$267	+\$81	+\$278
RKRISRAOG1354	52 1/8"	13 1/2"	1/4"	\$142	+\$131	+\$344	+\$94	+\$355
RKRISRAOG1360	58 1/8"	13 1/2"	1/4"	\$160	+\$142	+\$380	+\$100	+\$390
RKRISRAOG1366	64 1/8"	13 1/2"	1/4"	\$172	+\$160	+\$421	+\$105	+\$431
RKRISRAOG1372	69 1/8"	13 1/2"	1/4"	\$191	+\$172	+\$462	+\$111	+\$462

Core mount application only



17”H Add-On Glazing



RKRISRAOG1721	18 1/2"	17"	1/4"	\$96	+\$74	+\$201	+\$61	—
RKRISRAOG1727	24 1/2"	17"	1/4"	\$103	+\$86	+\$216	+\$76	+\$214
RKRISRAOG1736	34 1/8"	17"	1/4"	\$117	+\$101	+\$254	+\$87	+\$268
RKRISRAOG1748	46 1/8"	17"	1/4"	\$151	+\$128	+\$342	+\$100	+\$355

Hip and Core mount applications

RKRISRAOG1724	22 1/8"	17"	1/4"	\$101	+\$77	+\$208	+\$67	+\$184
RKRISRAOG1730	28 1/8"	17"	1/4"	\$112	+\$96	+\$239	+\$79	+\$221
RKRISRAOG1742	40 1/8"	17"	1/4"	\$130	+\$115	+\$302	+\$91	+\$314
RKRISRAOG1754	52 1/8"	17"	1/4"	\$164	+\$147	+\$388	+\$106	+\$400
RKRISRAOG1760	58 1/8"	17"	1/4"	\$184	+\$161	+\$428	+\$114	+\$441
RKRISRAOG1766	64 1/8"	17"	1/4"	\$198	+\$181	+\$475	+\$119	+\$489
RKRISRAOG1772	69 1/8"	17"	1/4"	\$218	+\$195	+\$522	+\$126	+\$522

Core mount application only

- Risers mount to both the slot of the core and the hip
- Riser widths cannot exceed width of the core it's being mounted on
- One Riser max on single sided hips, two accessories max on double hips and 48 – 54" core, three accessories max on 60 – 72" cores
- Compatible with height adjustable worksurfaces

Please refer to the accessory allowance section in the Application Guide for size application details.

Application Legend

- Ⓛ = Linear Workstations
- 90° = 90° Workstations

	Part number	Width	Height	Thickness	Laminate/ base price	Grade 1 laminate	Grade 2 laminate
 <p>17"H Laminate Riser</p> <p>Ⓛ 90°</p>	RKRISRLAM1721	18 1/2"	17"	1/2"	\$264	+\$27	+\$53
	RKRISRLAM1727	24 1/2"	17"	1/2"	\$314	+\$32	+\$63
	RKRISRLAM1736	34 1/8"	17"	1/2"	\$415	+\$43	+\$84
	RKRISRLAM1748	46 1/8"	17"	1/2"	\$533	+\$54	+\$107
Hip and Core mount applications							
	RKRISRLAM1724	22 1/8"	17"	1/2"	\$295	+\$31	+\$60
	RKRISRLAM1730	28 1/8"	17"	1/2"	\$324	+\$33	+\$65
	RKRISRLAM1742	40 1/8"	17"	1/2"	\$485	+\$50	+\$98
	RKRISRLAM1754	52 1/8"	17"	1/2"	\$562	+\$57	+\$114
	RKRISRLAM1760	58 1/8"	17"	1/2"	\$590	+\$60	+\$119
	RKRISRLAM1766	64 1/8"	17"	1/2"	\$651	+\$65	+\$131
	RKRISRLAM1772	69 1/8"	17"	1/2"	\$697	+\$71	+\$140
Core mount application only							

- Launch Pad trays are steel constructed and available in any of Office Specialty's standard paint colors
- Low Wall Launch Pad widths cannot exceed width of core it is being mounted on
- Upmount Bulkhead is constructed of steel (casing) and laminate (top and divider) construction with optional two PET tackboards or two whiteboards (cannot combine) for reverse sides of openings and are available in a back-to-back configuration only
- Upmount Mini Bulkhead is constructed of steel (casing) and laminate (top and divider) construction and are available in a back-to-back (middle) or single sided (end) configurations
- Upmount Mini Bulkhead widths cannot exceed width of the spine it is being mounted on

For all groove mounted accessory trays:



- All groove mounted accessory trays can be moved by the user
- One accessory max on single sided hips, two accessories max on double hips and 48 - 54" core, three accessories max on 60 - 72" cores
- Cannot be used where front slot trays are present
- Not compatible with height adjustable worksurfaces



Please refer to the accessory allowance section in the Application Guide for size application details.

Application Legend

 = Linear Workstations

 = 90° Workstations

	Part number	Width	Height	Depth	Neutral paint/ base price	Accent paint upcharge	
 <p>Low Wall Launch Pad  </p>	RKGMPADLW18	18"	1 1/2"	8"	\$191	+\$20	
	RKGMPADLW36	34 1/8"	1 1/2"	8"	\$254	+\$26	
	Hip and Core mount applications						
	RKGMPADLW30	28 1/8"	1 1/2"	8"	\$237	+\$24	
	RKGMPADLW48	46 1/8"	1 1/2"	8"	\$269	+\$27	
	RKGMPADLW60	58 1/8"	1 1/2"	8"	\$295	+\$31	
Core mount application only							

	Part number	Width	Height	Depth	Neutral paint/ base price	Accent paint upcharge
 <p>High Wall Launch Pad  </p>	RKGMPADHW18	18"	5"	8"	\$228	+\$23
Hip and Core mount applications						

	Part number	Width	Height	Depth	Laminate/ neutral paint/ base price	For Top		For Divider		Optional white- boards	Optional tackboards	Accent paint upcharge
						Grade 1 laminates	Grade 2 laminates	Grade 1 laminates	Grade 2 laminates			
 <p>RockIt Upmount Bulkhead  </p>	RKBULK30	28 1/8"	13 1/2"	8"	\$1186	+\$60	+\$120	+\$60	+\$120	+\$106	+\$279	+\$120
	RKBULK36	34 1/8"	13 1/2"	8"	\$1321	+\$66	+\$133	+\$66	+\$133	+\$112	+\$302	+\$133
	RKBULK48	46 1/8"	13 1/2"	8"	\$1457	+\$73	+\$146	+\$73	+\$146	+\$118	+\$323	+\$146
	RKBULK60	58 1/8"	13 1/2"	8"	\$1592	+\$81	+\$160	+\$81	+\$160	+\$124	+\$346	+\$160
Core mount application only												

- Upmount Mini Bulkhead is constructed of steel (casing) and laminate (top and divider) construction and are available in a back-to-back (middle) or single sided (end) configurations
- Upmount Mini Bulkhead widths cannot exceed width of the core it's being mounted on
- Upmount Planters are steel constructed and available in any of Office Specialty's standard paint colors with a black plastic insert included
- Upmount Planter widths cannot exceed width of the core it's being mounted on
- Upmount Planter can only be used with height adjustable worksurfaces on the core, NOT hip

For all groove mounted accessory trays:

- All groove mounted accessory trays can be moved by the user
- One accessory max on single sided hips, two accessories max on double hips and 48 – 54" core, three accessories max on 60 – 72" cores
- Cannot be used where front slot trays are present
- Not compatible with height adjustable worksurfaces

Please refer to the accessory allowance section in the Application Guide for size application details.

Application Legend

- Ⓛ = Linear Workstations
- 90° = 90° Workstations

	Part number	Width	Height	Depth	Laminate/ neutral paint/ base price	For Top		For Divider		Accent paint upcharge
						Grade 1 laminate	Grade 2 laminate	Grade 1 laminate	Grade 2 laminate	
	RKMNIBULK18	16 1/8"	6"	12"	\$889	+\$46	+\$90	+\$46	+\$90	+\$90
	RKMNIBULK36	34 1/8"	6"	12"	\$1195	+\$61	+\$120	+\$61	+\$120	+\$120
	RKMNIBULK48	46 1/8"	6"	12"	\$1338	+\$67	+\$134	+\$67	+\$134	+\$134
Hip and Core mount applications										
RockIt Upmount Mini Bulkhead Middle Unit illustrated Ⓛ 90°	RKMNIBULK30	28 1/8"	6"	12"	\$1053	+\$53	+\$106	+\$53	+\$106	+\$106
Core mount application only										

	Part number	Width	Height	Depth	Neutral paint/ base price	Accent paint upcharge
	RKPLNT36	34.7"	10 1/8"	4 3/4"	\$494	+\$50
	RKPLNT48	46.7"	10 1/8"	4 3/4"	\$591	+\$60
	Hip and Core mount applications					
RockIt Upmount Planter Ⓛ 90°	RKPLNT30	28.7"	10 1/8"	4 3/4"	\$396	+\$42
	RKPLNT60	58.7"	10 1/8"	4 3/4"	\$692	+\$70
Core mount application only						

- The Core Mounted Stash is mounted to the core in a 90° application and includes a felt pad on the upper shelf
- The Core Mounted Stash typically mounts overtop electrical receptical with access for power cords

****338 Dark Bronze is not recommend for use on the Stacker Launch Pad. Please select any of the other Office Specialty standard paint colors. If 338 Dark Bronze must be specified, a waiver must be signed and returned. Please contact your regional Sales Resource Team member for details.**

For all core front rail accessories:











- Specific positions for mounting due to work surface brackets and power access; on the left or right side of the surface
- Middle location is possible only on scalloped worksurfaces 60" or wider
- Two accessories max on 48 – 54" core, three accessories max on 60 – 72" cores
- Not compatible with height adjustable worksurfaces
- All core front rail accessories cannot be moved by the user

Please refer to the accessory allowance section in the Application Guide for size application details.

Application Legend

 = Linear Workstations

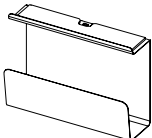
 = 90° Workstations

		Part number	Width	Height	Depth	Neutral paint/ base price	Accent paint upcharge
	Stacker Launch Pad**  	RKRAILPADSTKR13**	12 ½"	5"	9 ¼"	\$267	+\$27
	Low Wall Launch Pad  	RKRAILPADLW18	18"	—	5"	\$197	+\$21
	High Wall Launch Pad  	RKRAILPADHW18	18"	—	9"	\$204	+\$21
	Core Mounted Stash for 90° workstations 	RK90CORESTSH	18"	12 ½"	5"	\$476	+\$58



- Single and Double Sided Modesty Panels are partial height and mount to the core
- Bottom of all modesty panels lines up with the bottom of the Leg Hip Support Modesty
- Widths are nominal for Single Sided Modesty Panels



Please refer to the accessory allowance section in the Application Guide for size application details.



Application Legend



 = Linear Workstations

 = 90° Workstations

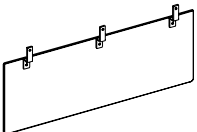
	Part number	Width	Height	List price
 <p>PET Single Sided Core Mounted Modesty Panel</p> <p> </p>	RKSSMODPNLPT48	48"	13 1/2"	\$309
	RKSSMODPNLPT54	54"	13 1/2"	\$456
	RKSSMODPNLPT60	60"	13 1/2"	\$604
	RKSSMODPNLPT66	66"	13 1/2"	\$751
	RKSSMODPNLPT72	72"	13 1/2"	\$899

	Part number	Width	Height	Laminate/ base price	Grade 1 laminate	Grade 2 laminate
 <p>Laminate Single Sided Core Mounted Modesty Panel</p> <p> </p>	RKSSMODPNLLM48	48"	13 1/2"	\$415	+\$43	+\$84
	RKSSMODPNLLM54	54"	13 1/2"	\$466	+\$48	+\$94
	RKSSMODPNLLM60	60"	13 1/2"	\$517	+\$52	+\$104
	RKSSMODPNLLM66	66"	13 1/2"	\$567	+\$58	+\$115
	RKSSMODPNLLM72	72"	13 1/2"	\$618	+\$64	+\$125

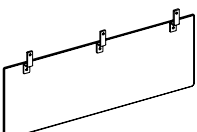
	Part number	Width	Height	Neutral paint/ base price	Accent paint upcharge
 <p>PET Double Sided Core Mounted Modesty Panel</p> <p> </p>	RKBBMDPET48	34"	13 1/2"	\$216	+\$18
	RKBBMDPET54	40"	13 1/2"	\$260	+\$22
	RKBBMDPET60	46"	13 1/2"	\$281	+\$23
	RKBBMDPET66	52"	13 1/2"	\$411	+\$34
	RKBBMDPET72	58"	13 1/2"	\$432	+\$35

	Part number	Width	Height	Neutral paint/ laminate/ base price	Grade 1 laminate	Grade 2 laminate	Accent paint upcharge
 <p>Laminate Double Sided Core Mounted Modesty Panel</p> <p> </p>	RKBBMDLAM48	34"	13 1/2"	\$415	+\$44	+\$63	+\$34
	RKBBMDLAM54	40"	13 1/2"	\$466	+\$48	+\$71	+\$18
	RKBBMDLAM60	46"	13 1/2"	\$517	+\$53	+\$78	+\$43
	RKBBMDLAM66	52"	13 1/2"	\$567	+\$59	+\$86	+\$46
	RKBBMDLAM72	58"	13 1/2"	\$618	+\$64	+\$94	+\$50

- Bottom of all modesty panels lines up with the bottom of the Leg Hip Support Modesty
 - Leg Hip Support Modesty panel is mounted to the Leg Hip and provides modesty below the surface. Sizes are specific to the width of the leg.
 - Leg Hip Support Modesty panel is for end applications only and cannot be used when Bunkers are present. Includes a gasket in structure.
 - Leg Hip Support Modesty Panel is not recommended for use with power pole, due to precise field cutting required
 - The Table Mounted Modesty Panel for 90° Workstations is mounted to the underside of the worksurface
- Please refer to the accessory allowance section in the Application Guide for size application details.**
- Application Legend**
- Ⓛ = Linear Workstations
90° = 90° Workstations

	Part number	Width	Height	Thickness	List price
 <p>PET Leg Hip Support Modesty End Application Ⓛ</p>	RKLEGMDP24	24"	13 ½"	½"	\$142
	RKLEGMDP30	30"	13 ½"	½"	\$269
	RKLEGMDP48	48"	13 ½"	½"	\$395
	RKLEGMDP60	60"	13 ½"	½"	\$519

	Part number	Width	Height	Thickness	Laminate/ base price	Grade 1 laminate	Grade 2 laminate
 <p>Laminate Leg Hip Support Modesty End Application Ⓛ</p>	RKLEGMDLAM24	24"	13 ½"	½"	\$223	+\$63	+\$46
	RKLEGMDLAM30	30"	13 ½"	½"	\$347	+\$35	+\$70
	RKLEGMDLAM48	48"	13 ½"	½"	\$488	+\$50	+\$98
	RKLEGMDLAM60	60"	13 ½"	½"	\$627	+\$63	+\$127

	Part number	Width	Height	List price
 <p>PET Table Mounted Modesty Panel for 90° Workstations 90°</p>	RK90MPTMPET48	34"	13 ½"	\$309
	RK90MPTMPET54	40"	13 ½"	\$456
	RK90MPTMPET60	46"	13 ½"	\$604
	RK90MPTMPET66	52"	13 ½"	\$751
	RK90MPTMPET72	58"	13 ½"	\$899

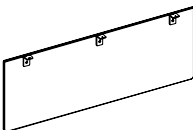
	Part number	Width	Height	Laminate/ base price	Grade 1 laminate	Grade 2 laminate
 <p>Laminate Table Mounted Modesty Panel for 90° Workstations 90°</p>	RK90MPTMLAM48	34"	13 ½"	\$415	+\$43	+\$84
	RK90MPTMLAM54	40"	13 ½"	\$466	+\$48	+\$94
	RK90MPTMLAM60	46"	13 ½"	\$517	+\$52	+\$104
	RK90MPTMLAM66	52"	13 ½"	\$567	+\$58	+\$115
	RK90MPTMLAM72	58"	13 ½"	\$618	+\$63	+\$125



67 Toll Road
Holland Landing
Ontario, Canada
L9N 1H2

T 905 836 7676
F 905 836 6000

officespecialty.com