

System | Bench | Tables

US Price List

June 2021

NCPA Contract # 05-57



inscape

work for tomorrow

Conditions of Sale

Refer to the Conditions of Sale document on the [Support](#) page of [myinscape.com](#).

System

| | | | |
|----------------------------------|-----------|--|-----------|
| Architecture | 10 | | |
| <hr/> | | | |
| Frames and Screens | 11 | | |
| General Information | 11 | | |
| 3 ½" Thick | 13 | | |
| – Standard Frames | 13 | | |
| – Basic Frames | 15 | | |
| – Stack-on Frames | 17 | | |
| – Double Glazed Stack-on Frames | 18 | | |
| 2 ¾" Thick | 19 | | |
| – Standard Frames | 19 | | |
| – Basic Frames | 21 | | |
| – Stack-on Frames | 23 | | |
| – Double Glazed Stack-on Frames | 24 | | |
| 1 ½" Thick | 25 | | |
| – Segmented Screens | 25 | | |
| – Glazed Segmented Screens | 26 | | |
| – Monolithic Screens | 27 | | |
| – Accessory Screens | 29 | | |
| – Freestanding Screens | 30 | | |
| – Table Mounted Screens | 31 | | |
| Sliding Doors | 32 | | |
| Connectors and Trim | 33 | | |
| General Information | 33 | | |
| 3 ½" Thick | 35 | | |
| – Trim | 35 | | |
| – 90° Connector Kits | 36 | | |
| – 90° Same Height Connector Kits | 37 | | |
| – 90° Stack-on Connector Kits | 38 | | |
| – 120° Connector Kits | 39 | | |
| 2 ¾" Thick Trim | 40 | | |
| – 90° Connector Kits | 41 | | |
| – 90° Same Height Connector Kits | 42 | | |
| – 90° Stack-on Connector Kits | 43 | | |
| – 120° Connector Kits | 44 | | |
| – Screen Connectors | 45 | | |
| | | 1 ½" Screen to 3 ½" Frame Connector Kits | 46 |
| | | 1 ½" Screen to 3 ½" Frame Connector Kits | 47 |
| | | 2 ¾" Frame to 3 ½" Frame Same | |
| | | Height Connector Kits | 48 |
| | | Planna Storage Benching End Trim | 49 |
| | | Tiles | 50 |
| | | General Information | 50 |
| | | Painted | 53 |
| | | Fabric | 55 |
| | | Tackable | 57 |
| | | Nuform | 58 |
| | | Nuform Patterned | 59 |
| | | Whiteboard | 60 |
| | | Paper Management | 61 |
| | | Paper Management Tile Reinforcing Kit | 62 |
| | | Perforated | 63 |
| | | Communication - Painted | 64 |
| | | Communication - Fabric | 65 |
| | | Multi Access - Painted | 67 |
| | | Multi Access - Fabric | 68 |
| | | Double Glazed | 69 |
| | | Monolithic - Painted | 70 |
| | | Monolithic - Fabric | 71 |
| | | Planna Storage Benching Multi Access | 72 |
| | | Foam Bumper | 73 |

System

Technology 74

| | | | |
|-------------------------------|-----------|--|-----------|
| General Information | 75 | Jumper Cables | 86 |
| Power In Feeds | 80 | Receptacles | 87 |
| Floor/Wall | 80 | USB Power Modules | 88 |
| Ceiling Power Pole Kits | 81 | Task Lights | 89 |
| Chimney Power Feed Frame | 82 | Data Components | 90 |
| Frame Components | 83 | Clamp On Power & Data Modules | 91 |
| Chicago Electrical Components | 83 | Clamp On Power & Data Modules | 92 |
| Beltline Cover Kits | 84 | | |
| Power Tracks | 85 | | |

Worksurfaces & Supports 93

| | | | |
|-----------------------------------|-----------|---|------------|
| Panel Mounted Worksurfaces | 94 | Transaction tops | 110 |
| General Information | 94 | General Information | 110 |
| Rectangular Tops | 96 | For 3 ½" Thick Frames | 111 |
| 90° Rectangular Tops | 98 | For 2 ¾" Thick Frames | 112 |
| True Sized Rectangular Tops | 99 | Supports | 113 |
| Reducing Tops | 100 | General Information | 113 |
| Saddle Tops | 101 | Panel Mounted Worksurface Supports | 115 |
| 90° Saddle Tops | 102 | Worksurface Supports | 119 |
| Galley Tops | 103 | Planna Worksurface Support Brackets | 120 |
| Standard Corners | 104 | Legs and Leg Docking Brackets | 121 |
| Extended Corners | 105 | 1 ½" Screen Worksurfaces Docking Brackets | 123 |
| 120° Corners | 108 | | |
| Conference Tops | 109 | | |

System

| | | | |
|-------------------------------|------------|---|------------|
| Storage | 124 | | |
| Lock locations | 125 | Storage Bin Brackets | 160 |
| Pedestals | 127 | Up-Mount Bin Supports and Brackets | 161 |
| General Information | 127 | Shelves + Brackets | 162 |
| Storage with Handles | 130 | Up-Mount Bin Accessories | 163 |
| 9900 Series Front | 132 | Twin-Bins | 165 |
| Nuform Front | 135 | Twin-Bin Brackets | 166 |
| Pedestal Brackets | 136 | Twin-Bin Accessories | 167 |
| Laterals | 138 | Pianna Storage | 168 |
| General Information | 138 | General Information | 168 |
| Storage with Handles | 141 | Base Modules | 170 |
| 9900 Series Front | 142 | Sliding Doors | 175 |
| Nuform Front | 144 | Benching End Trim | 176 |
| Lateral Brackets | 145 | Laminate Storage | 177 |
| Towers | 147 | General Information | 177 |
| General Information | 147 | Pedestals | 179 |
| 9900 Series Front | 149 | Laterals | 180 |
| Nuform Front | 152 | Open Bookcases | 181 |
| Overhead Storage | 155 | Combination Bookcase/Laterals | 182 |
| General Information | 155 | Hinged Door Cabinets | 183 |
| Storage Bins | 158 | Overhead Bins + Shelves | 184 |
| Hinged Door and Up-Mount Bins | 159 | Manhattan Tower | 185 |
| | | Accessories | 186 |
| Accessories | 190 | | |
| General Information | 191 | Electrified Twin-Bin | 212 |
| Horizontal | 195 | Twin Bin | 213 |
| Panel and Table | 196 | Pedestal | 214 |
| Modesty Panel | 199 | Lateral | 215 |
| Privacy Screens | 202 | Back Painted Glass | 218 |
| Add-on Glazing | 204 | SuperStor™ | 219 |
| 3 ½" T | 204 | Cushions | 220 |
| 2 ¾" T | 206 | Pianna Storage | 222 |
| Wall Mounted | 208 | Brackets and Rails | 222 |
| Storage | 210 | Pedestals and Lateral Tops | 223 |
| Overhead Storage | 211 | Tops to Accommodate Benching Electrical | 225 |

Bench

| | | | |
|--------------------------------------|------------|--|------------|
| Architecture | 227 | | |
| General Information | 228 | Connectors and Trim | 238 |
| Spines | 231 | Tiles | 241 |
| Spine Frames | 231 | Full Height Spine Tiles | 241 |
| Stack-on Frames | 232 | Partial Height Spine Tiles | 242 |
| Spine Support Legs | 234 | 10.125" H Stack-On Tiles | 246 |
| Technology | 248 | | |
| General Information | 249 | Data Components | 255 |
| Power In Feeds | 252 | Power and Data Accessories | 256 |
| Electrical Components | 253 | Clamp On Power & Data Modules | 257 |
| Worksurfaces & Supports | 258 | | |
| General Information | 259 | Worksurfaces Supports | 274 |
| Rectangular Tops | 262 | 90° Application | 276 |
| Middle Application | 262 | Parallel Application | 278 |
| Full End Gable Application | 263 | Full Gable | 280 |
| Open End Leg Application | 264 | Full Gable Brackets | 283 |
| End Storage Application | 265 | Open A Leg | 284 |
| 90° worksurface | 266 | Open H Leg | 286 |
| 120° Worksurface | 267 | Open O Leg | 288 |
| Middle Application | 267 | For Electric Height Adjustable | |
| Full End Gable Application | 268 | Application Only | 289 |
| Open End Leg Application | 270 | | |
| Height Adjustable Worksurface | 272 | | |
| Electric | 272 | | |

Bench

| | | | |
|-----------------------------|------------|---|------------|
| Storage | 290 | | |
| General Information | 291 | 9900 Series Front | 297 |
| 9900 Series Front | 295 | Bookcases | 298 |
| Laterals | 296 | Twin-Bins and Brackets | 299 |
| Storage with Handles | 296 | | |
| Accessories | 301 | | |
| General Information | 302 | Hang-On Accessories | 317 |
| Spine Accessories | 304 | Worksurface Screens for 90° Workstations | 318 |
| Transaction Tops | 305 | Worksurface Undermount | 320 |
| Up-Mount Bins | 306 | Replacement Fabric Skins | 321 |
| Upmont Shelves | 308 | | |
| Add-on Glazing | 309 | | |
| Spine Dividers | 311 | | |
| Open leg Accessories | 313 | | |
| Worksurface Dividers | 315 | | |

Tables

| | | | |
|-------------------|-----|--|--|
| Tables Collection | 324 | | |
|-------------------|-----|--|--|

| | | | |
|-------------------------------|------------|----------------------|------------|
| Standing Height Tables | 325 | Coffee Tables | 330 |
| Meeting Tables | 327 | | |

| | | | |
|--------------|-----|--|--|
| Worksurfaces | 331 | | |
|--------------|-----|--|--|

| | | | |
|------------------------------------|------------|---|------------|
| Square and Rectangular Tops | 332 | Trapezoid Tops | 337 |
| Racetrack and Boat Tops | 333 | Hex, Pebble and Rhombus Tops | 338 |
| Round Tops | 334 | Rectangular Tops with Power Module | 339 |
| Semi-circle Tops | 335 | Bullet, Bean, Oval and Curved | |
| Quarter-circle Tops | 336 | Rectangular Tops | 340 |

| | | | |
|--------------|-----|--|--|
| Legs & Bases | 341 | | |
|--------------|-----|--|--|

| | | | |
|-------------|------------|--------------|------------|
| Legs | 342 | Bases | 345 |
|-------------|------------|--------------|------------|

| | | | |
|-------------|-----|--|--|
| Accessories | 346 | | |
|-------------|-----|--|--|

| | | | |
|------------------------------------|------------|-------------------------------|------------|
| Surface Support Accessories | 347 | Modesty Panels | 349 |
| Table Mounted Screens | 348 | Electrical Accessories | 353 |

Finishes 356

Care & Maintenance 383

Transit Times 386

System US Price List

June 2021

inscape

work for tomorrow

System Architecture

inscape

work for tomorrow

Inscape System frames are constructed of 16 gauge tubular steel uprights with welded 18 gauge steel crossrails. This strong yet lightweight construction provides ease of movement and reconfiguration.

The simplicity of the frame structure provides an intelligent solution to cable management. The absence of baseplates, apertures and corner posts eliminate barriers that restrict the routing of cables. Cabling may be routed both vertically and horizontally through the panel. Cables are laid into cable managers that easily install between panel crossrails throughout the framework. Cable managers safely cradle and segregate cables. An aperture free system means installation and reconfiguration costs are kept to a minimum. Cabling may also enter the system through the top or face of the panel. Reconfiguration is easy and economical. Cabling simply eases out of the cable managers and is laid back in at the desired point, eliminating the costly need to cut and re-terminate cables for every reconfiguration. Panels do not have creep.

3 1/2" THICK FRAME

The 3 1/2" Thick Frame accommodates approximately 96 Cat6 or 125 Cat5 cables per 13.5" H zone at a fill capacity of 60% between the upright and the tile. Frames and frame specific components for the 3.5" thick frame are denoted by the suffix "-3F".

2 3/4" THICK FRAME

The 2 3/4" Thick Frame accommodates approximately 52 Cat6 or 67 Cat5 cables per 13.5" H zone at a fill capacity of 60% between the upright and the tile. Frames and frame specific components for the 2.75" thick frame are denoted by the suffix "-2F".

STANDARD FRAMES

A Standard Frame has a beltline cover kit enabling power to run at the beltline location without the need of a "cutout" tile. Standard frames are available for both the 3.5" and 2.75" thick frames. Frames 37" H and higher come equipped with one wire manager. Electrical and data components must be specified separately. Standard heights that are available include 37", 44", 51", 57" and 64".

NOTE: Tiles cannot be placed over the cover kit on a 2 3/4" thick frame. The Cover Kit frame clip cannot accommodate a tile hanging from the clip.
NOTE: 27" H tiles cannot be mounted in bottom position on a 2 3/4" thick standard frame.

BASIC FRAMES

Basic Frames do not include the electrical cover kit but may house power which is to be accessed at all locations with a "cutout" tile. Basic frames 37" H and higher come with one wire manager. Basic frames are available for both the 3.5" and 2.75" thick frames. Basic heights available include 24", 29", 37", 44", 51", 57" and 64". The 3 1/2" thick frame by 24" H includes the mounting hardware to attach to a Credenza Storage case when used in a benching application.

Both types of frames feature glides that provide 1 1/2" height adjustment allowing air to circulate under panels and throughout the office. Frames are available in 6" increments in widths ranging from 18" W to 60" W.

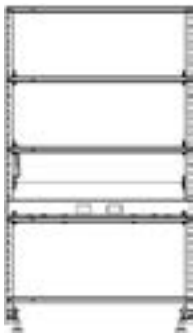

Standard Frames



Basic Frames

STACK ON FRAME

The Stack on Frame consists of a 6.75", 13.5", 20.25" and 27" frame which may be installed on a Standard or Basic frame of the same width or combination of two frames as outlined in the Inscape System Application Guide only. The Stack on frame is load bearing to one storage unit above 64" H and may be stacked up to 91" H. Tiles and trim are specified separately. The top cap from the base frame may be used on the stack on frame. Stack on frames are frame thickness specific and should be specified accordingly.

DOUBLE GLAZED STACK-ON KIT

Double Glazed Stack-On Kit is a stack on frame with a double glazed insert. The 24" to 60" W Double Glazed Stack is a fully welded frame stack on. Double Glazed Stacks which are 54" and wider are kitted and are installed on site. The Double Glazed Stack on is not load bearing and no stacks can be stacked on top of the Double Glaze. Stack on frames are frame thickness specific and should be specified accordingly. Finishes are available in Clear or Frosted Acrylic to match Double Glazed tile.

| | | Dimensions | | | |
|----------------|---------|---------------------|-------------------------|-----------------------|---------------------|
| | | A | B | C | D |
| SYSTEM | TRIM | TOP CAP TO TOP TILE | TOP TILE TO BOTTOM TILE | BOTTOM TILE TO FLOOR* | FLOOR TO CANTILEVER |
| INSCAPE SYSTEM | Tapered | 1.1 | 24" h = 20.050 | 1.843 | 27.24 |
| | | | 29" h = 26.800 | | |
| | Flat | 0.65 | 37" h = 33.550 | | |
| | | | 44" h = 40.300 | | |
| | | | 51" h = 47.050 | | |
| | | | 57" h = 53.800 | | |
| | | | 64" h = 60.550 | | |



Note: Dimensions 'C' & 'D' measured with frames at lowest glide position. Frame can be raised up to 1.500" depending on configuration and leveling.

1 1/2" THICK SCREEN

The 1.5" Thick Screen is available in a freestanding version or one that is intended to be joined to adjacent screens. The screen is inclusive of a finished frame, 1/2" tackable core (fabric option) and glides. Various configurations of the segmented or monolithic screen are available including all fabric, fabric with acrylic or resin and polycarbonate. Whiteboard accessories should follow the same guidelines as the Whiteboard tile. No assembly is required with the screen.

TABLE MOUNTED SCREEN

The Table Mounted Screen is constructed of a 1.5" thick extruded aluminum frame and is designed to provide modesty and privacy to adjacent work areas. This 37" H screen mounts onto a 1" or 1.25" thick worksurface and may be adjusted vertically to create the desired privacy or modesty. The tackable 1/2" thick core may be specified in any of Inscape's standard fabrics or COM. Height adjustable brackets allow for various screen height positions. It is recommended that the table mounted screen be installed 20" above the surface with 16" below. Table mounted screens cannot be attached to 1.5" thick screen brackets attaching to thicker frames.

1 1/2" ELECTRIFIED STORAGE FRAME

The 1.5" Electrified Storage Frame is an open structure frame which is positioned between Electrified Storage units to allow technology to run through when a 1 1/2" connection is required and a 1 1/2" screen is to run perpendicular to Electrified Storage spine.



INSCAPE SYSTEM SLIDING DOOR

Inscape System Sliding Door is a 1 1/2" thick extruded aluminum frame which is available to match 51" and 64" panel heights and openings of 36" and 42". The sliding door includes a door assembly consisting of door trim, polycarbonate panel, two door pulls, two 2.5" adjustable wheels and top/bottom connector brackets to attach to the panel frame. A locking version is available and is secured in the closed position by a lock at the opposite side of the handle. Polycarbonate has naturally occurring variations in the material. The tile configuration must be such that the crossrail at 37" H is accessible where the lock mechanism is located. See Inscape System Application Guide.

The 36" W sliding door is installed on any panel or combination of panels 42" in width.

The 42" W sliding door is installed on any panel or combination of panels 48" in width.

Sliding Doors are handed and need to be specified left or right for the direction in which the door is required to slide once installed on the front of the workstation.

GENERAL INFORMATION

To facilitate specification of connector kits for various multi-height panel configurations, preconfigured connector kits have been created. Connector kits include all the vertical trims, connectors, plugs and plates required to make and complete the connection at the junction point.

The panel configurations shown on the following pages have been grouped according to the type of connection: 'L' Connection (two-way 90°), 'T' Connection (three-way 90°), 'X' Connection (four-way 90°), 'V' Connection (two-way 120°) and 'Y' Connection (three-way 120°). Identify the desired connection and panel configuration and specify connectors as outlined below. A variety of panel configurations are shown on the following pages. Some configurations have more than one product code. An explanation of the product codes follow:

PRODUCT CODE KEY EXAMPLE

INCPT5053

| | |
|-------------|----------------------|
| INCP | panel connector |
| T | three-way connection |
| 5 | 51" H panel |
| 0 | no panel |
| 5 | 51" H panel |
| 3 | 37" H panel |



The prefix to the four digits in the product number represent the following: 'CP'-panel connector, 'L'-2-way connection, 'T'-3 way connection, 'X'-4-way connection, 'V'-2-way 120°connection and 'Y'-3-way 120°connection. The four digits represent the different heights of panels to be connected. Heights are represented by the first digit.

| | |
|-------------|----|
| 64" H panel | -6 |
| 51" H panel | -5 |
| 37" H panel | -3 |

To specify the correct panel junction, start with the highest panel and move clockwise. For example: To specify a 3-way connection comprised of 51" H and 37" H panels, start with the highest panel, 51" - 5. Proceed clockwise, 0 for no panels, 5 for 51" and 3 for 37". The code is 5053.

FINISHES

Vertical trims are available in any of the colors shown in our current Paint Card and Fans plus textured paint finishes.

NOTE: Tapered vertical trim is available in any of the colors shown in our current Paint Card and Fans plus textured paint finishes.

If you don't find your configuration listed as standard product, send your request to specials@inscapesolutions.com with a copy of the connection layout.

Architecture

Frames and Screens
3 1/2" Thick Standard Frames

System

PRODUCT CODE KEY EXAMPLE

INOF348-3F

INOF Inscape System Frame

3 37" H



48 48" W

3F 3 1/2" thick frame w/
electrical cover plate

- Includes electrical cover kit at the beltline location painted in Eco Black
- 2" deep glide cap color of black or gray (gray default)
- 1 wire manager hanger included with frame
- Compatible with electrical launched December 2010 only
- A Beltline power track is to be specified in the beltline location
- Rectangular glides available for an upcharge of \$15 per frame

NOTES

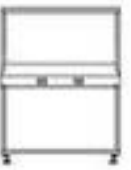
- **18" – 24" W frames do not come with electrical cutouts**
- **30" W frames come with only 1 cutout**
- **Top caps are to be ordered separately**

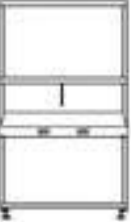
| | Part number | H | W | Thickness | List price |
|---|----------------------|-----|-----|-----------|------------|
|  | 37" H Standard Frame | | | | |
| | INOF318-3F | 37" | 18" | 3 1/2" | \$317 |
| | INOF324-3F | 37" | 24" | 3 1/2" | \$322 |
| | INOF330-3F | 37" | 30" | 3 1/2" | \$339 |
| | INOF336-3F | 37" | 36" | 3 1/2" | \$345 |
| | INOF342-3F | 37" | 42" | 3 1/2" | \$351 |
| | INOF348-3F | 37" | 48" | 3 1/2" | \$357 |
| | INOF354-3F | 37" | 54" | 3 1/2" | \$360 |
| | INOF360-3F | 37" | 60" | 3 1/2" | \$373 |
|  | 44" H Standard Frame | | | | |
| | INOF418-3F | 44" | 18" | 3 1/2" | \$347 |
| | INOF424-3F | 44" | 24" | 3 1/2" | \$348 |
| | INOF430-3F | 44" | 30" | 3 1/2" | \$353 |
| | INOF436-3F | 44" | 36" | 3 1/2" | \$360 |
| | INOF442-3F | 44" | 42" | 3 1/2" | \$368 |
| | INOF448-3F | 44" | 48" | 3 1/2" | \$375 |
| | INOF454-3F | 44" | 54" | 3 1/2" | \$377 |
| | INOF460-3F | 44" | 60" | 3 1/2" | \$380 |
|  | 51" H Standard Frame | | | | |
| | INOF518-3F | 51" | 18" | 3 1/2" | \$362 |
| | INOF524-3F | 51" | 24" | 3 1/2" | \$368 |
| | INOF530-3F | 51" | 30" | 3 1/2" | \$377 |
| | INOF536-3F | 51" | 36" | 3 1/2" | \$389 |
| | INOF542-3F | 51" | 42" | 3 1/2" | \$398 |
| | INOF548-3F | 51" | 48" | 3 1/2" | \$415 |
| | INOF554-3F | 51" | 54" | 3 1/2" | \$420 |
| | INOF560-3F | 51" | 60" | 3 1/2" | \$434 |
|  | 57" H Standard Frame | | | | |
| | INOF5718-3F | 57" | 18" | 3 1/2" | \$387 |
| | INOF5724-3F | 57" | 24" | 3 1/2" | \$397 |
| | INOF5730-3F | 57" | 30" | 3 1/2" | \$404 |
| | INOF5736-3F | 57" | 36" | 3 1/2" | \$424 |
| | INOF5742-3F | 57" | 42" | 3 1/2" | \$435 |
| | INOF5748-3F | 57" | 48" | 3 1/2" | \$452 |
| | INOF5754-3F | 57" | 54" | 3 1/2" | \$456 |
| | INOF5760-3F | 57" | 60" | 3 1/2" | \$471 |

Architecture

Frames and Screens
3 1/2" Thick Standard Frames

System

PRODUCT CODE KEY EXAMPLE

INOF348-3F

INOF Inscape System Frame

3 37" H

48 48" W

3F 3 1/2" thick frame w/
electrical cover plate

- Includes electrical cover kit at the beltline location painted in Eco Black
- 2" deep glide cap color of black or gray (gray default)
- 1 wire manager hanger included with frame
- Compatible with electrical launched December 2010 only
- A Beltline power track is to be specified in the beltline location
- Rectangular glides available for an upcharge of \$15 per frame

NOTES

- 18" – 24" W frames do not come with electrical cutouts
- 30" W frames come with only 1 cutout
- Top caps are to be ordered separately

| | Part number | H | W | Thickness | List price | |
|--|----------------------|-------------------|-----|-----------|------------|-------|
|  | 64" H Standard Frame | INOF618-3F | 64" | 18" | 3 1/2" | \$403 |
| | | INOF624-3F | 64" | 24" | 3 1/2" | \$416 |
| | | INOF630-3F | 64" | 30" | 3 1/2" | \$428 |
| | | INOF636-3F | 64" | 36" | 3 1/2" | \$445 |
| | | INOF642-3F | 64" | 42" | 3 1/2" | \$463 |
| | | INOF648-3F | 64" | 48" | 3 1/2" | \$479 |
| | | INOF654-3F | 64" | 54" | 3 1/2" | \$484 |
| | | INOF660-3F | 64" | 60" | 3 1/2" | \$502 |

Architecture

Frames and Screens
3 1/2" Thick Basic Frames

System

PRODUCT CODE KEY EXAMPLE

INOF348-3NPF

INOF Inscape System Frame

3 37" H



48 48" W

3NPF 3 1/2" thick frame non powered

- 2" deep glide cap color of black or gray (gray default)
- 24" H frame is equipped with hardware to attach to storage case
- 1 wire manager hanger included with frame
- Compatible with electrical launched after December 2010 only
- If powering a Basic frame, an Upper Deck power track kit is to be specified for all locations in the 3.5" thick frame
- Rectangular glides available for an upcharge of \$15 per frame

NOTES

- Top caps are to be ordered separately

| | | Part number | H | W | Thickness | List price |
|---|-------------------|----------------------|-----|-----|-----------|------------|
|  | 24" H Basic Frame | INOF2418-3NPF | 24" | 18" | 3 1/2" | \$180 |
| | | INOF2424-3NPF | 24" | 24" | 3 1/2" | \$184 |
| | | INOF2430-3NPF | 24" | 30" | 3 1/2" | \$195 |
| | | INOF2436-3NPF | 24" | 36" | 3 1/2" | \$199 |
| | | INOF2442-3NPF | 24" | 42" | 3 1/2" | \$202 |
| | | INOF2448-3NPF | 24" | 48" | 3 1/2" | \$205 |
| | | INOF2454-3NPF | 24" | 54" | 3 1/2" | \$208 |
| | | INOF2460-3NPF | 24" | 60" | 3 1/2" | \$211 |
|  | 29" H Basic Frame | INOF218-3NPF | 29" | 18" | 3 1/2" | \$227 |
| | | INOF224-3NPF | 29" | 24" | 3 1/2" | \$229 |
| | | INOF230-3NPF | 29" | 30" | 3 1/2" | \$243 |
| | | INOF236-3NPF | 29" | 36" | 3 1/2" | \$247 |
| | | INOF242-3NPF | 29" | 42" | 3 1/2" | \$250 |
| | | INOF248-3NPF | 29" | 48" | 3 1/2" | \$252 |
| | | INOF254-3NPF | 29" | 54" | 3 1/2" | \$254 |
| | | INOF260-3NPF | 29" | 60" | 3 1/2" | \$256 |
|  | 37" H Basic Frame | INOF318-3NPF | 37" | 18" | 3 1/2" | \$238 |
| | | INOF324-3NPF | 37" | 24" | 3 1/2" | \$243 |
| | | INOF330-3NPF | 37" | 30" | 3 1/2" | \$253 |
| | | INOF336-3NPF | 37" | 36" | 3 1/2" | \$256 |
| | | INOF342-3NPF | 37" | 42" | 3 1/2" | \$262 |
| | | INOF348-3NPF | 37" | 48" | 3 1/2" | \$263 |
| | | INOF354-3NPF | 37" | 54" | 3 1/2" | \$265 |
| | | INOF360-3NPF | 37" | 60" | 3 1/2" | \$270 |

Architecture

Frames and Screens
3 1/2" Thick Basic Frames

System

PRODUCT CODE KEY EXAMPLE

INOF348-3NPF

INOF Inscape System Frame

3 37" H





48 48" W

3NPF 3 1/2" thick frame non powered

- 2" deep glide cap color of black or gray (gray default)
- 24" H frame is equipped with hardware to attach to storage case
- 1 wire manager hanger included with frame
- Compatible with electrical launched after December 2010 only
- If powering a Basic frame, an Upper Deck power track kit is to be specified for all locations in the 3.5" thick frame
- Rectangular glides available for an upcharge of \$15 per frame

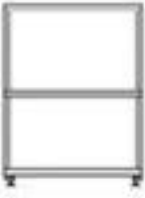
NOTES

- Top caps are to be ordered separately

| | | Part number | H | W | Thickness | List price |
|---|-------------------|----------------------|-----|-----|-----------|------------|
|  | 44" H Basic Frame | INOF418-3NPF | 44" | 18" | 3 1/2" | \$266 |
| | | INOF424-3NPF | 44" | 24" | 3 1/2" | \$270 |
| | | INOF430-3NPF | 44" | 30" | 3 1/2" | \$273 |
| | | INOF436-3NPF | 44" | 36" | 3 1/2" | \$277 |
| | | INOF442-3NPF | 44" | 42" | 3 1/2" | \$281 |
| | | INOF448-3NPF | 44" | 48" | 3 1/2" | \$286 |
| | | INOF454-3NPF | 44" | 54" | 3 1/2" | \$290 |
| | | INOF460-3NPF | 44" | 60" | 3 1/2" | \$294 |
|  | 51" H Basic Frame | INOF518-3NPF | 51" | 18" | 3 1/2" | \$283 |
| | | INOF524-3NPF | 51" | 24" | 3 1/2" | \$287 |
| | | INOF530-3NPF | 51" | 30" | 3 1/2" | \$292 |
| | | INOF536-3NPF | 51" | 36" | 3 1/2" | \$299 |
| | | INOF542-3NPF | 51" | 42" | 3 1/2" | \$309 |
| | | INOF548-3NPF | 51" | 48" | 3 1/2" | \$320 |
| | | INOF554-3NPF | 51" | 54" | 3 1/2" | \$324 |
| | | INOF560-3NPF | 51" | 60" | 3 1/2" | \$332 |
|  | 57" H Basic Frame | INOF5718-3NPF | 57" | 18" | 3 1/2" | \$310 |
| | | INOF5724-3NPF | 57" | 24" | 3 1/2" | \$318 |
| | | INOF5730-3NPF | 57" | 30" | 3 1/2" | \$321 |
| | | INOF5736-3NPF | 57" | 36" | 3 1/2" | \$333 |
| | | INOF5742-3NPF | 57" | 42" | 3 1/2" | \$345 |
| | | INOF5748-3NPF | 57" | 48" | 3 1/2" | \$355 |
| | | INOF5754-3NPF | 57" | 54" | 3 1/2" | \$357 |
| | | INOF5760-3NPF | 57" | 60" | 3 1/2" | \$370 |
|  | 64" H Basic Frame | INOF618-3NPF | 64" | 18" | 3 1/2" | \$328 |
| | | INOF624-3NPF | 64" | 24" | 3 1/2" | \$339 |
| | | INOF630-3NPF | 64" | 30" | 3 1/2" | \$340 |
| | | INOF636-3NPF | 64" | 36" | 3 1/2" | \$357 |
| | | INOF642-3NPF | 64" | 42" | 3 1/2" | \$374 |
| | | INOF648-3NPF | 64" | 48" | 3 1/2" | \$383 |
| | | INOF654-3NPF | 64" | 54" | 3 1/2" | \$385 |
| | | INOF660-3NPF | 64" | 60" | 3 1/2" | \$400 |

Architecture

Frames and Screens
3 1/2" Thick Stack-on Frames

System

PRODUCT CODE KEY EXAMPLE

INSF048-3F

INSF Inscape System
Stack-on Frame

0 6.75" H





48 48" W

3F 3 1/2" thick frame

- Fully welded stack on kits easily installed and removed to adjust panel heights
- Load bearing – only one overhead unit on frame higher than 64" H
- Stack on frames may span multiple frames
*See *Application Guide for spanning guidelines*

NOTES

- Be sure to specify correct thickness of stack frame based on the frame it is being installed on
- May be stacked up to 91" H

| | | Part number | H | W | Thickness | List price |
|---|--------------------------|--------------------|--------|-----|-----------|------------|
|  | 6.75" H Single Stack-On | INSF018-3F | 6.75" | 18" | 3 1/2" | \$157 |
| | | INSF024-3F | 6.75" | 24" | 3 1/2" | \$161 |
| | | INSF030-3F | 6.75" | 30" | 3 1/2" | \$162 |
| | | INSF036-3F | 6.75" | 36" | 3 1/2" | \$166 |
| | | INSF042-3F | 6.75" | 42" | 3 1/2" | \$169 |
| | | INSF048-3F | 6.75" | 48" | 3 1/2" | \$174 |
| | | INSF054-3F | 6.75" | 54" | 3 1/2" | \$175 |
| | | INSF060-3F | 6.75" | 60" | 3 1/2" | \$179 |
|  | 13.5" H Single Stack-On | INSF118-3F | 13.5" | 18" | 3 1/2" | \$164 |
| | | INSF124-3F | 13.5" | 24" | 3 1/2" | \$166 |
| | | INSF130-3F | 13.5" | 30" | 3 1/2" | \$167 |
| | | INSF136-3F | 13.5" | 36" | 3 1/2" | \$170 |
| | | INSF142-3F | 13.5" | 42" | 3 1/2" | \$174 |
| | | INSF148-3F | 13.5" | 48" | 3 1/2" | \$180 |
| | | INSF154-3F | 13.5" | 54" | 3 1/2" | \$183 |
| | | INSF160-3F | 13.5" | 60" | 3 1/2" | \$184 |
|  | 20.25" H Single Stack-On | INSF2018-3F | 20.25" | 18" | 3 1/2" | \$170 |
| | | INSF2024-3F | 20.25" | 24" | 3 1/2" | \$175 |
| | | INSF2030-3F | 20.25" | 30" | 3 1/2" | \$178 |
| | | INSF2036-3F | 20.25" | 36" | 3 1/2" | \$183 |
| | | INSF2042-3F | 20.25" | 42" | 3 1/2" | \$187 |
| | | INSF2048-3F | 20.25" | 48" | 3 1/2" | \$191 |
| | | INSF2054-3F | 20.25" | 54" | 3 1/2" | \$192 |
| | | INSF2060-3F | 20.25" | 60" | 3 1/2" | \$195 |
|  | 27" H Single Stack-On | INSF218-3F | 27" | 18" | 3 1/2" | \$185 |
| | | INSF224-3F | 27" | 24" | 3 1/2" | \$194 |
| | | INSF230-3F | 27" | 30" | 3 1/2" | \$195 |
| | | INSF236-3F | 27" | 36" | 3 1/2" | \$199 |
| | | INSF242-3F | 27" | 42" | 3 1/2" | \$201 |
| | | INSF248-3F | 27" | 48" | 3 1/2" | \$207 |
| | | INSF254-3F | 27" | 54" | 3 1/2" | \$208 |
| | | INSF260-3F | 27" | 60" | 3 1/2" | \$209 |

Architecture

Frames and Screens

3 1/2" Thick Double Glazed Stack-on Frames

System

PRODUCT CODE KEY EXAMPLE

INSTGL24-3F

INST Inscape System
Stack-on Frame

GL double glaze

24 24" W

3F 3 1/2" thick frame

- Clear and frosted acrylic options available.
- Must only be installed in the top location
- Is not load bearing.
- Stack on Double Glaze may span two frames.
**See Application Guide for spanning guidelines*
- 24" to 48" W kits consist of welded frames
- 54" to 96" W kits are kitted and must be assembled onsite

NOTES

Be sure to specify correct thickness of stack frame based on the frame it is being installed on.

In order to get a total cost on products when upcharges are present take the list price of the product number and add the upcharge cost shown to the list price.

For example:

Product INSTGL24-3F in Frosted Acrylic would be \$474 +\$84

| | | Part number | H | W | Thickness | Clear acrylic | Frosted acrylic | Accent paint |
|---|---------------------------------------|--------------------|-------|-----|-----------|---------------|-----------------|--------------|
|  | 13.5" H Double Glaze Stack-On Acrylic | INSTGL24-3F | 13.5" | 24" | 3 1/2" | \$474 | +\$84 | +\$50 |
| | | INSTGL30-3F | 13.5" | 30" | 3 1/2" | \$532 | +\$92 | +\$56 |
| | | INSTGL36-3F | 13.5" | 36" | 3 1/2" | \$607 | +\$103 | +\$63 |
| | | INSTGL42-3F | 13.5" | 42" | 3 1/2" | \$658 | +\$114 | +\$67 |
| | | INSTGL48-3F | 13.5" | 48" | 3 1/2" | \$726 | +\$126 | +\$74 |
| | | INSTGL54-3F | 13.5" | 54" | 3 1/2" | \$795 | +\$124 | +\$84 |
| | | INSTGL60-3F | 13.5" | 60" | 3 1/2" | \$863 | +\$135 | +\$89 |
| | | INSTGL66-3F | 13.5" | 66" | 3 1/2" | \$931 | +\$160 | +\$96 |
| | | INSTGL72-3F | 13.5" | 72" | 3 1/2" | \$958 | +\$164 | +\$99 |
| | | INSTGL78-3F | 13.5" | 78" | 3 1/2" | \$985 | +\$168 | +\$101 |
| | | INSTGL84-3F | 13.5" | 84" | 3 1/2" | \$1015 | +\$171 | +\$103 |
| | | INSTGL90-3F | 13.5" | 90" | 3 1/2" | \$1043 | +\$178 | +\$106 |
| | | INSTGL96-3F | 13.5" | 96" | 3 1/2" | \$1069 | +\$182 | +\$108 |

Architecture

Frames and Screens
2 3/4" Thick Standard Frames

System

PRODUCT CODE KEY EXAMPLE



INOF342-2F

| | |
|-------------|-----------------------------|
| INOF | Inscape System Frame |
| 3 | 37" H |
| 42 | 42" W |
| 2F | 2 3/4" thick standard frame |

- Includes electrical cover kit at the beltline location painted in Eco Black
- 2" deep glide cap color of black or gray (gray default)
- 1 wire manager hanger included with frame
- Compatible with electrical launched after December 2010 only
- A Beltline power track is to be specified in the beltline location
- See Application guide for restrictions with cabling
- Rectangular glides available for an upcharge of \$15 per frame

NOTES

- 18" – 24" W frames do not come with electrical cutouts
- 30" W frames come with 1 electrical cutout
- 27" H tiles cannot be mounted in bottom position on a 2.75" thick standard frame
- Tiles cannot be placed over cover kit (beltline location) on 2.75" frame
- Top caps are to be ordered separately

| | Part number | H | W | Thickness | List price |
|---|----------------------|-----|-----|-----------|------------|
|  | 37" H Standard Frame | | | | |
| | INOF318-2F | 37" | 18" | 2 3/4" | \$317 |
| | INOF324-2F | 37" | 24" | 2 3/4" | \$322 |
| | INOF330-2F | 37" | 30" | 2 3/4" | \$339 |
| | INOF336-2F | 37" | 36" | 2 3/4" | \$345 |
| | INOF342-2F | 37" | 42" | 2 3/4" | \$351 |
| | INOF348-2F | 37" | 48" | 2 3/4" | \$357 |
| | INOF354-2F | 37" | 54" | 2 3/4" | \$360 |
| | INOF360-2F | 37" | 60" | 2 3/4" | \$373 |
|  | 44" H Standard Frame | | | | |
| | INOF418-2F | 44" | 18" | 2 3/4" | \$347 |
| | INOF424-2F | 44" | 24" | 2 3/4" | \$348 |
| | INOF430-2F | 44" | 30" | 2 3/4" | \$353 |
| | INOF436-2F | 44" | 36" | 2 3/4" | \$360 |
| | INOF442-2F | 44" | 42" | 2 3/4" | \$368 |
| | INOF448-2F | 44" | 48" | 2 3/4" | \$375 |
| | INOF454-2F | 44" | 54" | 2 3/4" | \$377 |
| | INOF460-2F | 44" | 60" | 2 3/4" | \$380 |
|  | 51" H Standard Frame | | | | |
| | INOF518-2F | 51" | 18" | 2 3/4" | \$362 |
| | INOF524-2F | 51" | 24" | 2 3/4" | \$368 |
| | INOF530-2F | 51" | 30" | 2 3/4" | \$377 |
| | INOF536-2F | 51" | 36" | 2 3/4" | \$389 |
| | INOF542-2F | 51" | 42" | 2 3/4" | \$398 |
| | INOF548-2F | 51" | 48" | 2 3/4" | \$415 |
| | INOF554-2F | 51" | 54" | 2 3/4" | \$420 |
| | INOF560-2F | 51" | 60" | 2 3/4" | \$434 |

Architecture

Frames and Screens
2 3/4" Thick Standard Frames

System

PRODUCT CODE KEY EXAMPLE



INOF342-2F

| | |
|-------------|-----------------------------|
| INOF | Inscape System Frame |
| 3 | 37" H |
| 42 | 42" W |
| 2F | 2 3/4" thick standard frame |

- Includes electrical cover kit at the beltline location painted in Eco Black
- 2" deep glide cap color of black or gray (gray default)
- 1 wire manager hanger included with frame
- Compatible with electrical launched after December 2010 only
- A Beltline power track is to be specified in the beltline location
- See Application guide for restrictions with cabling
- Rectangular glides available for an upcharge of \$15 per frame

NOTES

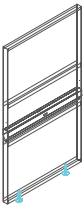
- 18" – 24" W frames do not come with electrical cutouts
- 30" W frames come with 1 electrical cutout
- 27" H tiles cannot be mounted in bottom position on a 2.75" thick standard frame
- Tiles cannot be placed over cover kit (beltline location) on 2.75" frame
- Top caps are to be ordered separately

| | Part number | H | W | Thickness | List price |
|---|----------------------|-----|-----|-----------|------------|
|  | 57" H Standard Frame | | | | |
| | INOF5718-2F | 57" | 18" | 2 3/4" | \$387 |
| | INOF5724-2F | 57" | 24" | 2 3/4" | \$397 |
| | INOF5730-2F | 57" | 30" | 2 3/4" | \$404 |
| | INOF5736-2F | 57" | 36" | 2 3/4" | \$424 |
| | INOF5742-2F | 57" | 42" | 2 3/4" | \$435 |
| | INOF5748-2F | 57" | 48" | 2 3/4" | \$452 |
| | INOF5754-2F | 57" | 54" | 2 3/4" | \$456 |
| | INOF5760-2F | 57" | 60" | 2 3/4" | \$471 |
|  | 64" H Standard Frame | | | | |
| | INOF618-2F | 64" | 18" | 2 3/4" | \$403 |
| | INOF624-2F | 64" | 24" | 2 3/4" | \$416 |
| | INOF630-2F | 64" | 30" | 2 3/4" | \$428 |
| | INOF636-2F | 64" | 36" | 2 3/4" | \$445 |
| | INOF642-2F | 64" | 42" | 2 3/4" | \$463 |
| | INOF648-2F | 64" | 48" | 2 3/4" | \$479 |
| | INOF654-2F | 64" | 54" | 2 3/4" | \$484 |
| | INOF660-2F | 64" | 60" | 2 3/4" | \$502 |

Architecture

Frames and Screens
2 3/4" Thick Basic Frames

System

PRODUCT CODE KEY EXAMPLE

INOF342-2NPF

INOF Inscape System Frame

3 37" H



42 42" W

2NPF 2 3/4" thick frame non powered

- 2" deep glide cap color of black or gray (gray default)
- 24" H frame is equipped with hardware to attach to storage case
- 1 wire manager hanger included with frame
- Compatible with electrical launched after December 2010 only
- If powering a Basic frame, an Upper Deck power track kit is to be specified for all locations in the 2.75" thick frame
- Rectangular glides available for an upcharge of \$15 per frame

NOTES

- 18" – 24" W frames do not come with electrical cutouts
- 30" W frames come with 1 electrical cutout
- Top caps are to be ordered separately

| | | Part number | H | W | Thickness | List price |
|---|-------------------|----------------------|-----|-----|-----------|------------|
|  | 24" H Basic Frame | INOF2418-2NPF | 24" | 18" | 2 3/4" | \$180 |
| | | INOF2424-2NPF | 24" | 24" | 2 3/4" | \$184 |
| | | INOF2430-2NPF | 24" | 30" | 2 3/4" | \$195 |
| | | INOF2436-2NPF | 24" | 36" | 2 3/4" | \$199 |
| | | INOF2442-2NPF | 24" | 42" | 2 3/4" | \$202 |
| | | INOF2448-2NPF | 24" | 48" | 2 3/4" | \$205 |
| | | INOF2454-2NPF | 24" | 54" | 2 3/4" | \$208 |
| | | INOF2460-2NPF | 24" | 60" | 2 3/4" | \$211 |
|  | 29" H Basic Frame | INOF218-2NPF | 29" | 18" | 2 3/4" | \$227 |
| | | INOF224-2NPF | 29" | 24" | 2 3/4" | \$229 |
| | | INOF230-2NPF | 29" | 30" | 2 3/4" | \$243 |
| | | INOF236-2NPF | 29" | 36" | 2 3/4" | \$247 |
| | | INOF242-2NPF | 29" | 42" | 2 3/4" | \$250 |
| | | INOF248-2NPF | 29" | 48" | 2 3/4" | \$252 |
| | | INOF254-2NPF | 29" | 54" | 2 3/4" | \$254 |
| | | INOF260-2NPF | 29" | 60" | 2 3/4" | \$256 |
|  | 37" H Basic Frame | INOF318-2NPF | 37" | 18" | 2 3/4" | \$238 |
| | | INOF324-2NPF | 37" | 24" | 2 3/4" | \$243 |
| | | INOF330-2NPF | 37" | 30" | 2 3/4" | \$253 |
| | | INOF336-2NPF | 37" | 36" | 2 3/4" | \$256 |
| | | INOF342-2NPF | 37" | 42" | 2 3/4" | \$262 |
| | | INOF348-2NPF | 37" | 48" | 2 3/4" | \$263 |
| | | INOF354-2NPF | 37" | 54" | 2 3/4" | \$265 |
| | | INOF360-2NPF | 37" | 60" | 2 3/4" | \$270 |

Architecture

Frames and Screens
2 3/4" Thick Basic Frames

System

PRODUCT CODE KEY EXAMPLE

INOF342-2NPF

INOF Inscape System Frame

3 37" H





42 42" W

2NPF 2 3/4" thick frame non powered

- 2" deep glide cap color of black or gray (gray default)
- 24" H frame is equipped with hardware to attach to storage case
- 1 wire manager hanger included with frame
- Compatible with electrical launched after December 2010 only
- If powering a Basic frame, an Upper Deck power track kit is to be specified for all locations in the 2.75" thick frame
- Rectangular glides available for an upcharge of \$15 per frame

NOTES

- 18" – 24" W frames do not come with electrical cutouts
- 30" W frames come with 1 electrical cutout
- Top caps are to be ordered separately

| | | Part number | H | W | Thickness | List price |
|---|-------------------|----------------------|-----|-----|-----------|------------|
|  | 44" H Basic Frame | INOF418-2NPF | 44" | 18" | 2 3/4" | \$266 |
| | | INOF424-2NPF | 44" | 24" | 2 3/4" | \$270 |
| | | INOF430-2NPF | 44" | 30" | 2 3/4" | \$273 |
| | | INOF436-2NPF | 44" | 36" | 2 3/4" | \$277 |
| | | INOF442-2NPF | 44" | 42" | 2 3/4" | \$281 |
| | | INOF448-2NPF | 44" | 48" | 2 3/4" | \$286 |
| | | INOF454-2NPF | 44" | 54" | 2 3/4" | \$290 |
| | | INOF460-2NPF | 44" | 60" | 2 3/4" | \$294 |
|  | 51" H Basic Frame | INOF518-2NPF | 51" | 18" | 2 3/4" | \$283 |
| | | INOF524-2NPF | 51" | 24" | 2 3/4" | \$287 |
| | | INOF530-2NPF | 51" | 30" | 2 3/4" | \$292 |
| | | INOF536-2NPF | 51" | 36" | 2 3/4" | \$299 |
| | | INOF542-2NPF | 51" | 42" | 2 3/4" | \$309 |
| | | INOF548-2NPF | 51" | 48" | 2 3/4" | \$320 |
| | | INOF554-2NPF | 51" | 54" | 2 3/4" | \$324 |
| | | INOF560-2NPF | 51" | 60" | 2 3/4" | \$332 |
|  | 57" H Basic Frame | INOF5718-2NPF | 57" | 18" | 2 3/4" | \$310 |
| | | INOF5724-2NPF | 57" | 24" | 2 3/4" | \$318 |
| | | INOF5730-2NPF | 57" | 30" | 2 3/4" | \$321 |
| | | INOF5736-2NPF | 57" | 36" | 2 3/4" | \$333 |
| | | INOF5742-2NPF | 57" | 42" | 2 3/4" | \$345 |
| | | INOF5748-2NPF | 57" | 48" | 2 3/4" | \$355 |
| | | INOF5754-2NPF | 57" | 54" | 2 3/4" | \$357 |
| | | INOF5760-2NPF | 57" | 60" | 2 3/4" | \$370 |
|  | 64" H Basic Frame | INOF618-2NPF | 64" | 18" | 2 3/4" | \$328 |
| | | INOF624-2NPF | 64" | 24" | 2 3/4" | \$339 |
| | | INOF630-2NPF | 64" | 30" | 2 3/4" | \$340 |
| | | INOF636-2NPF | 64" | 36" | 2 3/4" | \$357 |
| | | INOF642-2NPF | 64" | 42" | 2 3/4" | \$374 |
| | | INOF648-2NPF | 64" | 48" | 2 3/4" | \$383 |
| | | INOF654-2NPF | 64" | 54" | 2 3/4" | \$385 |
| | | INOF660-2NPF | 64" | 60" | 2 3/4" | \$400 |

Architecture

Frames and Screens
2 3/4" Thick Stack-on Frames

System

PRODUCT CODE KEY EXAMPLE





INSF048-2F

| | |
|-------------|-------------------------------|
| INSF | Inscape System Stack-on Frame |
| 0 | 6.75" H |
| 48 | 48" W |
| 2F | 2 3/4" thick fram |

- Fully welded stack on kits easily installed and removed to adjust panel height.
- Load bearing – only one overhead unit on frame higher than 64" H only.
- Stack-on frames may span multiple frames.
*See Application Guide for spanning guidelines.

NOTES

- Be sure to specify correct thickness of stack frame based on the frame it is being installed on
- May be stacked up to 91" H

| | | Part number | H | W | Thickness | List price |
|---|--------------------------|--------------------|--------|-----|-----------|------------|
|  | 6.75" H Single Stack-On | INSF018-2F | 6.75" | 18" | 2 3/4" | \$157 |
| | | INSF024-2F | 6.75" | 24" | 2 3/4" | \$161 |
| | | INSF030-2F | 6.75" | 30" | 2 3/4" | \$162 |
| | | INSF036-2F | 6.75" | 36" | 2 3/4" | \$166 |
| | | INSF042-2F | 6.75" | 42" | 2 3/4" | \$169 |
| | | INSF048-2F | 6.75" | 48" | 2 3/4" | \$174 |
| | | INSF054-2F | 6.75" | 54" | 2 3/4" | \$175 |
| | | INSF060-2F | 6.75" | 60" | 2 3/4" | \$179 |
|  | 13.5" H Single Stack-On | INSF118-2F | 13.5" | 18" | 2 3/4" | \$164 |
| | | INSF124-2F | 13.5" | 24" | 2 3/4" | \$166 |
| | | INSF130-2F | 13.5" | 30" | 2 3/4" | \$167 |
| | | INSF136-2F | 13.5" | 36" | 2 3/4" | \$170 |
| | | INSF142-2F | 13.5" | 42" | 2 3/4" | \$174 |
| | | INSF148-2F | 13.5" | 48" | 2 3/4" | \$180 |
| | | INSF154-2F | 13.5" | 54" | 2 3/4" | \$183 |
| | | INSF160-2F | 13.5" | 60" | 2 3/4" | \$184 |
|  | 20.25" H Single Stack-On | INSF2018-2F | 20.25" | 18" | 2 3/4" | \$170 |
| | | INSF2024-2F | 20.25" | 24" | 2 3/4" | \$175 |
| | | INSF2030-2F | 20.25" | 30" | 2 3/4" | \$178 |
| | | INSF2036-2F | 20.25" | 36" | 2 3/4" | \$183 |
| | | INSF2042-2F | 20.25" | 42" | 2 3/4" | \$187 |
| | | INSF2048-2F | 20.25" | 48" | 2 3/4" | \$191 |
| | | INSF2054-2F | 20.25" | 54" | 2 3/4" | \$192 |
| | | INSF2060-2F | 20.25" | 60" | 2 3/4" | \$195 |
|  | 27" H Single Stack-On | INSF218-2F | 27" | 18" | 2 3/4" | \$185 |
| | | INSF224-2F | 27" | 24" | 2 3/4" | \$194 |
| | | INSF230-2F | 27" | 30" | 2 3/4" | \$195 |
| | | INSF236-2F | 27" | 36" | 2 3/4" | \$199 |
| | | INSF242-2F | 27" | 42" | 2 3/4" | \$201 |
| | | INSF248-2F | 27" | 48" | 2 3/4" | \$207 |
| | | INSF254-2F | 27" | 54" | 2 3/4" | \$208 |
| | | INSF260-2F | 27" | 60" | 2 3/4" | \$209 |

Architecture

Frames and Screens

2 3/4" Thick Double Glazed Stack-on Frames

System

PRODUCT CODE KEY EXAMPLE

INSTGL24-2F

| | |
|-------------|-------------------------------|
| INST | Inscape System Stack-on Frame |
| GL | double glaze |
| 24 | 24" W |
| 2F | 2 3/4" thick frame |

- Clear and frosted acrylic options available
- Must only be installed in the top location
- Is not load bearing
- Stack on Double Glaze may span two frames.
*See *Application Guide for spanning guidelines*
- 24" to 48" W kits consist of welded frames
- 54" to 96" W kits are kitted and must be assembled onsite

NOTES

Be sure to specify correct thickness of stack frame based on the frame it is being installed on.

In order to get a total cost on products when upcharges are present take the list price of the product number and add the upcharge cost shown to the list price.

For example:

Product INSTGL24-2F in Frosted Acrylic would be \$462 +\$84

| | | Part number | H | W | Thickness | Clear acrylic | Frosted acrylic | Accent paint |
|---|---------------------------------------|--------------------|-------|-----|-----------|---------------|-----------------|--------------|
|  | 13.5" H Double Glaze Stack-On Acrylic | INSTGL24-2F | 13.5" | 24" | 2 3/4" | \$462 | +\$84 | +\$49 |
| | | INSTGL30-2F | 13.5" | 30" | 2 3/4" | \$521 | +\$92 | +\$54 |
| | | INSTGL36-2F | 13.5" | 36" | 2 3/4" | \$596 | +\$103 | +\$61 |
| | | INSTGL42-2F | 13.5" | 42" | 2 3/4" | \$645 | +\$114 | +\$66 |
| | | INSTGL48-2F | 13.5" | 48" | 2 3/4" | \$714 | +\$126 | +\$73 |
| | | INSTGL54-2F | 13.5" | 54" | 2 3/4" | \$783 | +\$124 | +\$83 |
| | | INSTGL60-2F | 13.5" | 60" | 2 3/4" | \$862 | +\$135 | +\$89 |
| | | INSTGL66-2F | 13.5" | 66" | 2 3/4" | \$916 | +\$160 | +\$94 |
| | | INSTGL72-2F | 13.5" | 72" | 2 3/4" | \$944 | +\$164 | +\$97 |
| | | INSTGL78-2F | 13.5" | 78" | 2 3/4" | \$974 | +\$168 | +\$100 |
| | | INSTGL84-2F | 13.5" | 84" | 2 3/4" | \$999 | +\$171 | +\$102 |
| | | INSTGL90-2F | 13.5" | 90" | 2 3/4" | \$1030 | +\$178 | +\$105 |
| | | INSTGL96-2F | 13.5" | 96" | 2 3/4" | \$1058 | +\$182 | +\$107 |

Architecture

Frames and Screens
1 1/2" Thick Segmented Screens

System

PRODUCT CODE KEY EXAMPLE

SS378

| | |
|-----------|------------------|
| SS | Segmented Screen |
| 37 | 37" H |
| 18 | 18" W |





- Segmented screens may only be attached to the 3 1/2" thick tapered trim frames or 1 1/2" thick screens (brackets specified separately)
- These screens are not freestanding
- Screens include 2" dia glide with 1 1/2" height adjustability – optional gray (default) or black
- Segmented screens come fully trimmed
- All segments are optioned as one fabric pattern only
- Segments are tackable
- Fabric is applied in a railroad orientation
- Available with round glides only

NOTES

The following fabrics are not available on segmented screens; U5005 Sprite Snow

In order to get a total cost on products when upcharges are present take the list price of the product number and add the upcharge cost shown to the list price.

For example:
Product SS3718 in Grade 5 Fabric would be \$512 +\$91

| | Part number | H | W | Wt (lbs) | Grade 1/ COM/ Base price | Grade 2 | Grade 3 | Grade 4 | Grade 5 | Grade 6 | Grade 7 | Grade 8 | Accent paint |
|---|---------------|-----|-----|----------|--------------------------------|---------|---------|---------|---------|---------|---------|---------|--------------|
|  37" H Segmented Screen | SS3718 | 37" | 18" | 9 | \$512 | +\$31 | +\$44 | — | +\$91 | +\$194 | +\$295 | — | +\$53 |
| | SS3724 | 37" | 24" | 10 | \$538 | +\$32 | +\$50 | — | +\$97 | +\$206 | +\$314 | — | +\$57 |
| | SS3730 | 37" | 30" | 12 | \$583 | +\$39 | +\$60 | — | +\$118 | +\$237 | +\$356 | — | +\$60 |
| | SS3736 | 37" | 36" | 14 | \$630 | +\$50 | +\$77 | — | +\$139 | +\$272 | +\$402 | — | +\$64 |
| | SS3742 | 37" | 42" | 15 | \$675 | +\$59 | +\$92 | — | +\$162 | +\$303 | +\$449 | — | +\$69 |
| | SS3748 | 37" | 48" | 17 | \$701 | +\$59 | +\$92 | — | +\$164 | +\$318 | +\$458 | — | +\$72 |
| | SS3754 | 37" | 54" | 19 | \$729 | +\$59 | +\$92 | — | +\$164 | +\$332 | +\$458 | — | +\$74 |
| | SS3760 | 37" | 60" | 21 | \$754 | +\$59 | +\$91 | — | +\$167 | +\$346 | +\$484 | — | +\$77 |
|  44" H Segmented Screen | SS4418 | 44" | 18" | 11 | \$540 | +\$34 | +\$51 | — | +\$102 | +\$213 | +\$323 | — | +\$57 |
| | SS4424 | 44" | 24" | 12 | \$570 | +\$36 | +\$57 | — | +\$106 | +\$223 | +\$341 | — | +\$59 |
| | SS4430 | 44" | 30" | 14 | \$621 | +\$50 | +\$74 | — | +\$134 | +\$265 | +\$395 | — | +\$64 |
| | SS4436 | 44" | 36" | 15 | \$671 | +\$60 | +\$92 | — | +\$164 | +\$306 | +\$449 | — | +\$69 |
| | SS4442 | 44" | 42" | 17 | \$725 | +\$72 | +\$108 | — | +\$187 | +\$340 | +\$501 | — | +\$74 |
| | SS4448 | 44" | 48" | 19 | \$753 | +\$71 | +\$108 | — | +\$188 | +\$349 | +\$510 | — | +\$77 |
| | SS4454 | 44" | 54" | 21 | \$783 | +\$72 | +\$112 | — | +\$194 | +\$360 | +\$526 | — | +\$83 |
| | SS4460 | 44" | 60" | 23 | \$812 | +\$72 | +\$111 | — | +\$192 | +\$368 | +\$535 | — | +\$85 |
|  51" H Segmented Screen | SS5118 | 51" | 18" | 12 | \$602 | +\$35 | +\$60 | — | +\$124 | +\$248 | +\$371 | — | +\$62 |
| | SS5124 | 51" | 24" | 13 | \$627 | +\$46 | +\$63 | — | +\$127 | +\$262 | +\$382 | — | +\$64 |
| | SS5130 | 51" | 30" | 15 | \$687 | +\$57 | +\$87 | — | +\$159 | +\$303 | +\$445 | — | +\$70 |
| | SS5136 | 51" | 36" | 18 | \$749 | +\$71 | +\$106 | — | +\$185 | +\$346 | +\$506 | — | +\$77 |
| | SS5142 | 51" | 42" | 20 | \$810 | +\$87 | +\$129 | — | +\$216 | +\$362 | +\$569 | — | +\$85 |
| | SS5148 | 51" | 48" | 22 | \$844 | +\$87 | +\$129 | — | +\$216 | +\$383 | +\$569 | — | +\$88 |
| | SS5154 | 51" | 54" | 24 | \$877 | +\$87 | +\$129 | — | +\$216 | +\$400 | +\$569 | — | +\$91 |
| | SS5160 | 51" | 60" | 26 | \$912 | +\$88 | +\$131 | — | +\$223 | +\$427 | +\$616 | — | +\$94 |
|  64" H Segmented Screen | SS6418 | 64" | 18" | 12 | \$708 | +\$54 | +\$79 | — | +\$148 | +\$295 | +\$441 | — | +\$72 |
| | SS6424 | 64" | 24" | 16 | \$719 | +\$56 | +\$87 | — | +\$159 | +\$308 | +\$456 | — | +\$73 |
| | SS6430 | 64" | 30" | 19 | \$793 | +\$76 | +\$114 | — | +\$198 | +\$367 | +\$535 | — | +\$83 |
| | SS6436 | 64" | 36" | 21 | \$869 | +\$94 | +\$140 | — | +\$238 | +\$427 | +\$615 | — | +\$90 |
| | SS6442 | 64" | 42" | 23 | \$947 | +\$112 | +\$167 | — | +\$276 | +\$485 | +\$694 | — | +\$98 |
| | SS6448 | 64" | 48" | 26 | \$988 | +\$111 | +\$168 | — | +\$279 | +\$503 | +\$714 | — | +\$101 |
| | SS6454 | 64" | 54" | 29 | \$1031 | +\$111 | +\$169 | — | +\$281 | +\$518 | +\$732 | — | +\$105 |
| | SS6460 | 64" | 60" | 32 | \$1073 | +\$112 | +\$168 | — | +\$285 | +\$535 | +\$750 | — | +\$110 |

Architecture

Frames and Screens

1 1/2" Thick Glazed Segmented Screens

System

PRODUCT CODE KEY EXAMPLE

SSG6424

| | |
|-----------|------------------|
| SS | Segmented Screen |
| G | Glazed |
| 64 | 64" H |
| 42 | 42" W |

- Glazed Segmented Screens may only be attached to the 3 1/2" thick tapered trim frames or 1 1/2" thick screens (brackets specified separately)
- These screens are not freestanding
- Screens include 2" dia glide with 1 1/2" height adjustability – optional gray (default) or black
- Segmented screens come fully trimmed
- Clear acrylic is included in the top 13.5" segment
- All other segments are optioned as one fabric pattern
- Fabric segments are tackable
- Fabric is applied in a railroad orientation
- Available with round glides only

NOTES

The following fabrics are not available on segmented screens; U5005 Sprite Snow

In order to get a total cost on products when upcharges are present take the list price of the product number and add the upcharge cost shown to the list price.

For example:

Product SSG6424 in Grade 5 Fabric would be \$799 +\$137

| Part number | H | W | Wt (lbs) | Grade 1/ COM/ Base price | Grade 2 | Grade 3 | Grade 4 | Grade 5 | Grade 6 | Grade 7 | Grade 8 | Accent paint |
|----------------|-----|-----|----------|--------------------------------|---------|---------|---------|---------|---------|---------|---------|--------------|
| SSG6424 | 64" | 24" | 16 | \$799 | +\$44 | +\$64 | — | +\$137 | +\$291 | +\$457 | — | +\$84 |
| SSG6430 | 64" | 30" | 19 | \$887 | +\$57 | +\$88 | — | +\$170 | +\$351 | +\$533 | — | +\$92 |
| SSG6436 | 64" | 36" | 21 | \$974 | +\$72 | +\$111 | — | +\$201 | +\$403 | +\$605 | — | +\$100 |
| SSG6442 | 64" | 42" | 23 | \$1059 | +\$87 | +\$131 | — | +\$235 | +\$457 | +\$679 | — | +\$107 |
| SSG6448 | 64" | 48" | 26 | \$1163 | +\$87 | +\$131 | — | +\$246 | +\$486 | +\$726 | — | +\$119 |
| SSG6454 | 64" | 54" | 29 | \$1264 | +\$88 | +\$131 | — | +\$251 | +\$510 | +\$769 | — | +\$129 |
| SSG6460 | 64" | 60" | 32 | \$1365 | +\$88 | +\$131 | — | +\$251 | +\$529 | +\$769 | — | +\$139 |



64" H with Clear Acrylic

Architecture

Frames and Screens
1 1/2" Thick Monolithic Screens

System

PRODUCT CODE KEY EXAMPLE

MS3718

MS Monolithic Screen

37 37" H

18 18" W





- Monolithic screens may only be attached to the 3 1/2" thick tapered trim frames or 1 1/2" thick screens (brackets specified separately)
- These screens are not freestanding
- Screens include 2" dia glide with 1 1/2" height adjustability – optional gray (default) or black
- Monolithic screens come fully trimmed
- Fabric screens are tackable
- Fabric is applied in a railroad orientation
- Clear and White fluted material is polycarbonate and has naturally occurring variances in the material
- Available with round glides only

NOTES

The following fabrics are not available on monolithic screens; U5005 Sprite Snow

In order to get a total cost on products when upcharges are present take the list price of the product number and add the upcharge cost shown to the list price.

For example:
Product MS3718 in Grade 5 Fabric would be \$429 +\$88

| | Part number | H | W | Wt (lbs) | Grade 1/ COM/ Base price | Grade 2 | Grade 3 | Grade 4 | Grade 5 | Grade 6 | Grade 7 | Grade 8 | Clear fluted polycarbonate | White fluted polycarbonate | Accent paint |
|--|---------------|-----|-----|----------|--------------------------------|---------|---------|---------|---------|---------|---------|---------|-------------------------------|-------------------------------|-----------------|
|  37" H Monolithic Screen | MS3718 | 37" | 18" | 9 | \$429 | +\$31 | +\$46 | — | +\$88 | +\$174 | +\$262 | — | — | — | +\$46 |
| | MS3724 | 37" | 24" | 10 | \$463 | +\$31 | +\$46 | — | +\$88 | +\$185 | +\$274 | — | +\$86 | +\$86 | +\$49 |
| | MS3730 | 37" | 30" | 11 | \$504 | +\$37 | +\$59 | — | +\$105 | +\$211 | +\$316 | — | +\$59 | +\$59 | +\$53 |
| | MS3736 | 37" | 36" | 13 | \$546 | +\$50 | +\$76 | — | +\$129 | +\$242 | +\$356 | — | +\$34 | +\$34 | +\$57 |
| | MS3742 | 37" | 42" | 15 | \$584 | +\$57 | +\$89 | — | +\$152 | +\$277 | +\$402 | — | +\$29 | +\$29 | +\$60 |
| | MS3748 | 37" | 48" | 16 | \$607 | +\$58 | +\$90 | — | +\$153 | +\$282 | +\$412 | — | +\$48 | +\$48 | +\$63 |
| | MS3754 | 37" | 54" | 18 | \$633 | +\$60 | +\$90 | — | +\$156 | +\$291 | +\$426 | — | — | — | +\$65 |
| | MS3760 | 37" | 60" | 19 | \$658 | +\$64 | +\$89 | — | +\$157 | +\$295 | +\$435 | — | — | — | +\$67 |
|  44" H Monolithic Screen | MS4418 | 44" | 18" | 10 | \$459 | +\$36 | +\$53 | — | +\$100 | +\$196 | +\$290 | — | — | — | +\$49 |
| | MS4424 | 44" | 24" | 11 | \$494 | +\$42 | +\$53 | — | +\$111 | +\$207 | +\$303 | — | +\$71 | +\$71 | +\$52 |
| | MS4430 | 44" | 30" | 13 | \$542 | +\$48 | +\$69 | — | +\$127 | +\$240 | +\$353 | — | +\$60 | +\$60 | +\$57 |
| | MS4436 | 44" | 36" | 15 | \$591 | +\$56 | +\$87 | — | +\$146 | +\$274 | +\$400 | — | +\$51 | +\$51 | +\$61 |
| | MS4442 | 44" | 42" | 16 | \$636 | +\$69 | +\$104 | — | +\$174 | +\$314 | +\$453 | — | +\$51 | +\$51 | +\$65 |
| | MS4448 | 44" | 48" | 18 | \$663 | +\$71 | +\$103 | — | +\$175 | +\$319 | +\$463 | — | +\$67 | +\$67 | +\$67 |
| | MS4454 | 44" | 54" | 20 | \$688 | +\$73 | +\$102 | — | +\$178 | +\$327 | +\$475 | — | — | — | +\$71 |
| | MS4460 | 44" | 60" | 22 | \$714 | +\$76 | +\$104 | — | +\$180 | +\$333 | +\$488 | — | — | — | +\$73 |
|  51" H Monolithic Screen | MS5118 | 51" | 18" | 11 | \$488 | +\$42 | +\$59 | — | +\$111 | +\$213 | +\$316 | — | — | — | +\$51 |
| | MS5124 | 51" | 24" | 13 | \$526 | +\$48 | +\$61 | — | +\$114 | +\$223 | +\$332 | — | +\$99 | +\$99 | +\$56 |
| | MS5130 | 51" | 30" | 15 | \$579 | +\$54 | +\$85 | — | +\$142 | +\$266 | +\$389 | — | +\$91 | +\$91 | +\$60 |
| | MS5136 | 51" | 36" | 17 | \$634 | +\$64 | +\$101 | — | +\$171 | +\$310 | +\$449 | — | +\$86 | +\$86 | +\$65 |
| | MS5142 | 51" | 42" | 19 | \$686 | +\$83 | +\$120 | — | +\$200 | +\$353 | +\$505 | — | +\$48 | +\$48 | +\$70 |
| | MS5148 | 51" | 48" | 21 | \$714 | +\$84 | +\$121 | — | +\$205 | +\$361 | +\$517 | — | +\$36 | +\$36 | +\$73 |
| | MS5154 | 51" | 54" | 23 | \$744 | +\$87 | +\$121 | — | +\$207 | +\$368 | +\$530 | — | — | — | +\$76 |
| | MS5160 | 51" | 60" | 25 | \$771 | +\$89 | +\$121 | — | +\$215 | +\$378 | +\$540 | — | — | — | +\$81 |
|  64" H Monolithic Screen | MS6418 | 64" | 18" | 11 | \$515 | +\$51 | +\$71 | — | +\$129 | +\$239 | +\$348 | — | — | — | +\$54 |
| | MS6424 | 64" | 24" | 13 | \$563 | +\$60 | +\$85 | — | +\$148 | +\$272 | +\$394 | — | — | — | +\$59 |
| | MS6430 | 64" | 30" | 15 | \$626 | +\$52 | +\$79 | — | +\$142 | +\$295 | +\$405 | — | — | — | +\$64 |
| | MS6436 | 64" | 36" | 17 | \$753 | +\$34 | +\$154 | — | +\$247 | +\$331 | +\$588 | — | — | — | +\$77 |
| | MS6442 | 64" | 42" | 19 | \$788 | +\$67 | +\$157 | — | +\$249 | +\$375 | +\$602 | — | — | — | +\$83 |
| | MS6448 | 64" | 48" | 21 | \$822 | +\$102 | +\$161 | — | +\$249 | +\$415 | +\$615 | — | — | — | +\$86 |

Architecture

Frames and Screens
1 1/2" Thick Monolithic Screens

System

PRODUCT CODE KEY EXAMPLE

MS7118

| | |
|-----------|-------------------|
| MS | Monolithic Screen |
| 71 | 71" H |
| 18 | 18" W |

- Monolithic screens may only be attached to the 3 1/2" thick tapered trim frames or 1 1/2" thick screens (brackets specified separately)
- These screens are not freestanding
- Screens include 2" dia glide with 1 1/2" height adjustability – optional gray (default) or black
- Monolithic screens come fully trimmed
- Fabric screens are tackable
- Fabric is applied in a railroad orientation
- Clear and White fluted material is polycarbonate and has naturally occurring variances in the material
- Available with round glides only

NOTES

The following fabrics are not available on monolithic screens; U5005 Sprite Snow

In order to get a total cost on products when upcharges are present take the list price of the product number and add the upcharge cost shown to the list price.

For example:
Product MS7118 in Grade 5 Fabric would be \$606 +\$142

| Part number | H | W | Wt (lbs) | Grade 1/ COM/ Base price | Grade 2 | Grade 3 | Grade 4 | Grade 5 | Grade 6 | Grade 7 | Grade 8 | Clear fluted polycarbonate | White fluted polycarbonate | Accent paint |
|---------------|-----|-----|----------|--------------------------------|---------|---------|---------|---------|---------|---------|---------|-------------------------------|-------------------------------|-----------------|
| MS7118 | 71" | 18" | 14 | \$606 | +\$56 | +\$79 | — | +\$142 | +\$272 | +\$399 | — | — | — | +\$62 |



71"h Monolithic Screen

Architecture

Frames and Screens
1 1/2" Thick Accessory Screens

System

PRODUCT CODE KEY EXAMPLE

MAS5124

MAS Accessory Screen

51 51" H

24 24" W

- Screens may only be attached to the 3 1/2" thick tapered trim frames or 1 1/2" thick screens (brackets specified separately)
- These screens are not freestanding
- Screens include 2" dia glide with 1 1/2" height adjustability – optional gray (default) or black
- Accessory screens come fully trimmed
- Horizontal accessories including slanted sorters, paper trays and storage compartments may be hung from accessory screen
- Fabric is applied in a railroad orientation
- Tackable
- Available with round glides only

NOTES

The following fabrics are not available on accessory screens; U5005 Sprite Snow

In order to get a total cost on products when upcharges are present take the list price of the product number and add the upcharge cost shown to the list price.

For example:

Product MAS5124 in Grade 5 Fabric would be \$636 +\$118

| Part number | H | W | Wt (lbs) | Grade 1/ COM Base price | Grade 2 | Grade 3 | Grade 4 | Grade 5 | Grade 6 | Grade 7 | Grade 8 | Accent paint |
|--|-----|-----|----------|-------------------------------|---------|---------|---------|---------|---------|---------|---------|-----------------|
|  MAS5124 | 51" | 24" | 13 | \$636 | +\$37 | +\$59 | — | +\$118 | +\$247 | +\$375 | — | +\$65 |
| MAS5130 | 51" | 30" | 14 | \$698 | +\$51 | +\$77 | — | +\$144 | +\$289 | +\$434 | — | +\$71 |
| MAS5136 | 51" | 36" | 15 | \$762 | +\$61 | +\$98 | — | +\$173 | +\$333 | +\$494 | — | +\$79 |
| MAS5142 | 51" | 42" | 15 | \$823 | +\$77 | +\$114 | — | +\$206 | +\$382 | +\$557 | — | +\$86 |
| MAS5148 | 51" | 48" | 16 | \$862 | +\$85 | +\$116 | — | +\$209 | +\$386 | +\$562 | — | +\$89 |
| MAS5154 | 51" | 54" | 17 | \$901 | +\$89 | +\$118 | — | +\$210 | +\$400 | +\$589 | — | +\$93 |
| MAS5160 | 51" | 60" | 18 | \$938 | +\$92 | +\$119 | — | +\$212 | +\$410 | +\$606 | — | +\$97 |

51" H Accessory Screen

| | | | | | | | | | | | | |
|--|-----|-----|----|-------|--------|--------|---|--------|--------|--------|---|-------|
|  MAS6424 | 64" | 24" | 16 | \$745 | +\$52 | +\$77 | — | +\$145 | +\$300 | +\$453 | — | +\$76 |
| MAS6430 | 64" | 30" | 17 | \$803 | +\$66 | +\$101 | — | +\$182 | +\$350 | +\$518 | — | +\$84 |
| MAS6436 | 64" | 36" | 18 | \$864 | +\$85 | +\$127 | — | +\$215 | +\$401 | +\$587 | — | +\$90 |
| MAS6442 | 64" | 42" | 18 | \$923 | +\$99 | +\$148 | — | +\$251 | +\$453 | +\$653 | — | +\$96 |
| MAS6448 | 64" | 48" | 19 | \$967 | +\$103 | +\$152 | — | +\$256 | +\$466 | +\$675 | — | +\$99 |

64" H Accessory Screen

Architecture

Frames and Screens
1 1/2" Thick Freestanding Screens

System

PRODUCT CODE KEY EXAMPLE

MSF5136

| | |
|------------|-----------------------------------|
| MSF | Freestanding Monolithic Screen |
| 51 | 51" H |
| 36 | 36" W |

- Screens include "L" leg for freestanding support, 3/4" height adjustability
- Accessory screens come fully trimmed
- Horizontal accessories including slanted sorters, paper trays and storage compartments may be hung from accessory screen
- Max weight load of 20lbs per side
- See specifics for whiteboard maintenance and marker requirements
- Accessory screen includes tackable surface below whiteboard
- Fabric is applied in a railroad orientation
- Available with round glides only

NOTES

The following fabrics are not available on accessory screens; U5005 Sprite Snow

In order to get a total cost on products when upcharges are present take the list price of the product number and add the upcharge cost shown to the list price.

For example:
Product MSF5136 in Grade 5 Fabric would be \$1048 +\$221

| Part number | H | W | Wt (lbs) | Grade 1/ COM Base price | Grade 2 | Grade 3 | Grade 4 | Grade 5 | Grade 6 | Grade 7 | Grade 8 | Accent paint |
|-----------------|-----|-----|----------|-------------------------------|---------|---------|---------|---------|---------|---------|---------|-----------------|
| SASF5136 | 51" | 36" | 15 | \$1168 | +\$35 | +\$54 | — | +\$146 | +\$373 | +\$599 | — | +\$120 |
| SASF5142 | 51" | 42" | 17 | \$1215 | +\$37 | +\$57 | — | +\$152 | +\$386 | +\$619 | — | +\$125 |
| SASF5148 | 51" | 48" | 19 | \$1264 | +\$44 | +\$61 | — | +\$146 | +\$394 | +\$630 | — | +\$129 |



51" H Freestanding
Whiteboard
Accessory Screen

| | | | | | | | | | | | | |
|-----------------|-----|-----|----|--------|-------|-------|---|--------|--------|--------|---|--------|
| SASF6436 | 64" | 36" | 18 | \$1253 | +\$47 | +\$53 | — | +\$162 | +\$399 | +\$645 | — | +\$128 |
| SASF6442 | 64" | 42" | 20 | \$1307 | +\$50 | +\$54 | — | +\$157 | +\$408 | +\$658 | — | +\$133 |
| SASF6448 | 64" | 48" | 22 | \$1366 | +\$52 | +\$57 | — | +\$162 | +\$418 | +\$659 | — | +\$139 |



64" H Freestanding
Whiteboard
Accessory Screen

| | | | | | | | | | | | | |
|----------------|-----|-----|----|--------|-------|--------|---|--------|--------|--------|---|--------|
| MSF5136 | 51" | 36" | 23 | \$1048 | +\$83 | +\$120 | — | +\$221 | +\$441 | +\$660 | — | +\$106 |
| MSF5142 | 51" | 42" | 25 | \$1077 | +\$84 | +\$121 | — | +\$225 | +\$450 | +\$674 | — | +\$110 |
| MSF5148 | 51" | 48" | 27 | \$1105 | +\$84 | +\$121 | — | +\$227 | +\$457 | +\$686 | — | +\$112 |



51" H Freestanding
Tackable Screen

| | | | | | | | | | | | | |
|----------------|-----|-----|----|--------|--------|--------|---|--------|--------|--------|---|--------|
| MSF6436 | 64" | 36" | 28 | \$1142 | +\$102 | +\$156 | — | +\$274 | +\$511 | +\$759 | — | +\$118 |
| MSF6442 | 64" | 42" | 31 | \$1174 | +\$102 | +\$156 | — | +\$274 | +\$515 | +\$761 | — | +\$120 |
| MSF6448 | 64" | 48" | 33 | \$1209 | +\$102 | +\$156 | — | +\$274 | +\$521 | +\$766 | — | +\$124 |



64" H Freestanding
Tackable Screen

Architecture

Frames and Screens
1 1/2" Thick Table Mounted Screens

System

PRODUCT CODE KEY EXAMPLE

MST3736

| | |
|------------|----------------------|
| MST | Table Mounted Screen |
| 37 | 37" H |
| 36 | 36" W |

- May be installed on Inscape Worksurfaces
- Adjustable Framed Table Mounted Screens have height adjustment for above worksurface privacy and below the worksurface modesty. It is recommended that this screen be installed with a max of 20" above the surface.
- May not be specified to attach to a 3 1/2" thick frame connector
- Fabric is applied in railed orientation
- Table mounted screen is tackable

NOTES

The following fabrics are not available on accessory screens; U5005 Sprite Snow

In order to get a total cost on products when upcharges are present take the list price of the product number and add the upcharge cost shown to the list price.

For example:

Product MST3736 in Grade 7 Fabric would be \$607 +\$426

| Part number | H | W | Wt (lbs) | Grade 1/ COM Base price | Grade 2 | Grade 3 | Grade 4 | Grade 5 | Grade 6 | Grade 7 | Grade 8 | Accent paint |
|----------------|-----|-----|----------|-------------------------------|---------|---------|---------|---------|---------|---------|---------|-----------------|
| MST3736 | 37" | 36" | 13 | \$607 | +\$58 | +\$90 | — | +\$156 | +\$289 | +\$426 | — | +\$63 |
| MST3742 | 37" | 42" | 15 | \$633 | +\$59 | +\$91 | — | +\$156 | +\$293 | +\$430 | — | +\$65 |
| MST3748 | 37" | 48" | 16 | \$658 | +\$64 | +\$92 | — | +\$157 | +\$296 | +\$435 | — | +\$67 |
| MST3754 | 37" | 54" | 18 | \$681 | +\$66 | +\$98 | — | +\$160 | +\$305 | +\$444 | — | +\$70 |
| MST3760 | 37" | 60" | 19 | \$705 | +\$72 | +\$103 | — | +\$160 | +\$312 | +\$455 | — | +\$72 |

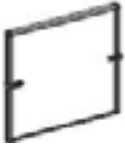

37" H Adjustable
Framed Table
Mounted Screen
Tackable



**PRODUCT CODE
KEY EXAMPLE**

| | |
|----------------------|------------------|
| INSD5136LH-3F | |
| IN | Inscape System |
| SD | Sliding Door |
| 51 | 51" H |
| 36 | 36" W opening |
| LH | Left-handed |
| 3F | 3.5" thick frame |

- Sliding doors consist of polycarbonate material which has naturally occurring variances in the material
- Sliding door includes complete door assembly (trim, polycarbonate material, two door pulls, two 2.5" adjustable casters and top/bottom connector brackets to attach to the panel – optional lock available)
- Black casters
- Locking option available at an upcharge of \$142 per door
- When locking door is specified the crossrail at the 37" H location must be accessible between two tiles for the locking mechanism to function
- See Application Guide for tile configuration to accommodate locking mechanism

NOTES

- Be sure to specify correct sliding door configuration based on the frame it is being installed on
- Sliding doors are specific to frame thickness being installed
- Sliding doors are handed and are based on the direction the door slides to open from front view
- Specify the 36" W sliding door on panel or combination of panels 42" W or greater
- Specify the 42" W sliding door on panel or combination of panels 48" W or greater

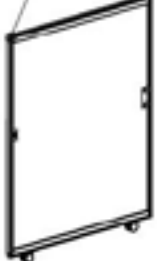
| | | Part number | H | W | Clear fluted / White fluted polycarbonate | Accent paint |
|---|---|----------------------|-----|-----|---|--------------|
|  | 51" H Sliding Door 3.5" Thick Frame | INSD5136LH-3F | 51" | 49" | \$1284 | +\$131 |
| | | INSD5142LH-3F | 51" | 55" | \$1414 | +\$143 |
| | | INSD5136RH-3F | 51" | 49" | \$1284 | +\$131 |
| | | INSD5142RH-3F | 51" | 55" | \$1414 | +\$143 |
|  | 64" H Sliding Door 3.5" Thick Frame | INSD6436LH-3F | 64" | 49" | \$1461 | +\$147 |
| | | INSD6442LH-3F | 64" | 55" | \$1669 | +\$170 |
| | | INSD6436RH-3F | 64" | 49" | \$1461 | +\$147 |
| | | INSD6442RH-3F | 64" | 55" | \$1669 | +\$170 |
|  | 51" H Sliding Door 2.75" Thick Frame | INSD5136LH-2F | 51" | 49" | \$1290 | +\$131 |
| | | INSD5142LH-2F | 51" | 55" | \$1422 | +\$143 |
| | | INSD5136RH-2F | 51" | 49" | \$1290 | +\$131 |
| | | INSD5142RH-2F | 51" | 55" | \$1422 | +\$143 |
|  | 64" H Sliding Door 2.75" Thick Frame | INSD6436LH-2F | 64" | 49" | \$1476 | +\$148 |
| | | INSD6442LH-2F | 64" | 55" | \$1615 | +\$165 |
| | | INSD6436RH-2F | 64" | 49" | \$1476 | +\$148 |
| | | INSD6442RH-2F | 64" | 55" | \$1615 | +\$165 |

Inscape System 2 ½" and 3 ½" frames may be connected in a variety of ways including on and off-module, straight inline, two-way, three-way and four-way configurations. Frames of the same height or frames of differing heights may be connected together. All top caps, end of line trim, and connectors must be specified independently from the frame. To facilitate specification, connectors are available in same height kits which include all connector brackets, plugs, plates, trim clips and finished trim. 90° and 120° connections are achievable with both thickness of panel. When creating frames of varying heights, kits need to be built up. A combination of same height "L", "T" or "X" connections along with Stack-on Connectors and vertical trim will create a finished connection. Begin by connecting all common heights and working up.

A handful of universal connectors create all Inscape System panel configurations for the 2 ¾" and 3 ½" frames. The 1 ½" screen has its own set of connectors which are specific for this thinner screen. A ⅜" Allen Key is all that is required to fasten connector bolts. Trim is constructed of aluminum.

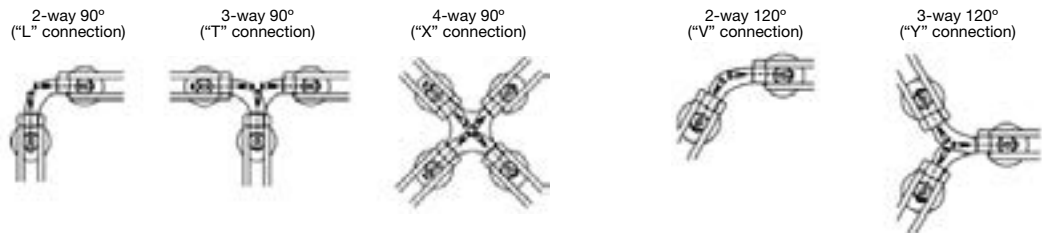

INLINE CONNECTORS

Inline connectors are specified to join two frames together which are in alignment. These connectors are specified based on the height of the panels.

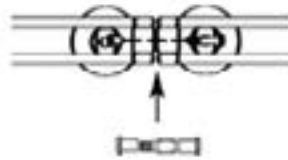

OFF MODULE CONNECTIONS

Off module connections are specific for frame thickness as well as location where the panel will be mounted to the spine. The off-module panel may be positioned at the end of the panel or in the middle of the panel, with the corresponding bracket. Cannot be used with monolithic tiles on spine. See Inscape System Application Guide.

CONNECTION KITS

Connection kits come in a variety of heights and configurations, within 90° and 120° connections and are based on the panel orientation. Within the connection kit, finished trim, panel connector bracket and short bolts are included depending on the configuration specified. Connector kits are panel thickness specific due to the thickness of the finished trim. The brackets and bolts within are part of the universal kit of parts and may be used for either thickness of panel. Special connectors have been structured to connect 3 ½" and 2 ¾" in the same height connections. These are also kitted and include connecting brackets and flat trim profile only. When specifying connections on module and of varying height (when only one thickness of panel is specified) the connection will need to be "built". This can be done by specifying the lowest same height connection and building stack trims to complete the top connection portion. There are a few pre-built connector kits for varying height configurations. Connector kits for Stack-on frames allow for construction of multi height connections.



WALL CONNECTORS

Wall connectors are specified based on the height of the panel attaching to the wall. All hardware is included in order to attach the panel to the wall. This connector is not visible, and sets frame off wall slightly.

END TRIM

End trim is kit structured to include all brackets, bolts and finished trim; Tapered or Flat. Trim profiles are available in two profile options for the 3 1/2" thick frame; Tapered and Flat, and Flat for the 2 3/4" thick frames. When connecting these two thicknesses of frame at a connection, only the Flat trim profile may be specified. Vertical trim heights are available to match all frame heights as well as in four modular heights of 6.75", 13.5", 20.25" and 27". Trim is manufactured from aluminum and always aligns straight and true when frames are connected. All painted aluminum vertical trim and top trim are easily removed to facilitate lay in of cables.

HI-LO TRIM

Hi-Lo trim is designed to be situated at the end of line condition of a higher frame, where the top cap of a lower height frame meets the vertical trim. The profile of the top cap has been scribed from the Hi-Lo trim.

STACK-ON END TRIM

Stack-on end trim is used when a higher frame requires vertical end trim at a connection. Hi-Lo trim may be used in this application for Flat profile trim because there is no 'scribing' that is required for this profile.

TOP CAPS

Top caps are specified separately. Top caps include clips to mount on a frame or combination of two frames as outlined in the Inscape System Application Guide. Painted aluminum profile is available for both thickness of frame. Painted aluminum tapered is available for 3 1/2" thick frame. When spanning two frames when 60" or less in width, two additional Jesters are required to be specified.

1.5" THICK SCREEN CONNECTORS

1 1/2" Thick screen connectors allow for two-way ("L"), three-way ("T"), and four way ("X") connections. Each condition, excluding the inline, includes a 1 1/2" square extruded aluminum connector post and the required number of post connector clips. The inline condition only requires inline connector clips which mount directly into the frames of the adjoining screens to complete the connection. The connector post may be finished in any of the standard Inscape System paint finishes.

Post connector clips are a standard black finish. Universal 1 1/2" connector kits include all required connector hardware and trim necessary to make 'L', 'T' and 'X' connections. Specify one height specific universal connector kit to accommodate any of the three corner conditions. Inline connector kits come complete with the required amount of connector clips.

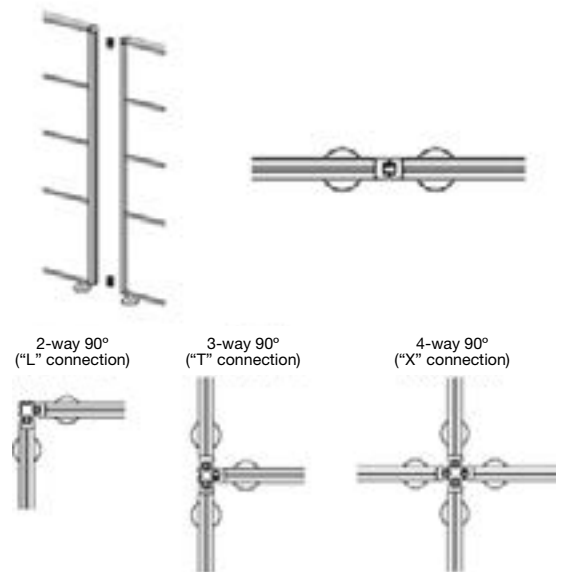

CRENZEA STORAGE BENCHING COMPLIMENT END TRIM

Credenza storage benching compliment end trim is specified where the low height panel is situated between two Credenza Storage cases and end trim is to be specified. This trim is available with cutout or without depending if a power feed needs to enter at that location. The trim can be painted the same color as the cases. Two end trim types have been designed; one to correspond with a lateral top and one for a cushion top. These are specific to the situation in which they are being installed. This is used for 3 1/2" thick application only. See Inscape System Application Guide.

- Connectors and trim are specified independently of frames
- All mounting hardware and finish trim is included for corresponding frame thickness

TOP CAP

- Top caps may span two frames. See Inscape System Application Guide for details
- Top caps up to 60"W requires two additional Jesters to be specified if spanning multiple frames (ie a 60"W top trim installed on 2-30" frames)

END TRIM

- Stack-On End Trim is used when stack frames are specified and full height trim is not specified (whenever possible order full height trims when adding a stack on frame)



- Hi-Lo End trim is used where two frames in alignment are of different heights. The Hi-Lo End trim mounts to the side of the higher panel to finish it off
- Flat Hi-Lo End Trim may also be used in a stack on solution. The flat bottom profile allows for this trim to be used in multiple conditions

NOTES

In order to get a total cost on products when upcharges are present take the list price of the product number and add the upcharge cost shown to the list price.

For example:

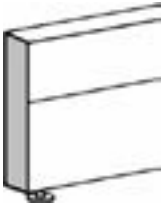
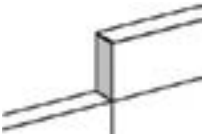
Product INTC18-3F Tapered in an accent paint would be \$44 +\$8



| | Part number | H | Thickness | Tapered | Flat | Accent paint |
|---|-----------------------|--------|-----------|---------|-------|--------------|
|  <p>Top Cap</p> | INTC18-3F | — | 3 1/2" | \$44 | \$44 | +\$8 |
| | INTC24-3F | — | 3 1/2" | \$51 | \$51 | +\$9 |
| | INTC30-3F | — | 3 1/2" | \$60 | \$60 | +\$9 |
| | INTC36-3F | — | 3 1/2" | \$65 | \$65 | +\$10 |
| | INTC42-3F | — | 3 1/2" | \$71 | \$71 | +\$10 |
| | INTC48-3F | — | 3 1/2" | \$73 | \$73 | +\$11 |
| | INTC54-3F | — | 3 1/2" | \$91 | \$91 | +\$12 |
| | INTC60-3F | — | 3 1/2" | \$97 | \$97 | +\$13 |
| | INTC66-3F | — | 3 1/2" | — | \$112 | +\$15 |
| | INTC72-3F | — | 3 1/2" | — | \$118 | +\$15 |
| | INTC78-3F | — | 3 1/2" | — | \$126 | +\$16 |
| | INTC84-3F | — | 3 1/2" | — | \$137 | +\$17 |
| | INTC90-3F | — | 3 1/2" | — | \$141 | +\$17 |
| INTC96-3F | — | 3 1/2" | — | \$144 | +\$18 | |
|  <p>End-of-Line Trim</p> | INET24-3F | 24" | 3 1/2" | \$34 | \$34 | +\$7 |
| | INET29-3F | 29" | 3 1/2" | \$46 | \$46 | +\$8 |
| | INET37-3F | 37" | 3 1/2" | \$54 | \$54 | +\$9 |
| | INET44-3F | 44" | 3 1/2" | \$60 | \$60 | +\$9 |
| | INET51-3F | 51" | 3 1/2" | \$67 | \$67 | +\$10 |
| | INET57-3F | 57" | 3 1/2" | \$79 | \$79 | +\$11 |
| | INET64-3F | 64" | 3 1/2" | \$88 | \$88 | +\$12 |
| | INET78-3F | 78" | 3 1/2" | \$110 | \$110 | +\$15 |
| | INET91-3F | 91" | 3 1/2" | \$134 | \$134 | +\$17 |
|  <p>Hi-Lo End Trim</p> | INETHL6.75-3F | 6.75" | 3 1/2" | \$27 | \$27 | +\$7 |
| | INETHL13.5-3F | 13.5" | 3 1/2" | \$43 | \$43 | +\$8 |
| | INETHL20.25-3F | 20.25" | 3 1/2" | \$51 | \$51 | +\$9 |
| | INETHL27-3F | 27" | 3 1/2" | \$79 | \$79 | +\$11 |
|  <p>Stack-On Trim</p> | INET6.75-3F | 6.75" | 3 1/2" | \$25 | \$25 | +\$6 |
| | INET13.5-3F | 13.5" | 3 1/2" | \$39 | \$39 | +\$8 |
| | INET20.25-3F | 20.25" | 3 1/2" | \$47 | \$47 | +\$8 |
| | INET27-3F | 27" | 3 1/2" | \$73 | \$73 | +\$11 |

Architecture

Connectors and Trim
3 1/2" Thick 90° Connector Kits

System

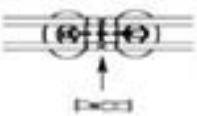
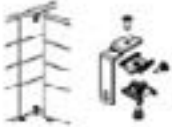
- Inline connectors are required to be specified when frames are connected inline
- Off-module bracket "MP" – when an off-module frame is to be mounted in the middle of the frame (frame thickness specific)
- Off-module bracket "EP" – when an off-module frame is to be mounted at either end of the frame. See application guide
- For back to back off-module applications at either end of a panel, 2x "EP" off-module bracket codes are required
- Two sided off-module brackets are specified when frames are of- module on both sides of the "spine" frame
- Off-module bracket suffix (3F) is based on the frame thickness
- Off-module brackets cannot be used where monolithic tiles are present on spine. The lower bracket requires segmentation in tiles to attach to crossrail
- Specify wall start connector based on the height of the frame (64" to be cut on site when used with 57" high frame)

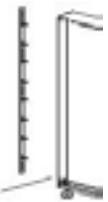
| | Part number | H | List price |
|---|--|----------------------|-------------------------|
|  | Inline Connector Kit | INLINE-1 | All Stack on Frame" \$0 |
| | | INLINE-2 | 24"h - 51"h Frame" \$0 |
| | | INLINE-3 | 57"h - 64"h Frame" \$0 |
| | | INLINE-4 | 71"h - 91"h Frame" \$0 |
|  | Off-Module Bracket | INCPOFM-MP-3F | — \$93 |
| | | INCPOFM-EP | — \$93 |
|  | Off-Module Bracket for two sided application | INCPOFMX-3F | — \$133 |
|  | Wall Start Connector | INCPW2 | 24 & 29" \$208 |
| | | INCPW3 | 37" \$215 |
| | | INCPW4 | 44" \$240 |
| | | INCPW5 | 51" \$263 |
| | | INCPW6 | 57 & 64" \$283 |
| | | INCPW7 | 78" \$288 |
| | | INCPW9 | 91" \$292 |

Architecture

Connectors and Trim

3 1/2" Thick 90° Same Height Connector Kits

System

- Connector kits include connector brackets, bolts, nuts and finished trim to create connection
- Specify code based on height of frames within connection
- The connection kits may be used in conjunction with Stack-on Connectors and vertical trim to create multi-height connections





NOTES

Be sure to specify correct thickness of connector kit based on the frame thickness

In order to get a total cost on products when upcharges are present take the list price of the product number and add the upcharge cost shown to the list price.

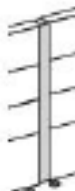
For example:

Product INCPL3300-3F in an accent paint would be \$101 +\$13

| | Part number | H | Thickness | Tapered | Flat | Accent paint | |
|---|-----------------------------|------------------------|-----------|---------|-------|--------------|-------|
|  | Full Height Straight Filler | INCPSLW-3F | 24" | 3 1/2" | \$89 | \$89 | +\$12 |
| | | INCPS2020-3F | 29" | 3 1/2" | \$106 | \$106 | +\$13 |
| | | INCPS3030-3F | 37" | 3 1/2" | \$114 | \$114 | +\$15 |
| | | INCPS4040-3F | 44" | 3 1/2" | \$135 | \$135 | +\$17 |
| | | INCPS5050-3F | 51" | 3 1/2" | \$143 | \$143 | +\$18 |
| | | INCPS57-5050-3F | 57" | 3 1/2" | \$167 | \$167 | +\$20 |
| | | INCPS6060-3F | 64" | 3 1/2" | \$197 | \$197 | +\$22 |
| | | INCPS7070-3F | 78" | 3 1/2" | \$245 | \$245 | +\$26 |
| | | INCPS9090-3F | 91" | 3 1/2" | \$292 | \$292 | +\$31 |
|  | Full Height "L" Connector | INCPLLW-3F | 24" | 3 1/2" | \$72 | \$72 | +\$11 |
| | | INCPL2200-3F | 29" | 3 1/2" | \$93 | \$93 | +\$12 |
| | | INCPL3300-3F | 37" | 3 1/2" | \$101 | \$101 | +\$13 |
| | | INCPL4400-3F | 44" | 3 1/2" | \$107 | \$107 | +\$15 |
| | | INCPL5500-3F | 51" | 3 1/2" | \$119 | \$119 | +\$15 |
| | | INCPL57-5500-3F | 57" | 3 1/2" | \$131 | \$131 | +\$17 |
| | | INCPL6600-3F | 64" | 3 1/2" | \$154 | \$154 | +\$19 |
| | | INCPL7700-3F | 78" | 3 1/2" | \$180 | \$180 | +\$21 |
| | | INCPL9900-3F | 91" | 3 1/2" | \$215 | \$215 | +\$24 |
|  | Full Height "T" Connector | INCPTLW-3F | 24" | 3 1/2" | \$93 | \$93 | +\$12 |
| | | INCPT2220-3F | 29" | 3 1/2" | \$138 | \$138 | +\$17 |
| | | INCPT3330-3F | 37" | 3 1/2" | \$147 | \$147 | +\$18 |
| | | INCPT4440-3F | 44" | 3 1/2" | \$159 | \$159 | +\$19 |
| | | INCPT5550-3F | 51" | 3 1/2" | \$165 | \$165 | +\$19 |
| | | INCPT57-5550-3F | 57" | 3 1/2" | \$197 | \$197 | +\$22 |
| | | INCPT6660-3F | 64" | 3 1/2" | \$218 | \$218 | +\$24 |
| | | INCPT7770-3F | 78" | 3 1/2" | \$265 | \$265 | +\$29 |
| | | INCPT9990-3F | 91" | 3 1/2" | \$305 | \$305 | +\$33 |
|  | "X" Connector | INCPXLW-3F | 24" | 3 1/2" | \$131 | \$131 | +\$17 |
| | | INCPX2222-3F | 29" | 3 1/2" | \$178 | \$178 | +\$21 |
| | | INCPX3333-3F | 37" | 3 1/2" | \$191 | \$191 | +\$22 |
| | | INCPX4444-3F | 44" | 3 1/2" | \$198 | \$198 | +\$22 |
| | | INCPX5555-3F | 51" | 3 1/2" | \$204 | \$204 | +\$23 |
| | | INCPX57-5555-3F | 57" | 3 1/2" | \$219 | \$219 | +\$24 |
| | | INCPX6666-3F | 64" | 3 1/2" | \$235 | \$235 | +\$25 |
| | | INCPX7777-3F | 78" | 3 1/2" | \$258 | \$258 | +\$27 |
| | | INCPX9999-3F | 91" | 3 1/2" | \$288 | \$288 | +\$31 |

Architecture

Connectors and Trim

3 1/2" Thick 90° Stack-on Connector Kits

System

- Available in heights matching incremental change of frame heights; 6.75", 13.5", 20.25" and 27" H
- Specify based on configuration requirement
- May be used in conjunction with same height kits and end trim to create multi height configurations



NOTES

Be sure to specify correct thickness of connector kit based on the frame thickness

In order to get a total cost on products when upcharges are present take the list price of the product number and add the upcharge cost shown to the list price.

For example:

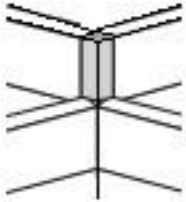
Product INCPT13.5-3F in an accent paint would be \$46 +\$8

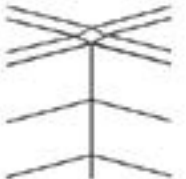
| | Part number | H | Thickness | Tapered | Flat | Accent paint | |
|---|----------------------------|----------------------|-----------|---------|-------|--------------|-------|
|  | Straight Filler Connection | INCPS6.75-3F | 6.75" | 3 1/2" | \$32 | \$32 | +\$7 |
| | | INCPS13.5-3F | 13.5" | 3 1/2" | \$57 | \$57 | +\$9 |
| | | INCPS20.25-3F | 20.25" | 3 1/2" | \$91 | \$91 | +\$12 |
| | | INCPS27-3F | 27" | 3 1/2" | \$102 | \$102 | +\$13 |
|  | "L" Connection | INCPL6.75-3F | 6.75" | 3 1/2" | \$29 | \$29 | +\$7 |
| | | INCPL13.5-3F | 13.5" | 3 1/2" | \$46 | \$46 | +\$8 |
| | | INCPL20.25-3F | 20.25" | 3 1/2" | \$70 | \$70 | +\$10 |
| | | INCPL27-3F | 27" | 3 1/2" | \$91 | \$91 | +\$12 |
|  | "T" Connection | INCPT6.75-3F | 6.75" | 3 1/2" | \$29 | \$29 | +\$7 |
| | | INCPT13.5-3F | 13.5" | 3 1/2" | \$46 | \$46 | +\$8 |
| | | INCPT20.25-3F | 20.25" | 3 1/2" | \$71 | \$71 | +\$10 |
| | | INCPT27-3F | 27" | 3 1/2" | \$91 | \$91 | +\$12 |
|  | "X" Connection | INCPX6.75-3F | 6.75" | 3 1/2" | \$20 | \$20 | +\$6 |
| | | INCPX13.5-3F | 13.5" | 3 1/2" | \$25 | \$25 | +\$6 |
| | | INCPX20.25-3F | 20.25" | 3 1/2" | \$29 | \$29 | +\$7 |
| | | INCPX27-3F | 27" | 3 1/2" | \$32 | \$32 | +\$7 |

Architecture





Connectors and Trim
3 1/2" Thick 120° Connector Kits

System

- Connector kits include connector brackets, bolts, nuts and finished trim to create connection
- Specify code based on height of frames within connection

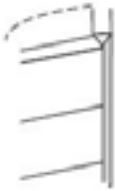
NOTES

Be sure to specify correct thickness of connector kit based on the frame thickness

| | Part number | H | Thickness | Tapered | Flat | Accent paint | |
|---|--------------------------------------|-----------------------|-----------|---------|-------|--------------|-------|
|  | Full Height "V" Connection | INCPV220-3F | 29" | 3 1/2" | \$169 | \$169 | +\$20 |
| | | INCPV330-3F | 37" | 3 1/2" | \$178 | \$178 | +\$21 |
| | | INCPV440-3F | 44" | 3 1/2" | \$188 | \$188 | +\$21 |
| | | INCPV550-3F | 51" | 3 1/2" | \$198 | \$198 | +\$22 |
| | | INCPV57-550-3F | 57" | 3 1/2" | \$210 | \$210 | +\$23 |
| | | INCPV660-3F | 64" | 3 1/2" | \$229 | \$229 | +\$25 |
|  | Full Height "Y" Connection | INCPY222-3F | 29" | 3 1/2" | \$318 | \$318 | +\$34 |
| | | INCPY333-3F | 37" | 3 1/2" | \$328 | \$328 | +\$34 |
| | | INCPY444-3F | 44" | 3 1/2" | \$343 | \$343 | +\$36 |
| | | INCPY555-3F | 51" | 3 1/2" | \$368 | \$368 | +\$39 |
| | | INCPY57-555-3F | 57" | 3 1/2" | \$443 | \$443 | +\$47 |
| | | INCPY666-3F | 64" | 3 1/2" | \$511 | \$511 | +\$53 |
|  | Stack-On "V" Connection | INCPV6.75-3F | 6.75" | 3 1/2" | \$178 | \$178 | +\$21 |
| | | INCPV13.5-3F | 13.5" | 3 1/2" | \$188 | \$188 | +\$21 |
| | | INCPV20.25-3F | 20.25" | 3 1/2" | \$198 | \$198 | +\$22 |
| | | INCPV27-3F | 27" | 3 1/2" | \$210 | \$210 | +\$23 |
|  | Stack-On "Y" Connection | INCPY6.75-3F | 6.75" | 3 1/2" | \$18 | \$18 | +\$6 |
| | | INCPY13.5-3F | 13.5" | 3 1/2" | \$25 | \$25 | +\$6 |
| | | INCPY20.25-3F | 20.25" | 3 1/2" | \$29 | \$29 | +\$7 |
| | | INCPY27-3F | 27" | 3 1/2" | \$32 | \$32 | +\$7 |
|  | 120° Stack-On End Trim, Multi Height | INST6.75Y-3F | 6.75" | 3 1/2" | \$178 | \$178 | +\$21 |
| | | INST13.5Y-3F | 13.5" | 3 1/2" | \$188 | \$188 | +\$21 |
| | | INST20.25Y-3F | 20.25" | 3 1/2" | \$198 | \$198 | +\$22 |
| | | INST27Y-3F | 27" | 3 1/2" | \$210 | \$210 | +\$23 |

- Connectors and trim are specified independently of frames
- All mounting hardware and finish trim is included for corresponding frame thickness
- 2 3/4" thickness is not available in the tapered profile

TOP CAP

- Top caps may span two frames. See Inscape System Application Guide for details
- Top caps up to 60" w requires two additional Jesters to be specified if spanning multiple frames (ie a 60"W top trim installed on 2-30" frames).

END TRIM



- Hi-Lo End trim is used where two frames in alignment are of different heights. The Hi-Lo End trim mounts to the side of the higher panel to finish it off
- Flat Hi-Lo End Trim may also be used in a stack on solution. The flat bottom profile allows for this trim to be used in multiple conditions

NOTES

In order to get a total cost on products when upcharges are present take the list price of the product number and add the upcharge cost shown to the list price.

For example:

Product INTC18-2F in an accent paint would be \$44 +\$8

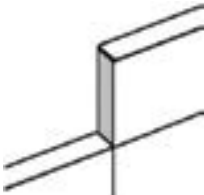

| | Part number | H | Thickness | Tapered | Flat | Accent paint |
|---|-----------------------|--------|-----------|---------|-------|--------------|
|  <p>Top Cap</p> | INTC18-2F | — | 2 3/4" | — | \$44 | +\$8 |
| | INTC24-2F | — | 2 3/4" | — | \$51 | +\$9 |
| | INTC30-2F | — | 2 3/4" | — | \$60 | +\$9 |
| | INTC36-2F | — | 2 3/4" | — | \$65 | +\$10 |
| | INTC42-2F | — | 2 3/4" | — | \$71 | +\$10 |
| | INTC48-2F | — | 2 3/4" | — | \$73 | +\$11 |
| | INTC54-2F | — | 2 3/4" | — | \$91 | +\$12 |
| | INTC60-2F | — | 2 3/4" | — | \$97 | +\$13 |
| | INTC66-2F | — | 2 3/4" | — | \$112 | +\$15 |
| | INTC72-2F | — | 2 3/4" | — | \$118 | +\$15 |
| | INTC78-2F | — | 2 3/4" | — | \$126 | +\$16 |
| | INTC84-2F | — | 2 3/4" | — | \$137 | +\$17 |
| | INTC90-2F | — | 2 3/4" | — | \$141 | +\$17 |
| | INTC96-2F | — | 2 3/4" | — | \$144 | +\$18 |
|  <p>End-of-Line Trim</p> | INET24-2F | 24" | 2 3/4" | — | \$34 | +\$7 |
| | INET29-2F | 29" | 2 3/4" | — | \$46 | +\$8 |
| | INET37-2F | 37" | 2 3/4" | — | \$54 | +\$9 |
| | INET44-2F | 44" | 2 3/4" | — | \$60 | +\$9 |
| | INET51-2F | 51" | 2 3/4" | — | \$67 | +\$10 |
| | INET57-2F | 57" | 2 3/4" | — | \$79 | +\$11 |
| | INET64-2F | 64" | 2 3/4" | — | \$88 | +\$12 |
| | INET78-2F | 78" | 2 3/4" | — | \$110 | +\$15 |
| | INET91-2F | 91" | 2 3/4" | — | \$134 | +\$17 |
|  <p>Hi-Lo End Trim</p> | INETHL6.75-2F | 6.75" | 2 3/4" | — | \$27 | +\$7 |
| | INETHL13.5-2F | 13.5" | 2 3/4" | — | \$43 | +\$8 |
| | INETHL20.25-2F | 20.25" | 2 3/4" | — | \$51 | +\$9 |
| | INETHL27-2F | 27" | 2 3/4" | — | \$79 | +\$11 |

Architecture

Connectors and Trim
2 3/4" Thick 90° Connector Kits

System

- Inline connectors are required to be specified when frames are connected inline
- Off-module bracket "MP" – when an off-module frame is to be mounted in the middle of the frame thickness specific)
- Off-module bracket "EP" – when an off-module frame is to be mounted at either end of the frame. See application guide
- For back to back off-module applications at either end of a panel, 2x "EP" off-module bracket codes are required
- Two sided off-module brackets are specified when frames are of- module on both sides of the "spine" frame
- Off-module bracket suffix (2F) is based on the frame thickness
- Off-module brackets cannot be used where monolithic tiles are present on spine. The lower bracket requires segmentation in tiles to attach to crossrail
- Specify wall start connector based on the height of the frame (64" to be cut on site when used with 57" H frame)

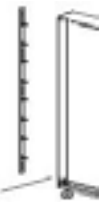
| | Part number | H | List price |
|---|--|---------------------|-------------------------|
|  | Inline Connector Kit | INLINE-1 | All Stack on Frame" \$0 |
| | | INLINE-2 | 24"h - 51"h Frame" \$0 |
| | | INLINE-3 | 57"h - 64"h Frame" \$0 |
| | | INLINE-4 | 71"h - 91"h Frame" \$0 |
|  | Off-Module Bracket | INCPFM-MP-2F | — \$94 |
| | | INCPFM-EP | — \$93 |
|  | Off-Module Bracket for two sided application | INCPFMX-2F | — \$133 |
|  | Wall Start Connector | INCPW2 | 24 & 29" \$208 |
| | | INCPW3 | 37" \$215 |
| | | INCPW4 | 44" \$240 |
| | | INCPW5 | 51" \$263 |
| | | INCPW6 | 57 & 64" \$283 |
| | | INCPW7 | 78" \$288 |
| | | INCPW9 | 91" \$292 |

Architecture

Connectors and Trim

2 3/4" Thick 90° Same Height Connector Kits

System

- Configurations include all hardware and finished trim to create the configuration
- Specify code based on height of frames within connection
- The connection kits may be used in conjunction with Stack-on Connectors and vertical trim to create multi-height connections



NOTES

Be sure to specify correct thickness of connector kit based on the frame thickness

In order to get a total cost on products when upcharges are present take the list price of the product number and add the upcharge cost shown to the list price.

For example:

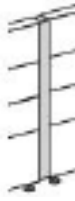
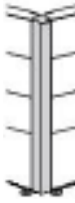
Product INCPL3300-2F in an accent paint would be \$145 +\$18

| | | Part number | H | Thickness | Tapered | Flat | Accent paint |
|---|---------------------------------------|------------------------|-----|-----------|---------|-------|--------------|
|  | Full Height Straight Filler Connector | INCPSLW-2F | 24" | 2 3/4" | — | \$89 | +\$12 |
| | | INCPS2020-2F | 29" | 2 3/4" | — | \$106 | +\$13 |
| | | INCPS3030-2F | 37" | 2 3/4" | — | \$114 | +\$15 |
| | | INCPS4040-2F | 44" | 2 3/4" | — | \$135 | +\$17 |
| | | INCPS5050-2F | 51" | 2 3/4" | — | \$143 | +\$18 |
| | | INCPS57-5050-2F | 57" | 2 3/4" | — | \$167 | +\$20 |
| | | INCPS6060-2F | 64" | 2 3/4" | — | \$197 | +\$22 |
|  | Full Height "L" Connector | INCPLLW-2F | 24" | 2 3/4" | — | \$129 | +\$16 |
| | | INCPL2200-2F | 29" | 2 3/4" | — | \$134 | +\$17 |
| | | INCPL3300-2F | 37" | 2 3/4" | — | \$145 | +\$18 |
| | | INCPL4400-2F | 44" | 2 3/4" | — | \$157 | +\$19 |
| | | INCPL5500-2F | 51" | 2 3/4" | — | \$165 | +\$19 |
| | | INCPL57-5500-2F | 57" | 2 3/4" | — | \$242 | +\$26 |
| | | INCPL6600-2F | 64" | 2 3/4" | — | \$251 | +\$27 |
|  | Full Height "T" Connector | INCPTLW-2F | 24" | 2 3/4" | — | \$93 | +\$12 |
| | | INCPT2220-2F | 29" | 2 3/4" | — | \$138 | +\$17 |
| | | INCPT3330-2F | 37" | 2 3/4" | — | \$147 | +\$18 |
| | | INCPT4440-2F | 44" | 2 3/4" | — | \$159 | +\$19 |
| | | INCPT5550-2F | 51" | 2 3/4" | — | \$165 | +\$19 |
| | | INCPT57-5550-2F | 57" | 2 3/4" | — | \$197 | +\$22 |
| | | INCPT6660-2F | 64" | 2 3/4" | — | \$218 | +\$24 |
|  | "X" Connector | INCPXLW-2F | 24" | 2 3/4" | — | \$131 | +\$17 |
| | | INCPX2222-2F | 29" | 2 3/4" | — | \$178 | +\$21 |
| | | INCPX3333-2F | 37" | 2 3/4" | — | \$191 | +\$22 |
| | | INCPX4444-2F | 44" | 2 3/4" | — | \$198 | +\$22 |
| | | INCPX5555-2F | 51" | 2 3/4" | — | \$204 | +\$23 |
| | | INCPX57-5555-2F | 57" | 2 3/4" | — | \$219 | +\$24 |
| | | INCPX6666-2F | 64" | 2 3/4" | — | \$235 | +\$25 |

Architecture

Connectors and Trim

2 3/4" Thick 90° Stack-on Connector Kits

System

- Available in heights matching incremental change of frame heights; 6.75", 13.5", 20.25" and 27" H
- Specify based on configuration requirement
- May be used in conjunction with same height kits and end trim to create multi height configurations

NOTES

Be sure to specify correct thickness of connector kit based on the frame thickness

In order to get a total cost on products when upcharges are present take the list price of the product number and add the upcharge cost shown to the list price.

For example:

Product INCPL13.5-2F in an accent paint would be \$67 +\$10

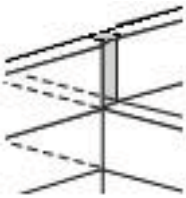
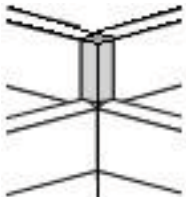
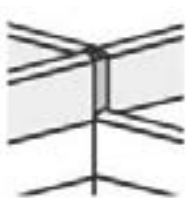
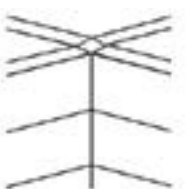
| | Part number | H | Thickness | Tapered | Flat | Accent paint |
|---|----------------------------|--------|-----------|---------|------|--------------|
|  | Straight Filler Connection | | | | | |
| | INCPS6.75-2F | 6.75" | 2 3/4" | — | \$32 | +\$7 |
| | INCPS13.5-2F | 13.5" | 2 3/4" | — | \$57 | +\$9 |
| | INCPS20.25-2F | 20.25" | 2 3/4" | — | \$91 | +\$12 |
|  | "L" Connection | | | | | |
| | INCPL6.75-2F | 6.75" | 2 3/4" | — | \$39 | +\$8 |
| | INCPL13.5-2F | 13.5" | 2 3/4" | — | \$67 | +\$10 |
| | INCPL20.25-2F | 20.25" | 2 3/4" | — | \$99 | +\$13 |
|  | "T" Connection | | | | | |
| | INCPT6.75-2F | 6.75" | 2 3/4" | — | \$29 | +\$7 |
| | INCPT13.5-2F | 13.5" | 2 3/4" | — | \$46 | +\$8 |
| | INCPT20.25-2F | 20.25" | 2 3/4" | — | \$71 | +\$10 |
|  | "X" Connection | | | | | |
| | INCPX6.75-2F | 6.75" | 2 3/4" | — | \$20 | +\$6 |
| | INCPX13.5-2F | 13.5" | 2 3/4" | — | \$25 | +\$6 |
| | INCPX20.25-2F | 20.25" | 2 3/4" | — | \$29 | +\$7 |
| | INCPX27-2F | 27" | 2 3/4" | — | \$32 | +\$7 |

Architecture



Connectors and Trim
2 3/4" Thick 120° Connector Kits

System

- Connector kits include connector brackets, bolts, nuts and finished trim to create connection
- Specify code based on height of frames within connection

NOTES

Be sure to specify correct thickness of connector kit based on the frame thickness

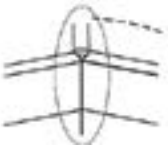
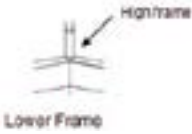

| | Part number | H | Thickness | Flat/ base price | Accent paint | |
|---|---|-----------------------|-----------|---------------------|-----------------|-------|
|  | Full Height "V" Connector | INCPV220-2F | 29" | 2 3/4" | \$169 | +\$20 |
| | | INCPV330-2F | 37" | 2 3/4" | \$178 | +\$21 |
| | | INCPV440-2F | 44" | 2 3/4" | \$188 | +\$21 |
| | | INCPV550-2F | 51" | 2 3/4" | \$198 | +\$22 |
| | | INCPV57-550-2F | 57" | 2 3/4" | \$210 | +\$23 |
| | | INCPV660-2F | 64" | 2 3/4" | \$229 | +\$25 |
|  | Full Height "Y" Connector | INCPY222-2F | 29" | 2 3/4" | \$318 | +\$34 |
| | | INCPY333-2F | 37" | 2 3/4" | \$328 | +\$34 |
| | | INCPY444-2F | 44" | 2 3/4" | \$343 | +\$36 |
| | | INCPY555-2F | 51" | 2 3/4" | \$368 | +\$39 |
| | | INCPY57-555-2F | 57" | 2 3/4" | \$443 | +\$47 |
| | | INCPY666-2F | 64" | 2 3/4" | \$511 | +\$53 |
|  | Stack-On "V" Connector | INCPV6.75-2F | 6.75" | 2 3/4" | \$180 | +\$21 |
| | | INCPV13.5-2F | 13.5" | 2 3/4" | \$189 | +\$22 |
| | | INCPV20.25-2F | 20.25" | 2 3/4" | \$198 | +\$22 |
| | | INCPV27-2F | 27" | 2 3/4" | \$210 | +\$23 |
| | | INCPV10-2F | 10.125" | 2 3/4" | \$185 | +\$21 |
|  | Stack-On "Y" Connector | INCPY6.75-2F | 6.75" | 2 3/4" | \$20 | +\$6 |
| | | INCPY13.5-2F | 13.5" | 2 3/4" | \$25 | +\$6 |
| | | INCPY20.25-2F | 20.25" | 2 3/4" | \$29 | +\$7 |
| | | INCPY27-2F | 27" | 2 3/4" | \$32 | +\$7 |
| | | INCPY10-2F | 10.125" | 2 3/4" | \$22 | +\$6 |
|  | 120° Stack-On End Trim, Multi Height | INST6.75Y-2F | 6.75" | 2 3/4" | \$180 | +\$21 |
| | | INST13.5Y-2F | 13.5" | 2 3/4" | \$189 | +\$22 |
| | | INST20.25Y-2F | 20.25" | 2 3/4" | \$198 | +\$22 |
| | | INST27Y-2F | 27" | 2 3/4" | \$210 | +\$23 |
| | | INST10Y-2F | 10.125" | 2 3/4" | \$185 | +\$21 |

Architecture

Connectors and Trim
1 1/2" Thick Screen Connectors

System

- Inline Connectors differ from those of the Inscape System panel
- Universal connectors are self finished and solve all L, T and X connections
- Specify universal connector code based on height of the frames within connection

| | Part number | H | Neutral paint/ base price | Accent paint |
|---|---------------|-------------------------------------|------------------------------|-----------------|
|  | FSSC | 3 ⁷ / ₄ "/51" | \$29 | — |
| | FSSC64 | 64" | \$42 | — |
|  | FSUC37 | 37" | \$121 | +\$16 |
| | FSUC44 | 44" | \$130 | +\$16 |
| | FSUC51 | 51" | \$137 | +\$17 |
| | FSUC64 | 64" | \$185 | +\$21 |
|  | CFW | — | \$48 | — |

Architecture

Connectors and Trim





1 1/2" Screen to 3 1/2" Frame Connector Kits

System

- Configurations include all hardware and finished trim to create the configuration
- Two sided off-module brackets are specified when frames are off module on both sides of the "spine" panel
- Specify code based on height of frames within connection
- The connection kits may be used in conjunction with Stack-on Connectors and vertical trim to create multi-height connections
- 1.5" screen connectors are available for tapered trim only
- **(3F)** suffix is based on the spine panel thickness

NOTES

Be sure to specify correct thickness of connector kit based on the frame thickness

| | | Part number | H | Wt (lbs) | Neutral paint/ base price | Accent paint |
|---|--|-----------------------|-----|----------|------------------------------|-----------------|
|  | Off-Module (1side) | INFSPOMC-3F | — | 2 | \$103 | — |
|  | Off-Module (2side) screens must be off module at same locations on spine back to back | INFSPOMB-3F | — | 2 | \$156 | — |
|  | "L" Connector 1 1/2" left side | INFSPLC37LH-3F | 37" | 2 | \$139 | +\$17 |
| | | INFSPLC44LH-3F | 44" | 2 | \$148 | +\$18 |
| | | INFSPLC51LH-3F | 51" | 2 | \$152 | +\$18 |
| | | INFSPLC64LH-3F | 64" | 2 | \$192 | +\$22 |
|  | "L" Connector 1 1/2" right side | INFSPLC37RH-3F | 37" | 2 | \$139 | +\$17 |
| | | INFSPLC44RH-3F | 44" | 2 | \$148 | +\$18 |
| | | INFSPLC51RH-3F | 51" | 2 | \$152 | +\$18 |
| | | INFSPLC64RH-3F | 64" | 2 | \$192 | +\$22 |

Architecture

Connectors and Trim



1 1/2" Screen to 3 1/2" Frame Connector Kits

System

- Configurations include all hardware and finished trim to create the configuration
- Specify code based on height of frames within connection
- The connection kits may be used in conjunction with Stack-on Connectors and vertical trim to create multi-height connections
- 1.5" screen connectors are available for tapered trim only
- **(3F)** suffix is based on the spine panel thickness.

NOTES

Be sure to specify correct thickness of connector kit based on the frame thickness

| | | Part number | H | Wt (lbs) | Neutral paint/ base price | Accent paint |
|--|--|---------------------|-----|----------|------------------------------|-----------------|
|  | "T" Connector 1x3 1/2" Frame | INFPSTC37-3F | 37" | 2 | \$174 | +\$20 |
| | | INFPSTC44-3F | 44" | 2 | \$180 | +\$21 |
| | | INFPSTC51-3F | 51" | 2 | \$199 | +\$22 |
| | | INFPSTC64-3F | 64" | 2 | \$223 | +\$25 |
|  | "X" Connection 2x1 1/2" Screens, 2x3 1/2" Frames | INFPSXC37-3F | 37" | 2 | \$111 | +\$15 |
| | | INFPSXC44-3F | 44" | 2 | \$114 | +\$15 |
| | | INFPSXC51-3F | 51" | 2 | \$118 | +\$15 |
| | | INFPSXC64-3F | 64" | 2 | \$121 | +\$16 |

Architecture

Connectors and Trim

2 3/4" Frame to 3 1/2" Frame Same Height Connector Kits

System

- Configurations include all hardware and finished trim to create the configuration
- Specify code based on height of frames within connection
- The connection kits may be used in conjunction with Stack-on Connectors and vertical trim to create multi-height connections

NOTES

- Number in diagrams depict panel thickness
- Lefts and rights are determined from the inside view of the connection

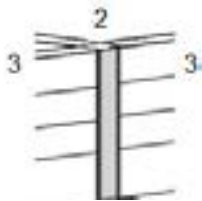





| | Part number | H | Thickness | Neutral paint/ base price | Accent paint |
|---|--------------------|-----|-----------|------------------------------|-----------------|
| "T" Connector 2x3 1/2" Frame, 1x2 3/4" Frames | INMHC24-332 | 24" | 2 3/4" | \$170 | +\$20 |
| | INMHC29-332 | 29" | 2 3/4" | \$172 | +\$20 |
| | INMHC37-332 | 37" | 2 3/4" | \$179 | +\$21 |
| | INMHC44-332 | 44" | 2 3/4" | \$185 | +\$21 |
| | INMHC51-332 | 51" | 2 3/4" | \$191 | +\$22 |
| | INMHC57-332 | 57" | 2 3/4" | \$197 | +\$22 |
| | INMHC64-332 | 64" | 2 3/4" | \$289 | +\$31 |

Architecture

Connectors and Trim
Planna Storage Benching End Trim

System

- Includes mounting hardware to attach to the adjacent storage cases
- 3 1/2" thick version only
- Specific for worksurface or cushion above storage
- Specify whether a cutout is required to allow electrical feed and data cabling to enter frame behind

| | | Part number | H | W | Wt (lbs) | Neutral paint/ base price | Accent paint |
|---|---|---------------------|-----|------|----------|------------------------------|-----------------|
|  | End Trim with Electrical Cutout, Worksurface compatible (worksurface above) | PLNCETCO | 25" | 3.5" | 2 | \$91 | +\$12 |
|  | End Trim without Cutout / Private Office Case Back Filler, Worksurface compatible (worksurface above) | PLNCET | 25" | 3.5" | 2 | \$88 | +\$12 |
|  | End Trim with Electrical Cutout, Cushion compatible (cushion above) | PLNCETCOCUSH | 25" | 3.5" | 2 | \$73 | +\$11 |
|  | End Trim without Cutout / Private Office Case Back Filler, Cushion compatible (cushion above) | PLNCETCUSH | 25" | 3.5" | 2 | \$69 | +\$10 |

Tiles are available as fabric, painted, tackable, Nuform, Double Glazed and whiteboard. Tiles are interchangeable between 2.75" and 3.5" frame thickness (the thickness of the frame is determined by the tile clips which come with the frame). Tile heights vary and must always align with a crossrail on the frame as this is where the tile clips are located. If alternative tile configurations are required, additional crossrails may be specified separately and installed in the field (crossrails will include tile clips depending on thickness opted for). Tiles may be positioned in any location unless otherwise stated or crossrail does not permit.

Tiles are held in place by tile clips. These clips snap between panel crossrails and may easily be removed and/or replaced if necessary when changing the thickness of the panel. Clips support panel tiles and top trim. The clips are made of Delrin which is a resin similar to nylon in strength but has more rigidity and superior memory. These characteristics allow the Inscape System clips to retain their original shape without permanently deforming under continual pressure. This ensures tiles and trim will snap into place with a solid "click" time after time.

FABRIC AND PAINTED TILES

Fabric and painted tiles are available 27", 20.25" and 6.75" H, as well as 13.5" and are constructed from 24 gauge galvanized steel. Powder-coated and fabric-covered steel tiles have a flame spread rating of less than 200 when tested according to ASTM-E84. Fabric-covered tiles are available in standard fabrics or COM. COM fabrics are subject to approval. White or extremely light colored COM fabrics will incur an upcharge of 25% to the tile pricing with which the fabric is being applied. This is due to special handling of the fabric and tiles, in addition to painting of the tiles. Painted tiles are available in the colors shown in our Color Guide and are available in the following styles: plain steel, perforated, and steel screen. Fabric on tiles is applied in a railroad orientation.

TACKABLE TILES

Tackable tiles are constructed from 24 gauge cold rolled steel with a paint finish on all surfaces to prevent corrosion. The same general rules from the fabric tile section apply to the Tackable tiles. Fabric on tiles is applied in a railroad orientation. NRC 0.57, STC 9.

Tackable Acoustical tiles are available through Standard Specials with NRC of .73 and an STC of 12.

Nuform Tiles consist of gray melamine-backed MDF substrate 0.375" thick, with vacuum-formed Nuform foil over the front's surface and sides. The back-side of the tile also has routing features that accept zinc die-cast tile clips. All Nuform tiles incorporate a stiffener on the rear of the tile to ensure straightness and rigidity. This stiffener limits where the tile may be placed on a 2.75" thick frame. Nuform tiles cannot be specified in a location where a power track is installed due to interference. A sticker on the back of Nuform tiles provides UL flame / smoke-rating information. Woodgrain pattern is vertical. Due to limitations in the foil size, 48" and wider tiles are not available in F06 Walnut.

WHITEBOARD TILES

Whiteboard tiles are available in two heights, 13.5" and 20.25". Tiles are constructed from 24 gauge cold rolled steel with optional white, gray or black paint finishes that has been specifically formulated for dry erase markers. Whiteboards are seamless and fit same locations as standard painted tiles.

NOTE: Inscape whiteboards are specifically designed for use with DRY-ERASE markers only. WHITEBOARDS ARE NOT INTENDED FOR USE WITH PERMANENT MARKERS. Inscape advises the use of Sanford Expo Dry Erase markers with whiteboards. For a thorough cleaning, use Sanford Expo spray cleaner.

PAPER MANAGEMENT TILES

Paper management tiles support horizontal paper management accessories. Organizers may be positioned at any point along the width of the tile. Three slats structured into the tile allow for three different height options for the accessories to be installed. Accessories may be found under Horizontal Accessories under the "Storage and Accessories" section. Maximum load capacity is 75lbs. When specifying paper management tiles which will be supporting a monitor arm, a Paper Management Reinforcing kit is required for additional structure. The 54" and 60" w tiles are pre-structured with these kits.

PERFORATED TILES

Perforated tiles are constructed of 24 gauge galvanized steel, the Steel Screen tiles are constructed from 24 gauge cold rolled steel. Tiles may be painted in any of Inscape's standard colors or color matches.

COMMUNICATION TILES

Communication tiles provide power OR data access. The 24" and 30" W include one cutout while all wider tile widths include two cutouts. Tiles provide electrical access in frames 30"w and wider only and data access in all panel widths. Bezels in tile may be specified in black, white (close match to P290 – Aluminum Leaf) and gray (close match to P326 – Moonlight) as well with the data or electrical components. Bezels are flush with tile, NOT recessed.

FABRIC/FINISHES & WORKSURFACE GENERAL NOTES

Fabric patterns which are available in 54" and 55" both have limitations on the sizes of tiles available. Tile sizes longer than 42" are not available.

Codes with the following suffix have specific install locations

| | |
|-----------|------------|
| UD | Upper Deck |
| BL | Beltline |
| BS | Base |

MULTI ACCESS TILES

Multi access tiles provide electrical AND data access. Cutouts align with power track and proper tiles must be specified in specific areas if stated. Data and Electrical components may be specified from the Technology section. Bezels in tile may be specified in black, white (close match to P168 – Glacier White) and gray (close match to P290 – Aluminum Leaf) as well with the data or electrical components. Bezels are flush with tile, NOT recessed.

Codes with the following suffix have specific install locations

| | |
|-----------|------------|
| UD | Upper Deck |
| BL | Beltline |
| BS | Base |

MONOLITHIC TILES

Monolithic tiles are specified based on the height and width of the frame with which they are being installed. Monolithic tiles are available in painted or fabric (fabric wrapped steel).

DOUBLE GLAZED TILES

Double glazed tiles are available in 13.5" H and may be installed on frames 24" to 48" W in place of a tile. Double Glazed tiles feature a double pane of frosted acrylic or clear acrylic framed by vertical and horizontal trim. Double Glazed tiles may be installed one on top of another. If wider than 60" of glaze is desired; Stack on Double Glazed Kits may be specified.

PLANNA MULTI ACCESS TILE

The Planna multi access tile is required for termination of electrical and data at points behind the Planna case. The multi access tile can be optioned in any standard paint color. The multi access tile designed for Planna includes proper hardware to mount the tile to the frame. Be sure to specify electrical components such as the Upper Deck electrical kit, duplexes and phone/ data components separately.

This tile is only structured in conjunction with the 3.5" thickness.

LEGEND

● Available



| Tile Height & Type | | Tile Width | | | | | | | | | | | | | |
|--------------------|---------------------------------|------------|-----|-----|-----|-----|-----|-----|-----|-----|-----|-----|-----|-----|-----|
| | | 18" | 24" | 30" | 36" | 42" | 48" | 54" | 60" | 66" | 72" | 78" | 84" | 90" | 96" |
| 6.75"H | Painted | ● | ● | ● | ● | ● | ● | ● | ● | | | | | | |
| 13.5"H | Painted | ● | ● | ● | ● | ● | ● | ● | ● | ● | ● | ● | ● | ● | ● |
| 20.25"H | Painted | ● | ● | ● | ● | ● | ● | ● | ● | ● | ● | ● | ● | ● | ● |
| 27"H | Painted | ● | ● | ● | ● | ● | ● | ● | ● | | | | | | |
| 37"H | Monolithic painted | ● | ● | ● | ● | ● | ● | ● | ● | | | | | | |
| 44"H | Monolithic painted | ● | ● | ● | ● | ● | ● | ● | ● | | | | | | |
| 51"H | Monolithic painted | ● | ● | ● | ● | ● | ● | ● | ● | | | | | | |
| 57"H | Monolithic painted | ● | ● | ● | ● | ● | ● | ● | ● | | | | | | |
| 64"H | Monolithic painted | ● | ● | ● | ● | ● | ● | ● | ● | | | | | | |
| 6.75"H | Fabric | ● | ● | ● | ● | ● | ● | ● | ● | | | | | | |
| 13.5"H | Fabric | ● | ● | ● | ● | ● | ● | ● | ● | ● | ● | ● | ● | ● | ● |
| 20.25"H | Fabric | ● | ● | ● | ● | ● | ● | ● | ● | ● | ● | ● | ● | ● | ● |
| 27"H | Fabric | ● | ● | ● | ● | ● | ● | | | | | | | | |
| 37"H | Monolithic fabric | ● | ● | ● | ● | ● | ● | | | | | | | | |
| 44"H | Monolithic fabric | ● | ● | ● | ● | ● | ● | | | | | | | | |
| 51"H | Monolithic fabric | ● | ● | ● | ● | ● | ● | | | | | | | | |
| 57"H | Monolithic fabric | ● | ● | ● | ● | ● | ● | | | | | | | | |
| 64"H | Monolithic fabric | ● | ● | ● | ● | ● | ● | | | | | | | | |
| 13.5"H | Tackable | ● | ● | ● | ● | ● | ● | | | | | | | | |
| 20.25"H | Tackable | ● | ● | ● | ● | ● | ● | | | | | | | | |
| 6.75"H | Nuform | ● | ● | ● | ● | ● | ● | | | | | | | | |
| 13.5"H | Nuform | ● | ● | ● | ● | ● | ● | | | | | | | | |
| 20.25"H | Nuform | ● | ● | ● | ● | ● | ● | | | | | | | | |
| 27"H | Nuform | ● | ● | ● | ● | ● | ● | | | | | | | | |
| 13.5"H | Whiteboard | ● | ● | ● | ● | ● | ● | ● | ● | ● | ● | ● | ● | ● | ● |
| 20.25"H | Whiteboard | ● | ● | ● | ● | ● | ● | ● | ● | ● | ● | ● | ● | ● | ● |
| 6.75"H | Paper management | ● | ● | ● | ● | ● | ● | ● | ● | ● | ● | ● | ● | ● | ● |
| 13.5"H | Double glazed | | ● | ● | ● | ● | ● | | | | | | | | |
| 6.75"H | Comm - UD - fabric/painted | | ● | ● | ● | ● | ● | ● | ● | | | | | | |
| 13.5"H | Comm - UD - fabric/painted | | ● | ● | ● | ● | ● | ● | ● | | | | | | |
| 20.25"H | Comm - BS - fabric/painted | | ● | ● | ● | ● | ● | ● | ● | | | | | | |
| 6.75"H | Comm - BL - fabric/painted | | ● | ● | ● | ● | ● | ● | ● | | | | | | |
| 13.5"H | Comm - BL - fabric/painted | | ● | ● | ● | ● | ● | ● | ● | | | | | | |
| 6.75"H | Planna m/a - UD -fabric/painted | | | ● | ● | ● | | | | | | | | | |
| 6.75"H | M/A - UD - fabric/painted | | | | ● | ● | ● | ● | ● | | | | | | |
| 13.5"H | M/A - UD - fabric/painted | | | | ● | ● | ● | ● | ● | | | | | | |
| 20.25"H | M/A - BS - fabric/painted | | | | ● | ● | ● | ● | ● | | | | | | |
| 6.75"H | M/A - BL - fabric/painted | | | | ● | ● | ● | ● | ● | | | | | | |
| 13.5"H | M/A - BL - fabric/painted | | | | ● | ● | ● | ● | ● | | | | | | |

**PRODUCT CODE
KEY EXAMPLE**

IN6.75P18

| | |
|-------------|----------------|
| IN | Inscape System |
| 6.75 | 6.75" H |
| P | Painted |
| 18 | 18" W |

- Painted tiles are available in any of Inscape's standard paint colors or a custom color can be accommodated
- Painted tile is magnetic
- Be sure to confirm crossrail locations will accommodate tile height
- Crossrails can be found in the accessory section of the price list under Panel and Table accessories
- Tiles 66"W or wider span two frames. See Application Guide for frame spanning guidelines



| | | Part number | H | W | Neutral paint/ base price | Accent paint |
|---|----------------------|------------------|-------|-------|------------------------------|-----------------|
|  | 6.75" H Painted Tile | IN6.75P18 | 6.75" | 18" | \$58 | +\$9 |
| | | IN6.75P24 | 6.75" | 24" | \$63 | +\$10 |
| | | IN6.75P30 | 6.75" | 30" | \$69 | +\$10 |
| | | IN6.75P36 | 6.75" | 36" | \$71 | +\$10 |
| | | IN6.75P42 | 6.75" | 42" | \$72 | +\$11 |
| | | IN6.75P48 | 6.75" | 48" | \$76 | +\$11 |
| | | IN6.75P54 | 6.75" | 54" | \$79 | +\$11 |
| | | IN6.75P60 | 6.75" | 60" | \$84 | +\$11 |
|  | 13.5" H Painted Tile | IN13.5P18 | 13.5" | 18" | \$59 | +\$9 |
| | | IN13.5P24 | 13.5" | 24" | \$65 | +\$10 |
| | | IN13.5P30 | 13.5" | 30" | \$71 | +\$10 |
| | | IN13.5P36 | 13.5" | 36" | \$72 | +\$11 |
| | | IN13.5P42 | 13.5" | 42" | \$74 | +\$11 |
| | | IN13.5P48 | 13.5" | 48" | \$77 | +\$11 |
| | | IN13.5P54 | 13.5" | 54" | \$81 | +\$11 |
| | | IN13.5P60 | 13.5" | 60" | \$86 | +\$12 |
| | | IN13.5P66 | 13.5" | 66" | \$178 | +\$21 |
| | | IN13.5P72 | 13.5" | 72" | \$184 | +\$21 |
| | | IN13.5P78 | 13.5" | 78" | \$188 | +\$21 |
| | | IN13.5P84 | 13.5" | 84" | \$194 | +\$22 |
| | | IN13.5P90 | 13.5" | 90" | \$197 | +\$22 |
| IN13.5P96 | 13.5" | 96" | \$199 | +\$22 | | |

**PRODUCT CODE
KEY EXAMPLE**

IN6.75P18

| | |
|-------------|----------------|
| IN | Inscape System |
| 6.75 | 6.75" H |
| P | Painted |
| 18 | 18" W |

- Painted tiles are available in any of Inscape's standard paint colors or a custom color can be accommodated
- Painted tile is magnetic
- Be sure to confirm crossrail locations will accommodate tile height
- Crossrails can be found in the accessory section of the price list under Panel and Table accessories
- Tiles 66"W or wider span two frames. See Application Guide for frame spanning guidelines

| | | Part number | H | W | Neutral paint/ base price | Accent paint |
|---|-----------------------|-------------------|--------|-------|------------------------------|-----------------|
|  | 20.25" H Painted Tile | IN20.25P18 | 20.25" | 18" | \$77 | +\$11 |
| | | IN20.25P24 | 20.25" | 24" | \$81 | +\$11 |
| | | IN20.25P30 | 20.25" | 30" | \$86 | +\$12 |
| | | IN20.25P36 | 20.25" | 36" | \$90 | +\$12 |
| | | IN20.25P42 | 20.25" | 42" | \$92 | +\$12 |
| | | IN20.25P48 | 20.25" | 48" | \$94 | +\$12 |
| | | IN20.25P54 | 20.25" | 54" | \$99 | +\$13 |
| | | IN20.25P60 | 20.25" | 60" | \$102 | +\$13 |
| | | IN20.25P66 | 20.25" | 66" | \$208 | +\$23 |
| | | IN20.25P72 | 20.25" | 72" | \$213 | +\$24 |
| | | IN20.25P78 | 20.25" | 78" | \$219 | +\$24 |
| | | IN20.25P84 | 20.25" | 84" | \$223 | +\$25 |
| IN20.25P90 | 20.25" | 90" | \$229 | +\$25 | | |
| IN20.25P96 | 20.25" | 96" | \$234 | +\$25 | | |
|  | 27" H Painted Tile | IN27P18 | 27" | 18" | \$92 | +\$12 |
| | | IN27P24 | 27" | 24" | \$94 | +\$12 |
| | | IN27P30 | 27" | 30" | \$97 | +\$13 |
| | | IN27P36 | 27" | 36" | \$112 | +\$15 |
| | | IN27P42 | 27" | 42" | \$121 | +\$16 |
| | | IN27P48 | 27" | 48" | \$137 | +\$17 |

**PRODUCT CODE
KEY EXAMPLE**

IN6.75F18

| | |
|-------------|----------------|
| IN | Inscape System |
| 6.75 | 6.75" H |
| F | Fabric |
| 18 | 18" W |

- Fabric applied in a railroad orientation as standard
- Fabric tile is magnetic
- Be sure to confirm crossrail locations will accommodate tile height
- Crossrails can be found in the accessory section of the price list under Panel and Table accessories
- Tiles 66" W or wider span two frames. See Application Guide for frame spanning guidelines

NOTES



See finishes section for fabrics that require scrim.

Tile size limitations exist for some fabrics, see finishes section.

In order to get a total cost on products when upcharges are present take the list price of the product number and add the upcharge cost shown to the list price.

For example:

Product IN6.75F18 in Grade 2 with scrim would be \$86 +\$7 +\$15

| | Part number | W | Grade 1/ COM/ Base price | Grade 2 | Grade 3 | Grade 4 | Grade 5 | Grade 6 | Grade 7 | Grade 8 | Scrim |
|--|------------------|-------|--------------------------------|---------|---------|---------|---------|---------|---------|---------|--------|
|  <p>6.75" H Fabric Tile</p> | IN6.75F18 | 18" | \$86 | +\$7 | +\$10 | +\$15 | +\$18 | +\$32 | +\$48 | +\$65 | +\$15 |
| | IN6.75F24 | 24" | \$89 | +\$8 | +\$11 | +\$17 | +\$21 | +\$36 | +\$53 | +\$73 | +\$15 |
| | IN6.75F30 | 30" | \$91 | +\$9 | +\$12 | +\$17 | +\$21 | +\$37 | +\$54 | +\$76 | +\$15 |
| | IN6.75F36 | 36" | \$93 | +\$9 | +\$12 | +\$22 | +\$31 | +\$52 | +\$73 | +\$102 | +\$16 |
| | IN6.75F42 | 42" | \$96 | +\$10 | +\$16 | +\$24 | +\$32 | +\$54 | +\$77 | +\$106 | +\$16 |
| | IN6.75F48 | 48" | \$98 | +\$10 | +\$16 | +\$24 | +\$32 | +\$54 | +\$77 | +\$106 | +\$16 |
| | IN6.75F54 | 54" | \$99 | +\$11 | +\$20 | +\$26 | +\$33 | +\$58 | +\$84 | +\$114 | +\$16 |
| | IN6.75F60 | 60" | \$102 | +\$12 | +\$21 | +\$29 | +\$35 | +\$60 | +\$87 | +\$119 | +\$17 |
|  <p>13.5" H Fabric Tile</p> | IN13.5F18 | 18" | \$98 | +\$7 | +\$22 | +\$24 | +\$31 | +\$46 | +\$61 | +\$87 | +\$16 |
| | IN13.5F24 | 24" | \$101 | +\$7 | +\$24 | +\$27 | +\$34 | +\$45 | +\$60 | +\$86 | +\$16 |
| | IN13.5F30 | 30" | \$105 | +\$8 | +\$26 | +\$33 | +\$37 | +\$45 | +\$61 | +\$87 | +\$17 |
| | IN13.5F36 | 36" | \$110 | +\$12 | +\$26 | +\$35 | +\$45 | +\$67 | +\$92 | +\$128 | +\$17 |
| | IN13.5F42 | 42" | \$116 | +\$15 | +\$27 | +\$36 | +\$47 | +\$72 | +\$98 | +\$135 | +\$18 |
| | IN13.5F48 | 48" | \$120 | +\$15 | +\$27 | +\$36 | +\$47 | +\$72 | +\$99 | +\$137 | +\$18 |
| | IN13.5F54 | 54" | \$124 | +\$16 | +\$29 | +\$42 | +\$52 | +\$81 | +\$106 | +\$147 | +\$20 |
| | IN13.5F60 | 60" | \$129 | +\$16 | +\$29 | +\$42 | +\$52 | +\$81 | +\$106 | +\$147 | +\$20 |
| | IN13.5F66 | 66" | \$239 | +\$17 | +\$29 | +\$42 | +\$52 | +\$83 | +\$107 | +\$151 | +\$93 |
| | IN13.5F72 | 72" | \$243 | +\$17 | +\$18 | +\$25 | +\$33 | +\$66 | +\$99 | +\$137 | +\$94 |
| | IN13.5F78 | 78" | \$245 | +\$17 | +\$20 | +\$27 | +\$35 | +\$71 | +\$105 | +\$146 | +\$94 |
| | IN13.5F84 | 84" | \$255 | +\$18 | +\$20 | +\$27 | +\$35 | +\$71 | +\$105 | +\$146 | +\$96 |
| | IN13.5F90 | 90" | \$256 | +\$18 | +\$21 | +\$31 | +\$42 | +\$77 | +\$112 | +\$157 | +\$118 |
| IN13.5F96 | 96" | \$259 | +\$19 | +\$22 | +\$33 | +\$45 | +\$84 | +\$119 | +\$166 | +\$118 | |

**PRODUCT CODE
KEY EXAMPLE**

IN6.75F18

| | |
|-------------|----------------|
| IN | Inscape System |
| 6.75 | 6.75" H |
| F | Fabric |
| 18 | 18" W |

- Fabric applied in a railroad orientation as standard
- Fabric tile is magnetic
- Be sure to confirm crossrail locations will accommodate tile height
- Crossrails can be found in the accessory section of the price list under Panel and Table accessories
- Tiles 66" W or wider span two frames. See Application Guide for frame spanning guidelines

NOTES



See finishes section for fabrics that require scrim.

Tile size limitations exist for some fabrics, see finishes section.

In order to get a total cost on products when upcharges are present take the list price of the product number and add the upcharge cost shown to the list price.

For example:

Product IN20.25F18 in Grade 2 with scrim would be \$116 +\$7 +\$27

| | Part number | W | Grade 1/ COM/ Base price | Grade 2 | Grade 3 | Grade 4 | Grade 5 | Grade 6 | Grade 7 | Grade 8 | Scrim |
|---|-------------------|-----|--------------------------------|---------|---------|---------|---------|---------|---------|---------|--------|
|  <p>20.25" H Fabric Tile</p> | IN20.25F18 | 18" | \$116 | +\$7 | +\$13 | +\$23 | +\$33 | +\$54 | +\$76 | +\$105 | +\$27 |
| | IN20.25F24 | 24" | \$127 | +\$8 | +\$20 | +\$29 | +\$37 | +\$61 | +\$86 | +\$118 | +\$27 |
| | IN20.25F30 | 30" | \$133 | +\$8 | +\$21 | +\$30 | +\$39 | +\$63 | +\$88 | +\$120 | +\$29 |
| | IN20.25F36 | 36" | \$140 | +\$9 | +\$22 | +\$33 | +\$45 | +\$71 | +\$99 | +\$137 | +\$30 |
| | IN20.25F42 | 42" | \$147 | +\$9 | +\$16 | +\$30 | +\$45 | +\$72 | +\$101 | +\$140 | +\$31 |
| | IN20.25F48 | 48" | \$156 | +\$11 | +\$29 | +\$42 | +\$52 | +\$86 | +\$115 | +\$161 | +\$31 |
| | IN20.25F54 | 54" | \$160 | +\$11 | +\$31 | +\$46 | +\$59 | +\$94 | +\$128 | +\$177 | +\$32 |
| | IN20.25F60 | 60" | \$170 | +\$13 | +\$44 | +\$58 | +\$73 | +\$108 | +\$144 | +\$202 | +\$33 |
| | IN20.25F66 | 66" | \$293 | +\$13 | +\$44 | +\$59 | +\$74 | +\$110 | +\$145 | +\$204 | +\$97 |
| | IN20.25F72 | 72" | \$296 | +\$13 | +\$44 | +\$59 | +\$74 | +\$110 | +\$145 | +\$204 | +\$98 |
| | IN20.25F78 | 78" | \$304 | +\$27 | +\$33 | +\$48 | +\$60 | +\$107 | +\$156 | +\$216 | +\$98 |
| | IN20.25F84 | 84" | \$319 | +\$30 | +\$34 | +\$50 | +\$65 | +\$114 | +\$164 | +\$226 | +\$121 |
| | IN20.25F90 | 90" | \$322 | +\$31 | +\$37 | +\$54 | +\$70 | +\$121 | +\$172 | +\$240 | +\$121 |
| | IN20.25F96 | 96" | \$326 | +\$32 | +\$39 | +\$58 | +\$76 | +\$130 | +\$182 | +\$253 | +\$124 |
|  <p>27" H Fabric Tile</p> | IN27F18 | 18" | \$134 | +\$7 | +\$15 | +\$25 | +\$35 | +\$63 | +\$90 | +\$125 | +\$27 |
| | IN27F24 | 24" | \$139 | +\$8 | +\$15 | +\$26 | +\$39 | +\$67 | +\$97 | +\$134 | +\$29 |
| | IN27F30 | 30" | \$147 | +\$9 | +\$16 | +\$29 | +\$44 | +\$73 | +\$104 | +\$144 | +\$30 |
| | IN27F36 | 36" | \$157 | +\$10 | +\$22 | +\$35 | +\$49 | +\$86 | +\$119 | +\$166 | +\$31 |
| | IN27F42 | 42" | \$171 | +\$11 | +\$24 | +\$37 | +\$51 | +\$88 | +\$125 | +\$171 | +\$32 |
| | IN27F48 | 48" | \$174 | +\$12 | +\$26 | +\$42 | +\$54 | +\$94 | +\$133 | +\$185 | +\$33 |

Architecture

Tiles
Tackable

System

PRODUCT CODE KEY EXAMPLE

IN13.5TK18

| | |
|-------------|----------------|
| IN | Inscape System |
| 13.5 | 13.5" H |
| TK | Tackable |
| 18 | 18" W |

- Fabric applied in a railroad orientation as standard
- Fabric tile is magnetic
- NRC 0.55, STC 9
- Wall Mount Tile Kit must match height of tile
- It is recommended that tackable tiles are not to be used on the outside of a workstation
- Be sure to confirm crossrail locations will accommodate tile height
- Crossrails can be found in the accessory section of the price list under Panel and Table accessories

NOTES



See finishes section for fabrics that require scrim.

Tile size limitations exist for some fabrics, see finishes section.

In order to get a total cost on products when upcharges are present take the list price of the product number and add the upcharge cost shown to the list price.

For example:

Product IN13.5TK18 in Grade 2 with scrim would be \$145 +\$7 +\$25

| | Part number | W | Grade 1/ COM/ Base price | Grade 2 | Grade 3 | Grade 4 | Grade 5 | Grade 6 | Grade 7 | Grade 8 | Scrim |
|---|--------------------|-----|--------------------------------|---------|---------|---------|---------|---------|---------|---------|-------|
|  13.5" H Tackable Tile | IN13.5TK18 | 18" | \$145 | +\$7 | +\$11 | +\$20 | +\$29 | +\$51 | +\$73 | +\$102 | +\$25 |
| | IN13.5TK24 | 24" | \$151 | +\$8 | +\$12 | +\$21 | +\$29 | +\$52 | +\$74 | +\$103 | +\$27 |
| | IN13.5TK30 | 30" | \$156 | +\$9 | +\$12 | +\$21 | +\$29 | +\$53 | +\$77 | +\$106 | +\$29 |
| | IN13.5TK36 | 36" | \$160 | +\$12 | +\$22 | +\$32 | +\$44 | +\$73 | +\$103 | +\$143 | +\$30 |
| | IN13.5TK42 | 42" | \$165 | +\$13 | +\$23 | +\$33 | +\$45 | +\$76 | +\$106 | +\$147 | +\$32 |
| | IN13.5TK48 | 48" | \$187 | +\$13 | +\$23 | +\$35 | +\$48 | +\$84 | +\$115 | +\$161 | +\$33 |
|  20.25" H Tackable Tile | IN20.25TK18 | 18" | \$216 | +\$6 | +\$13 | +\$22 | +\$31 | +\$56 | +\$83 | +\$111 | +\$27 |
| | IN20.25TK24 | 24" | \$220 | +\$8 | +\$15 | +\$25 | +\$36 | +\$64 | +\$92 | +\$128 | +\$30 |
| | IN20.25TK30 | 30" | \$223 | +\$9 | +\$15 | +\$26 | +\$39 | +\$76 | +\$112 | +\$157 | +\$32 |
| | IN20.25TK36 | 36" | \$228 | +\$10 | +\$22 | +\$33 | +\$46 | +\$81 | +\$114 | +\$160 | +\$34 |
| | IN20.25TK42 | 42" | \$233 | +\$10 | +\$16 | +\$27 | +\$39 | +\$73 | +\$106 | +\$147 | +\$36 |
| | IN20.25TK48 | 48" | \$238 | +\$12 | +\$22 | +\$36 | +\$51 | +\$88 | +\$121 | +\$169 | +\$39 |
|  33.75" H Tackable Tile | IN33.75TK18 | 18" | \$324 | +\$15 | +\$22 | +\$30 | +\$37 | +\$73 | +\$108 | +\$152 | +\$32 |
| | IN33.75TK24 | 24" | \$342 | +\$16 | +\$22 | +\$30 | +\$37 | +\$76 | +\$112 | +\$157 | +\$35 |
| | IN33.75TK30 | 30" | \$360 | +\$16 | +\$26 | +\$31 | +\$39 | +\$79 | +\$118 | +\$165 | +\$42 |
| | IN33.75TK36 | 36" | \$380 | +\$30 | +\$34 | +\$51 | +\$66 | +\$119 | +\$170 | +\$237 | +\$45 |
| | IN33.75TK42 | 42" | \$399 | +\$30 | +\$35 | +\$51 | +\$66 | +\$121 | +\$174 | +\$245 | +\$48 |
| | IN33.75TK48 | 48" | \$416 | +\$31 | +\$36 | +\$53 | +\$69 | +\$127 | +\$182 | +\$253 | +\$52 |



| | Part number | Neutral paint/ base price | Accent paint |
|---|---------------|------------------------------|-----------------|
|  Wall Mount Tackable Tile Kits | WMTL13 | \$60 | +\$9 |
| | WMTL20 | \$63 | +\$10 |

**PRODUCT CODE
KEY EXAMPLE**

IN6.75NF18

| | |
|-------------|----------------|
| IN | Inscape System |
| 6.75 | 6.75" H |
| NF | Nuform |
| 18 | 18" W |

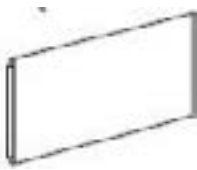
- Stiffener bar prevents installation of this tile in any location where power track is installed in a 2 ¾" frame. See Inscape System Application Guide
- Some tile configurations require crossrails to be cut and additional crossrails ordered separately, See Inscape System Application Guide
- Be sure to confirm crossrail locations will accommodate tile height
- Crossrails can be found in the accessory section of the price list under Panel and Table accessories
- Due to limitations in the foil size, 48" and wider tiles are not available in F06 Walnut
- Direction of woodgrain is vertical

| | | Part number | H | W | Nuform classic/ base price | Nuform select |
|---|----------------------|--------------------|--------|-----|-------------------------------|---------------|
|  | 6.75" H Nuform Tile | IN6.75NF18 | 6.75" | 18" | \$235 | +\$27 |
| | | IN6.75NF24 | 6.75" | 24" | \$243 | +\$27 |
| | | IN6.75NF30 | 6.75" | 30" | \$250 | +\$29 |
| | | IN6.75NF36 | 6.75" | 36" | \$255 | +\$30 |
| | | IN6.75NF42 | 6.75" | 42" | \$262 | +\$30 |
| | | IN6.75NF48 | 6.75" | 48" | \$268 | +\$31 |
|  | 13.5" H Nuform Tile | IN13.5NF18 | 13.5" | 18" | \$247 | +\$29 |
| | | IN13.5NF24 | 13.5" | 24" | \$253 | +\$29 |
| | | IN13.5NF30 | 13.5" | 30" | \$263 | +\$30 |
| | | IN13.5NF36 | 13.5" | 36" | \$274 | +\$31 |
| | | IN13.5NF42 | 13.5" | 42" | \$286 | +\$33 |
| | | IN13.5NF48 | 13.5" | 48" | \$293 | +\$33 |
|  | 20.25" H Nuform Tile | IN20.25NF18 | 20.25" | 18" | \$283 | +\$32 |
| | | IN20.25NF24 | 20.25" | 24" | \$294 | +\$34 |
| | | IN20.25NF30 | 20.25" | 30" | \$316 | +\$36 |
| | | IN20.25NF36 | 20.25" | 36" | \$331 | +\$37 |
| | | IN20.25NF42 | 20.25" | 42" | \$344 | +\$39 |
| | | IN20.25NF48 | 20.25" | 48" | \$358 | +\$42 |
|  | 27" H Nuform Tile | IN27NF18 | 27" | 18" | \$293 | +\$33 |
| | | IN27NF24 | 27" | 24" | \$310 | +\$35 |
| | | IN27NF30 | 27" | 30" | \$329 | +\$37 |
| | | IN27NF36 | 27" | 36" | \$345 | +\$39 |
| | | IN27NF42 | 27" | 42" | \$362 | +\$42 |
| | | IN27NF48 | 27" | 48" | \$380 | +\$44 |

**PRODUCT CODE
KEY EXAMPLE**

IN13.5NFPHE18

| | |
|-------------|-----------------------|
| IN | Inscape System |
| 13.5 | 13.5" H |
| NFP | Nuform patterned tile |
| HE | Herringbone |
| 18 | 18" W |





- Only available for use on 37", 44" and 51" H frames
- Patterned tiles must be applied in specific configurations based on the height of the frame in order for the pattern to line up correctly
- Due to limitations in the foil size, 48" and wider tiles are not available in F06 Walnut
- Direction of woodgrain is horizontal

NOTES

Patterned tiles cannot be used with the following as they will interfere with the installation:

- Off-module brackets
- Power poles
- Worksurfaces front edge support brackets
- Up-mount bins
- Transaction Tops
- Electrical covers
- Dekko power tracks for 2 3/4" frames

Can only be used on the outside face of a workstation



| | | Part number | H | W | Nuform classic/ 2 3/4" thick frame/ Base price | 3 1/2" thick frame | Nuform select |
|---|--|------------------------|--------|-----|--|--------------------|---------------|
|  | 13.5" H Nuform Patterned Tile, Herringbone for top location only | IN13.5NFPHE72 | 13.5" | 72" | \$602 | +\$22 | +\$67 |
| | | IN13.5NFPHE84 | 13.5" | 84" | \$625 | +\$47 | +\$70 |
| | | IN13.5NFPHE96 | 13.5" | 96" | \$654 | +\$51 | +\$73 |
|  | 20.25" H Nuform Patterned Tile, Herringbone for top location only | IN20.25NFPHE72 | 20.25" | 72" | \$667 | +\$23 | +\$74 |
| | | IN20.25NFPHE84 | 20.25" | 84" | \$699 | +\$48 | +\$79 |
| | | IN20.25NFPHE96 | 20.25" | 96" | \$741 | +\$51 | +\$84 |
|  | 20.25" H Nuform Patterned Tile, Herringbone for bottom location only | IN20.25NFPHEB72 | 20.25" | 72" | \$667 | +\$23 | +\$74 |
| | | IN20.25NFPHEB84 | 20.25" | 84" | \$699 | +\$48 | +\$79 |
| | | IN20.25NFPHEB96 | 20.25" | 96" | \$741 | +\$51 | +\$84 |
|  | 27" H Nuform Patterned Tile, Herringbone for bottom location only | IN27NFPHEB72 | 27" | 72" | \$845 | +\$31 | +\$94 |
| | | IN27NFPHEB84 | 27" | 84" | \$888 | +\$69 | +\$99 |
| | | IN27NFPHEB96 | 27" | 96" | \$944 | +\$76 | +\$105 |

**PRODUCT CODE
KEY EXAMPLE**

IN13.5WB18

| | |
|-------------|----------------|
| IN | Inscape System |
| 13.5 | 13.5" H |
| WB | Whiteboard |
| 18 | 18" W |

- Only Expo Markers are to be used on any Inscape Whiteboard. Whiteboards should be cleaned with Expo Eraser or a Microfiber cleaning cloth along with Expo Cleaning Solution which is formulated to remove residue from Expo Dry Erase Markers
 - Be sure to confirm crossrail locations will accommodate tile height
 - Wall Mount Tile Kit must match height of tile
 - Tiles 66" W or wider span two frames.
- *See Application Guide for frame spanning guidelines*

| | Part number | H | W | List price |
|---|-------------------------------|--------|-------|------------|
|  | 13.5" H Whiteboard Tile | | | |
| | IN13.5WB18 | 13.5" | 18" | \$96 |
| | IN13.5WB24 | 13.5" | 24" | \$100 |
| | IN13.5WB30 | 13.5" | 30" | \$103 |
| | IN13.5WB36 | 13.5" | 36" | \$105 |
| | IN13.5WB42 | 13.5" | 42" | \$107 |
| | IN13.5WB48 | 13.5" | 48" | \$114 |
| | IN13.5WB54 | 13.5" | 54" | \$127 |
| | IN13.5WB60 | 13.5" | 60" | \$132 |
| | IN13.5WB66 | 13.5" | 66" | \$227 |
| | IN13.5WB72 | 13.5" | 72" | \$234 |
| | IN13.5WB78 | 13.5" | 78" | \$245 |
| | IN13.5WB84 | 13.5" | 84" | \$250 |
| IN13.5WB90 | 13.5" | 90" | \$255 | |
| IN13.5WB96 | 13.5" | 96" | \$262 | |
|  | 20.25" H Whiteboard Tile | | | |
| | IN20.25WB18 | 20.25" | 18" | \$104 |
| | IN20.25WB24 | 20.25" | 24" | \$110 |
| | IN20.25WB30 | 20.25" | 30" | \$115 |
| | IN20.25WB36 | 20.25" | 36" | \$120 |
| | IN20.25WB42 | 20.25" | 42" | \$127 |
| | IN20.25WB48 | 20.25" | 48" | \$131 |
| | IN20.25WB54 | 20.25" | 54" | \$153 |
| | IN20.25WB60 | 20.25" | 60" | \$159 |
| | IN20.25WB66 | 20.25" | 66" | \$240 |
| | IN20.25WB72 | 20.25" | 72" | \$248 |
| | IN20.25WB78 | 20.25" | 78" | \$255 |
| | IN20.25WB84 | 20.25" | 84" | \$264 |
| IN20.25WB90 | 20.25" | 90" | \$273 | |
| IN20.25WB96 | 20.25" | 96" | \$281 | |
|  | Wall Mount Tackable Tile Kits | | | |
| | WMTL13 | 13.5" | — | \$60 |
| | WMTL20 | 20.25" | — | \$63 |



**PRODUCT CODE
 KEY EXAMPLE**

| | |
|---------------|--------------------------------|
| IN6.75PM18-3F | |
| IN | Inscape System |
| 6.75 | 6.75" H |
| PM | Paper Management |
| 18 | 18" W |
| 3F | 3 1/2" thick frame application |

- "2F" denotes use with 2 3/4" thick frame, "3F" denotes use with 3 1/2" thick frame
- Be sure to confirm crossrail locations will accommodate tile configuration
- Paper management tiles are not to be installed below the work surface
- Tiles 66" W or wider span two frames. See Application Guide for frame spanning guidelines

NOTES

54" and 60" W Paper Management tiles include reinforcing brackets

| | | Part number | H | W | Neutral paint/ base price | Accent paint |
|---|--|----------------------|-------|-----|------------------------------|-----------------|
|  | 6.75" H Paper Management Tile for use with 3 1/2" T frames | IN6.75PM18-3F | 6.75" | 18" | \$126 | +\$16 |
| | | IN6.75PM24-3F | 6.75" | 24" | \$140 | +\$17 |
| | | IN6.75PM30-3F | 6.75" | 30" | \$160 | +\$19 |
| | | IN6.75PM36-3F | 6.75" | 36" | \$174 | +\$20 |
| | | IN6.75PM42-3F | 6.75" | 42" | \$195 | +\$22 |
| | | IN6.75PM48-3F | 6.75" | 48" | \$211 | +\$23 |
| | | IN6.75PM54-3F | 6.75" | 54" | \$227 | +\$25 |
| | | IN6.75PM60-3F | 6.75" | 60" | \$249 | +\$27 |
| | | IN6.75PM66-3F | 6.75" | 66" | \$336 | +\$35 |
| | | IN6.75PM72-3F | 6.75" | 72" | \$348 | +\$36 |
| | | IN6.75PM78-3F | 6.75" | 78" | \$358 | +\$37 |
| | | IN6.75PM84-3F | 6.75" | 84" | \$410 | +\$44 |
| | | IN6.75PM90-3F | 6.75" | 90" | \$424 | +\$46 |
| | | IN6.75PM96-3F | 6.75" | 96" | \$436 | +\$47 |
|  | 6.75" H Paper Management Tile for use with 2 3/4" T frames | IN6.75PM18-2F | 6.75" | 18" | \$126 | +\$16 |
| | | IN6.75PM24-2F | 6.75" | 24" | \$140 | +\$17 |
| | | IN6.75PM30-2F | 6.75" | 30" | \$160 | +\$19 |
| | | IN6.75PM36-2F | 6.75" | 36" | \$174 | +\$20 |
| | | IN6.75PM42-2F | 6.75" | 42" | \$195 | +\$22 |
| | | IN6.75PM48-2F | 6.75" | 48" | \$211 | +\$23 |
| | | IN6.75PM54-2F | 6.75" | 54" | \$227 | +\$25 |
| | | IN6.75PM60-2F | 6.75" | 60" | \$249 | +\$27 |
| | | IN6.75PM66-2F | 6.75" | 66" | \$328 | +\$34 |
| | | IN6.75PM72-2F | 6.75" | 72" | \$341 | +\$36 |
| | | IN6.75PM78-2F | 6.75" | 78" | \$353 | +\$37 |
| | | IN6.75PM84-2F | 6.75" | 84" | \$401 | +\$44 |
| | | IN6.75PM90-2F | 6.75" | 90" | \$414 | +\$45 |
| | | IN6.75PM96-2F | 6.75" | 96" | \$429 | +\$46 |

Architecture

Tiles

Paper Management Tile Reinforcing Kit

System

PRODUCT CODE
KEY EXAMPLE

INPMRK-3F



IN Inscape System

PM Paper Management

RK Reinforcement Kit

3F 3 1/2" thick frame

- “2F” denotes use with 2.75" thick frame, “3F” denotes use with 3.5" thick frame
- When specifying monitor arms to mount on paper management tile, reinforcing bracket must be specified (frame thickness specific)
- Reinforcement Kit includes reinforcing brackets for Paper Management Tile



| | | Part number | H | W | List price |
|--|---|------------------|---|-----|------------|
|  | Paper Management Reinforcing Kit for use with 3 1/2" T frames | INPMRK-3F | — | 18" | \$126 |
|  | Paper Management Reinforcing Kit for use with 2 3/4" T frames | INPMRK-2F | — | 18" | \$126 |

**PRODUCT CODE
KEY EXAMPLE**

IN13.5PF18

| | |
|-------------|----------------|
| IN | Inscape System |
| 13.5 | 13.5" H |
| PF | Perforated |
| 18 | 18" W |

- Perforated tiles are available in any of Inscape's standard paint colors or a custom color can be accommodated
- Painted tile is magnetic
- Be sure to confirm crossrail locations will accommodate tile height
- Crossrails can be found in the accessory section of the price list under Panel and Table accessories

| | | Part number | H | W | Neutral paint/ base price | Accent paint |
|---|--------------------------|--------------------|--------|-----|------------------------------|-----------------|
|  | 13.5" H Perforated Tile | IN13.5PF18 | 13.5" | 18" | \$74 | +\$11 |
| | | IN13.5PF24 | 13.5" | 24" | \$77 | +\$11 |
| | | IN13.5PF30 | 13.5" | 30" | \$86 | +\$12 |
| | | IN13.5PF36 | 13.5" | 36" | \$87 | +\$12 |
| | | IN13.5PF42 | 13.5" | 42" | \$88 | +\$12 |
| | | IN13.5PF48 | 13.5" | 48" | \$91 | +\$12 |
| | | IN13.5PF54 | 13.5" | 54" | \$92 | +\$12 |
| | | IN13.5PF60 | 13.5" | 60" | \$94 | +\$12 |
|  | 20.25" H Perforated Tile | IN20.25PF18 | 20.25" | 18" | \$90 | +\$12 |
| | | IN20.25PF24 | 20.25" | 24" | \$92 | +\$12 |
| | | IN20.25PF30 | 20.25" | 30" | \$94 | +\$12 |
| | | IN20.25PF36 | 20.25" | 36" | \$100 | +\$13 |
| | | IN20.25PF42 | 20.25" | 42" | \$103 | +\$13 |
| | | IN20.25PF48 | 20.25" | 48" | \$107 | +\$15 |
| | | IN20.25PF54 | 20.25" | 54" | \$112 | +\$15 |
| | | IN20.25PF60 | 20.25" | 60" | \$116 | +\$15 |
|  | 27" H Perforated Tile | IN27PF18 | 27" | 18" | \$102 | +\$13 |
| | | IN27PF24 | 27" | 24" | \$104 | +\$13 |
| | | IN27PF30 | 27" | 30" | \$106 | +\$13 |
| | | IN27PF36 | 27" | 36" | \$108 | +\$15 |
| | | IN27PF42 | 27" | 42" | \$119 | +\$15 |
| | | IN27PF48 | 27" | 48" | \$127 | +\$16 |

Architecture

Tiles

Communication - Painted

System

PRODUCT CODE KEY EXAMPLE

IN6.75CTP24-UD

| | |
|-------------|----------------------------|
| IN | Inscape System |
| 6.75 | 6.75" H |
| CTP | Painted Communication Tile |
| 24 | 24" W |
| UD | Upper deck location |

- Painted tiles are available in any of Inscape's standard paint colors or a custom color can be accommodated
- Painted tile is magnetic
- Specific locations where these tiles may be installed on frame; *See *Inscape System Application Guide*
- Flush bezel color option of black, white and gray (default black)
- Be sure to confirm crossrail locations will accommodate tile height
- Crossrails are required with the 6.75"h bottom location tiles
- Crossrails can be found in the accessory section of the price list under Panel and Table accessories





NOTES

Code suffix denote specific tile location:

UD = Upper deck

BL = Beltline

BS = Base

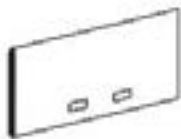
| | | Part number | H | W | Neutral paint/ base price | Accent paint |
|---|--|------------------------|--------|-----|------------------------------|-----------------|
|  | 6.75" H Painted Communication Tile Upper Deck Location | IN6.75CTP24-UD | 6.75" | 24" | \$71 | +\$10 |
| | | IN6.75CTP30-UD | 6.75" | 30" | \$74 | +\$11 |
| | | IN6.75CTP36-UD | 6.75" | 36" | \$76 | +\$11 |
| | | IN6.75CTP42-UD | 6.75" | 42" | \$79 | +\$11 |
| | | IN6.75CTP48-UD | 6.75" | 48" | \$81 | +\$11 |
| | | IN6.75CTP54-UD | 6.75" | 54" | \$87 | +\$12 |
| | | IN6.75CTP60-UD | 6.75" | 60" | \$90 | +\$12 |
|  | 13.5" H Painted Communication Tile Upper Deck Location | IN13.5CTP24-UD | 13.5" | 24" | \$99 | +\$13 |
| | | IN13.5CTP30-UD | 13.5" | 30" | \$102 | +\$13 |
| | | IN13.5CTP36-UD | 13.5" | 36" | \$107 | +\$15 |
| | | IN13.5CTP42-UD | 13.5" | 42" | \$112 | +\$15 |
| | | IN13.5CTP48-UD | 13.5" | 48" | \$119 | +\$15 |
| | | IN13.5CTP54-UD | 13.5" | 54" | \$120 | +\$16 |
| | | IN13.5CTP60-UD | 13.5" | 60" | \$124 | +\$16 |
|  | 6.75" H Painted Communication Tile Beltline Location | IN6.75CTP24-BL | 6.75" | 24" | \$71 | +\$10 |
| | | IN6.75CTP30-BL | 6.75" | 30" | \$74 | +\$11 |
| | | IN6.75CTP36-BL | 6.75" | 36" | \$76 | +\$11 |
| | | IN6.75CTP42-BL | 6.75" | 42" | \$79 | +\$11 |
| | | IN6.75CTP48-BL | 6.75" | 48" | \$81 | +\$11 |
| | | IN6.75CTP54-BL | 6.75" | 54" | \$87 | +\$12 |
| | | IN6.75CTP60-BL | 6.75" | 60" | \$90 | +\$12 |
|  | 13.5" H Painted Communication Tile Beltline Location | IN13.5CTP24-BL | 13.5" | 24" | \$99 | +\$13 |
| | | IN13.5CTP30-BL | 13.5" | 30" | \$102 | +\$13 |
| | | IN13.5CTP36-BL | 13.5" | 36" | \$107 | +\$15 |
| | | IN13.5CTP42-BL | 13.5" | 42" | \$112 | +\$15 |
| | | IN13.5CTP48-BL | 13.5" | 48" | \$119 | +\$15 |
| | | IN13.5CTP54-BL | 13.5" | 54" | \$120 | +\$16 |
| | | IN13.5CTP60-BL | 13.5" | 60" | \$124 | +\$16 |
|  | 6.75" H Painted Communication Tile Bottom Location | IN6.75CTP30-BS | 6.75" | 30" | \$91 | +\$9 |
| | | IN6.75CTP36-BS | 6.75" | 36" | \$98 | +\$9 |
| | | IN6.75CTP42-BS | 6.75" | 42" | \$103 | +\$10 |
| | | IN6.75CTP48-BS | 6.75" | 48" | \$114 | +\$11 |
|  | 20.25" H Painted Communication Tile Bottom Location | IN20.25CTP24-BS | 20.25" | 24" | \$124 | +\$16 |
| | | IN20.25CTP30-BS | 20.25" | 30" | \$128 | +\$16 |
| | | IN20.25CTP36-BS | 20.25" | 36" | \$135 | +\$17 |
| | | IN20.25CTP42-BS | 20.25" | 42" | \$144 | +\$18 |
| | | IN20.25CTP48-BS | 20.25" | 48" | \$151 | +\$18 |
| | | IN20.25CTP54-BS | 20.25" | 54" | \$169 | +\$20 |
| | | IN20.25CTP60-BS | 20.25" | 60" | \$172 | +\$20 |

Architecture

Tiles

Communication - Fabric

System

PRODUCT CODE KEY EXAMPLE

IN6.75CTF24-UD

| | |
|-------------|------------------------------|
| IN | Inscape System |
| 6.75 | 6.75" H |
| CTF | Fabric Communication Tile |
| 24 | 24" W |
| UD | Upper deck location |

- Fabric applied in a railroad orientation as standard
- Fabric tile is magnetic.
- Specific locations where these tiles may be installed on frame; *See *Inscape System Application Guide*
- Flush bezel color option of black, white and gray (default black)
- Be sure to confirm crossrail locations will accommodate tile height
- Crossrails can be found in the accessory section of the price list under Panel and Table accessories

NOTES

Code suffix denote specific tile location:

UD = Upper deck

BL = Beltline

BS = Base





See finishes section for fabrics that requires scrim.

Tile size limitations exist for some fabrics, see finishes section.

In order to get a total cost on products when upcharges are present take the list price of the product number and add the upcharge cost shown to the list price.

For example:

Product IN6.75CTF24-UD in Grade 2 with scrim would be \$91 +\$7 +\$15

| | Part number | W | Grade 1/ COM/ Base price | Grade 2 | Grade 3 | Grade 4 | Grade 5 | Grade 6 | Grade 7 | Grade 8 | Scrim |
|--|-----------------------|-----|--------------------------------|---------|---------|---------|---------|---------|---------|---------|-------|
|  6.75" H Fabric Communication Tile Upper Deck Location | IN6.75CTF24-UD | 24" | \$91 | +\$7 | +\$9 | +\$13 | +\$18 | +\$35 | +\$53 | +\$73 | +\$15 |
| | IN6.75CTF30-UD | 30" | \$93 | +\$7 | +\$9 | +\$13 | +\$18 | +\$35 | +\$53 | +\$73 | +\$15 |
| | IN6.75CTF36-UD | 36" | \$105 | +\$9 | +\$12 | +\$21 | +\$30 | +\$52 | +\$74 | +\$103 | +\$16 |
| | IN6.75CTF42-UD | 42" | \$110 | +\$10 | +\$11 | +\$20 | +\$27 | +\$50 | +\$72 | +\$101 | +\$16 |
| | IN6.75CTF48-UD | 48" | \$114 | +\$10 | +\$13 | +\$22 | +\$30 | +\$53 | +\$77 | +\$106 | +\$16 |
| | IN6.75CTF54-UD | 54" | \$120 | +\$11 | +\$13 | +\$22 | +\$30 | +\$54 | +\$79 | +\$108 | +\$16 |
| | IN6.75CTF60-UD | 60" | \$131 | +\$11 | +\$13 | +\$24 | +\$34 | +\$63 | +\$91 | +\$127 | +\$17 |
|  13.5" H Fabric Communication Tile Upper Deck Location | IN13.5CTF24-UD | 24" | \$114 | +\$9 | +\$15 | +\$23 | +\$31 | +\$54 | +\$79 | +\$108 | +\$16 |
| | IN13.5CTF30-UD | 30" | \$119 | +\$8 | +\$12 | +\$21 | +\$29 | +\$53 | +\$77 | +\$106 | +\$17 |
| | IN13.5CTF36-UD | 36" | \$131 | +\$9 | +\$16 | +\$27 | +\$39 | +\$69 | +\$98 | +\$135 | +\$17 |
| | IN13.5CTF42-UD | 42" | \$134 | +\$10 | +\$20 | +\$29 | +\$37 | +\$71 | +\$100 | +\$140 | +\$18 |
| | IN13.5CTF48-UD | 48" | \$139 | +\$12 | +\$25 | +\$35 | +\$46 | +\$76 | +\$106 | +\$147 | +\$18 |
| | IN13.5CTF54-UD | 54" | \$140 | +\$13 | +\$27 | +\$39 | +\$50 | +\$84 | +\$114 | +\$160 | +\$20 |
| | IN13.5CTF60-UD | 60" | \$153 | +\$15 | +\$16 | +\$27 | +\$42 | +\$73 | +\$105 | +\$146 | +\$20 |
|  6.75" H Fabric Communication Tile Beltline Location | IN6.75CTF24-BL | 24" | \$91 | +\$7 | +\$9 | +\$13 | +\$18 | +\$35 | +\$53 | +\$73 | +\$15 |
| | IN6.75CTF30-BL | 30" | \$93 | +\$7 | +\$9 | +\$13 | +\$18 | +\$35 | +\$53 | +\$73 | +\$15 |
| | IN6.75CTF36-BL | 36" | \$105 | +\$9 | +\$10 | +\$21 | +\$25 | +\$52 | +\$74 | +\$103 | +\$16 |
| | IN6.75CTF42-BL | 42" | \$110 | +\$10 | +\$11 | +\$21 | +\$27 | +\$50 | +\$72 | +\$101 | +\$16 |
| | IN6.75CTF48-BL | 48" | \$114 | +\$10 | +\$12 | +\$22 | +\$30 | +\$53 | +\$77 | +\$106 | +\$16 |
| | IN6.75CTF54-BL | 54" | \$120 | +\$11 | +\$13 | +\$22 | +\$30 | +\$54 | +\$79 | +\$108 | +\$16 |
| | IN6.75CTF60-BL | 60" | \$131 | +\$11 | +\$13 | +\$24 | +\$34 | +\$63 | +\$91 | +\$127 | +\$17 |
|  13.5" H Fabric Communication Tile Beltline Location | IN13.5CTF24-BL | 24" | \$114 | +\$8 | +\$15 | +\$23 | +\$31 | +\$54 | +\$79 | +\$108 | +\$16 |
| | IN13.5CTF30-BL | 30" | \$119 | +\$9 | +\$15 | +\$25 | +\$34 | +\$53 | +\$77 | +\$106 | +\$17 |
| | IN13.5CTF36-BL | 36" | \$131 | +\$9 | +\$16 | +\$27 | +\$39 | +\$69 | +\$98 | +\$135 | +\$17 |
| | IN13.5CTF42-BL | 42" | \$134 | +\$10 | +\$20 | +\$29 | +\$43 | +\$71 | +\$100 | +\$143 | +\$18 |
| | IN13.5CTF48-BL | 48" | \$139 | +\$12 | +\$25 | +\$35 | +\$46 | +\$76 | +\$106 | +\$147 | +\$18 |
| | IN13.5CTF54-BL | 54" | \$140 | +\$13 | +\$27 | +\$39 | +\$50 | +\$84 | +\$114 | +\$160 | +\$20 |
| | IN13.5CTF60-BL | 60" | \$153 | +\$15 | +\$27 | +\$42 | +\$52 | +\$86 | +\$116 | +\$162 | +\$20 |

Architecture

Tiles

Communication - Fabric

System

IN6.75CTF24-UD

| | |
|-------------|---------------------------|
| IN | Inscape System |
| 6.75 | 6.75" H |
| CTF | Fabric Communication Tile |
| 24 | 24" W |
| UD | Upper deck location |

- Fabric applied in a railroad orientation as standard
- Fabric tile is magnetic.
- Specific locations where these tiles may be installed on frame; *See *Inscape System Application Guide*
- Flush bezel color option of black, white and gray (default black)
- Be sure to confirm crossrail locations will accommodate tile height
- Crossrails can be found in the accessory section of the price list under Panel and Table accessories

NOTES

Code suffix denote specific tile location:

UD = Upper deck

BL = Beltline

BS = Base

See finishes section for fabrics that requires scrim.

Tile size limitations exist for some fabrics, see finishes section.

In order to get a total cost on products when upcharges are present take the list price of the product number and add the upcharge cost shown to the list price.

For example:

Product IN20.25CTF24-BS in Grade 2 with scrim would be \$137 +\$8 +\$27

| Part number | W | Grade 1/ COM/ Base price | Grade 2 | Grade 3 | Grade 4 | Grade 5 | Grade 6 | Grade 7 | Grade 8 | Scrim |
|------------------------|-----|--------------------------------|---------|---------|---------|---------|---------|---------|---------|-------|
| IN20.25CTF24-BS | 24" | \$137 | +\$8 | +\$21 | +\$31 | +\$42 | +\$71 | +\$101 | +\$140 | +\$27 |
| IN20.25CTF30-BS | 30" | \$139 | +\$7 | +\$22 | +\$32 | +\$44 | +\$73 | +\$103 | +\$143 | +\$29 |
| IN20.25CTF36-BS | 36" | \$162 | +\$9 | +\$22 | +\$34 | +\$48 | +\$85 | +\$119 | +\$166 | +\$30 |
| IN20.25CTF42-BS | 42" | \$167 | +\$10 | +\$25 | +\$37 | +\$51 | +\$88 | +\$126 | +\$174 | +\$31 |
| IN20.25CTF48-BS | 48" | \$171 | +\$12 | +\$29 | +\$44 | +\$56 | +\$96 | +\$133 | +\$185 | +\$31 |
| IN20.25CTF54-BS | 54" | \$174 | +\$12 | +\$31 | +\$47 | +\$61 | +\$103 | +\$143 | +\$201 | +\$32 |
| IN20.25CTF60-BS | 60" | \$179 | +\$13 | +\$42 | +\$58 | +\$74 | +\$119 | +\$162 | +\$225 | +\$33 |



20.25" H Fabric Communication Tile Bottom Location

Architecture

Tiles
Multi Access - Painted

System

PRODUCT CODE KEY EXAMPLE

| | |
|----------------|---------------------------|
| IN6.75MAP30-UD | |
| IN | Inscape System |
| 6.75 | 6.75" H |
| MAP | Painted Multi Access Tile |
| 30 | 30" W |
| UD | Upper deck location |

- Painted tiles are available in any of Inscape's standard paint colors or a custom color can be accommodated
- Painted tile is magnetic
- Specific locations where these tiles may be installed on frame; *See *Inscape System Application Guide*
- Flush bezel color option of black (default), white and gray
- Be sure to confirm crossrail locations will accommodate tile height
- Crossrails can be found in the accessory section of the price list under Panel and Table accessories





NOTES

Code suffix denote specific tile location:

UD = Upper deck

BL = Beltline

BS = Base

| | | Part number | H | W | Neutral paint/ base price | Accent paint |
|---|--|------------------------|--------|-----|------------------------------|-----------------|
|  | 6.75" H Painted Multi Access Tile Upper Deck Location | IN6.75MAP30-UD | 6.75" | 30" | \$74 | +\$11 |
| | | IN6.75MAP36-UD | 6.75" | 36" | \$76 | +\$11 |
| | | IN6.75MAP42-UD | 6.75" | 42" | \$79 | +\$11 |
| | | IN6.75MAP48-UD | 6.75" | 48" | \$81 | +\$11 |
| | | IN6.75MAP54-UD | 6.75" | 54" | \$87 | +\$12 |
| | | IN6.75MAP60-UD | 6.75" | 60" | \$90 | +\$12 |
|  | 13.5" H Painted Multi Access Tile Upper Deck Location | IN13.5MAP30-UD | 13.5" | 30" | \$103 | +\$13 |
| | | IN13.5MAP36-UD | 13.5" | 36" | \$107 | +\$15 |
| | | IN13.5MAP42-UD | 13.5" | 42" | \$112 | +\$15 |
| | | IN13.5MAP48-UD | 13.5" | 48" | \$119 | +\$15 |
| | | IN13.5MAP54-UD | 13.5" | 54" | \$120 | +\$16 |
| | | IN13.5MAP60-UD | 13.5" | 60" | \$124 | +\$16 |
|  | 6.75" H Painted Multi Access Tile Beltline Location | IN6.75MAP30-BL | 6.75" | 30" | \$74 | +\$11 |
| | | IN6.75MAP36-BL | 6.75" | 36" | \$76 | +\$11 |
| | | IN6.75MAP42-BL | 6.75" | 42" | \$79 | +\$11 |
| | | IN6.75MAP48-BL | 6.75" | 48" | \$81 | +\$11 |
| | | IN6.75MAP54-BL | 6.75" | 54" | \$87 | +\$12 |
| | | IN6.75MAP60-BL | 6.75" | 60" | \$90 | +\$12 |
|  | 13.5" H Painted Multi Access Tile Beltline Location | IN13.5MAP30-BL | 13.5" | 30" | \$103 | +\$13 |
| | | IN13.5MAP36-BL | 13.5" | 36" | \$107 | +\$15 |
| | | IN13.5MAP42-BL | 13.5" | 42" | \$112 | +\$15 |
| | | IN13.5MAP48-BL | 13.5" | 48" | \$119 | +\$15 |
| | | IN13.5MAP54-BL | 13.5" | 54" | \$120 | +\$16 |
| | | IN13.5MAP60-BL | 13.5" | 60" | \$124 | +\$16 |
|  | 20.25" H Painted Multi Access Tile Bottom Location | IN20.25MAP30-BS | 20.25" | 30" | \$138 | +\$17 |
| | | IN20.25MAP36-BS | 20.25" | 36" | \$140 | +\$17 |
| | | IN20.25MAP42-BS | 20.25" | 42" | \$147 | +\$18 |
| | | IN20.25MAP48-BS | 20.25" | 48" | \$157 | +\$19 |
| | | IN20.25MAP54-BS | 20.25" | 54" | \$174 | +\$20 |
| | | IN20.25MAP60-BS | 20.25" | 60" | \$178 | +\$21 |

Architecture

Tiles
Multi Access - Fabric

System

PRODUCT CODE KEY EXAMPLE

IN6.75MAF30

| | |
|-------------|---------------------|
| IN | Inscape System |
| 6.75 | 6.75" H |
| MAF | Multi Access Fabric |
| 30 | 30" W |

- Fabric applied in a railroad orientation as standard
- Fabric tile is magnetic.
- Specific locations where these tiles may be installed on frame; *See *Inscape System Application Guide*
- Flush bezel color option of black (default), white and gray
- Be sure to confirm crossrail locations will accommodate tile height
- Crossrails can be found in the accessory section of the price list under Panel and Table accessories

NOTES

Code suffix denote specific tile location:

UD = Upper deck

BL = Beltline

BS = Base





See finishes section for fabrics that requires scrim

Tile size limitations exist for some fabrics, see finishes section

In order to get a total cost on products when upcharges are present take the list price of the product number and add the upcharge cost shown to the list price.

For example:

Product IN6.75MAF30-UD in Grade 2 with scrim would be \$94 +\$7 +\$15

| | Part number | W | Grade 1/ COM/ Base price | Grade 2 | Grade 3 | Grade 4 | Grade 5 | Grade 6 | Grade 7 | Grade 8 | Scrim |
|---|------------------------|-----|--------------------------------|---------|---------|---------|---------|---------|---------|---------|-------|
|  6.75" H Fabric Multi Access Tile Upper Deck Location | IN6.75MAF30-UD | 30" | \$94 | +\$7 | +\$9 | +\$13 | +\$18 | +\$35 | +\$53 | +\$73 | +\$15 |
| | IN6.75MAF36-UD | 36" | \$105 | +\$9 | +\$12 | +\$21 | +\$25 | +\$50 | +\$70 | +\$97 | +\$16 |
| | IN6.75MAF42-UD | 42" | \$110 | +\$10 | +\$11 | +\$21 | +\$27 | +\$52 | +\$72 | +\$101 | +\$16 |
| | IN6.75MAF48-UD | 48" | \$114 | +\$10 | +\$13 | +\$22 | +\$30 | +\$53 | +\$77 | +\$106 | +\$16 |
| | IN6.75MAF54-UD | 54" | \$120 | +\$11 | +\$13 | +\$22 | +\$30 | +\$54 | +\$79 | +\$108 | +\$16 |
| | IN6.75MAF60-UD | 60" | \$131 | +\$11 | +\$13 | +\$24 | +\$34 | +\$63 | +\$91 | +\$127 | +\$17 |
|  13.5" H Fabric Multi Access Tile Upper Deck Location | IN13.5MAF30-UD | 30" | \$120 | +\$8 | +\$12 | +\$21 | +\$29 | +\$53 | +\$77 | +\$106 | +\$17 |
| | IN13.5MAF36-UD | 36" | \$131 | +\$9 | +\$16 | +\$27 | +\$39 | +\$69 | +\$98 | +\$135 | +\$17 |
| | IN13.5MAF42-UD | 42" | \$134 | +\$10 | +\$23 | +\$29 | +\$44 | +\$72 | +\$103 | +\$143 | +\$18 |
| | IN13.5MAF48-UD | 48" | \$139 | +\$12 | +\$25 | +\$35 | +\$46 | +\$76 | +\$106 | +\$147 | +\$18 |
| | IN13.5MAF54-UD | 54" | \$140 | +\$13 | +\$27 | +\$39 | +\$50 | +\$84 | +\$114 | +\$160 | +\$20 |
| | IN13.5MAF60-UD | 60" | \$153 | +\$15 | +\$30 | +\$43 | +\$52 | +\$87 | +\$116 | +\$162 | +\$20 |
|  6.75" H Fabric Multi Access Tile Beltline Location | IN6.75MAF30-BL | 30" | \$94 | +\$7 | +\$9 | +\$13 | +\$18 | +\$35 | +\$53 | +\$73 | +\$15 |
| | IN6.75MAF36-BL | 36" | \$105 | +\$9 | +\$11 | +\$21 | +\$26 | +\$48 | +\$61 | +\$88 | +\$16 |
| | IN6.75MAF42-BL | 42" | \$110 | +\$10 | +\$11 | +\$21 | +\$27 | +\$50 | +\$72 | +\$101 | +\$16 |
| | IN6.75MAF48-BL | 48" | \$114 | +\$10 | +\$13 | +\$22 | +\$30 | +\$53 | +\$77 | +\$106 | +\$16 |
| | IN6.75MAF54-BL | 54" | \$120 | +\$11 | +\$13 | +\$22 | +\$30 | +\$54 | +\$79 | +\$108 | +\$16 |
| | IN6.75MAF60-BL | 60" | \$131 | +\$11 | +\$13 | +\$24 | +\$34 | +\$63 | +\$91 | +\$127 | +\$17 |
|  13.5" H Fabric Multi Access Tile Beltline Location | IN13.5MAF30-BL | 30" | \$120 | +\$7 | +\$12 | +\$21 | +\$29 | +\$53 | +\$77 | +\$106 | +\$17 |
| | IN13.5MAF36-BL | 36" | \$131 | +\$9 | +\$16 | +\$27 | +\$34 | +\$65 | +\$96 | +\$121 | +\$17 |
| | IN13.5MAF42-BL | 42" | \$134 | +\$8 | +\$20 | +\$29 | +\$37 | +\$67 | +\$98 | +\$135 | +\$18 |
| | IN13.5MAF48-BL | 48" | \$139 | +\$12 | +\$25 | +\$35 | +\$46 | +\$76 | +\$106 | +\$147 | +\$18 |
| | IN13.5MAF54-BL | 54" | \$140 | +\$13 | +\$27 | +\$39 | +\$50 | +\$84 | +\$114 | +\$160 | +\$20 |
| | IN13.5MAF60-BL | 60" | \$153 | +\$6 | +\$16 | +\$27 | +\$42 | +\$73 | +\$105 | +\$146 | +\$20 |
|  20.25" H Fabric Multi Access Tile Bottom Location | IN20.25MAF30-BS | 30" | \$140 | +\$7 | +\$22 | +\$32 | +\$44 | +\$73 | +\$103 | +\$143 | +\$29 |
| | IN20.25MAF36-BS | 36" | \$162 | +\$9 | +\$22 | +\$34 | +\$48 | +\$85 | +\$119 | +\$166 | +\$30 |
| | IN20.25MAF42-BS | 42" | \$167 | +\$9 | +\$20 | +\$33 | +\$47 | +\$85 | +\$119 | +\$166 | +\$31 |
| | IN20.25MAF48-BS | 48" | \$171 | +\$12 | +\$29 | +\$44 | +\$56 | +\$96 | +\$133 | +\$185 | +\$31 |
| | IN20.25MAF54-BS | 54" | \$174 | +\$12 | +\$31 | +\$47 | +\$61 | +\$103 | +\$143 | +\$201 | +\$32 |
| | IN20.25MAF60-BS | 60" | \$179 | +\$15 | +\$33 | +\$58 | +\$74 | +\$119 | +\$162 | +\$225 | +\$33 |

Architecture

Tiles
Double Glazed

System

PRODUCT CODE KEY EXAMPLE

IN13.5GL24-3F

| | |
|-------------|------------------------|
| IN | Inscape System |
| 1.35 | 13.5" H |
| GL24 | 24" W double glaze |
| 3F | for 3 1/2" thick frame |

- "2F" denotes use with 2 3/4" thick frame, "3F" denotes use with 3 1/2" thick frame
- Be sure to confirm crossrail locations will accommodate tile height
- Crossrails can be found in the accessory section of the price list under Panel and Table accessories



NOTES

Standard tiles may NOT be installed in locations above Double Glaze Tile on the 2 3/4" thick frame

In order to get a total cost on products when upcharges are present take the list price of the product number and add the upcharge cost shown to the list price.

For example:

IN13.5GL24-3F in Frosted Acrylic would be \$329 +\$42





| | | Part number | H | W | Clear acrylic/ base price | Frosted acrylic | Accent paint |
|---|--|----------------------|-------|-----|------------------------------|--------------------|-----------------|
|  | Double Glaze Tile for 3 1/2" Frames | IN13.5GL24-3F | 13.5" | 24" | \$329 | +\$42 | +\$35 |
| | | IN13.5GL30-3F | 13.5" | 30" | \$343 | +\$54 | +\$36 |
| | | IN13.5GL36-3F | 13.5" | 36" | \$356 | +\$58 | +\$37 |
| | | IN13.5GL42-3F | 13.5" | 42" | \$381 | +\$88 | +\$42 |
| | | IN13.5GL48-3F | 13.5" | 48" | \$391 | +\$98 | +\$43 |
|  | Double Glaze Tile for 2 3/4" Frames | IN13.5GL24-2F | 13.5" | 24" | \$317 | +\$42 | +\$33 |
| | | IN13.5GL30-2F | 13.5" | 30" | \$331 | +\$54 | +\$35 |
| | | IN13.5GL36-2F | 13.5" | 36" | \$344 | +\$58 | +\$36 |
| | | IN13.5GL42-2F | 13.5" | 42" | \$369 | +\$88 | +\$39 |
| | | IN13.5GL48-2F | 13.5" | 48" | \$378 | +\$98 | +\$42 |

**PRODUCT CODE
 KEY EXAMPLE**

IN37P18

| | |
|-----------|----------------|
| IN | Inscape System |
| 37 | 37" H |
| P | Painted |
| 18 | 18" W |

- Painted tiles are available in any of Inscape's standard paint colors or a custom color can be accommodated
- Painted tile is magnetic.
- Be sure to confirm crossrail locations will accommodate tile height
- Crossrails can be found in the accessory section of the price list under Panel and Table accessories

| | | Part number | H | W | Neutral paint/ base price | Accent paint |
|---|-------------------------------|----------------|-----|-----|------------------------------|-----------------|
|  | 37" H Painted Monolithic Tile | IN37P18 | 37" | 18" | \$171 | +\$20 |
| | | IN37P24 | 37" | 24" | \$177 | +\$20 |
| | | IN37P30 | 37" | 30" | \$180 | +\$21 |
| | | IN37P36 | 37" | 36" | \$185 | +\$21 |
| | | IN37P42 | 37" | 42" | \$188 | +\$21 |
| | | IN37P48 | 37" | 48" | \$192 | +\$22 |
|  | 44" H Painted Monolithic Tile | IN44P18 | 44" | 18" | \$197 | +\$22 |
| | | IN44P24 | 44" | 24" | \$204 | +\$23 |
| | | IN44P30 | 44" | 30" | \$211 | +\$23 |
| | | IN44P36 | 44" | 36" | \$218 | +\$24 |
| | | IN44P42 | 44" | 42" | \$225 | +\$25 |
| | | IN44P48 | 44" | 48" | \$231 | +\$25 |
|  | 51" H Painted Monolithic Tile | IN51P18 | 51" | 18" | \$209 | +\$23 |
| | | IN51P24 | 51" | 24" | \$219 | +\$24 |
| | | IN51P30 | 51" | 30" | \$223 | +\$25 |
| | | IN51P36 | 51" | 36" | \$231 | +\$25 |
| | | IN51P42 | 51" | 42" | \$243 | +\$26 |
| | | IN51P48 | 51" | 48" | \$252 | +\$27 |
|  | 57" H Painted Monolithic Tile | IN57P18 | 57" | 18" | \$221 | +\$24 |
| | | IN57P24 | 57" | 24" | \$231 | +\$25 |
| | | IN57P30 | 57" | 30" | \$245 | +\$26 |
| | | IN57P36 | 57" | 36" | \$251 | +\$27 |
| | | IN57P42 | 57" | 42" | \$260 | +\$29 |
| | | IN57P48 | 57" | 48" | \$273 | +\$30 |
|  | 64" H Painted Monolithic Tile | IN64P18 | 64" | 18" | \$247 | +\$26 |
| | | IN64P24 | 64" | 24" | \$262 | +\$29 |
| | | IN64P30 | 64" | 30" | \$278 | +\$30 |
| | | IN64P36 | 64" | 36" | \$294 | +\$32 |
| | | IN64P42 | 64" | 42" | \$306 | +\$33 |
| | | IN64P48 | 64" | 48" | \$317 | +\$33 |

Architecture

Tiles
Monolithic - Fabric

System

PRODUCT CODE KEY EXAMPLE

IN37F18

| | |
|-----------|----------------|
| IN | Inscape System |
| 37 | 37" H |
| F | Fabric |
| 18 | 18" W |

- Fabric applied in a railroad orientation as standard
- Fabric tile is magnetic
- Be sure to confirm crossrail locations will accommodate tile height
- Crossrails can be found in the accessory section of the price list under Panel and Table accessories

NOTES





See finishes section for fabrics that requires scrim.

Tile size limitations exist for some fabrics, see finishes section.

In order to get a total cost on products when upcharges are present take the list price of the product number and add the upcharge cost shown to the list price.

For example:

Product IN37F18 in Grade 2 with scrim would be \$258 +\$15 +\$33

| | Part number | W | Grade 1/ COM/ Base price | Grade 2 | Grade 3 | Grade 4 | Grade 5 | Grade 6 | Grade 7 | Grade 8 | Scrim |
|---|----------------|-----|--------------------------------|---------|---------|---------|---------|---------|---------|---------|--------|
|  | IN37F18 | 18" | \$258 | +\$15 | +\$21 | +\$30 | +\$37 | +\$73 | +\$108 | +\$152 | +\$33 |
| | IN37F24 | 24" | \$272 | +\$16 | +\$22 | +\$30 | +\$37 | +\$76 | +\$112 | +\$157 | +\$44 |
| | IN37F30 | 30" | \$283 | +\$16 | +\$22 | +\$31 | +\$39 | +\$79 | +\$118 | +\$165 | +\$53 |
| | IN37F36 | 36" | \$294 | +\$30 | +\$34 | +\$51 | +\$66 | +\$119 | +\$170 | +\$237 | +\$63 |
| | IN37F42 | 42" | \$312 | +\$30 | +\$35 | +\$51 | +\$66 | +\$121 | +\$174 | +\$245 | +\$72 |
| | IN37F48 | 48" | \$322 | +\$31 | +\$36 | +\$53 | +\$69 | +\$127 | +\$182 | +\$253 | +\$85 |
| 37" H Fabric Monolithic Tile | | | | | | | | | | | |
|  | IN44F18 | 18" | \$287 | +\$20 | +\$23 | +\$33 | +\$45 | +\$84 | +\$120 | +\$168 | +\$39 |
| | IN44F24 | 24" | \$304 | +\$20 | +\$23 | +\$33 | +\$45 | +\$86 | +\$126 | +\$173 | +\$52 |
| | IN44F30 | 30" | \$319 | +\$22 | +\$25 | +\$34 | +\$46 | +\$89 | +\$130 | +\$180 | +\$64 |
| | IN44F36 | 36" | \$333 | +\$33 | +\$42 | +\$45 | +\$73 | +\$133 | +\$194 | +\$273 | +\$76 |
| | IN44F42 | 42" | \$348 | +\$33 | +\$42 | +\$57 | +\$77 | +\$139 | +\$200 | +\$276 | +\$90 |
| | IN44F48 | 48" | \$364 | +\$33 | +\$42 | +\$59 | +\$77 | +\$139 | +\$200 | +\$278 | +\$101 |
| 44" H Fabric Monolithic Tile | | | | | | | | | | | |
|  | IN51F18 | 18" | \$314 | +\$21 | +\$25 | +\$36 | +\$47 | +\$89 | +\$129 | +\$178 | +\$46 |
| | IN51F24 | 24" | \$328 | +\$22 | +\$26 | +\$37 | +\$50 | +\$96 | +\$139 | +\$195 | +\$60 |
| | IN51F30 | 30" | \$343 | +\$24 | +\$27 | +\$42 | +\$58 | +\$98 | +\$143 | +\$204 | +\$74 |
| | IN51F36 | 36" | \$357 | +\$34 | +\$30 | +\$63 | +\$83 | +\$140 | +\$199 | +\$277 | +\$91 |
| | IN51F42 | 42" | \$374 | +\$35 | +\$46 | +\$64 | +\$84 | +\$143 | +\$206 | +\$286 | +\$104 |
| | IN51F48 | 48" | \$388 | +\$37 | +\$48 | +\$66 | +\$87 | +\$145 | +\$210 | +\$292 | +\$120 |
| 51" H Fabric Monolithic Tile | | | | | | | | | | | |
|  | IN57F18 | 18" | \$326 | +\$26 | +\$32 | +\$46 | +\$57 | +\$104 | +\$152 | +\$211 | +\$51 |
| | IN57F24 | 24" | \$342 | +\$29 | +\$33 | +\$47 | +\$59 | +\$111 | +\$164 | +\$226 | +\$66 |
| | IN57F30 | 30" | \$357 | +\$34 | +\$37 | +\$48 | +\$61 | +\$116 | +\$170 | +\$237 | +\$85 |
| | IN57F36 | 36" | \$375 | +\$44 | +\$49 | +\$77 | +\$98 | +\$168 | +\$238 | +\$331 | +\$99 |
| | IN57F42 | 42" | \$394 | +\$45 | +\$53 | +\$81 | +\$99 | +\$170 | +\$242 | +\$336 | +\$115 |
| | IN57F48 | 48" | \$411 | +\$46 | +\$56 | +\$84 | +\$100 | +\$174 | +\$250 | +\$348 | +\$131 |
| 57" H Fabric Monolithic Tile | | | | | | | | | | | |
|  | IN64F18 | 18" | \$348 | +\$26 | +\$32 | +\$46 | +\$57 | +\$104 | +\$152 | +\$211 | +\$57 |
| | IN64F24 | 24" | \$369 | +\$29 | +\$34 | +\$47 | +\$59 | +\$111 | +\$164 | +\$226 | +\$74 |
| | IN64F30 | 30" | \$387 | +\$33 | +\$42 | +\$48 | +\$61 | +\$116 | +\$170 | +\$237 | +\$94 |
| | IN64F36 | 36" | \$407 | +\$37 | +\$56 | +\$77 | +\$98 | +\$168 | +\$238 | +\$331 | +\$112 |
| | IN64F42 | 42" | \$430 | +\$44 | +\$57 | +\$81 | +\$102 | +\$170 | +\$242 | +\$336 | +\$131 |
| | IN64F48 | 48" | \$449 | +\$46 | +\$59 | +\$84 | +\$104 | +\$174 | +\$250 | +\$348 | +\$148 |
| 64" H Fabric Monolithic Tile | | | | | | | | | | | |

Architecture

Tiles

Planna Storage Benching Multi Access

System

PRODUCT CODE
KEY EXAMPLE

IN6.75MAP30B

INPL Inscape System
Planna

6.75 6.75" H

MAP Multi access - painted

30 30" W

- Use with 3.5" thick panel only
- Paint finish only
- Painted tiles are available in any of Inscape's standard paint colors or a custom color can be accommodated
- Painted tile is magnetic
- Flush bezel color option of black (default), white and gray
- Be sure to confirm crossrail locations will accommodate tile height
- Crossrails can be found in the accessory section of the price list under Panel and Table accessories



6.75" H Painted Multi
Access Tile
for use with Planna
Storage

| Part number | H | W | Neutral paint/ base price | Accent paint |
|----------------------|-------|-----|------------------------------|-----------------|
| INPL6.75MAP30 | 6.75" | 30" | \$104 | +\$13 |
| INPL6.75MAP36 | 6.75" | 36" | \$107 | +\$15 |
| INPL6.75MAP42 | 6.75" | 42" | \$115 | +\$15 |

Architecture

Tiles
Foam Bumper

System

The Foam Bumpers are required for the following tiles then they are used directly below a top can on a 3.5" frame:

- 13 1/2" h tiles that are 54" or 60" wide that are NOT Screen, Tackable, Wall Mounted Tackable or Whiteboard require 1 bumper
- 20 1/4" h tiles that are 54" or 60" wide that are NOT Screen, Tackable, Wall Mounted Tackable or Whiteboard require 1 bumper
- Whiteboard tiles 36" wide or wider require 2 bumpers
- 27" h tiles that are 48" wide that are NOT Nuform require 2 bumpers

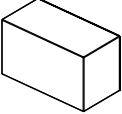
| | Part number | H | W | List price | |
|---|--------------------------------------|-------------|---|------------|-----|
|  | Foam Bumper for back of select tiles | QSDB | — | — | \$0 |

System Technology

inscape

work for tomorrow

Inscape System electrical is UL and CSA approved. New York City and Chicago solutions are also available as standard offering. The electrical system features 8 wires and 4 circuits that can be configured in a 2+2 or 3+1 circuit configuration. All electrical components, with the exception of the power feed (which must be connected to the building power supply by a licensed electrician) may be installed by furniture installers, unless otherwise stated by jurisdiction of the installation.

Inscape System electrical components consist of the following: Floor/Wall power in-feed, ceiling power in-feed, chimney feed, power tracks, jumper cables and duplex receptacles. Power components snap into place without the need of tools.

POWER IN-FEED CONNECTIONS

Power in-feed connections can be made through a wall, column, or floor connection. Power in-feed connections consist of an 84" long liquid tight cable and a 45" flex cable connected by a 3" metal coupler and elbow joint to sit between bottom rails. The liquid tight portion of the Power in-feed must be connected to the building power supply by an electrician.

If two power feeds are being specified for one cluster of stations, care must be taken not to cross connect the two feeds through jumper cables and power tracks.

New York City has requirements for special power entry assemblies. A qualified electrician is required to hard-wire the **New York City In-feed** from the entry box to the power source. The New York City feed works for side feed, end feed or ceiling feed.

The City of Chicago does not permit the use of pre-wired modular electrical systems. To simplify hardwiring of the Inscape System panel, the **City of Chicago Hold Down Bracket** is available. When requiring power and data in the beltline location, it is required that basic frames be specified with the width specific code (ECHB-BL-). The beltline location code includes the beltline cover as well as the City of Chicago Hold Down bracket which is based on the width of the frame. When specifying in locations other than at the beltline, an attachment bracket (INECHB) is available. Specify two INECHB for each power entry point, one for the power feed and one for the outlet. (The outlet box is NOT supplied by Inscape). INECHB's are available in packages of 6. **Boxes should be sourced through Ental Industries or J&A Sheet both local Chicago suppliers of electrical junction boxes.**

NOTE: Panels 30" W will accept one double-sided outlet box. Panels 36" W and wider will accept two boxes. INECHB's may also be specified to mount multi-user termination boxes inside the panel.

WIRE DESIGNATION

2 + 2 Circuit Configuration

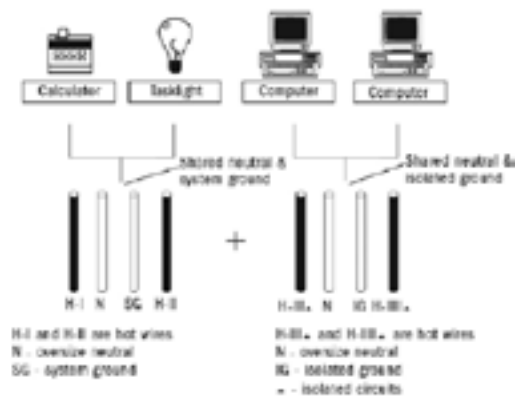

2+2

- Circuits #1 and #2 share one oversize neutral and one shared ground to provide convenience power for task lights, calculators, radios etc.
- Circuits #3 and #4 share the other oversize neutral and isolated ground to provide isolated power to computers.

3 + 1 Circuit Configuration

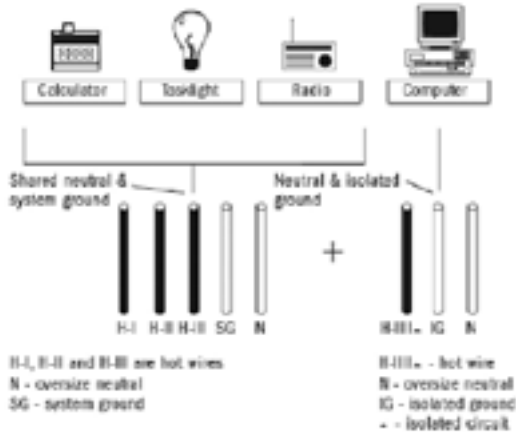

3+1

- Circuits #1, #2 and #3 share one oversize neutral and one shared ground to provide convenience power for task lights, calculators, radios etc.
- Circuit #4 uses the other oversize neutral and isolated ground to provide isolated power to computers.

CEILING POWER AND DATA FEEDS KIT

Ceiling power and data feeds kit includes a split top trim to facilitate cable entry into the panel, a ceiling grommet, a 16' long electrical cable and power pole featuring a septum to separate power from data cables to avoid electromagnetic interference (EMI). Specify ceiling power pole according to panel width. The ceiling power entry cable must be connected to the building power supply by an electrician. If two power feeds are being specified for one cluster of stations, care must be taken not to cross connect the two feeds through jumper cables and power tracks. The entire power pole accommodates 61 Cat6 and 78 Cat5 cables at a 60% fill capacity if no electrical cable is routed through pole. If electrical is routed within power pole, at a 60% fill capacity, 46 Cat6 and 59 Cat5 cables may be accommodated.



THE CHIMNEY CEILING FEED

The chimney ceiling feed carries up to 99 Cat6 or 128 Cat5 cables from the ceiling into the panel at 60% capacity when electrical is routed within chimney feed as well. If only data is being routed through Chimney Feed 147 Cat6 or 189 Cat5 cables may be routed through the chimney feed. The chimney kit consists of an 18" W Basic frame which includes an internal channel, ceiling collar (white only), and top trim. A septum within the chimney feed separates power and data cables. All tiles and vertical end trim must be specified separately. The 16' power entry cable is optional and is specified by the appropriate code.



POWER TRACKS

Power tracks are specified for frames 30" W and wider. This power track mounts at the beltline location of a 3 ½" thick Standard frame by clips that are shipped with the frame. The 30" W power track accepts one duplex per side. A power track 36" W and wider accepts two duplexes per side. Power tracks do not include jumper cables. Jumper cables must be specified to carry power from track to track (see Application Guide for length requirements).

POWER TRACK KITS

Power track kits consist of a power track and clips to attach the power track to a crossrail. The kit allows for power tracks to be mounted in all locations of the 2 ¾" thick panel and in locations other than the beltline location in the 3 ½" thick standard frames. Jumper cables and receptacles are specified separately. The 30" W Power Track Kit accepts one duplex per side. Power Track Kits which are 36" W and wider accept two duplexes per side. Power Track Kits may be specified below the following; Transaction Tops, Up mount Bins, Stack on Glaze, Add on Glaze and Double Glazed Tiles. Power Track Kits MAY NOT be specified below Twin Bins or Power Poles.

JUMPER CABLES

Jumper cables by-pass non-powered panels and also facilitates connections from power track to power track. Jumper cables must attach to power tracks only and cannot be attached to adjacent jumper cables or power in-feeds. Product codes indicate the width of the jumper cable which may be cross-referenced in the Inscape System Application Guide. Various widths of jumper cables are available to facilitate various applications and configurations.

**See Inscape System Application Guide for details.*

DUPLEX RECEPTACLES

Duplex receptacles snap into power tracks back-to-back and may be accessed through cutouts in either the electrical cover plate with standard frames or multi-access and communication tiles in all other locations and basic frames. Duplexes are interchangeable amongst the varying power track locations. However, specific duplexes are required for various frame thicknesses and Electrified Storage, and need to be specified accordingly. Specify duplexes according to circuit configuration, 2+2 or 3+1. The IN3D3-_ duplex is specific to 2+2 wire configurations and the IN3DU3-_ duplex is specified for 3+1 wire configurations. General rule is no more than 12 receptacles per circuit per power in feed. Duplexes may be specified in black, white (close match to P168 – Glacier White) and gray (close match to P290 – Aluminum Leaf).

Controlled receptacles to satisfy California Title 24 are available. These receptacles control circuits through building switches. When circuits are controlled through building switches, it is required to identify which circuit is controlled to the end user. To identify the receptacles on the controlled circuit, Inscape's controlled receptacles have a power mark (circle with the vertical line). The fit and function of these receptacles are same as the standard receptacle offering only application is in controlled circuits.

USB receptacles are also available. The snap into the standard power track. Each module provides 2 amp output via 2 USB ports and are available for both 2+2 and 3+1 wire configurations. Duplexes may be specified in black, white (close match to P168 – Glacier White) and gray (close match to P290 – Aluminum Leaf.)

TASK LIGHTS

The LED task light is 20" in length and is silver in color. It is 7.5" W and has light color of cool white; 4,500° - 5,500°. The LED task light may be positioned on an overhead bin, shelf or twin bin. When mounted, because of its height of 7/8" H, it is not as visible as other task lights. This task light is magnetic but can also be mounted with screws if needed.

The Tuck Light comes in three length options; 17", 31" and 44". These options are nominal, see dimension info on pricing chart for actual dimensions. It is an LED fixture that comes stand in silver with black endcaps and frosted lens. This light offers 18-watt wall transformer with 9' black cord. The light output can be customized with the touch-and-hold dimming feature. Each code comes with one light fixture, one on/off/dimmer pack, one 18-watt power supply, magnet or screw mount options and two cord managers.

DATA COMPONENTS

DATA HANGER BRACKET

The Data Hanger Bracket provides a place for a voice/data box to be installed within the panel behind the tile (voice/data box not included). The bracket will accommodate up to a 6 outlet faceplate and is packaged in pairs.

HINGED COVER (INHRC)

The hinged cover (INHRC) snaps into the cutouts which are found in multi access and communication tiles. When data faceplates and receptacles are not required the hinged cover provides a visual and protective cover.

FIBER OPTIC OUTLET (INCFO)

Fiber optic outlet (INCFO) is specified to be installed in a cutout in a multi access or communication tile. May be specified in black, white (close match to P168 – Glacier White) and gray (close match to P290 – Aluminum Leaf).

DATA AND COMMUNICATION FACEPLATE (INCDP)

The data and communication faceplate (INCDP) installs in a cutout in a multi access or communication tile where plug and play access is required. The faceplate provides three “slots” where the Category 5 (INCABRJ45), Category 6 (INCABR6J45), and/or Telephone Jacks (INCRJ11) may be inserted. All “openings” need to be filled with data or phone jacks, The Blank Data Plate Insert (INCB) fills in any which are not being used. Data components may be specified in black, white (close match to P168 – Glacier White) and gray (close match to P290 – Aluminum Leaf). Telephone Jacks (INCRJ11) are not available in gray. Data Communication Plates (INCDP) are not currently available in white.

WORKSURFACE GROMMETS

Worksurface grommets are field installed and instructions are available. Inscape cannot and will not be held responsible for the quality of workmanship executed by any installation firm engaged to provide grommet-cutting services required for the field installation of our grommet sleeve/cap offering.

CLAMP-ON POWER MODULES

Clamp-on power may be clamped along edge of worksurface for plug and play access to electrical/voice/data. Power Modules plug into the duplexes and attach to 1” and 1 ¼” thick worksurfaces.

The Clamp-On Power Module has a 3 receptacle/1 dual USB port configuration and is available in a black or white finish. It has a 96” long power cord and LED surge protection indication. The mount includes a device holder.

The Clamp-On Power Module with Colored Components comes in many different configurations with receptacles, USB (1 type A and 1 type B) ports and availability lights. Power Modules come in black, white or gray and have colored options for the lid; Black, White, Teal, Red, Purple, Blue, Green, Gray. The availability light is user controlled and requires free software download.

CABLE HOOKS

Cable Hooks support and segregate data cables. Each frame 37” and higher ships with one cable manager. Cable hooks carry data cables to their termination voice/data point at a multi access or communication tile for plug and play access or to hanger brackets which are located behind the tile.

WIRE MANAGEMENT CLIPS

Wire management clips are required when power is being routed from a Credenza Storage benching application frame to the worksurface. Where cabling is running from behind a Credenza Storage case, these wire management clips are mounted to the underside of the inside of the case and the wires are cleanly routed to the main surface. These clips come in a package of 10 and are white in color.

WIRE CASING

Wire casing manages cables and technology from a worksurface to the floor. Casing is 29” long but can be adjustable in length by removing or adding “links”. Casing is available in gray. As standard the wire casing accommodates 28.5” H worksurface heights. The wire casing accommodates 30 Cat5 cables with electrical works at a 60% fill capacity which is recommended. Approximately 36 Cat5 cables may be accommodated in the wire casing at a 60% fill capacity without electrical works.

POWER BAR

Power bar is a white power bar consisting of 6 outlets and a 10’ cord which may be specified to provide additional outlets. Addition of power bars should be taken into account when determining the amount of power required for a single or a cluster of stations. The power bar may be mounted under the worksurface.

ELECTRIFIED STORAGE COMPLIMENT TECHNOLOGY COMPONENTS

Electrified storage compliment technology components have been designed to fit within or compliment the Electrified Storage case. These components essentially work the same as the frame components but are specified based on specific lengths in relation to Electrified Storage.

ELECTRIFIED STORAGE CABLE CLOSETS

The electrified storage cable closets are designed to facilitate technology entering the Electrified Storage cases if a panel is not present. The cable closet is specified for the end of an Electrified Storage single case or run of cases. The closet is 1 ½" space thick, 18" W and is specified based on the height of the case with which it is mounting to. Technology may enter the cable closet via the floor or ceiling. Specify correct closet for desired application.

When ceiling feed is required, the **Cable Feed Kit** for the cable closet is required to be specified separately based on the ceiling height. Cable closets which attach to the 1 ½" screen are available to allow for technology to enter an Electrified Storage unit when the 1 ½" screen is being utilized which does not carry power. Be sure to specify inline connectors for the connection of this cable closet to the screen. Closets include all hardware to attach to the Electrified Storage case.

NOTE: Holes are required to be drilled in the case in order to attach cable closet brackets.



ELECTRICAL MODULE SIDE COVER

Electrical module side cover is specified for the end of an Electrified Storage unit to conceal the technology zone when a panel, screen or cable closet is not specified. This is a value engineered solution for the finishing of an Electrified Storage run. This cover may be painted the same colors as the Electrified Storage cases.

ELECTRICAL MODULE FRONT COVER

Electrical module front cover come standard with all Electrified Storage base cases; one side with cutout and one side without. When the configuration of an Electrified Storage base unit calls for additional cutouts or no cutouts on the other side of the unit, the appropriate front cover may be specified. The 30" W front cover only includes one cutout.



- Power in-feed connections consist of an 84" long liquid tight cable and a 45" flex cable connected by a 3" metal coupler and elbow joint to sit between bottom rails
- All electrical components are standard 8 wire configuration

| | Part number | List price |
|---|--------------------|--------------|
|  <p>Standard Floor/Wall Power In Feed Kits</p> | INEFWK-8 | \$361 |
|  <p>New York City Power In Feed Kit</p> | INEFWK-NY-8 | \$641 |

- The ceiling power pole accommodates a maximum ceiling height of 11' when placed atop any systems frame height
- See Inscape System Application Guide for compatibility with ceiling heights
- Power pole kit includes top trim, power pole (exposed height noted below) and electrical power in-feed
- "2F" denotes use with 2 ¾" thick frame
"3F" denotes use with 3 ½" thick frame

NOTES

- Beltline Power Track or Power Track Kit must be located in frame where power pole is entering in order for in-feed to connect

| | Part number | H | W | Tapered | Flat | Accent paint | |
|---|--|----------------------|------|---------|--------|--------------|--------|
|  | Ceiling Power Pole Kit For use with 3 ½" T Frames | INECFK24-8-3F | 113" | 24" | \$1169 | \$1169 | +\$120 |
| | | INECFK30-8-3F | 113" | 30" | \$1176 | \$1176 | +\$120 |
| | | INECFK36-8-3F | 113" | 36" | \$1183 | \$1183 | +\$121 |
| | | INECFK42-8-3F | 113" | 42" | \$1194 | \$1194 | +\$123 |
| | | INECFK48-8-3F | 113" | 48" | \$1200 | \$1200 | +\$123 |
| | | INECFK54-8-3F | 113" | 54" | \$1217 | \$1217 | +\$125 |
| | | INECFK60-8-3F | 113" | 60" | \$1222 | \$1222 | +\$125 |
|  | Ceiling Power Pole Kit For use with 2 ¾" T Frames | INECFK24-8-2F | 113" | 24" | — | \$1169 | +\$120 |
| | | INECFK30-8-2F | 113" | 30" | — | \$1176 | +\$120 |
| | | INECFK36-8-2F | 113" | 36" | — | \$1183 | +\$121 |
| | | INECFK42-8-2F | 113" | 42" | — | \$1194 | +\$123 |
| | | INECFK48-8-2F | 113" | 48" | — | \$1200 | +\$123 |
| | | INECFK54-8-2F | 113" | 54" | — | \$1217 | +\$125 |
| | | INECFK60-8-2F | 113" | 60" | — | \$1222 | +\$125 |

- Chimney Feed Kit consists of an 18" W frame and top cap as well as electrical if optioned
- Tiles may span the 18" W Chimney frame along with adjacent frame (see Inscape System Application Guide for acceptable spans)
- "2F" denotes use with 2 ¾" thick frame
- "3F" denotes use with 3 ½" thick frame
- 96" version is a 64" H frame with additional 27" H stack
- 104" version is a 64" H frame with additional 27" and 13.5" H stack

NOTES

- Tiles, vertical trim, inline connectors or corner connectors are specified separately
- A Beltline power track or a Power Track Kit must be specified in directly adjacent panel to the Chimney Power Feed Frame
- 96" H Chimney Power Feed Frame to be ordered for ceiling heights of 8' +/-6"
- 104" H Chimney Power Feed Frame to be ordered for ceiling height of 9' +/-6"

| | | Part number | H | W | Tapered | Flat | Accent paint |
|---|---|------------------------|------|-----|---------|--------|--------------|
| i | Chimney Power Feed Frame with Electrical For use with 3 ½" T Frames | INCF1896E-8-3F | 96" | 18" | \$1737 | \$1737 | +\$177 |
| | | INCF18104E-8-3F | 104" | 18" | \$2014 | \$2014 | +\$204 |
| i | Chimney Power Feed Frame without Electrical For use with 3 ½" T Frame | INCF1896-8-3F | 96" | 18" | \$1691 | \$1691 | +\$172 |
| | | INCF18104-8-3F | 104" | 18" | \$1967 | \$1967 | +\$199 |
| i | Chimney Power Feed Frame with Electrical For use with 2 ¾" T Frames | INCF1896E-8-2F | 96" | 18" | — | \$1737 | +\$177 |
| | | INCF18104E-8-2F | 104" | 18" | — | \$2014 | +\$204 |
| i | Chimney Power Feed Frame without Electrical For use with 2 ¾" T Frames | INCF1896-8-2F | 96" | 18" | — | \$1691 | +\$172 |
| | | INCF18104-8-2F | 104" | 18" | — | \$1967 | +\$199 |

- City of Chicago bracket for beltline is for 3 ½" thick frame beltline location only
- City of Chicago bracket is compatible with upper deck and base locations in 2 ¾" and 3 ½" thick frames
- "2F" denotes use with 2 ¾" thick frame, "3F" denotes use with 3 ½" thick frame
- Boxes should be sourced through Ental Industries or J&A Sheet both local Chicago suppliers of electrical junction boxes
- Brackets are painted in Eco Black

| | Part number | H | W | List price |
|---|------------------------|---|-----|------------|
|  City of Chicago Brackets (pkg of 6) | INECHB | — | — | \$90 |
| City of Chicago Bracket for Beltline Location For use with 3 ½" T Standard Frames | INECHB-BL-30-3F | — | 30" | \$243 |
| | INECHB-BL-36-3F | — | 36" | \$247 |
| | INECHB-BL-42-3F | — | 42" | \$249 |
| | INECHB-BL-48-3F | — | 48" | \$251 |
| | INECHB-BL-54-3F | — | 54" | \$256 |
| | INECHB-BL-60-3F | — | 60" | \$263 |
| City of Chicago Bracket for Beltline Location For use with 2 ¾" T Standard Frames | INECHB-BL-30-2F | — | 30" | \$243 |
| | INECHB-BL-36-2F | — | 36" | \$247 |
| | INECHB-BL-42-2F | — | 42" | \$249 |
| | INECHB-BL-48-2F | — | 48" | \$251 |
| | INECHB-BL-54-2F | — | 54" | \$256 |
| | INECHB-BL-60-2F | — | 60" | \$263 |

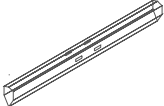
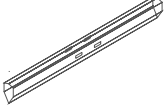

- Add beltline cover kit to a Basic Frame to provide power at beltline location (power track separate)
- Cover kits are painted in Eco Black

| | | Part number | H | W | List price |
|---|---|------------------------|-------|-----|------------|
|  | Beltline Cover Kit For use with 3 1/2" T Frames | INBCVRKIT-18-3F | 6.75" | 18" | \$124 |
| | | INBCVRKIT-24-3F | 6.75" | 24" | \$127 |
| | | INBCVRKIT-30-3F | 6.75" | 30" | \$129 |
| | | INBCVRKIT-36-3F | 6.75" | 36" | \$131 |
| | | INBCVRKIT-42-3F | 6.75" | 42" | \$133 |
| | | INBCVRKIT-48-3F | 6.75" | 48" | \$135 |
| | | INBCVRKIT-54-3F | 6.75" | 54" | \$138 |
| | | INBCVRKIT-60-3F | 6.75" | 60" | \$142 |
|  | Beltline Cover Kit For use with 2 3/4" T Frames | INBCVRKIT-18-2F | 6.75" | 18" | \$124 |
| | | INBCVRKIT-24-2F | 6.75" | 24" | \$127 |
| | | INBCVRKIT-30-2F | 6.75" | 30" | \$129 |
| | | INBCVRKIT-36-2F | 6.75" | 36" | \$131 |
| | | INBCVRKIT-42-2F | 6.75" | 42" | \$133 |
| | | INBCVRKIT-48-2F | 6.75" | 48" | \$135 |
| | | INBCVRKIT-54-2F | 6.75" | 54" | \$138 |
| | | INBCVRKIT-60-2F | 6.75" | 60" | \$142 |

- Specify power tracks for open beltline location in the 3.5" and 2.75" thick standard frames
- Specify Power Track Kit for all locations other than open beltline in 3.5" and 2.75" thick standard frames, where ever a communication or multi access tile is used
- Receptacles and Jumper Cables (track to track connectors) specified separately

NOTES

- Power tracks are required to match the width of the frame it is being installed in
- Power Track Kits may be specified below the following; Transaction Tops, Up mount Bins, Stack on Glaze, Add on Glaze and Double Glazed Tiles
- Power Track Kits **MAY NOT** be specified below Twin Bins or Power Poles

| | | Part number | W | List price |
|---|---|----------------------|-----|------------|
|  | Power Track For use with standard frame at beltline only | INETP30-8 | 30" | \$144 |
| | | INETP36-8 | 36" | \$160 |
| | | INETP42-8 | 42" | \$171 |
| | | INETP48-8 | 48" | \$182 |
| | | INETP54-8 | 54" | \$195 |
| | | INETP60-8 | 60" | \$204 |
|  | Power Track Kit For use in all locations on basic frame | INRUDKIT-30-8 | 30" | \$185 |
| | | INRUDKIT-36-8 | 36" | \$201 |
| | | INRUDKIT-42-8 | 42" | \$219 |
| | | INRUDKIT-48-8 | 48" | \$238 |
| | | INRUDKIT-54-8 | 54" | \$253 |
| | | INRUDKIT-60-8 | 60" | \$273 |
|  | Electrified Twin-Bin Power Track | INETPTWB-8 | 8" | \$88 |

- Jumper Cables do not connect together nor do they attach to power in feeds
- See Inscape System Application Guide for length requirements for varying panel configurations
- 24" and 25" W jumper cables are made of a black flexible mesh material
- 28" W and larger jumper cables are made of a more rigid metal Conduit material

| | Part number | W | List price |
|--|-------------------|------|------------|
|  <p>Jumper Cables</p> | INETC24-8 | 24" | \$72 |
| | INETC25-8 | 25" | \$72 |
| | INETC28-8 | 28" | \$72 |
| | INETC31-8 | 31" | \$74 |
| | INETC44-8 | 44" | \$79 |
| | INETC53-8 | 53" | \$88 |
| | INETC64-8 | 64" | \$104 |
| | INETC88-8 | 88" | \$135 |
| | INETC104-8 | 104" | \$156 |
| | INETC122-8 | 122" | \$192 |
| | INETC141-8 | 141" | \$194 |
| | INETC158-8 | 158" | \$212 |
| | INETC182-8 | 182" | \$243 |







- Receptacles are available in color options of black (default), white and gray
- White close match to 168 Glacier White and Gray close match to 290 – Aluminum Leaf
- Receptacles are specific for frame thickness and location in which they are being specified
- The circuit 3 receptacle requires 2+2 or 3+1 wire designation (“U” in the code signifies 3+1 compatibility)
- The “UD” receptacles are to be specified in conjunction with the Electrified Twin Bin
- Controlled receptacles satisfy California Title 24 and are indicated with a “power mark” which is represented buy a circle with a line

NOTES



In order to get a total cost on products when upcharges are present take the list price of the product number and add the upcharge cost shown to the list price.

For example:

Product IN3D1-8 in Gray would be \$27 +\$11

| | Part number | Black/ base price | White | Gray | |
|--|---|----------------------|-------|-------|-------|
|  | Receptacle for open Beltline | IN3D1-8 | \$27 | +\$11 | +\$11 |
| | For use in 3 1/2" and 2 3/4" frames | IN3D2-8 | \$27 | +\$11 | +\$11 |
| | | IN3D3-8 | \$27 | +\$11 | +\$11 |
| | | IN3D3U-8 | \$27 | +\$11 | +\$11 |
| | | IN3D4-8 | \$27 | +\$11 | +\$11 |
|  | Receptacle for cutout tiles application in 3 1/2" frames | IN3D1-UD-8 | \$27 | +\$11 | +\$11 |
| | | IN3D2-UD-8 | \$27 | +\$11 | +\$11 |
| | | IN3D3-UD-8 | \$27 | +\$11 | +\$11 |
| | | IN3D3U-UD-8 | \$27 | +\$11 | +\$11 |
| | | IN3D4-UD-8 | \$27 | +\$11 | +\$11 |
|  | Receptacle for cutout tiles application in 2 3/4" frames | IN2D1-8 | \$27 | +\$11 | +\$11 |
| | | IN2D2-8 | \$27 | +\$11 | +\$11 |
| | | IN2D3-8 | \$27 | +\$11 | +\$11 |
| | | IN2D3U-8 | \$27 | +\$11 | +\$11 |
| | | IN2D4-8 | \$27 | +\$11 | +\$11 |
|  | Controlled Receptacle for open Beltline | IN3D1-8C | \$32 | +\$11 | +\$11 |
| | For use in 3 1/2" and 2 3/4" frames | IN3D2-8C | \$32 | +\$11 | +\$11 |
| | | IN3D3-8C | \$32 | +\$11 | +\$11 |
| | | IN3D3U-8C | \$32 | +\$11 | +\$11 |
| | | IN3D4-8C | \$32 | +\$11 | +\$11 |
|  | Controlled Receptacle for cutout tiles application in 3 1/2" frames | IN3D1-UD-8C | \$32 | +\$11 | +\$11 |
| | | IN3D2-UD-8C | \$32 | +\$11 | +\$11 |
| | | IN3D3-UD-8C | \$32 | +\$11 | +\$11 |
| | | IN3D3U-UD-8C | \$32 | +\$11 | +\$11 |
| | | IN3D4-UD-8C | \$32 | +\$11 | +\$11 |
|  | Controlled Receptacle for cutout tiles application in 2 3/4" frames | IN2D1-8C | \$32 | +\$11 | +\$11 |
| | | IN2D2-8C | \$32 | +\$11 | +\$11 |
| | | IN2D3-8C | \$32 | +\$11 | +\$11 |
| | | IN2D3U-8C | \$32 | +\$11 | +\$11 |
| | | IN2D4-8C | \$32 | +\$11 | +\$11 |

- USB power modules are available in color options of black (default), white and gray
- White close match to 168 Glacier White and Gray close match to 290 – Aluminum Leaf
- USB power modules are specific for frame thickness and location in which they are being specified
- The circuit 3 USB power modules requires 2+2 or 3+1 wire designation (“U” in the code signifies 3+1 compatibility)
- The “UD” USB power modules are to be specified in conjunction with the Electrified Twin Bin

| | | Part number | List price |
|--|--|----------------------|------------|
|  <p>USB Charging Module</p> | USB outlet For use with 2 ¾” T cut out tile | IN2USB1-8 | \$166 |
| | | IN2USB2-8 | \$166 |
| | | IN2USB3-8 | \$166 |
| | | IN2USB3U-8 | \$166 |
| | | IN2USB4-8 | \$166 |
|  <p>USB Charging Module</p> | USB outlet For use with 3 ½” T cut out tile | IN3USB1-UD-8 | \$168 |
| | | IN3USB2-UD-8 | \$168 |
| | | IN3USB3-UD-8 | \$168 |
| | | IN3USB3U-UD-8 | \$168 |
| | | IN3USB4-UD-8 | \$168 |
|  <p>USB Charging Module</p> | USB outlet For use in open beltline location | IN3USB1-8 | \$164 |
| | | IN3USB2-8 | \$164 |
| | | IN3USB3-8 | \$164 |
| | | IN3USB3U-8 | \$164 |
| | | IN3USB4-8 | \$164 |

- Task Lights mount to the underside of Overhead Bins and Shelves
- Task Lights can be mounted either with screws or magnetically
- A power track must be specified in frame to connect task light
- The LED Magnetic Task Light is magnetic and fits below a Twin Bin and other Overhead Storage
- The Tuck Light is silver with black endcaps and frosted lens

| | | Part number | H | W | Wt (lbs) | List price |
|---|----------------------------------|----------------|------|-----|----------|------------|
|  | LED Magnetic Task Light (silver) | INMAGTL | 7/8" | 20" | 1 | \$416 |

| | | Part number | H | W | D | List price |
|---|------------|----------------|------|-------|-------|------------|
|  | Tuck Light | INTL-17 | 1/2" | 18.6" | 1.18" | \$265 |
| | | INTL-31 | 1/2" | 32.6" | 1.18" | \$299 |
| | | INTL-44 | 1/2" | 45.6" | 1.18" | \$339 |

- The Hinged Cover is a plastic cover that acts as a hinged door to allow access to the cables if needed. Available in color options of black (default), white and gray
- White close match to 168 Glacier White and Gray close match to 290 Aluminum Leaf
- Data hanger bracket is paint Eco Black and allows for industry standard face data plate mount



NOTES

Data cannot be installed directly back to back in a 2 ¾" thick frame application







In order to get a total cost on products when upcharges are present take the list price of the product number and add the upcharge cost shown to the list price.

For example:

Product INHRC in Gray would be \$22 +\$11

| | Part number | Wt (lbs) | Black/ base price | White | Gray |
|---|-----------------|----------|----------------------|-------|-------|
|  <p>Data Outlet Hanger Brackets (pair)</p> | INDPMT-W | 2 | \$49 | — | — |
|  <p>Hinged Cover for Tiles with Cutouts</p> | INHRC | — | \$22 | +\$11 | +\$11 |

- Grommets must be field installed
- Round Grommet = 2" diameter
- Rectangular Grommet = 3" x 5.25"
- Power Modules mount to the back edge of a surface and are accessible by the user above the surface
- Power Modules plug into the duplexes
- The Clamp-On Power Module is available in a black or white finish. It has a 96" long power cord and LED surge protection indication. It attaches to 1" and 1 ¼" thick worksurfaces and the mount includes a device holder.
- The Clamp-On Power Module with Colored Components comes in many different configurations with receptacles, USB (1 type A and 1 type B) ports and availability lights. Power Modules come in black, white or gray and have colored options for the lid; Black, White, Teal, Red, Purple, Blue, Green, Gray. The availability light is user controlled and requires free software download.
- Flip-up Power & Data Module is finished with a clear anodized aluminum with white inserts and a 72" long power cord
- All electrical components on this page are field installed









| | Part number | Dimensions | Black/ base price | White | Silver | Stainless steel |
|---|-----------------------|------------|----------------------|-------|--------|--------------------|
|  <p>Grommet Sleeve & Cover Kit</p> | PLNGRKIT | 5 ¼" | \$208 | — | — | +\$85 |
|  <p>Worksurface Grommet-PVC Sleeve & CAP</p> | GROMMET-WS | — | \$18 | — | — | — |
| | Part number | | | | | List price |
|  <p>Clamp-On Power Module 3 receptacles/1 dual USB port</p> | INPMOD-3P1U | | | | | \$173 |
|  <p>Clamp-On Power Module with Colored Components 2 Ports: 1 receptacle + 1 USB AC</p> | INBPMOD-1P1U | | | | | \$437 |
|  <p>Clamp-On Power Module with Colored Components 4 Ports: 2 receptacles + 1 USB AC + 1 open data port data not provided</p> | INBPMOD-2P1U1O | | | | | \$548 |
|  <p>Clamp-On Power Module with Colored Components 4 Ports: 2 receptacles + 1 USB AC + 1 availability light</p> | INBPMOD-2P1U1L | | | | | \$867 |

Technology

Clamp On Power & Data Modules

System

- One cable hook is included with each standard frame
- Wire Casing (INFWC) is 29" long and allows for electrical and data cables to be brought neatly from floor into a table – available in gray only, works with 28.5" worksurface heights
- Power bar available in black only
- Cable Management Tray (INCMTXX) is available in two lengths, painted Eco Black and includes mounting hardware
- Wire Management clips are white and attach by double sided tape which is included

| | | Part number | W | Wt (lbs) | List price |
|---|---|--------------------|-----|----------|------------|
|  | Flip-up Power & Data Module 2 outlets + 1 dual USB + 1 data finished in aluminium with white insert | PVDMODFL | | | \$902 |
|  | Extension Cord for Recessed Duplexes | INEXTCORD-1 | 12" | — | \$72 |
|  | Cable Hooks | INEPWMH | — | 0.1 | \$18 |
|  | Wire Management Clip (pkg of 10) | INWMCLIP | — | — | \$30 |
|  | Wire Casing (Gray color) | INFWC | — | — | \$130 |
|  | Power Bar (6 outlets, 10' cord) | INPBAR | — | — | \$53 |
|  | Cable Management Tray | INCMT18 | 18" | — | \$36 |
| | | INCMT30 | 30" | — | \$47 |
|  | Wire mesh cable tray (silver) | INWMTRAY | — | — | \$133 |

System
Worksurfaces
& Supports

inscape

work for tomorrow

Worksurfaces & Supports

Panel Mounted Worksurfaces
General Information

System

Depth dimension is nominal. Depths are 1" less than stated to provide a 1" gap between the worksurface and panel to facilitate wire management.

True sized worksurfaces are actual size for both the depth and the width.

IMPERIAL TO METRIC CONVERSIONS

| Inches | mm |
|--------|------|
| 18" | 457 |
| 24" | 610 |
| 30" | 762 |
| 36" | 914 |
| 42" | 1067 |
| 48" | 1219 |
| 54" | 1372 |
| 60" | 1524 |
| 66" | 1676 |
| 72" | 1829 |
| 78" | 1981 |
| 84" | 2134 |
| 90" | 2286 |
| 96" | 2438 |

ELECTRIFIED STORAGE WORKSURFACES

Electrified storage worksurface lengths are true size to what is printed in the price list and are 1" less in length than a module line (panel). This allows for a 1" gap between the Electrified Storage unit and the end of the worksurface facilitating wire management and space for the Electrified Storage worksurface support bracket. This 1" less in length also allows the worksurface to line up on-module with a panel. Optional pencil groove is available.

NUFORM CLASSIC AND NUFORM SELECT WORKSURFACES

The Nuform top is a thermo-formable polymer based sheet continuously bonded to a 1/4" or 1" thick MDF substrate. The polymer sheet is surface coated with a scratch resistant film. Colors are homogenous throughout the film thickness. Top and edge are one continuous surface with no edge seams. The underside of the top is finished in a low pressure melamine. Nuform tops have the option of a pencil groove running across the width of the worksurface as standard and depth for conference tables. Two price options are available - Nuform Classic and Nuform Select.

Limitations exist with the F09, F38, F40, F42, F43, F45, F46, F47, F48, F49, F50, F51, F57, F58 & F59 Nuforms due to the directional pattern. 48"w standard and split corners are not possible for the above referenced Nuform.

EDGE DETAILED - NUFORM CLASSIC & NUFORM SELECT

1 1/4" Straight Edge



1" Straight Edge



1 1/4" Tapered Edge

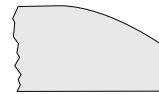

1" Tapered Edge



Top and edge are one continuous surface with no edge seams.

LAMINATE WORKSURFACES

Plastic laminate is laminated to 1.25" thick particle-board. The underside of the worksurface is finished with a man-made, wood-fiber veneer backer. Worksurfaces specified with a plastic laminate finish include a 2mm edge banding in a coordinating color. Plastic laminate tops do not include a pencil groove.

All worksurfaces default to 1.25" thick, Straight edge. Pencil Groove is only available on Nuform.

EDGE DETAIL - LAMINATE

Straight Edge



Load capacity for freestanding and panel mounted worksurfaces is 4.5lbs per linear inch.

Worksurfaces & Supports

Panel Mounted Worksurfaces
General Information

System

GRAIN DIRECTION

Grain direction on woodgrain Nuform worksurfaces is as denoted below.

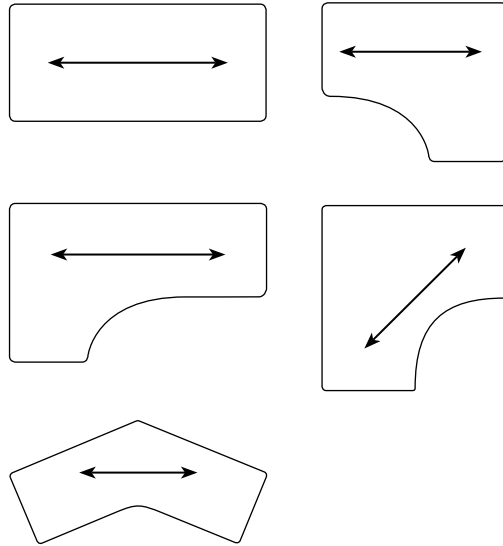

ADJUSTABLE HEIGHT WORKSURFACES

Adjustable height worksurfaces are available in a panel mounted version which mounts on-module to the Inscape System frame. Worksurfaces provide gas cylinder height adjustment ranging from 28.5" to 49.5" with a lift capacity and calibration of a recommended 25lbs (not including the worksurface). Worksurfaces structured on the height adjustable mechanism are 1" less in stated width in the price list, and are meant to be installed on center to the base allowing for a gap between adjacent surfaces to eliminate pinch points. The base mechanism of the worksurface is available in gray only. See the Inscape System Application Guide for application notes and restrictions.

Worksurfaces & Supports

Panel Mounted Worksurfaces

Rectangular Tops

System

PRODUCT CODE KEY EXAMPLE

INW2024

| | |
|------------|-------------------------------|
| INW | Inscape System worksurface |
| 20 | 20" D |
| 18 | 24" W |

- Depth dimension is nominal. Depths are 1" less than stated to provide a 1" gap between the worksurface and panel to facilitate wire management.
- When manually specifying worksurface in laminate, add suffix "-S" to the code
- Optional pencil groove with Nuform
- To manually specify Nuform worksurfaces; begin with the desired thickness then build up options
- 20" deep tops should not be specified with cantilever brackets as mid span support
- 1" thick worksurfaces are not available in laminate
- Stretcher bars are required to be specified with worksurfaces 54" and wider which do have any mid support- ensure not to interfere with support brackets, cable trays or other work tools



NOTES

In order to get a total cost on products when an upcharge or downcharge is present you take the list price of the product number and add the upcharge or deduct the downcharge cost shown to the list price.

For example:

Product INW2024 in Nuform Select with a tapered edge would be \$237 +\$29 +\$17

Product INW2024 in Nuform Select with a 1" straight edge would be \$237 +\$29 -\$27

| | Part number | W | D | 1 1/4" straight edge Nuform classic/ laminate/base price | Nuform select | Nuform tapered edge | Nuform 1" straight edge | Grade 1 laminate 1 1/4" straight edge only |
|--|----------------|-----|-------|--|------------------|------------------------|----------------------------|--|
|  <p>20" D Rectangular Top</p> | INW2024 | 24" | 20" | \$237 | +\$29 | +\$17 | -\$27 | +\$77 |
| | INW2030 | 30" | 20" | \$255 | +\$31 | +\$20 | -\$30 | +\$85 |
| | INW2036 | 36" | 20" | \$289 | +\$33 | +\$20 | -\$32 | +\$94 |
| | INW2042 | 42" | 20" | \$304 | +\$33 | +\$21 | -\$32 | +\$99 |
| | INW2048 | 48" | 20" | \$347 | +\$37 | +\$23 | -\$36 | +\$112 |
| | INW2054 | 54" | 20" | \$388 | +\$47 | +\$29 | -\$39 | +\$126 |
| | INW2060 | 60" | 20" | \$432 | +\$51 | +\$31 | -\$46 | +\$140 |
| | INW2066 | 66" | 20" | \$474 | +\$53 | +\$33 | -\$50 | +\$153 |
| | INW2072 | 72" | 20" | \$518 | +\$59 | +\$34 | -\$52 | +\$168 |
| | INW2078 | 78" | 20" | \$562 | +\$64 | +\$36 | -\$58 | +\$181 |
| | INW2084 | 84" | 20" | \$692 | +\$71 | +\$37 | -\$127 | +\$222 |
| | INW2090 | 90" | 20" | \$734 | +\$77 | +\$44 | -\$108 | +\$237 |
| INW2096 | 96" | 20" | \$781 | +\$87 | +\$46 | -\$102 | +\$251 | |
|  <p>24" D Rectangular Top</p> | INW2424 | 24" | 24" | \$292 | +\$33 | +\$17 | -\$32 | +\$96 |
| | INW2430 | 30" | 24" | \$318 | +\$35 | +\$20 | -\$34 | +\$103 |
| | INW2436 | 36" | 24" | \$360 | +\$39 | +\$20 | -\$37 | +\$118 |
| | INW2442 | 42" | 24" | \$377 | +\$42 | +\$21 | -\$39 | +\$123 |
| | INW2448 | 48" | 24" | \$432 | +\$47 | +\$23 | -\$46 | +\$140 |
| | INW2454 | 54" | 24" | \$485 | +\$53 | +\$29 | -\$52 | +\$158 |
| | INW2460 | 60" | 24" | \$538 | +\$57 | +\$31 | -\$56 | +\$173 |
| | INW2466 | 66" | 24" | \$590 | +\$61 | +\$33 | -\$60 | +\$191 |
| | INW2472 | 72" | 24" | \$646 | +\$67 | +\$34 | -\$66 | +\$209 |
| | INW2478 | 78" | 24" | \$701 | +\$73 | +\$36 | -\$72 | +\$226 |
| | INW2484 | 84" | 24" | \$755 | +\$79 | +\$37 | -\$77 | +\$243 |
| | INW2490 | 90" | 24" | \$812 | +\$87 | +\$44 | -\$86 | +\$262 |
| INW2496 | 96" | 24" | \$867 | +\$90 | +\$46 | -\$89 | +\$279 | |

Worksurfaces & Supports

Panel Mounted Worksurfaces
Rectangular Tops

System

PRODUCT CODE KEY EXAMPLE

INW2024

| | |
|------------|-------------------------------|
| INW | Inscape System worksurface |
| 20 | 20" D |
| 18 | 24" W |

- Depth dimension is nominal. Depths are 1" less than stated to provide a 1" gap between the worksurface and panel to facilitate wire management.
- When manually specifying worksurface in laminate, add suffix "-S" to the code
- Optional pencil groove with Nuform
- To manually specify Nuform worksurfaces; begin with the desired thickness then build up options
- 1" thick worksurfaces are not available in laminate
- Stretcher bars are required to be specified with worksurfaces 54" and wider which do have any mid support- ensure not to interfere with support brackets, cable trays or other work tools



NOTES

In order to get a total cost on products when an upcharge or downcharge is present you take the list price of the product number and add the upcharge or deduct the downcharge cost shown to the list price.

For example:

Product INW3024 in Nuform Select with a tapered edge would be \$373 +\$42 +\$21

Product INW3024 in Nuform Select with a 1" straight edge would be \$373 +\$42 -\$39

| | Part number | W | D | 1 1/4" straight edge Nuform classic/ laminate/base price | Nuform select | Nuform tapered edge | Nuform 1" straight edge | Grade 1 laminate 1 1/4" straight edge only |
|--|----------------|-----|--------|--|------------------|------------------------|----------------------------|--|
|  <p>30" D Rectangular Top</p> | INW3024 | 24" | 30" | \$373 | +\$42 | +\$21 | -\$39 | +\$121 |
| | INW3030 | 30" | 30" | \$393 | +\$45 | +\$25 | -\$44 | +\$128 |
| | INW3036 | 36" | 30" | \$448 | +\$48 | +\$26 | -\$47 | +\$144 |
| | INW3042 | 42" | 30" | \$472 | +\$51 | +\$27 | -\$50 | +\$153 |
| | INW3048 | 48" | 30" | \$538 | +\$57 | +\$31 | -\$56 | +\$173 |
| | INW3054 | 54" | 30" | \$604 | +\$63 | +\$32 | -\$61 | +\$196 |
| | INW3060 | 60" | 30" | \$674 | +\$70 | +\$35 | -\$69 | +\$216 |
| | INW3066 | 66" | 30" | \$720 | +\$74 | +\$39 | -\$73 | +\$233 |
| | INW3072 | 72" | 30" | \$807 | +\$85 | +\$42 | -\$84 | +\$259 |
| | INW3078 | 78" | 30" | \$895 | +\$91 | +\$47 | -\$90 | +\$288 |
| | INW3084 | 84" | 30" | \$980 | +\$102 | +\$52 | -\$100 | +\$316 |
| INW3090 | 90" | 30" | \$1066 | +\$111 | +\$57 | -\$106 | +\$343 | |
| INW3096 | 96" | 30" | \$1156 | +\$120 | +\$60 | -\$118 | +\$371 | |
|  <p>36" D Rectangular Top</p> | INW3624 | 24" | 36" | \$431 | +\$48 | +\$67 | -\$48 | +\$139 |
| | INW3630 | 30" | 36" | \$456 | +\$51 | +\$72 | -\$51 | +\$147 |
| | INW3636 | 36" | 36" | \$519 | +\$56 | +\$83 | -\$56 | +\$168 |
| | INW3642 | 42" | 36" | \$548 | +\$57 | +\$86 | -\$57 | +\$177 |
| | INW3648 | 48" | 36" | \$621 | +\$66 | +\$97 | -\$70 | +\$201 |
| | INW3654 | 54" | 36" | \$699 | +\$73 | +\$105 | -\$70 | +\$225 |
| | INW3660 | 60" | 36" | \$783 | +\$84 | +\$118 | -\$84 | +\$252 |
| | INW3666 | 66" | 36" | \$830 | +\$87 | +\$124 | -\$87 | +\$267 |
| | INW3672 | 72" | 36" | \$935 | +\$94 | +\$129 | -\$93 | +\$301 |

Worksurfaces & Supports

Panel Mounted Worksurfaces
90° Rectangular Tops

System

PRODUCT CODE KEY EXAMPLE

INSWW2423

| | |
|------------|-----------------|
| IN | Inscape System |
| SWW | 90° worksurface |
| 24 | 24" D |
| 23 | 23" W |

- 90° worksurfaces are 1" less in length than standard worksurfaces to accommodate a wire management gap all the way around an L shaped workstation
- When manually specifying worksurface in laminate, add suffix "-S" to the code
- Optional pencil groove with Nuform
- To manually specify Nuform worksurfaces; begin with the desired thickness then build up options
- 1" thick worksurfaces are not available in laminate
- Stretcher bars are required to be specified with worksurfaces 54" and wider which do have any mid support – ensure not to interfere with support brackets, cable trays or other work tools



NOTES

In order to get a total cost on products when an upcharge or downcharge is present you take the list price of the product number and add the upcharge or deduct the downcharge cost shown to the list price.

For example:

Product INSWW2423 in Nuform Select with a tapered edge would be \$292 +\$33 +\$17

Product INSWW2423 in Nuform Select with a 1" straight edge would be \$292 +\$33 -\$32

| | Part number | W | D | 1 1/4" straight edge Nuform classic/ laminate/base price | Nuform select | Nuform tapered edge | Nuform 1" straight edge | Grade 1 laminate 1 1/4" straight edge only |
|--|------------------|-----|--------|--|------------------|------------------------|----------------------------|--|
|  <p>24" D 90° Rectangular Top</p> | INSWW2423 | 23" | 24" | \$292 | +\$33 | +\$17 | -\$32 | +\$96 |
| | INSWW2429 | 29" | 24" | \$318 | +\$35 | +\$20 | -\$34 | +\$103 |
| | INSWW2435 | 35" | 24" | \$360 | +\$39 | +\$20 | -\$37 | +\$118 |
| | INSWW2441 | 41" | 24" | \$377 | +\$42 | +\$21 | -\$39 | +\$123 |
| | INSWW2447 | 47" | 24" | \$432 | +\$47 | +\$23 | -\$46 | +\$140 |
| | INSWW2453 | 53" | 24" | \$485 | +\$53 | +\$29 | -\$52 | +\$158 |
| | INSWW2459 | 59" | 24" | \$538 | +\$57 | +\$31 | -\$56 | +\$173 |
| | INSWW2465 | 65" | 24" | \$590 | +\$61 | +\$33 | -\$60 | +\$191 |
| | INSWW2471 | 71" | 24" | \$646 | +\$67 | +\$34 | -\$66 | +\$209 |
| | INSWW2477 | 77" | 24" | \$701 | +\$73 | +\$36 | -\$72 | +\$226 |
| | INSWW2483 | 83" | 24" | \$755 | +\$79 | +\$37 | -\$77 | +\$243 |
| | INSWW2489 | 89" | 24" | \$812 | +\$87 | +\$44 | -\$86 | +\$262 |
| INSWW2495 | 95" | 24" | \$867 | +\$90 | +\$46 | -\$89 | +\$279 | |
|  <p>30" D 90° Rectangular Top</p> | INSWW3023 | 23" | 30" | \$373 | +\$42 | +\$21 | -\$39 | +\$121 |
| | INSWW3029 | 29" | 30" | \$393 | +\$45 | +\$25 | -\$44 | +\$128 |
| | INSWW3035 | 35" | 30" | \$448 | +\$48 | +\$26 | -\$47 | +\$144 |
| | INSWW3041 | 41" | 30" | \$472 | +\$51 | +\$27 | -\$50 | +\$153 |
| | INSWW3047 | 47" | 30" | \$538 | +\$57 | +\$31 | -\$56 | +\$173 |
| | INSWW3053 | 53" | 30" | \$604 | +\$63 | +\$32 | -\$61 | +\$196 |
| | INSWW3059 | 59" | 30" | \$674 | +\$70 | +\$35 | -\$69 | +\$216 |
| | INSWW3065 | 65" | 30" | \$720 | +\$74 | +\$39 | -\$73 | +\$233 |
| | INSWW3071 | 71" | 30" | \$807 | +\$85 | +\$42 | -\$84 | +\$259 |
| | INSWW3077 | 77" | 30" | \$895 | +\$91 | +\$47 | -\$90 | +\$288 |
| | INSWW3083 | 83" | 30" | \$980 | +\$102 | +\$52 | -\$100 | +\$316 |
| | INSWW3089 | 89" | 30" | \$1066 | +\$111 | +\$57 | -\$106 | +\$343 |
| INSWW3095 | 95" | 30" | \$1156 | +\$120 | +\$60 | -\$118 | +\$371 | |
|  <p>36" D 90° Rectangular Top</p> | INSWW3623 | 23" | 36" | \$431 | +\$48 | +\$67 | -\$48 | +\$139 |
| | INSWW3629 | 29" | 36" | \$456 | +\$51 | +\$72 | -\$51 | +\$147 |
| | INSWW3635 | 35" | 36" | \$519 | +\$56 | +\$83 | -\$56 | +\$168 |
| | INSWW3641 | 41" | 36" | \$548 | +\$57 | +\$86 | -\$57 | +\$177 |
| | INSWW3647 | 47" | 36" | \$621 | +\$66 | +\$97 | -\$70 | +\$201 |
| | INSWW3653 | 53" | 36" | \$699 | +\$73 | +\$105 | -\$73 | +\$225 |
| | INSWW3659 | 59" | 36" | \$783 | +\$84 | +\$118 | -\$84 | +\$252 |
| | INSWW3665 | 65" | 36" | \$830 | +\$87 | +\$124 | -\$87 | +\$267 |
| | INSWW3671 | 71" | 36" | \$935 | +\$94 | +\$129 | -\$93 | +\$301 |

Worksurfaces & Supports

Panel Mounted Worksurfaces
True Sized Rectangular Tops

System

PRODUCT CODE KEY EXAMPLE

INSTW1830

INSTW Inscape System
worksurface

18 18" D

30 30" W

- These worksurfaces are true sized for both depth & width
- When manually specifying worksurface in laminate, add suffix “-S” to the code
- To manually specify Nuform worksurfaces; begin with the desired thickness then build up options
- 18" deep tops should not be specified with cantilever brackets as mid span support
- 1" thick worksurfaces are not available in laminate
- Stretcher bars are required to be specified with worksurfaces 54" and wider which do have any mid support – ensure not to interfere with support brackets, cable trays or other work tools



NOTES

In order to get a total cost on products when an upcharge or downcharge is present you take the list price of the product number and add the upcharge or deduct the downcharge cost shown to the list price.

For example:

Product INSTW1830 in Nuform Select would be \$222 +\$27

Product INSTW1830 in Nuform Select with a 1" straight edge would be \$222 +\$27 -\$25

| | Part number | W | D | 1 1/4" straight edge Nuform classic/laminate/base price | Nuform select | Nuform 1" straight edge | Grade 1 laminate 1 1/4" straight edge only |
|---|------------------|-----|-----|---|---------------|-------------------------|--|
|  <p>18" D True Sized Rectangular Top</p> | INSTW1830 | 30" | 18" | \$222 | +\$27 | -\$25 | +\$72 |
| | INSTW1836 | 36" | 18" | \$248 | +\$31 | -\$29 | +\$80 |
| | INSTW1842 | 42" | 18" | \$276 | +\$34 | -\$32 | +\$89 |
| | INSTW1848 | 48" | 18" | \$302 | +\$37 | -\$34 | +\$98 |
| | INSTW1854 | 54" | 18" | \$329 | +\$40 | -\$37 | +\$106 |
| | INSTW1860 | 60" | 18" | \$400 | +\$49 | -\$45 | +\$129 |
| | INSTW1866 | 66" | 18" | \$417 | +\$51 | -\$47 | +\$134 |
| | INSTW1872 | 72" | 18" | \$467 | +\$57 | -\$52 | +\$151 |
|  <p>24" D True Sized Rectangular Top</p> | INSTW2430 | 30" | 24" | \$318 | +\$36 | -\$35 | +\$103 |
| | INSTW2436 | 36" | 24" | \$360 | +\$39 | -\$37 | +\$116 |
| | INSTW2442 | 42" | 24" | \$377 | +\$42 | -\$40 | +\$121 |
| | INSTW2448 | 48" | 24" | \$432 | +\$47 | -\$46 | +\$139 |
| | INSTW2454 | 54" | 24" | \$485 | +\$53 | -\$53 | +\$156 |
| | INSTW2460 | 60" | 24" | \$538 | +\$57 | -\$56 | +\$173 |
| | INSTW2466 | 66" | 24" | \$590 | +\$61 | -\$61 | +\$189 |
| | INSTW2472 | 72" | 24" | \$646 | +\$67 | -\$66 | +\$208 |

Worksurfaces & Supports

Panel Mounted Worksurfaces

Reducing Tops

System

PRODUCT CODE KEY EXAMPLE

INRDL302430

| | |
|-------------|----------------|
| IN | Inscape System |
| RD | reducing top |
| L | left hand |
| 3024 | 30 – 24" D |
| 30 | 30" W |

- Depth dimension is nominal. Depths are 1" less than stated to provide a 1" gap between the worksurface and panel to facilitate wire management.
- Reducing tops are available in Nuform finish only
- Optional pencil groove with Nuform
- To manually specify Nuform worksurfaces; begin with the desired thickness then build up options
- 1" thick worksurfaces are not available in laminate
- Stretcher bars are required to be specified with worksurfaces 54" and wider which do have any mid support– ensure not to interfere with support brackets, cable trays or other work tools



NOTES

In order to get a total cost on products when an upcharge or downcharge is present you take the list price of the product number and add the upcharge or deduct the downcharge cost shown to the list price.

For example:

Product INRDL302430 in Nuform Select with a tapered edge would be \$391 +\$37 +\$22

Product INRDL302430 in Nuform Select with a 1" straight edge would be \$391 +\$37 -\$36

| | Part number | W | D | 1 1/4" straight edge Nuform classic/ laminate/base price | Nuform select | Nuform tapered edge | Nuform 1" straight edge |
|--|--------------------|--------|--------|--|------------------|------------------------|----------------------------|
|  Left Hand Reducing Top | INRDL302430 | 30" | 30-24" | \$391 | +\$37 | +\$22 | -\$36 |
| | INRDL302436 | 36" | 30-24" | \$448 | +\$46 | +\$25 | -\$45 |
| | INRDL302442 | 42" | 30-24" | \$472 | +\$47 | +\$26 | -\$46 |
| | INRDL302448 | 48" | 30-24" | \$538 | +\$52 | +\$30 | -\$51 |
| | INRDL302454 | 54" | 30-24" | \$604 | +\$57 | +\$32 | -\$56 |
| | INRDL302460 | 60" | 30-24" | \$674 | +\$63 | +\$35 | -\$61 |
| | INRDL302466 | 66" | 30-24" | \$720 | +\$67 | +\$37 | -\$66 |
| | INRDL302472 | 72" | 30-24" | \$803 | +\$74 | +\$43 | -\$73 |
| | INRDL302478 | 78" | 30-24" | \$844 | +\$79 | +\$44 | -\$74 |
| | INRDL302484 | 84" | 30-24" | \$884 | +\$87 | +\$46 | -\$86 |
| | INRDL302490 | 90" | 30-24" | \$923 | +\$86 | +\$52 | -\$86 |
| INRDL302496 | 96" | 30-24" | \$974 | +\$94 | +\$53 | -\$93 | |
|  Right Hand Reducing Top | INRDR243030 | 30" | 24-30" | \$391 | +\$37 | +\$22 | -\$36 |
| | INRDR243036 | 36" | 24-30" | \$448 | +\$46 | +\$25 | -\$45 |
| | INRDR243042 | 42" | 24-30" | \$472 | +\$47 | +\$26 | -\$46 |
| | INRDR243048 | 48" | 24-30" | \$538 | +\$52 | +\$30 | -\$51 |
| | INRDR243054 | 54" | 24-30" | \$604 | +\$57 | +\$32 | -\$56 |
| | INRDR243060 | 60" | 24-30" | \$674 | +\$63 | +\$35 | -\$61 |
| | INRDR243066 | 66" | 24-30" | \$720 | +\$67 | +\$37 | -\$66 |
| | INRDR243072 | 72" | 24-30" | \$803 | +\$74 | +\$43 | -\$73 |
| | INRDR243078 | 78" | 24-30" | \$844 | +\$79 | +\$44 | -\$74 |
| | INRDR243084 | 84" | 24-30" | \$884 | +\$87 | +\$46 | -\$86 |
| | INRDR243090 | 90" | 24-30" | \$923 | +\$86 | +\$52 | -\$86 |
| INRDR243096 | 96" | 24-30" | \$974 | +\$94 | +\$53 | -\$93 | |

Worksurfaces & Supports

Panel Mounted Worksurfaces
Saddle Tops

System

PRODUCT CODE KEY EXAMPLE

INSD3048

| | |
|-----------|-------------------------------|
| IN | Inscape System worksurface |
| SD | saddle top |
| 30 | 30" D |
| 48 | 48" W |

- Depth dimension is nominal. Depths are 1" less than stated to provide a 1" gap between the worksurface and panel to facilitate wire management.
- When manually specifying worksurface in laminate, add suffix "-S" to the code
- Optional pencil groove with Nuform
- To manually specify Nuform worksurfaces; begin with the desired thickness then build up options
- 1" thick worksurfaces are not available in laminate
- Stretcher bars are required to be specified with worksurfaces 54" and wider which do have any mid support- ensure not to interfere with support brackets, cable trays or other work tools

NOTES

In order to get a total cost on products when an upcharge or downcharge is present you take the list price of the product number and add the upcharge or deduct the downcharge cost shown to the list price.

For example:

Product INSD3048 in Nuform Select with a tapered edge would be \$565 +\$59 +\$32

Product INSD3048 in Nuform Select with a 1" straight edge would be \$565 +\$59 -\$58

| | Part number | W | D | 1 1/4" straight edge Nuform classic/ laminate/base price | Nuform select | Nuform tapered edge | Nuform 1" straight edge | Grade 1 laminate 1 1/4" straight edge only |
|---|-----------------|-----|-----|--|------------------|------------------------|----------------------------|--|
|  <p>30" D Saddle Top</p> | INSD3048 | 48" | 30" | \$565 | +\$59 | +\$32 | -\$58 | +\$182 |
| | INSD3054 | 54" | 30" | \$634 | +\$66 | +\$33 | -\$64 | +\$205 |
| | INSD3060 | 60" | 30" | \$708 | +\$74 | +\$36 | -\$73 | +\$228 |
| | INSD3066 | 66" | 30" | \$753 | +\$77 | +\$42 | -\$76 | +\$242 |
| | INSD3072 | 72" | 30" | \$847 | +\$88 | +\$44 | -\$87 | +\$274 |
| | INSD3084 | 84" | 30" | \$1017 | +\$106 | +\$54 | -\$93 | +\$327 |
| | INSD3096 | 96" | 30" | \$1199 | +\$126 | +\$64 | -\$106 | +\$386 |

Worksurfaces & Supports

Panel Mounted Worksurfaces

90° Saddle Tops

System

PRODUCT CODE KEY EXAMPLE

INSWSD3047

| | |
|-------------|-----------------|
| IN | Inscape System |
| SWSD | 90° worksurface |
| 24 | 30" D |
| 23 | 47" W |

- 90° worksurfaces are 1" less in length than standard worksurfaces to accommodate a wire management gap all the way around an L shaped workstation
- When manually specifying worksurface in laminate, add suffix "-S" to the code
- Optional pencil groove with Nuform
- To manually specify Nuform worksurfaces; begin with the desired thickness then build up options
- 1" thick worksurfaces are not available in laminate
- Stretcher bars are required to be specified with worksurfaces 54" and wider which do have any mid support – ensure not to interfere with support brackets, cable trays or other work tools



NOTES

In order to get a total cost on products when an upcharge or downcharge is present you take the list price of the product number and add the upcharge or deduct the downcharge cost shown to the list price.

For example:

Product INSWSD3047 in Nuform Select with a tapered edge would be \$565 +\$59 +\$32

Product INSWSD3047 in Nuform Select with a 1" straight edge would be \$565 +\$59 -\$58

| | Part number | W | D | 1 1/4" straight edge Nuform classic/ laminate/base price | Nuform select | Nuform tapered edge | Nuform 1" straight edge | Grade 1 laminate 1 1/4" straight edge only |
|---|-------------------|-----|-----|--|------------------|------------------------|----------------------------|--|
|  30"D 90° Saddle Top | INSWSD3047 | 47" | 30" | \$565 | +\$59 | +\$32 | -\$58 | +\$182 |
| | INSWSD3053 | 53" | 30" | \$634 | +\$66 | +\$33 | -\$64 | +\$205 |
| | INSWSD3059 | 59" | 30" | \$708 | +\$74 | +\$36 | -\$73 | +\$228 |
| | INSWSD3065 | 65" | 30" | \$753 | +\$77 | +\$42 | -\$76 | +\$242 |
| | INSWSD3071 | 71" | 30" | \$847 | +\$88 | +\$44 | -\$87 | +\$274 |
|  36"D 90° Saddle Top | INSWSD3647 | 47" | 36" | \$646 | +\$64 | +\$33 | -\$70 | +\$209 |
| | INSWSD3653 | 53" | 36" | \$723 | +\$74 | +\$37 | -\$73 | +\$234 |
| | INSWSD3659 | 59" | 36" | \$807 | +\$87 | +\$43 | -\$86 | +\$259 |
| | INSWSD3665 | 65" | 36" | \$860 | +\$89 | +\$46 | -\$88 | +\$277 |
| | INSWSD3671 | 71" | 36" | \$966 | +\$98 | +\$50 | -\$97 | +\$312 |

Worksurfaces & Supports

Panel Mounted Worksurfaces
Galley Tops

System

PRODUCT CODE KEY EXAMPLE

INWG362460

| | |
|-------------|-------------------------------|
| INW | Inscape System worksurface |
| G | galley top |
| 3624 | 36 – 24" D |
| 4608 | 60" W |

- Depth dimension is nominal. Depths are 1" less than stated to provide a 1" gap between the worksurface and panel to facilitate wire management.
- When manually specifying worksurface in laminate, add suffix "-S" to the code
- Optional pencil groove with Nuform
- To manually specify Nuform worksurfaces; begin with the desired thickness then build up options
- 1" thick worksurfaces are not available in laminate
- Stretcher bars are required to be specified with worksurfaces 54" and wider which do have any mid support– ensure not to interfere with support brackets, cable trays or other work tools



NOTES

In order to get a total cost on products when an upcharge or downcharge is present you take the list price of the product number and add the upcharge or deduct the downcharge cost shown to the list price.

For example:

Product INWG362460 in Nuform Select with a tapered edge would be \$783 +\$84 +\$37

Product INWG362460 in Nuform Select with a 1" straight edge would be \$783 +\$84 -\$76

| | Part number | W | D | 1 1/4" straight edge Nuform classic/ laminate/base price | Nuform select | Nuform tapered edge | Nuform 1" straight edge | Grade 1 laminate 1 1/4" straight edge only |
|--|-------------------|-----|--------|--|------------------|------------------------|----------------------------|--|
|  Left Hand Galley Top | INWG362460 | 60" | 36-24" | \$783 | +\$84 | +\$37 | -\$76 | +\$252 |
| | INWG362466 | 66" | 36-24" | \$841 | +\$88 | +\$43 | -\$87 | +\$272 |
| | INWG362472 | 72" | 36-24" | \$935 | +\$96 | +\$48 | -\$94 | +\$301 |
| | INWG362478 | 78" | 36-24" | \$1035 | +\$105 | +\$54 | -\$103 | +\$332 |
| | INWG362484 | 84" | 36-24" | \$1137 | +\$119 | +\$59 | -\$116 | +\$366 |
| | INWG362490 | 90" | 36-24" | \$1170 | +\$120 | +\$64 | -\$118 | +\$376 |
| | INWG362496 | 96" | 36-24" | \$1228 | +\$126 | +\$69 | -\$124 | +\$395 |
|  Right Hand Galley Top | INWG243660 | 60" | 24-36" | \$783 | +\$84 | +\$37 | -\$76 | +\$252 |
| | INWG243666 | 66" | 24-36" | \$841 | +\$88 | +\$43 | -\$87 | +\$272 |
| | INWG243672 | 72" | 24-36" | \$935 | +\$96 | +\$48 | -\$94 | +\$301 |
| | INWG243678 | 78" | 24-36" | \$1035 | +\$105 | +\$54 | -\$103 | +\$332 |
| | INWG243684 | 84" | 24-36" | \$1137 | +\$119 | +\$59 | -\$116 | +\$366 |
| | INWG243690 | 90" | 24-36" | \$1170 | +\$120 | +\$64 | -\$118 | +\$376 |
| | INWG243696 | 96" | 24-36" | \$1228 | +\$126 | +\$69 | -\$124 | +\$395 |

Worksurfaces & Supports

Panel Mounted Worksurfaces
Standard Corners

System

PRODUCT CODE KEY EXAMPLE

INCR3636-22

INCR Inscape System
standard corner

3636 36x 36" W

24 24" D

- Depth dimension is nominal. Depths are 1" less than stated to provide a 1" gap between the worksurface and panel to facilitate wire management.
- When manually specifying worksurface in laminate, add suffix "-S" to the code
- Optional pencil groove with Nuform
- To manually specify Nuform worksurfaces; begin with the desired thickness then build up options
- 48" Split Corner accommodates 24" or 30" returns
- Standard Corner and Split Corner include a radius front edge
- Limitations exist with the F09, F38, F40, F42, F43, F45, F46, F47, F48, F49, F50, F51, F57, F58 & F59 Nuforms due to the directional pattern. 48" w standard and split corners are not possible for the above referenced Nuform.
- 1" thick worksurfaces are not available in laminate
- Stretcher bars are required to be specified with worksurfaces 54" and wider which do have any mid support- ensure not to interfere with support brackets, cable trays or other work tools

NOTES

In order to get a total cost on products when an upcharge or downcharge is present you take the list price of the product number and add the upcharge or deduct the downcharge cost shown to the list price.

For example:

Product INCR3636-22 in Nuform Select with a tapered edge would be \$505 +\$52 +\$29

Product INCR3636-22 in Nuform Select with a 1" straight edge would be \$505 +\$52 -\$51

| Part number | W | D | 1 1/4" straight edge Nuform classic/ laminate/base price | Nuform select | Nuform tapered edge | Nuform 1" straight edge | Grade 1 laminate 1 1/4" straight edge only |
|---|-----|-----|--|------------------|------------------------|----------------------------|--|
|  INCR3636-22 | 36" | 24" | \$505 | +\$52 | +\$29 | -\$51 | +\$164 |
| INCR4242-22 | 42" | 24" | \$719 | +\$74 | +\$37 | -\$73 | +\$233 |
| INCR4848-22 | 48" | 24" | \$875 | +\$89 | +\$47 | -\$83 | +\$282 |

Standard Corners
24" returns

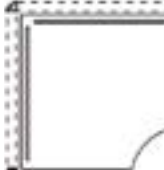
| | | | | | | | |
|--|-----|-----|-------|-------|-------|-------|--------|
|  INCR4242-33 | 42" | 30" | \$719 | +\$74 | +\$37 | -\$73 | +\$233 |
| INCR4848-33 | 48" | 30" | \$875 | +\$89 | +\$47 | -\$83 | +\$282 |

Standard Corners
30" returns

| | | | | | | | |
|--|-----|-----------|--------|-------|---|-------|--------|
|  INCSLS4242-22 | 42" | 24" | \$1546 | +\$64 | — | -\$63 | +\$496 |
| INCSLS4848 | 48" | 24 or 30" | \$1711 | +\$70 | — | -\$69 | +\$549 |

Split Corners

Worksurfaces & Supports

Panel Mounted Worksurfaces
Extended Corners

System

PRODUCT CODE KEY EXAMPLE

| | |
|--------------|-------------------------------|
| INECR6036-22 | |
| INCR | Inscape System |
| ECR | Extended corner worksurfaces |
| 60 | 60" W |
| 36 | 36" long |
| -22 | 24" deep returns on both ends |

- Depth dimension is nominal. Depths are 1" less than stated to provide a 1" gap between the worksurface and panel to facilitate wire management.
- Extended Corners accommodate 24" deep returns
- When manually specifying worksurface in laminate, add suffix "-S" to the code
- Optional pencil groove with Nuform
- To manually specify Nuform worksurfaces; begin with thickness then build up options
- 1" thick worksurfaces are not available in laminate
- Stretcher bars are required to be specified with worksurfaces 54" and wider which do have any mid support- ensure not to interfere with support brackets, cable trays or other work tools

NOTES

In order to get a total cost on products when an upcharge or downcharge is present you take the list price of the product number and add the upcharge or deduct the downcharge cost shown to the list price.

For example:

Product INECR6036-22 in Nuform Select with a tapered edge would be \$826 +\$86 +\$45

Product INECR6036-22 in Nuform Select with a 1" straight edge would be \$826 +\$86 -\$85

| | Part number | W | D | 1 1/4" straight edge Nuform classic/ laminate/base price | Nuform select | Nuform tapered edge | Nuform 1" straight edge | Grade 1 laminate 1 1/4" straight edge only |
|--|---------------------|-----|-----|--|------------------|------------------------|----------------------------|--|
|  | INECR6036-22 | 60" | 24" | \$826 | +\$86 | +\$45 | -\$85 | +\$266 |
| | INECR6636-22 | 66" | 24" | \$843 | +\$89 | +\$45 | -\$88 | +\$272 |
| | INECR7236-22 | 72" | 24" | \$859 | +\$90 | +\$47 | -\$89 | +\$277 |
| | INECR7836-22 | 78" | 24" | \$875 | +\$91 | +\$47 | -\$90 | +\$282 |
| | INECR8436-22 | 84" | 24" | \$897 | +\$92 | +\$48 | -\$91 | +\$288 |
| | INECR9036-22 | 90" | 24" | \$914 | +\$94 | +\$48 | -\$93 | +\$294 |
| | INECR9636-22 | 96" | 24" | \$933 | +\$94 | +\$50 | -\$93 | +\$300 |

36" Left Hand
Extended Corners

| | | | | | | | | |
|---|---------------------|-----|-----|-------|-------|-------|-------|--------|
|  | INECR3660-22 | 60" | 24" | \$826 | +\$86 | +\$45 | -\$85 | +\$266 |
| | INECR3666-22 | 66" | 24" | \$843 | +\$89 | +\$45 | -\$88 | +\$272 |
| | INECR3672-22 | 72" | 24" | \$859 | +\$90 | +\$47 | -\$89 | +\$277 |
| | INECR3678-22 | 78" | 24" | \$875 | +\$91 | +\$47 | -\$90 | +\$282 |
| | INECR3684-22 | 84" | 24" | \$897 | +\$92 | +\$48 | -\$91 | +\$288 |
| | INECR3690-22 | 90" | 24" | \$914 | +\$94 | +\$48 | -\$93 | +\$294 |
| | INECR3696-22 | 96" | 24" | \$933 | +\$94 | +\$50 | -\$93 | +\$300 |

36" Right Hand
Extended Corners

Worksurfaces & Supports

Panel Mounted Worksurfaces
Extended Corners

System

PRODUCT CODE KEY EXAMPLE

INECR6036-22

INCR Inscape System

ECR Extended corner worksurfaces

60 60" W

36 36" long

-22 24" deep returns on both ends

- Depth dimension is nominal. Depths are 1" less than stated to provide a 1" gap between the worksurface and panel to facilitate wire management.
- Extended Corners accommodate 24" deep returns
- When manually specifying worksurface in laminate, add suffix "-S" to the code
- Optional pencil groove with Nuform
- To manually specify Nuform worksurfaces; begin with thickness then build up options
- 1" thick worksurfaces are not available in laminate
- Stretcher bars are required to be specified with worksurfaces 54" and wider which do have any mid support- ensure not to interfere with support brackets, cable trays or other work tools

NOTES

In order to get a total cost on products when an upcharge or downcharge is present you take the list price of the product number and add the upcharge or deduct the downcharge cost shown to the list price.

For example:

Product INECR6036-22 in Nuform Select with a tapered edge would be \$826 +\$86 +\$45

Product INECR6036-22 in Nuform Select with a 1" straight edge would be \$826 +\$86 -\$85

| | Part number | W | D | 1 1/4" straight edge Nuform classic/ laminate/base price | Nuform select | Nuform tapered edge | Nuform 1" straight edge | Grade 1 laminate 1 1/4" straight edge only |
|--|---------------------|-----|-----|--|------------------|------------------------|----------------------------|--|
|  | INECR6042-22 | 60" | 24" | \$869 | +\$89 | +\$46 | -\$88 | +\$280 |
| | INECR6642-22 | 66" | 24" | \$885 | +\$91 | +\$46 | -\$90 | +\$285 |
| | INECR7242-22 | 72" | 24" | \$904 | +\$92 | +\$47 | -\$91 | +\$291 |
| | INECR7842-22 | 78" | 24" | \$923 | +\$94 | +\$48 | -\$93 | +\$296 |
| | INECR8442-22 | 84" | 24" | \$943 | +\$96 | +\$48 | -\$94 | +\$304 |
| | INECR9042-22 | 90" | 24" | \$962 | +\$97 | +\$51 | -\$97 | +\$310 |
| | INECR9642-22 | 96" | 24" | \$980 | +\$102 | +\$52 | -\$100 | +\$316 |

42" Left Hand
Extended Corners

| | | | | | | | | |
|---|---------------------|-----|-----|-------|--------|-------|--------|--------|
|  | INECR4260-22 | 60" | 24" | \$869 | +\$89 | +\$46 | -\$88 | +\$280 |
| | INECR4266-22 | 66" | 24" | \$885 | +\$91 | +\$46 | -\$90 | +\$285 |
| | INECR4272-22 | 72" | 24" | \$904 | +\$92 | +\$47 | -\$91 | +\$291 |
| | INECR4278-22 | 78" | 24" | \$923 | +\$94 | +\$48 | -\$93 | +\$296 |
| | INECR4284-22 | 84" | 24" | \$943 | +\$96 | +\$48 | -\$94 | +\$304 |
| | INECR4290-22 | 90" | 24" | \$962 | +\$97 | +\$51 | -\$97 | +\$310 |
| | INECR4296-22 | 96" | 24" | \$980 | +\$102 | +\$52 | -\$100 | +\$316 |

42" Right Hand
Extended Corners

Worksurfaces & Supports

Panel Mounted Worksurfaces
Extended Corners

System

PRODUCT CODE KEY EXAMPLE

| | |
|--------------|-------------------------------|
| INECR6042-33 | |
| IN | Inscape System |
| ECR | Extended corner worksurfaces |
| 60 | 60" W |
| 42 | 42" long |
| -33 | 30" deep returns on both ends |

- Depth dimension is nominal. Depths are 1" less than stated to provide a 1" gap between the worksurface and panel to facilitate wire management.
- Extended Corners accommodate 30" deep returns
- When manually specifying worksurface in laminate, add suffix "-S" to the code
- Optional pencil groove with Nuform
- To manually specify Nuform worksurfaces; begin with thickness then build up options
- 1" thick worksurfaces are not available in laminate
- Stretcher bars are required to be specified with worksurfaces 54" and wider which do have any mid support- ensure not to interfere with support brackets, cable trays or other work tools

NOTES

In order to get a total cost on products when an upcharge or downcharge is present you take the list price of the product number and add the upcharge or deduct the downcharge cost shown to the list price.

For example:

Product INECR6042-33 in Nuform Select with a tapered edge would be \$1017 +\$104 +\$52

Product INECR6042-33 in Nuform Select with a 1" straight edge would be \$1017 +\$104 -\$102

| | Part number | W | D | 1 1/4" straight edge Nuform classic/ laminate/base price | Nuform select | Nuform tapered edge | Nuform 1" straight edge | Grade 1 laminate 1 1/4" straight edge only |
|--|---------------------|-----|-----|--|------------------|------------------------|----------------------------|--|
|  | INECR6042-33 | 60" | 30" | \$1017 | +\$104 | +\$52 | -\$102 | +\$327 |
| | INECR6642-33 | 66" | 30" | \$1037 | +\$108 | +\$56 | -\$105 | +\$333 |
| | INECR7242-33 | 72" | 30" | \$1059 | +\$108 | +\$56 | -\$105 | +\$341 |
| | INECR7842-33 | 78" | 30" | \$1138 | +\$118 | +\$58 | -\$115 | +\$366 |
| | INECR8442-33 | 84" | 30" | \$1160 | +\$177 | +\$72 | -\$115 | +\$373 |
| | INECR9042-33 | 90" | 30" | \$1208 | +\$187 | +\$72 | -\$115 | +\$388 |
| | INECR9642-33 | 96" | 30" | \$1237 | +\$197 | +\$72 | -\$112 | +\$397 |

42" Left Hand
Extended Corners

| | | | | | | | | |
|---|---------------------|-----|-----|--------|--------|-------|--------|--------|
|  | INECR4260-33 | 60" | 30" | \$1017 | +\$104 | +\$52 | -\$102 | +\$327 |
| | INECR4266-33 | 66" | 30" | \$1037 | +\$108 | +\$56 | -\$105 | +\$333 |
| | INECR4272-33 | 72" | 30" | \$1059 | +\$108 | +\$56 | -\$105 | +\$341 |
| | INECR4278-33 | 78" | 30" | \$1138 | +\$118 | +\$58 | -\$115 | +\$366 |
| | INECR4284-33 | 84" | 30" | \$1160 | +\$177 | +\$72 | -\$115 | +\$373 |
| | INECR4290-33 | 90" | 30" | \$1208 | +\$187 | +\$72 | -\$115 | +\$388 |
| | INECR4296-33 | 96" | 30" | \$1237 | +\$197 | +\$72 | -\$112 | +\$397 |

42" Right Hand
Extended Corners

Worksurfaces & Supports

Panel Mounted Worksurfaces

120° Corners

System

PRODUCT CODE KEY EXAMPLE

INCRV3636-3F

| | |
|-------------|--------------------------------|
| IN | Inscape System |
| CRV | 120 corner worksurfaces |
| 3636 | 36" X 36" W |
| -3F | 3 1/2" thick frame application |

- Depth dimension is nominal. Depths are 1" less than stated to provide a 1" gap between the worksurface and panel to facilitate wire management.
- 120° worksurfaces accommodate 24" deep returns on either side
- "2F" denotes use with 2 3/4" thick frame, "3F" denotes use with 3 1/2" thick frame
- When manually specifying worksurface in laminate, add suffix "-S" to the code
- Optional pencil groove with Nuform
- To manually specify Nuform worksurfaces; begin with the desired thickness then build up options
- 1" thick worksurfaces are not available in laminate
- Stretcher bars are required to be specified with worksurfaces 54" and wider which do have any mid support– ensure not to interfere with support brackets, cable trays or other work tools

NOTES

In order to get a total cost on products when an upcharge or downcharge is present you take the list price of the product number and add the upcharge or deduct the downcharge cost shown to the list price.

For example:

Product INCRV3636-2F in Nuform Select with a tapered edge would be \$539 +\$54 +\$31

Product INCRV3636-2F in Nuform Select with a 1" straight edge would be \$539 +\$54 -\$53

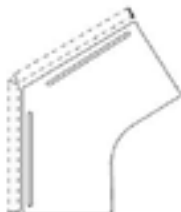
| | Part number | W | D | 1 1/4" straight edge Nuform classic/ laminate/base price | Nuform select | Nuform tapered edge | Nuform 1" straight edge | Grade 1 laminate 1 1/4" straight edge only |
|--|---------------------|-----|-----|--|------------------|------------------------|----------------------------|--|
|  | INCRV3636-3F | 36" | 24" | \$539 | +\$54 | +\$31 | -\$53 | +\$174 |
| | INCRV4242-3F | 42" | 24" | \$767 | +\$79 | +\$43 | -\$77 | +\$247 |
| | INCRV4848-3F | 48" | 24" | \$939 | +\$94 | +\$48 | -\$93 | +\$302 |

120° Corner Worksurfaces
For use with 3 1/2" T Frames

| | | | | | | | | |
|---|---------------------|-----|-----|-------|-------|-------|-------|--------|
|  | INCRV3636-2F | 36" | 24" | \$539 | +\$54 | +\$31 | -\$53 | +\$174 |
| | INCRV4242-2F | 42" | 24" | \$767 | +\$79 | +\$43 | -\$77 | +\$247 |
| | INCRV4848-2F | 48" | 24" | \$939 | +\$94 | +\$48 | -\$93 | +\$302 |

120° Corner Worksurfaces
For use with 2 3/4" T Frames

Worksurfaces & Supports

Panel Mounted Worksurfaces
Conference Tops

System

PRODUCT CODE KEY EXAMPLE

INCTR3060

| | |
|------------|----------------|
| IN | Inscape System |
| CTR | Conference top |
| 30 | 30" D |
| 60 | 60" W |

- Conference Tops are 1" less in width to provide 1" gap between worksurface and panel
- Conference Tops depths are true sized
- When manually specifying worksurface in laminate, add suffix "-S" to the code
- Optional pencil groove with Nuform
- To manually specify Nuform worksurfaces; begin with the desired thickness then build up options
- Support brackets to panel and leg specified separately
- 1" thick worksurfaces are not available in laminate
- Stretcher bars are required to be specified with worksurfaces 54" and wider which do have any mid support- ensure not to interfere with support brackets, cable trays or other work tools

NOTES

In order to get a total cost on products when an upcharge or downcharge is present you take the list price of the product number and add the upcharge or deduct the downcharge cost shown to the list price.

For example:

Product INCTR3060 in Nuform Select would be \$823 +\$88

Product INCTR3060 in Nuform Select with a 1" straight edge would be \$823 +\$88 -\$87

| | Part number | W | D | 1 1/4" straight edge Nuform classic/ laminate/base price | Nuform select | Nuform tapered edge | Nuform 1" straight edge | Grade 1 laminate 1 1/4" straight edge only |
|--|------------------|----------|-----|--|------------------|------------------------|----------------------------|--|
|  | INCTR3060 | 60 (59)" | 30" | \$823 | +\$88 | — | -\$87 | +\$265 |
| | INCTR3066 | 66 (65)" | 30" | \$875 | +\$91 | — | -\$90 | +\$282 |
| | INCTR3072 | 72 (71)" | 30" | \$974 | +\$94 | — | -\$52 | +\$314 |
| | INCTR3078 | 78 (77)" | 30" | \$1092 | +\$112 | — | -\$108 | +\$351 |

Rectangular Top
Top only

| | | | | | | | | |
|---|------------------|----------|-----|--------|--------|---|--------|--------|
|  | INCTB3060 | 60 (59)" | 30" | \$823 | +\$88 | — | -\$87 | +\$265 |
| | INCTB3066 | 66 (65)" | 30" | \$876 | +\$91 | — | -\$90 | +\$282 |
| | INCTB3072 | 72 (71)" | 30" | \$976 | +\$100 | — | -\$76 | +\$314 |
| | INCTB3078 | 78 (77)" | 30" | \$1092 | +\$112 | — | -\$108 | +\$351 |

Bullet Top
Top only

Worksurfaces & Supports

Transaction tops
General Information

System

Transaction tops are commonly specified for reception areas but have a variety of applications including help desks and banks.

Transaction Tops are commonly specified with 37" high panels. Widths indicated refer to panel width. Stanchions and top trim are included. Installed height of transaction top on 37" high panel is 41 1/2". Transaction Top worksurfaces are 1" thick and available in Nuform options. The edge detail is straight only. Transaction tops are panel thickness specific.

The suffix "2F" denotes compatibility with 2 3/4" thick panel, "3F" denotes compatibility with 3 1/2" thick panel.

Note: 72", 84" and 96" W kits consist of two top caps and four stanchions (based on "Symmetrical Frame Configuration" module lines). Top Caps can be specified as an option and are included with the kit.

GENERAL

- Straight-line transaction tops are available
- Straight-line transaction tops are 12" deep and are available in the following widths: 24", 30", 36", 42", 48", 54", 60", 72", 84" and 96"
- Transaction tops may be specified for 37" standard frames. Overall height of 37" high frame and transaction top is 41 1/2"
- All transaction tops shorter than 72" W are supported by 2 stanchions
- Transaction tops 72" or wider include two top trims and four stanchions
- A top trim with two cutouts, to accommodate the stanchions, is included with each transaction top
- Stanchions are not height adjustable
- Do not specify upper deck electrical beneath

PRODUCT CODE KEY EXAMPLE

INTT1236-3F

| | |
|------|--|
| INTT | Inscape System rectangular transaction top |
| 12 | 12" D |
| 36 | 36" W |
| 3F | 3 1/2" thick frame application |

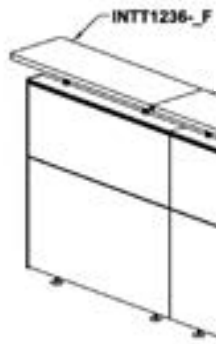

Worksurfaces & Supports

Transaction Tops
For 3 1/2" Thick Frames

System

- Straight Edge Nuform worksurface
- 1" thick worksurface
- Specific frame configurations only for the spanning tops
- 72" (36" top caps), 84" (42" top caps) and 96" (48" top caps) wide kits consist of two top caps and four stanchions
- On-module installation only
- Stanchions have a rectangular profile

NOTES

In order to get a total cost on products when an upcharge or downcharge is present you take the list price of the product number and add the upcharge or deduct the downcharge cost shown to the list price.

For example:

Product INTT1224-3F in Nuform Select with tapered trim would be \$374 +\$21

| | Part number | H | W | Tapered trim | | Flat trim | | Accent paint |
|--|--------------------|-----|-----|--|------------------|--|------------------|--------------|
| | | | | 1" Straight edge Nuform classic/base price | 1" Nuform select | 1" Straight edge Nuform classic/base price | 1" Nuform select | |
|  <p>Rectangular Transaction Top</p> | INTT1224-3F | 12" | 24" | \$374 | +\$21 | \$374 | +\$21 | +\$39 |
| | INTT1230-3F | 12" | 30" | \$400 | +\$22 | \$400 | +\$22 | +\$44 |
| | INTT1236-3F | 12" | 36" | \$426 | +\$23 | \$426 | +\$23 | +\$46 |
| | INTT1242-3F | 12" | 42" | \$451 | +\$25 | \$451 | +\$25 | +\$48 |
| | INTT1248-3F | 12" | 48" | \$486 | +\$27 | \$486 | +\$27 | +\$51 |
| | INTT1254-3F | 12" | 54" | \$511 | +\$29 | \$511 | +\$29 | +\$53 |
| | INTT1260-3F | 12" | 60" | \$517 | +\$29 | \$517 | +\$29 | +\$54 |
| | INTT1272-3F | 12" | 72" | \$848 | +\$45 | \$848 | +\$45 | +\$88 |
| | INTT1284-3F | 12" | 84" | \$898 | +\$47 | \$898 | +\$47 | +\$92 |
| | INTT1296-3F | 12" | 96" | \$961 | +\$50 | \$961 | +\$50 | +\$99 |

Worksurfaces & Supports

Transaction Tops
For 2 3/4" Thick Frames

System

- Straight Edge Nuform worksurface
- 1" thick worksurface
- Specific frame configurations only for the spanning tops
- 72" (36" top caps), 84" (42" top caps) and 96" (48" top caps) wide kits consist of two top caps and four stanchions
- On-module installation only
- Stanchions have a rectangular profile

NOTES

In order to get a total cost on products when an upcharge or downcharge is present you take the list price of the product number and add the upcharge or deduct the downcharge cost shown to the list price.

For example:

Product INTT1224-2F in Nuform Select with flat trim would be \$374 +\$21

| | Part number | H | W | Tapered trim | | Flat trim | | Accent paint |
|---|-------------|-----|-----|--|------------------|--|------------------|--------------|
| | | | | 1" Straight edge Nuform classic/base price | 1" Nuform select | 1" Straight edge Nuform classic/base price | 1" Nuform select | |
|  Rectangular Transaction Top | INTT1224-2F | 12" | 24" | — | — | \$374 | +\$21 | +\$39 |
| | INTT1230-2F | 12" | 30" | — | — | \$400 | +\$22 | +\$44 |
| | INTT1236-2F | 12" | 36" | — | — | \$426 | +\$23 | +\$46 |
| | INTT1242-2F | 12" | 42" | — | — | \$451 | +\$25 | +\$48 |
| | INTT1248-2F | 12" | 48" | — | — | \$486 | +\$27 | +\$51 |
| | INTT1254-2F | 12" | 54" | — | — | \$511 | +\$29 | +\$53 |
| | INTT1260-2F | 12" | 60" | — | — | \$517 | +\$29 | +\$54 |
| | INTT1272-2F | 12" | 72" | — | — | \$848 | +\$45 | +\$88 |
| | INTT1284-2F | 12" | 84" | — | — | \$898 | +\$47 | +\$92 |
| | INTT1296-2F | 12" | 96" | — | — | \$961 | +\$50 | +\$99 |

END GABLE & END GABLE BRACKETS

End gable & end gable brackets support panel mounted worksurfaces 28.5" high and. The left and right-handed brackets match the height of the end gable. End gables and brackets are available in any of Inscape's standard paint finishes and are frame thickness specific.

'H' LEG

'H' leg is a freestanding leg which may also be specified in a panel mounted application. Small glides provide leveling capability.

'O' LEG

'O' leg is a fully welded 'O' structure which mounts to the underside of a worksurface. This leg is freestanding.

FRAMED LEG

Framed leg is a panel mounted worksurface support that has the bracket to attach to panel incorporated in the design. Legs are specified based on depth of worksurface. Small leveling glide included with no glide cap. For version with glide cap see standard specials.

CANTILEVER BRACKET

Cantilever brackets support panel mounted worksurfaces on-module and are available in fixed or adjustable. Brackets are handed and adjustable to achieve 5 standard worksurface heights: 24.5", 27", 28.5", 30" and 31.5". Fixed cantilever brackets do not adjust vertically.

MID SPAN CANTILEVER BRACKET

The mid span cantilever bracket is specified when there is a long tile being specified in the zone directly above the bottom 20.25" H tile which would interfere with the middle upright for a standard cantilever to attach into. The Mid Span Cantilever mounts lower to the upright allowing the wide tile aesthetic.

CORNER CANTILEVER BRACKET

The corner cantilever bracket is specified where the 1" gap behind a worksurface wraps around a corner.

BRIDGE BRACKET

Bridge bracket install onto Cantilever brackets only. These brackets are handed and an adjustable version is available to achieve the same five heights as Cantilever brackets. Fixed bridge brackets do not adjust vertically and must only be specified with fixed Cantilever brackets.

FLUSH BRACKETS

Flush brackets are specified when two adjoining worksurfaces need to be held flush together and come in pairs. Maximum span of overhang when supported with a flush bracket is 18" per side.

MULTI SURFACE SUPPORT BRACKETS

Multi surface support brackets are adjustable to achieve five standard worksurface heights: 25.5", 27", 28.5", 30" and 31.5". MSSB's provide corner support for panel-mounted worksurfaces, support panel mounted conference tops and provide mid-span support for worksurfaces up to 72" W. MSSB's are handed and may be specified for either thickness of Inscape System panel. Fixed Multi-surface Support Brackets are available and do not adjust vertically.

FRONT EDGE SUPPORT BRACKETS

Front edge support brackets provide front edge support for 24" and 30" deep worksurfaces and also dock freestanding tables to panel's on-module. Brackets may be positioned to achieve five standard worksurface heights. Front Edge Support Brackets are handed and may be specified for either thickness of panel.

FRAMED LEG FRONT SUPPORT BRACKET

The framed leg front support bracket provides additional stability to a wing panel which is longer than the depth of the adjacent worksurface. The bracket must have access to a crossrail (at any location within the height of the leg) via a segmentation in tiles. The bracket is then double side taped to the inside of the leg.

PLANNA SUPPORT BRACKET

Planna support bracket is specified to be mounted on Planna rail and floats the worksurface off the bracket. Bracket is available in all standard paint colors. Bracket "snaps" into the rail without the need for tools. These are shipped as a pair and both must be installed per worksurface.

HAT CHANNEL

Hat channels are used to support a worksurface off of a 21" ID Planna storage case and are available in any of Inscape's standard paint finishes. They are nominal in height and support a worksurface at a standard 28.5" height.

WORKSURFACE STRETCHER BAR

Worksurface stretcher bar is additional structural support for unsupported worksurfaces of 54" or greater. It is 1 ½" high and the length of the stretcher bar is chosen based on the width of the worksurface. Be sure that there are no legs or panel mounted worksurface support brackets that may interfere with the stretcher bar.

WORKSURFACE TO TOWER BRACKET

This bracket is attached to a storage unit with screws (included) to support a worksurface from the underside. The 18" W bracket is used in a lateral, bookcase or locker application. The 24" W bracket is used with modular and workplace towers. These brackets are painted. Silicone caps to cover exposed screw tips are provided.

1.5" SCREEN DOCKING BRACKETS

Brackets dock the screen to a worksurface but are NOT worksurface supporting. Worksurfaces must always be freestanding. The Single Docking bracket docks one surface to a screen, the double docks two surfaces on either side of the screen. The Front edge docks the front edge of a freestanding table to the edge of a screen. Mid Span Docking bracket simply dock the mid of the worksurface to the 1.5" screen but does not support it.

Worksurfaces & Supports

Supports

Panel Mounted Worksurface Supports

System



- Worksurface support brackets are universal between two panel thicknesses (unless otherwise stated)
- Value Engineer Option – Eco Black finish
- If visible it is suggested the paint option be chosen
- Cantilevers cannot be specified to support 20"d or less worksurfaces

NOTES

In order to get a total cost on products when an upcharge or downcharge is present you take the list price of the product number and add the upcharge or deduct the downcharge cost shown to the list price.

For example:

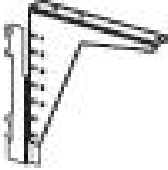
INLHCBFX in neutral paint would be \$46 +\$13INLHCBFX
in accent paint would be \$46 +\$13 +\$8

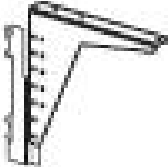
| | | Part number | H | Wt (lbs) | Eco black/ base price | Neutral paint | Accent paint |
|---|--|--------------------|---|----------|--------------------------|------------------|-----------------|
|  | Cantilever Bracket Fixed Height Handed | INLHCBFX | — | 5 | \$46 | +\$13 | +\$8 |
| | | INRHCBFX | — | 5 | \$46 | +\$13 | +\$8 |
|  | Cantilever Bracket Adjustable Height Handed | INLHCB | — | 5 | \$54 | +\$20 | +\$9 |
| | | INRHCB | — | 5 | \$54 | +\$20 | +\$9 |
|  | Mid Span Cantilever Bracket Fixed Height Handed | INLHCBS | — | 5 | \$81 | +\$13 | +\$11 |
| | | INRHCBS | — | 5 | \$81 | +\$13 | +\$11 |
|  | Corner Cantilever Bracket Adjustable Height Handed | INLHCB1CRNR | — | 5 | \$93 | +\$13 | +\$12 |
| | | INRHCB1CRNR | — | 5 | \$93 | +\$13 | +\$12 |

Worksurfaces & Supports

Supports

Panel Mounted Worksurface Supports

System



- Worksurface support brackets are universal between two panel thicknesses (unless otherwise stated)
- Value Engineer Option – Eco Black finish
- If visible it is suggested the paint option be chosen
- Cantilevers cannot be specified to support 20" d or less worksurfaces

NOTES

In order to get a total cost on products when an upcharge or downcharge is present you take the list price of the product number and add the upcharge or deduct the downcharge cost shown to the list price.

For example:

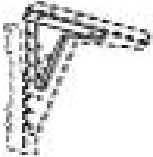
INBBFX in neutral paint would be \$16 +\$8 INBBFX in accent paint would be \$16 +\$8 +\$6

| | | Part number | H | Wt (lbs) | Eco black/ base price | Neutral paint | Accent paint |
|---|---|--|--------|----------|--------------------------|------------------|-----------------|
|  | Bridge Bracket Fixed Height | INBBFX | — | 1 | \$16 | +\$8 | +\$6 |
|  | Bridge Bracket Adjustable Height Handed | INLBB INRBB | — — | 1 1 | \$25 \$25 | +\$11 +\$11 | +\$6 +\$6 |
|  | Multi Surface Support Bracket Fixed Height Handed | INLHMSSBFX INRHMSSBFX | — — | 2 2 | \$22 \$22 | +\$8 +\$8 | +\$6 +\$6 |
|  | Multi Surface Support Bracket Adjustable Height Handed | INLHMSSB INRHMSSB | — — | 2 2 | \$36 \$36 | +\$11 +\$11 | +\$7 +\$7 |

Worksurfaces & Supports

Supports

Panel Mounted Worksurface Supports

System

- Worksurface support brackets are universal between two panel thicknesses (unless otherwise stated)
- Value Engineer Option – Eco Black finish
- If visible it is suggested the paint option be chosen
- A break in tile segmentation (horizontally) below the worksurface must be present for the Framed Leg Front Support Bracket to attach to the crossrail of the panel
- "H" Leg Docking Bracket ties an "H" leg or "O" leg into a frame





NOTES

In order to get a total cost on products when an upcharge or downcharge is present you take the list price of the product number and add the upcharge or deduct the downcharge cost shown to the list price.

For example:

INLHFSB in neutral paint would be \$27 +\$20

INLHFSB in accent paint would be \$27 +\$20 +\$7

| | | Part number | H | Wt (lbs) | Eco black/ base price | Neutral paint | Accent paint |
|---|--|--------------------|---|----------|--------------------------|------------------|-----------------|
|  | Front Edge Support Bracket | INLHFSB | — | 1 | \$27 | +\$20 | +\$7 |
| | Fixed Height Handed | INRHFSB | — | 1 | \$27 | +\$20 | +\$7 |
|  | Framed Leg Front Support Bracket | INLHPFRSB | — | 1 | — | \$37 | +\$8 |
| | Adjustable Height Handed | INRHHPFRSB | — | 1 | — | \$37 | +\$8 |
|  | "H" Leg Docking Bracket For use with 3 1/2" T Frames | INLHHLDB-3F | — | 1 | — | \$87 | +\$12 |
| | Handed | INRHHLDB-3F | — | 1 | — | \$87 | +\$12 |
|  | "H" Leg Docking Bracket For use with 2 3/4" T Frames | INLHHLDB-2F | — | 1 | — | \$87 | +\$12 |
| | Handed | INRHHLDB-2F | — | 1 | — | \$87 | +\$12 |







Worksurfaces & Supports

Supports

Panel Mounted Worksurface Supports

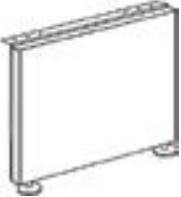
System

- “2F” denotes use with 2 ¾" thick frame, “3F” denotes use with 3 ½" thick frame
- Worksurface support brackets are universal between two panel thicknesses (unless otherwise stated)
- Value Engineer Option – Eco Black finish
- If support is visible it is suggested the paint option be chosen
- End panel must be docked to the frame with brackets
- Frame Support Leg mounts to both thicknesses of panel
- Frame Support Legs are handed and based on which side of frame attaching to
- The Center Frame Support Leg cannot be used in an end location

| | | Part number | H | Wt (lbs) | Eco black/ base price | Neutral paint | Accent paint |
|---|--|------------------------|-------|----------|--------------------------|------------------|-----------------|
|  | End Panel Bracket For use with 3 ½" T Frames Handed | INLHEGB28.5-3F | 28 ½" | 5 | — | \$94 | +\$12 |
| | | INRHEGB28.5-3F | 28 ½" | 5 | — | \$94 | +\$12 |
|  | End Panel Bracket For use with 2 ¾" T Frames Handed | INLHEGB28.5-2F | 28 ½" | 5 | — | \$94 | +\$12 |
| | | INRHEGB28.5-2F | 28 ½" | 5 | — | \$94 | +\$12 |
|  | End Panel | INEG2428.5 | 28 ½" | 50 | — | \$351 | +\$36 |
| | | INEG3028.5 | 28 ½" | 50 | — | \$357 | +\$37 |
|  | Left Hand Frame Support Leg New Style | INLFRMLEG2428.5 | 28 ½" | 24" | | \$391 | +\$43 |
| | | INLFRMLEG3028.5 | 28 ½" | 30" | | \$438 | +\$47 |
| | | INLFRMLEG3628.5 | 28 ½" | 36" | | \$488 | +\$51 |
|  | Right Hand Frame Support Leg New Style | INRFRMLEG2428.5 | 28 ½" | 24" | | \$391 | +\$43 |
| | | INRFRMLEG3028.5 | 28 ½" | 30" | | \$438 | +\$47 |
| | | INRFRMLEG3628.5 | 28 ½" | 36" | | \$488 | +\$51 |
|  | Centre Framed Support Leg New Style | INCFRMLEG2428.5 | 28 ½" | 24" | | \$391 | +\$43 |
| | | INCFRMLEG3028.5 | 28 ½" | 30" | | \$438 | +\$47 |
| | | INCFRMLEG3628.5 | 28 ½" | 36" | | \$488 | +\$51 |

Worksurfaces & Supports

Supports
Worksurface Supports

System

- Value Engineer Option – Eco Black finish
- If bracket visible it is suggested the paint option be chosen
- Stretcher bars are required to be specified with worksurfaces 54" and wider which do have any mid support– ensure not to interfere with support brackets, cable trays or other work tools
- Stretcher bars are 1 ½" high

NOTES







In order to get a total cost on products when an upcharge or downcharge is present you take the list price of the product number and add the upcharge or deduct the downcharge cost shown to the list price.

For example:

INWMB24-36 in neutral paint would be \$33

+\$11INWMB24-36 in accent paint would be \$33 +\$11

+\$7

| | | Part number | Wt (lbs) | | | List price | | |
|---|---|----------------------------|----------|----------|--------------------------|------------------|-----------------|--|
|  | Flush Bracket Kit of 2 | INFB | 0.2 | | | \$18 | | |
|  | 20" Flush Bracket | INFB20 | 1 | | | \$26 | | |
|  | Screws for Worksurfaces (box of 100) | INCBSCREWS | 0.5 | | | \$29 | | |
| | | Part number | W | Wt (lbs) | Eco black/ base price | Neutral paint | Accent paint | |
|  | Worksurface Stretcher Bar For use with worksurfaces 54" and wider | INSBK54 | 44" | — | \$77 | — | — | |
| | | For use with 54" surface | | | | | | |
| | | INSBK60 | 50" | — | \$114 | — | — | |
| | | For use with 60" surface | | | | | | |
| | | INSBK72 | 62" | — | \$135 | — | — | |
| For use with 72" surface | | | | | | | | |
| | | INSBK84 | 74" | — | \$162 | — | — | |
| For use with 84" surface | | | | | | | | |
| | | INSBK96 | 86" | — | \$183 | — | — | |
| For use with 96" surface | | | | | | | | |
|  | Wall Mount Bracket | INWMB24-36 | 24-36" | — | \$33 | +\$11 | +\$7 | |
| | | INWMB42-54 | 42-54" | — | \$44 | +\$13 | +\$8 | |
| | | INWMB60-72 | 60-72" | — | \$59 | +\$18 | +\$9 | |
|  | Storage to worksurface bracket | INMTWBKT-18 | 18" | — | — | \$36 | +\$7 | |
| | | Lateral/locker application | | | | | | |
| | | INMTWBKT-24 | 24" | — | — | \$53 | +\$9 | |
| Modular tower application | | | | | | | | |



Worksurfaces & Supports

Supports

Planna Worksurface Support Brackets

System

- Planna Storage Support Brackets are shipped as a pair and are both required per Planna Storage worksurface installation
- Hat Chanel heights are nominal and they support a standard worksurface height of 28.5"

| | | Part number | H | Wt (lbs) | Natural paint/ base price | Accent paint |
|---|--|----------------------|--------|----------|------------------------------|-----------------|
|  | Planna Bracket (pair) Adjustable Height | PSUPBKT | — | 1 | \$92 | +\$12 |
|  | 9" W x 2.89"H Hat Channel For use over Planna case with 1/2" top with no rail | HATCHNL2.89 | 2.89" | 2 | \$52 | +\$9 |
|  | 9" W x 2.375"H Hat Channel For use over Planna case with 1/2" top and 1/2" rail | HATCHNL2.3759 | 2.375" | 2 | \$52 | +\$9 |





Worksurfaces & Supports

Supports

Legs and Leg Docking Brackets

System

- Height adjustable leg provides manual adjustability to five heights -25.5", 27", 28.5", 30", 31.5"
- Legs are available in any of Inscape's standard paint colors
- To adjust the height there are two bolts that unthread and then pull out so that inner leg can then move up and down

| | | Part number | H | Wt (lbs) | Natural paint/ base price | Accent paint |
|---|---|---------------------|-------|----------|------------------------------|-----------------|
|  | "H" Leg Fixed Height | INHLEG2428.5 | 28 ½" | — | \$485 | +\$51 |
| | | INHLEG3028.5 | 28 ½" | — | \$511 | +\$53 |
| | | INHLEG3628.5 | 28 ½" | — | \$529 | +\$56 |
| | | | | | | |
|  | "O" Leg Fixed Height | INOLEG2428.5 | 28 ½" | — | \$403 | +\$44 |
| | | INOLEG3028.5 | 28 ½" | — | \$416 | +\$45 |
| | | INOLEG3628.5 | 28 ½" | — | \$421 | +\$45 |
|  | Post Leg Fixed Height Existing Storwal Storage version | INLEG28.5F | 28 ½" | 3 | \$192 | +\$22 |
|  | Post Leg Fixed Height | INPLEG28.5F | 28 ½" | 5 | \$199 | +\$22 |
|  | Post Leg Adjustable Height | INPLEGM | 28 ½" | 7 | \$319 | +\$34 |



Worksurfaces & Supports

Supports

Legs and Leg Docking Brackets

System

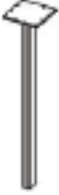
- Height adjustable leg provides manual adjustability to five heights -25.5", 27", 28.5", 30", 31.5"
- Legs are available in any of Inscape's standard paint colors
- The Triangular post leg provides concealed wire management

| | | Part number | H | Wt (lbs) | Natural paint/ base price | Accent paint |
|---|--------------------------------|-----------------------|-------|----------|------------------------------|-----------------|
|  | Round Post Leg Fixed Height | INFFLEG28.5 | 28 ½" | 4 | \$89 | +\$12 |
|  | Rectangular Post Leg | INRECPLEG-28.5 | 28 ½" | — | \$171 | +\$20 |
|  | Triangular Leg Fixed Height | INTWMLEG-28.5 | 28 ½" | — | \$258 | +\$27 |



Worksurfaces & Supports

Supports

1 1/2" Screen Worksurfaces Docking Brackets

System

- Docking brackets only, not worksurface supporting - legs for surfaces are required
- Compatible with 1" and 1 1/4" thick worksurfaces
- Brackets are available in any of Inscape's standard paint colors

| | | Part number | Wt (lbs) | Natural paint/ base price | Accent paint |
|---|--|----------------|----------|------------------------------|-----------------|
|  | 1.5" Screen Single Docking Bracket | FWSDB | 2 | \$30 | +\$7 |
|  | 1.5" Screen Back to Back Docking Bracket | FWSBDB | 2 | \$47 | +\$8 |
| | 1.5" Screen Front Edge Docking Bracket | FWSFESB | 2 | \$33 | +\$7 |
|  | 1.5" Screen Mid-Span Docking Bracket | FF-MSSB | 1 | \$23 | +\$6 |

System Storage

inscape

work for tomorrow

Storage
Lock locations

System

For all product lines except modular towers and Nuform.

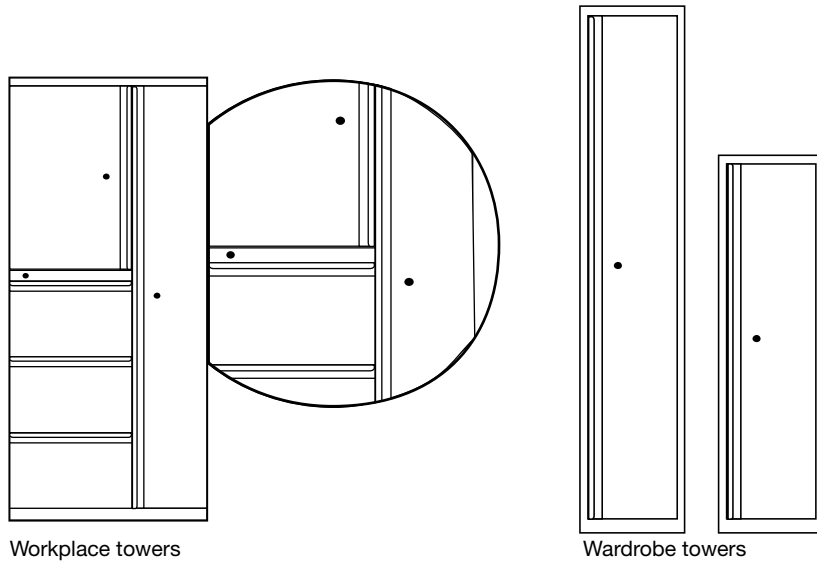
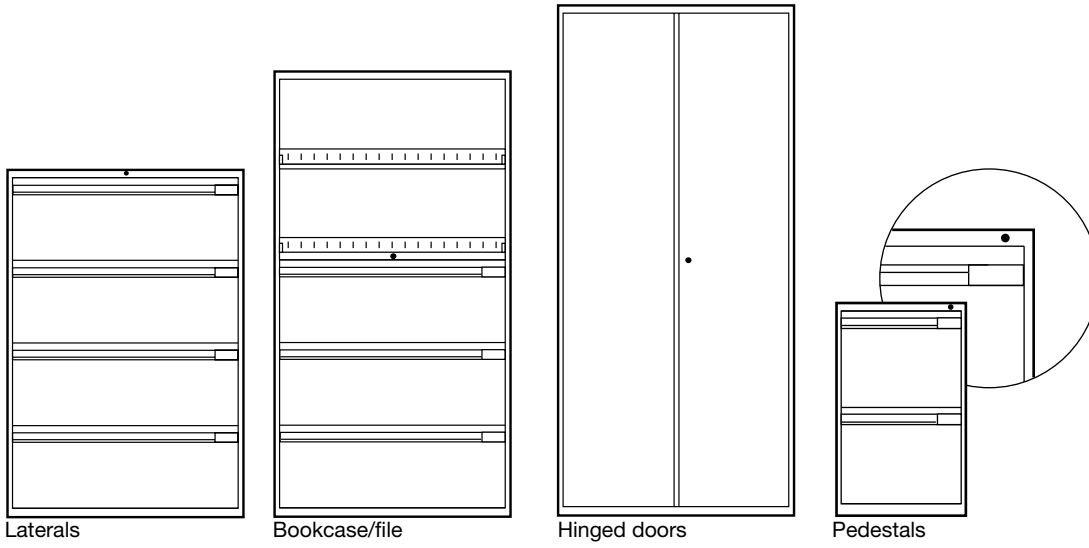

Storage
Lock locations

System

Nuform.

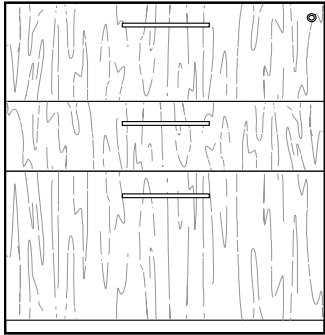

Laterals

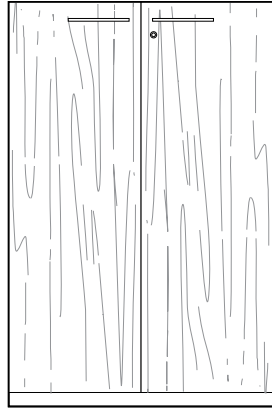

Hinged doors
- 24" interior height

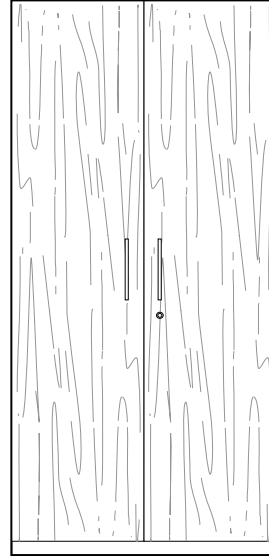

Hinged doors
- all except 24" interior height

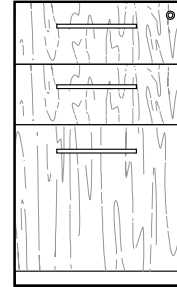

Pedestals

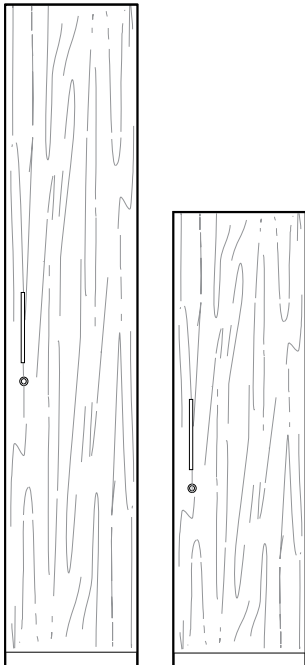

Wardrobe towers

Pedestals are of all-welded "wrap-around" construction of 20 and 22 gauge high quality, tension leveled, cold rolled steel. The steel gauge selected for drawer fronts, bodies and accessories ensure the highest quality durability and performance for all components. All glides on cases consist of flat glides with $\frac{5}{8}$ " height adjustability. Pedestal corners are welded at junction of top and case, eliminating horizontal lines for a cleaner, flush appearance, and strengthened with reinforcing gussets. A completely enclosed case provides rigid construction and dust-free interiors.

ANSI/BIFMA

With the addition of counterweights where appropriate, cabinets meet all BIFMA specifications.

CONSTRUCTION FEATURES & BENEFITS

Box drawer sides are slotted on 1" centers to allow for maximum flexibility for drawer division. Double-wall construction allows lift-up doors to be picked up and recede smoothly, eliminates deformation, ensures flush fit within cabinet and improves lock performance. Storage with Handles is single-wall construction. File (10.5" and 12") and EDP (15") drawer bodies have full-height sides to accommodate hanging file folders, eliminating the need for optional file frames. Fully progressive ball bearing suspensions on all drawers, including pencil and box drawers, are staged so that the left and right sides work in unison; this provides smooth drawer operation with minimum force. Staged suspensions allow the drawer to be completely pulled out, providing access to the entire drawer depth.

Special "claw-like" device incorporated in the suspension "grips" the fixed section of the suspension channel preventing drawer body bounce back or creep when drawer is closed. Modular interior allows complete interchangeability of drawer types within the pedestal case. For example, two 6" box drawers may be replaced by a 12" file drawer. Pedestals are standard with keyholes for attachment to underside of worksurface. For the Storage with Handles only cases: 18" deep pedestals come standard with 18" deep drawers, 22" and 28" deep pedestals come standard with 22" deep drawers. For all other Series, pedestal drawers match case depth.

Pedestals are available in mobile and worksurface supporting. Worksurface supporting pedestals are designed for use with the Inscape System and are standard with flat glides. Worksurface supporting pedestals are available in two depths to fit under 24" and 30" deep worksurfaces and support finished worksurface height of 28.5". Pedestals with 3", 6" or 7.5" drawers have the option to order one pencil tray per pedestal. The 6" and 7.5" drawers have the additional option to order one steel divider. The 10.5" and 12" drawers have the option to order one hang file suspension bar (two in a 28" deep pedestal) for side-to-side filing of legal or letter size folders or printout binders. Storage with Handles Pedestals do not include any suspension bars.

NOTE: System storage pedestal cases consist of holes in the top of the case and back of the case to allow for worksurface docking and panel mounted brackets to be secured.

COUNTERWEIGHTS

Counterweights are required for ALL freestanding units that are not anchored or ganged to other cabinets or bolted to walls/floor. Counterweights come standard with ALL mobile pedestals and must be field installed.

OPTIONAL HANDLE

Mobile Pedestals have the option to select a face mounted contemporary style handle for the case. There is an upcharge of \$32 list if this handle is selected. This handle is available in two finish options: Brushed Nickel (default) or Polished Nickel.

DOCKING BRACKET

The pedestal docking bracket docks a pedestal to an Inscape System panel on-module. Specify bracket according to case front style and based on the thickness of panel. Pedestal -to-panel brackets are available in full height version.

GLIDES

Inscape System pedestals are standard with flat glides. Glides provide 0.125" height adjustment when docked and 0.75" height adjustment if unit is not docked. 2 glides in front and 2 in back are adjustable from inside the cabinet so that cabinets can be leveled regardless of whether they are backed against a wall or banked.

LOCKS

Standard with single bitted lock. If lock is not required add suffix '**NL**' after product number and deduct \$57 list per lock. For applications requiring higher security a double bitted solution is available. Random keying is standard, and keyed alike may be ordered. Master keys are available; refer to the accessories section to specify.

Cabinets originally ordered as non-locking may be field installed with the addition of locking bars and a lock core. Contact your client services representative for required parts.

Locks feature removable core and are standard with two keys, one of which has a black neoprene plastic key cover. Locks may be ordered for field installation. Specify cabinet height and width or model number.

NOTE: Locks cannot be field installed on hinged door cabinets.



9900 Series NOTE: Pedestals with 9900 series fronts must be specified beneath 1" Nuform worksurfaces only.

FINISHES

All laterals are finished in standard 36.5° gloss baked enamel, electrostatically applied in a 2-coat process. Refer to the surface materials section for available colors. With the exception of custom micas, whites and metallic; custom colors are available at an up-charge and are be subject to extended lead times. All interior drawers/ shelf bodies, exposed hardware (excluding European style hinges) hang file bars, dividers and media frames are finished in Eco Black.

FRONT DETAILS & PULL OPTIONS

9900 Series fronts have full width integral pulls with enamel finish to match case fronts. Storage with Handles is single-wall construction. Refer to the images and chart below for pull application on Storage with Handles and Nuform fronts.

| Pull | Storage with Handles | Nuform |
|---|----------------------|--------|
|  FP001 P290 Aluminum Leaf Finish | ● | ● |
|  FP004 Brushed Nickel Finish | ● | ● |
|  FP005 Brushed Nickel Finish | ● | ○ |

● Available ○ Unavailable

Pulls FP004 and FP005 meet the guidelines for ADA compliance.

FP005 is the default pull for Storage with Handles

FP001 is the default pull for Nuform

CUSHION MOBILE PEDESTALS

The **Classic Cushion** is 1 ¼" thick CAL 117 compliant polyurethane foam with a 2.3 lb/ft. density. This upholstered cushion is balanced with a 7/16" board and is attached to the pedestal top with heavy duty Velcro. The 5-pc construction, features double row top stitching on all seams, seen in fine upholstered pieces. The result provides crisp rectilinear styling.

The **Lite Cushion** is ¾" thick CAL 117 compliant polyurethane foam with a 2.3 lb/ft. density. This upholstered cushion is balanced with a ¼" board and is attached to the pedestal top with Velcro. Our Lite Cushion has seamless features allowing it to highlight the fabric details. The result provides a modern and simple look.

The Lite Cushion is available in the following Grade A fabrics only: Fedora, Glint, Pebble, Rancho & Script

Select from our graded upholstery program of solid color fabrics and vinyl's or choose COM option (Customer Own Material). To determine if a COM fabric has been pre-approved for use on our cushion topper, contact your client services representative or log into INSITE. For application of ALL fabrics, both from our graded program as well as COM (Customer Own Material) please specify layout orientation at time of order. If layup instructions are not provided Inscape will choose the direction to maximize production. Refer to the diagram below for layup options.

After calculating the total amount of material needed in inches, divide the total number of inches by 36 for the total yardage and round up to the next full yard. Allow additional for repeat. Add 15% of total fabric required for small and medium pattern repeats. Add 20% of total fabric required for large patterns.

Due to the nature of the design and manufacture of our cushion, only approved fabrics will be accepted for application. For a description of the procedure required for COM fabric approval see sample 'Cushion COM Test Request' form found in the General Information section of this price list. This form can be downloaded from the Administration section of Insite or by contacting your client services representative for assistance.

All directional/patterned fabrics (Graded or COM) require cushion layup instructions with order placement. Depending on layup additional fabric may be required and upcharges may apply. If layup instructions are not provided the layup that maximizes the production yield will be chosen. (Refer to the layup diagrams)

Please see Finishes section for COM calculator.

FABRIC LAY UP OF PEDESTAL CUSHIONS

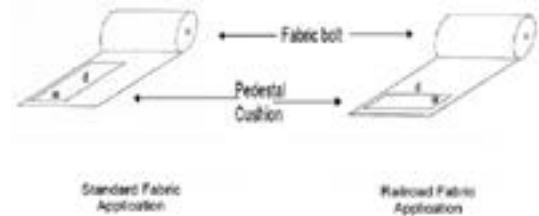

Storage

Pedestals

Storage with Handles Pedestals with Flat Glides

System



- Consult General Information for pull options
- Includes worksurface mounting holes in top and bracket slots in back of case
- 15" letter width pedestal
- Worksurface supporting for 28.5" high

OPTIONAL ACCESSORIES

All pedestal accessories are optional. See chart below for information on accessories by drawer height.

| Drawer Height | Product Code | Product Description | Price |
|--|--------------|-------------------------|-------|
| 3" & 4.5" | PFWS-PTxx | Pencil Tray | \$37 |
| 6" & 7.5" | PFWS-PTxx | Pencil Tray | \$37 |
| | PFWS-DVxx | Divider | \$22 |
| 18"D, 22"D, 28"D Pedestals Only (28"D requires 2 per drawer) | | | |
| 10.5", 12", 13.5, & 15" | PFSSFxx | Side-To-Side Filing Bar | \$8 |

Visit the [Pedestal Accessories](#) section for full accessory details.

| | Part number | H | W | D | Wt (lbs) | Neutral paint/ base price | Accent paint |
|---|----------------------|---------|-----|-----|----------|------------------------------|-----------------|
|  2-6" box, 12" file | GHF1522-2BF | 26 7/8" | 15" | 22" | 100 | \$1023 | +\$104 |
| | GHF1528-2BF | 26 7/8" | 15" | 28" | 110 | \$1077 | +\$110 |
|  2-12" files | GHF1522-2F | 26 7/8" | 15" | 22" | 100 | \$899 | +\$93 |
| | GHF1528-2F | 26 7/8" | 15" | 28" | 110 | \$927 | +\$96 |
|  3" pencil, 2-10.5" file | GHF1522-P2F10 | 26 7/8" | 15" | 22" | 100 | \$1023 | +\$104 |
| | GHF1528-P2F10 | 26 7/8" | 15" | 28" | 110 | \$1077 | +\$110 |

Storage

Pedestals

Storage with Handles Mobile Pedestals

System

- Consult General Information for pull options
- 15" letter width pedestal
- Pedestals that include a cushion come with Classic Cushion
- For application of ALL fabrics, both from our graded program as well as COM (customers own material), please specify layup orientation at time of order. If layup instructions are not provided we will choose the direction to maximize our production. Refer to the Finishes Section for additional layout and COM details.

NOTES

In order to get a total cost on products when upcharges are present take the list price of the product number and add the upcharge cost shown to the list price.

For example:

Product PH1518-BFMCNH in Grade B/COM fabric would be \$1124 +\$57

PH1518-BFMCNH in Grade C fabric would be \$1124 +\$103 **OPTIONAL ACCESSORIES**





All pedestal accessories are optional. See chart below for information an accessories by drawer height.

| Drawer Height | Product Code | Product Description | Price |
|---------------|--------------|---------------------|-------|
| 3" & 4.5" | PFWS-PTxx | Pencil Tray | \$37 |
| 6" & 7.5" | PFWS-PTxx | Pencil Tray | \$37 |
| | PFWS-DVxx | Divider | \$22 |

18"D, 22"D, 28"D Pedestals Only (28"D requires 2 per drawer)

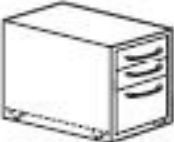
| Drawer Height | Product Code | Product Description | Price |
|-------------------------|--------------|-------------------------|-------|
| 10.5", 12", 13.5, & 15" | PFSSFxx | Side-To-Side Filing Bar | \$8 |

Visit the [Pedestal Accessories](#) section for full accessory details.

| | Part number | H | W | D | Wt (lbs) | Neutral paint/ Grade A/ base price | Accent paint |
|--|------------------------|---------|-----|-----|----------|--|-----------------|
|  <p>2-6" box, 10.5" file Mobile No cushion</p> | PH1518-2BF10M | 26" | 15" | 18" | 85 | \$1089 | +\$111 |
| | PH1522-2BF10M | 26" | 15" | 22" | 95 | \$1207 | +\$124 |
| | PH1528-2BF10M | 26" | 15" | 28" | 105 | \$1260 | +\$129 |
|  <p>10.5" file, 12" file Mobile No cushion</p> | PH1518-F10FM | 26" | 15" | 18" | 85 | \$1018 | +\$104 |
| | PH1522-F10FM | 26" | 15" | 22" | 95 | \$1089 | +\$111 |
| | PH1528-F10FM | 26" | 15" | 28" | 105 | \$1118 | +\$114 |
|  <p>6" box, 12" file Mobile Includes cushion, no handle</p> | PH1518-BFMCNH | 22 3/4" | 15" | 18" | 90 | \$1124 | +\$115 |
| | PH1522-BFMCNH | 22 3/4" | 15" | 22" | 100 | \$1165 | +\$119 |
| | PH1528-BFMCNH | 22 3/4" | 15" | 28" | 105 | \$1212 | +\$125 |
|  <p>7.5" box, 10.5" file Mobile Includes cushion, no handle</p> | PH1518B7F10MCNH | 22 3/4" | 15" | 18" | 90 | \$1089 | +\$111 |
| | PH1522B7F10MCNH | 22 3/4" | 15" | 22" | 100 | \$1212 | +\$125 |
| | PH1528B7F10MCNH | 22 3/4" | 15" | 28" | 105 | \$1260 | +\$129 |

FABRIC UPCHARGE FOR MOBILE CUSHION PEDESTALS - CLASSIC CUSHION OPTION ONLY

Note: To price fabric grade options, add the upcharge (+\$) in the chart below to the base price of the List price (Grade A) column.

This will be the total cost for that product.

| Grade B/COM | Grade C | Grade D | Grade E | Grade F |
|-------------|---------|---------|---------|---------|
| +\$57 | +\$103 | +\$145 | +\$174 | +\$249 |

Storage

Pedestals

9900 Series Front Pedestals with Flat Glides

System

- Includes worksurface mounting holes in top and bracket slots in back of case
- Worksurface supporting for 28.5" high
- Recommended installation below 1" worksurfaces only for clean aesthetic due to the tight corner radius of the worksurface

OPTIONAL ACCESSORIES



All pedestal accessories are optional. See chart below for information an accessories by drawer height.

| Drawer Height | Product Code | Product Description | Price |
|---------------|--------------|---------------------|-------|
| 3" & 4.5" | PFWS-PTxx | Pencil Tray | \$37 |
| 6" & 7.5" | PFWS-PTxx | Pencil Tray | \$37 |
| | PFWS-DVxx | Divider | \$22 |

18"D, 22"D, 28"D Pedestals Only (28"D requires 2 per drawer)

| | | | |
|-------------------------|---------|-------------------------|-----|
| 10.5", 12", 13.5, & 15" | PFSSFxx | Side-To-Side Filing Bar | \$8 |
|-------------------------|---------|-------------------------|-----|

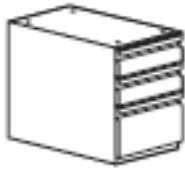
Visit the [Pedestal Accessories](#) section for full accessory details.

| | Part number | H | W | D | Wt (lbs) | Neutral paint/ base price | Accent paint |
|---|----------------------|---------|-----|---------|----------|------------------------------|-----------------|
|  2-12" files Flat Glides | GEF1522-2F | 26 7/8" | 15" | 22 3/4" | 100 | \$786 | +\$94 |
| | GEF1528-2F | 26 7/8" | 15" | 28 3/4" | 110 | \$863 | +\$98 |
| | Letter Width | | | | | | |
|  2-6" box, 1-12" file Flat Glides | GEF1522-2BF | 26 7/8" | 15" | 22 3/4" | 100 | \$918 | +\$105 |
| | GEF1528-2BF | 26 7/8" | 15" | 28 3/4" | 110 | \$1002 | +\$111 |
| | Letter Width | | | | | | |
|  3" pencil, 2-10.5" files Flat Glides | GEF1522-P2F10 | 26 7/8" | 15" | 22 3/4" | 100 | \$930 | +\$106 |
| | GEF1528-P2F10 | 26 7/8" | 15" | 28 3/4" | 110 | \$1002 | +\$111 |
| | Letter Width | | | | | | |

Storage

Pedestals

9900 Series Front Pedestals with Rectangular Glides

System

- Includes worksurface mounting holes in top and bracket slots in back of case
- Worksurface supporting for 28.5" high
- Recommended installation below 1" worksurfaces only for clean aesthetic due to the tight corner radius of the worksurface
- Rectangular glides are gray
- **Rectangular glides have an upcharge of \$29 per unit**

OPTIONAL ACCESSORIES



All pedestal accessories are optional. See chart below for information an accessories by drawer height.

| Drawer Height | Product Code | Product Description | Price |
|---------------|--------------|---------------------|-------|
| 3" & 4.5" | PFWS-PTxx | Pencil Tray | \$37 |
| 6" & 7.5" | PFWS-PTxx | Pencil Tray | \$37 |
| | PFWS-DVxx | Divider | \$22 |

18"D, 22"D, 28"D Pedestals Only (28"D requires 2 per drawer)

| | | | |
|-------------------------|---------|-------------------------|-----|
| 10.5", 12", 13.5, & 15" | PFSSFxx | Side-To-Side Filing Bar | \$8 |
|-------------------------|---------|-------------------------|-----|

Visit the [Pedestal Accessories](#) section for full accessory details.

| | Part number | H | W | D | Wt (lbs) | Neutral paint/ base price | Accent paint | |
|---|--|---------------------------------------|---------|-----|----------|------------------------------|-----------------|--------|
|  | 10.5" File, 12" File Rectangular Glides | INGE1522-F10F | 26 7/8" | 15" | 22 3/4" | 95 | \$914 | +\$94 |
| | | INGE1528-F10F Letter Width | 26 7/8" | 15" | 28 3/4" | 105 | \$950 | +\$98 |
|  | 2-6" box, 1-10.5" file Rectangular Glides | INGE1522-2BF10 | 26 7/8" | 15" | 22 3/4" | 95 | \$1036 | +\$105 |
| | | INGE1528-2BF10 Letter Width | 26 7/8" | 15" | 28 3/4" | 105 | \$1086 | +\$111 |
|  | 3" pencil, 7.5" box, and 12" file Rectangular Glides | INGE1522-PB7F | 26 7/8" | 15" | 22 3/4" | 95 | \$1038 | +\$106 |
| | | INGE1528-PB7F Letter Width | 26 7/8" | 15" | 28 3/4" | 105 | \$1090 | +\$111 |

Storage

Pedestals

9900 Series Front Mobile Pedestals

System

- 15" letter width mobile pedestals
- Pedestals that include a cushion have the option of Classic or Lite Cushion
- For application of ALL fabrics, both from our graded program as well as COM (customers own material), please specify layup orientation at time of order. If layup instructions are not provided we will choose the direction to maximize our production. Refer to the Finishes Section for additional layout and COM details.

NOTES

Optional face-mounted contemporary style handle available for mobile cushion pedestals, add \$32 list per pedestal. Handle is available in two finish options: Brushed Nickel (default) or Polished Nickel.

In order to get a total cost on products when upcharges are present take the list price of the product number and add the upcharge cost shown to the list price.

For example:

Product PF1518EBFMC in Grade B/COM fabric would be \$1002 +\$57
 PF1518EBFMC in Grade C fabric would be \$1002 +\$103



All pedestal accessories are optional. See chart below for information on accessories by drawer height.

| Drawer Height | Product Code | Product Description | Price |
|---------------|--------------|---------------------|-------|
| 3" & 4.5" | PFWS-PTxx | Pencil Tray | \$37 |
| 6" & 7.5" | PFWS-PTxx | Pencil Tray | \$37 |
| | PFWS-DVxx | Divider | \$22 |

18"D, 22"D, 28"D Pedestals Only (28"D requires 2 per drawer)

| Drawer Height | Product Code | Product Description | Price |
|-------------------------|--------------|-------------------------|-------|
| 10.5", 12", 13.5, & 15" | PFSSFx | Side-To-Side Filing Bar | \$8 |

Visit the [Pedestal Accessories](#) section for full accessory details.

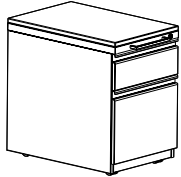
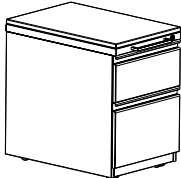
| | Part number | H | W | D | Wt (lbs) | Neutral paint/ Grade A/ base price | Accent paint |
|---|----------------|---------|-----|---------|----------|--|-----------------|
|  <p>3" pencil, 6" box and 12" file No cushion</p> | PE1518-PBFM | 24 1/2" | 15" | 18 3/4" | 85 | \$975 | +\$111 |
| | PE1522-PBFM | 24 1/2" | 15" | 22 3/4" | 95 | \$1058 | +\$121 |
| | PE1528-PBFM | 24 1/2" | 15" | 28 3/4" | 105 | \$1141 | +\$127 |
|  <p>2-10.5" files No cushion</p> | PE1518-2F10.5M | 24 1/2" | 15" | 18 3/4" | 85 | \$1031 | +\$105 |
| | PE1522-2F10.5M | 24 1/2" | 15" | 22 3/4" | 95 | \$1100 | +\$112 |
| | PE1528-2F10.5M | 24 1/2" | 15" | 28 3/4" | 105 | \$1138 | +\$116 |
|  <p>6" box, 12" file Includes cushion</p> | PF1518EBFMC | 22 3/4" | 15" | 18 3/4" | 90 | \$1002 | -\$114 +\$116 |
| | PF1522EBFMC | 22 3/4" | 15" | 22 3/4" | 100 | \$1058 | -\$114 +\$121 |
| | PF1528EBFMC | 22 3/4" | 15" | 28 3/4" | 110 | \$1125 | -\$114 +\$126 |
|  <p>7.5" box, 10.5" file Includes cushion</p> | PF1518EB7F10MC | 22 3/4" | 15" | 18 3/4" | 90 | \$1002 | -\$114 +\$116 |
| | PF1522EB7F10MC | 22 3/4" | 15" | 22 3/4" | 100 | \$1058 | -\$114 +\$121 |
| | PF1528EB7F10MC | 22 3/4" | 15" | 28 3/4" | 110 | \$1125 | -\$114 +\$126 |

FABRIC UPCHARGE FOR MOBILE CUSHION PEDESTALS - CLASSIC CUSHION OPTION ONLY

Note: To price fabric grade options, add the upcharge (+\$) in the chart below to the base price of the List price (Grade A) column. This will be the total cost for that product.

| Grade B/COM | Grade C | Grade D | Grade E | Grade F |
|-------------|---------|---------|---------|---------|
| +\$57 | +\$103 | +\$145 | +\$174 | +\$249 |

Storage

Pedestals

Nuform Front Pedestals with Flat Glides

System

- Consult General Information for pull options
- Includes worksurface mounting holes in top and bracket slots in back of case
- 15" letter width pedestal
- Worksurface supporting for 28.5" high
- Nuform Classic and colors available

OPTIONAL ACCESSORIES



All pedestal accessories are optional. See chart below for information an accessories by drawer height.

| Drawer Height | Product Code | Product Description | Price |
|---|--------------|-------------------------|-------|
| 3" & 4.5" | PFWS-PTxx | Pencil Tray | \$37 |
| 6" & 7.5" | PFWS-PTxx | Pencil Tray | \$37 |
| | PFWS-DVxx | Divider | \$22 |
| 18"D, 22"D, 28"D Pedestals Only (28"D requires 2 per drawer) | | | |
| 10.5", 12", 13.5, & 15" | PFSSFxx | Side-To-Side Filing Bar | \$8 |

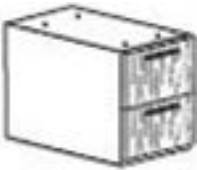
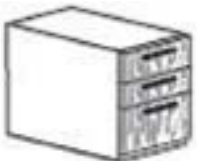

Visit the [Pedestal Accessories](#) section for full accessory details.

| | Part number | H | W | D | Wt (lbs) | Nuform classic/ neutral paint/ base price | Nuform select | Accent paint |
|---|--------------------|---------|-----|---------|----------|---|---------------|--------------|
|  2-12" files Flat Glides | GQF1522-2F | 26 7/8" | 15" | 22 3/4" | 95 | \$1232 | +\$137 | +\$126 |
| | GQF1528-2F | 26 7/8" | 15" | 28 3/4" | 105 | \$1408 | +\$157 | +\$142 |
|  2-6" box, 1-12" file Flat Glides | GQF1522-2BF | 26 7/8" | 15" | 22 3/4" | 95 | \$1376 | +\$153 | +\$140 |
| | GQF1528-2BF | 26 7/8" | 15" | 28 3/4" | 105 | \$1510 | +\$168 | +\$153 |

- Pedestal brackets are full height and may be painted to match case finish
- The height is nominal and includes the thickness of the worksurface above the storage
- Specific brackets are required for case type and mounting application
- "2F" denotes use with 2 ¾" thick frame
- "3F" denotes use with 3 ½" thick frame
- Brackets are handed and are ordered based on which side of the frame the bracket is being mounted to

| | | Part number | H | Wt (lbs) | Neutral paint/ base price | Accent paint |
|---|--|--|-------|----------|------------------------------|-----------------|
|  | Full Height Pedestal Docking Bracket for Storage with Handles series and Nuform fronts For use with 3 ½" T frames Handed | IN28.5PEDLH-3F left handed | 28 ½" | 2 | \$92 | +\$12 |
| | | IN28.5PEDRH-3F right handed | 28 ½" | 2 | \$92 | +\$12 |
|  | Full Height Pedestal Docking Bracket for 9900 Series fronts For use with 3 ½" T frames Handed | IN28.5PEDGLH-3F left handed | 28 ½" | 2 | \$92 | +\$12 |
| | | IN28.5PEDGRH-3F right handed | 28 ½" | 2 | \$92 | +\$12 |
|  | Full Height Pedestal Docking Bracket for Storage with Handles Series and Nuform fronts For use with 2 ¾" T frames Handed | IN28.5PEDLH-2F left handed | 28 ½" | 2 | \$92 | +\$12 |
| | | IN28.5PEDRH-2F right handed | 28 ½" | 2 | \$92 | +\$12 |

- Pedestal brackets are full height and may be painted to match case finish
- The height is nominal and includes the thickness of the worksurface above the storage
- Specific brackets are required for case type and mounting application
- "2F" denotes use with 2 ¾" thick frame
"3F" denotes use with 3 ½" thick frame
- Brackets are handed and are ordered based on which side of the frame the bracket is being mounted to

| | | Part number | H | Wt (lbs) | Neutral paint/ base price | Accent paint |
|---|---|------------------------|-------|----------|------------------------------|-----------------|
|  | Full Height Pedestal Docking Bracket for 9900 Series fronts For use with 2 ¾" T frames Handed | IN28.5PEDGLH-2F | 28 ½" | 2 | \$92 | +\$12 |
| | | left handed | | | | |
| | | IN28.5PEDGRH-2F | 28 ½" | 2 | \$92 | +\$12 |
| | | right handed | | | | |
|  | Full Height Pedestal Docking Bracket for Storage with Handles Series and Nuform fronts For use with 1 ½" T screens Handed | PEDBRKTLH | 28 ½" | 2 | \$48 | +\$8 |
| | | left handed | | | | |
| | | PEDBRKTRH | 28 ½" | 2 | \$48 | +\$8 |
| | | right handed | | | | |
|  | Full Height Pedestal Docking Bracket for 9900 Series fronts For use with 1 ½" T screens Handed | PEDBRKTLH | 28 ½" | 2 | \$48 | +\$8 |
| | | left handed | | | | |
| | | PEDBRKTRH | 28 ½" | 2 | \$48 | +\$8 |
| | | right handed | | | | |

Lateral cabinets are of all-welded construction using 20 and 22 gauge high quality, tension leveled, and cold rolled steel. Drawer fronts, lift-up doors, roll-out shelves and all steel accessories are manufactured of the steel gauge appropriate to function at the highest quality level.

ANSI/BIFMA

With the addition of counterweights where appropriate, cabinets meet all BIFMA specifications.

CONSTRUCTION FEATURES & BENEFITS

All interiors are completely modular and interchangeable so that cabinets can be retrofitted with new accessories and interiors as required. Cabinet corners are welded at junction of top and case, eliminating horizontal lines for cleaner, flush appearance, and strengthened with reinforcing gussets. Double-wall construction allows lift-up doors to be picked up and receded smoothly, eliminates deformation, ensures flush fit within cabinet and improves lock performance. Lift-up door carrier mechanism has four nylon rollers two on each side - for smooth receding action with no binding or snagging. Self-closing, 110° opening, European style cupboard hinges for smooth door operations. Storage with Handles Series storage is single-wall construction.

The absence of scissor mechanism in doors and drawers eliminates the potential for scissors binding, and facilitates reconfiguration of cabinet openings as needed. Front leading edge of pullout shelves is beaded and rolled to provide grip for pullout action and strengthen shelf; front leading edge of fixed shelf is flat for easy removal of material. Fully progressive ball bearing suspension slides provide smooth action with minimum force.

Special "claw-like" device incorporated in suspension slide channel "grips" the fixed section of the suspension channel preventing drawer bounce-back or creep when drawer is closed. A patented Safelock™ interlock mechanism provides complete security and user safety against accidental opening of two or more drawers simultaneously. Lock fingers are configured with right angle bend upward not downward so that lift-up doors cannot be pulled down to disengage fingers from door slots and be forced to circumvent lock system. Lock bars operate vertically on both sides of cabinet for maximum security.

Laterals include 1 pair of hang file bars in 10.5" and 12" fixed fronts, 1 EDP kit in 13.5" and 15" fixed fronts, pencil tray in 3" multi-file drawer and steel divider in 7.5" multi-file drawer, steel divider in 6" multi-file drawers and 3 divider plates in 13.5" liftups. Fixed shelf in lift-up is slotted in 1" increments. Lateral-to-panel bracket is required if lateral is positioned on-module.

NOTE: System storage laterals and multi-files consist of slots in the back of the case to allow for panel mounted brackets to be secured.

COUNTERWEIGHTS

Counterweights are required for ALL freestanding units that are not anchored or ganged to other cabinets or bolted to walls/floor. Counterweights come standard with ALL mobile pedestals and must be field installed.

DOCKING BRACKET

The Lateral Docking Bracket docks a lateral to an Inscape System panel on-module. Specify bracket according to depth of worksurface and based on the thickness of panel. Counterweights are not required for laterals which are tied into the panel and worksurface supporting.

GLIDES

Inscape System laterals are standard with flat glides. Glides provide 0.125" height adjustment when docked and 0.625" height adjustment if unit is not docked. 2 glides in front and 2 in back are adjustable from inside the cabinet so that cabinets can be leveled regardless of whether they are backed against a wall or banked.

LOCKS

Standard with single bitted lock. If lock is not required add suffix '**NL**' after product number and deduct \$57 list per lock. For applications requiring higher security a double bitted solution is available. Random keying is standard, and keyed alike may be ordered. Master keys are available; refer to the accessories section to specify.

Cabinets originally ordered as non-locking may be field installed with the addition of locking bars and a lock core. Contact your client services representative for required parts.

Locks feature removable core and are standard with two keys, one of which has a black neoprene plastic key cover. Locks may be ordered for field installation. Specify cabinet height and width or model number.

NOTE: Locks cannot be field installed on hinged door cabinets.

STORAGE STABILIZER BRACKET

Storage Stabilizer Bracket is specified when a storage case/Planna Storage lateral or pedestal is positioned directly adjacent to an Inscape System panel. This bracket does not create a gap between the case and the panel like a pedestal or lateral bracket does. No factory holes are required to be in the back of the case and are added at time of installation.

FINISHES

All laterals are finished in standard 36.5° gloss baked enamel, electrostatically applied in a 2-coat process. Refer to Finishes section for available colors. With the exception of custom micas, whites and metallic; custom colors are available at an up-charge and are be subject to extended lead times. All interior drawers/shelf bodies, exposed hardware (excluding European style hinges) hang file bars, dividers and media frames are finished in Eco Black.

COM

Select from our graded upholstery program of solid color fabrics and vinyl's or choose COM option (Customer Own Material). To determine if a COM fabric has been pre-approved for use on our cushion topper, contact your client services representative or log into INSITE. For application of ALL fabrics, both from our graded program as well as COM (Customer Own Material) please specify layout orientation at time of order. If layup instructions are not provided Inscape will choose the direction to maximize production. Refer to the diagram for layup options.

After calculating the total amount of material needed in inches, divide the total number of inches by 36 for the total yardage and round up to the next full yard. Allow additional for repeat. Add 15% of total fabric required for small and medium pattern repeats. Add 20% of total fabric required for large patterns.



Due to the nature of the design and manufacture of our cushion, only approved fabrics will be accepted for application. For a description of the procedure required for COM fabric approval see sample 'Cushion COM Test Request' form found in the General Information section of this price list. This form can be downloaded from the Administration section of Insite or by contacting your client services representative for assistance.

All directional/patterned fabrics (Graded or COM) require cushion layup instructions with order placement. Depending on layup additional fabric may be required and upcharges may apply. If layup instructions are not provided the layup that maximizes the production yield will be chosen. (Refer to the layup diagrams)

Please see Finishes section for COM calculator.

FRONT DETAILS & PULL OPTIONS

9900 Series fronts have full width integral pulls with enamel finish to match case fronts. Storage with Handles is single-wall construction. Refer to the images and chart below for pull application on Storage with Handles and Nuform fronts.

| Pull | Storage with Handles | Nuform |
|--|----------------------|--------|
|  FP001 P290 Aluminum Leaf Finish | ● | ● |
|  FP004 Brushed Nickel Finish | ● | ● |
|  FP005 Brushed Nickel Finish | ● | ○ |

● Available ○ Unavailable

Pulls FP004 and FP005 meet the guidelines for ADA compliance.

FP005 is the default pull for Storage with Handles
FP001 is the default pull for Nuform



Storage

Laterals

Storage with Handles Laterals with Flat Glides

System

- Includes slots in back for lateral to panel bracket, no holes on top
- Laterals are 18" deep
- Worksurface supporting for 28.5" high
- Consult General Information for pull options

| | | Part number | H | W | Wt (lbs) | Neutral paint/ base price | Accent paint |
|--|--|----------------------|---------|-----|----------|------------------------------|-----------------|
|  | 3" pencil, 2-10.5" file Flat Glides | GHF3024-P2F10 | 26 7/8" | 30" | 105 | \$1110 | +\$114 |
| | | GHF3624-P2F10 | 26 7/8" | 36" | 125 | \$1209 | +\$124 |
| | | GHF4224-P2F10 | 26 7/8" | 42" | 135 | \$1315 | +\$133 |
|  | 2-12" files Flat Glides | GHF3024-FF | 26 7/8" | 30" | 105 | \$927 | +\$96 |
| | | GHF3624-FF | 26 7/8" | 36" | 125 | \$1020 | +\$104 |
| | | GHF4224-FF | 26 7/8" | 42" | 135 | \$1123 | +\$115 |







Storage

Laterals

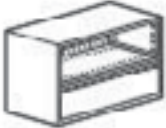
9900 Series Front Laterals with Flat Glides

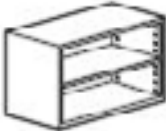
System

- Includes slots in back for lateral to panel bracket, no holes on top
- Laterals are 18" deep
- Worksurface supporting for 28.5" high

| | | Part number | H | W | Wt (lbs) | Neutral paint/ base price | Accent paint |
|--|--|----------------------|---------|-----|----------|------------------------------|-----------------|
|  | 13.5 bookcase Insert, 10.5" file Flat Glides | GEF3024-BKF10 | 26 7/8" | 30" | 100 | \$1092 | +\$111 |
| | | GEF3624-BKF10 | 26 7/8" | 36" | 125 | \$1170 | +\$120 |
| | | GEF4224-BKF10 | 26 7/8" | 42" | 135 | \$1272 | +\$130 |
|  | Display Cabinet Flat Glides | GEF3024-2MS | 26 7/8" | 30" | 100 | \$787 | +\$83 |
| | | GEF3624-2MS | 26 7/8" | 36" | 125 | \$832 | +\$87 |
| | | GEF4224-2MS | 26 7/8" | 42" | 135 | \$915 | +\$94 |
|  | 7.5" box, 16.5" bookcase insert Flat Glides | GEF3024-B7BK | 26 7/8" | 30" | 98 | \$1209 | +\$124 |
| | | GEF3624-B7BK | 26 7/8" | 36" | 108 | \$1286 | +\$131 |
| | | GEF4224-B7BK | 26 7/8" | 42" | 121 | \$1386 | +\$140 |
|  | Bookcase with 1 shelf Flat Glides Adjustable or fixed shelf options | GF3024-1BK18 | 26 7/8" | 30" | 49 | \$951 | +\$98 |
| | | GF3624-1BK18 | 26 7/8" | 36" | 57 | \$981 | +\$101 |
| | | GF4224-1BK18 | 26 7/8" | 42" | 65 | \$996 | +\$102 |
|  | 2-12" files Flat Glides | GEF3024-FF | 26 7/8" | 30" | 105 | \$1058 | +\$111 |
| | | GEF3624-FF | 26 7/8" | 36" | 125 | \$1107 | +\$123 |
| | | GEF4224-FF | 26 7/8" | 42" | 135 | \$1158 | +\$134 |
|  | 2-6" box, 12" file Flat Glides | GEF3024-2BF | 26 7/8" | 30" | 105 | \$1251 | +\$128 |
| | | GEF3624-2BF | 26 7/8" | 36" | 125 | \$1372 | +\$139 |
| | | GEF4224-2BF | 26 7/8" | 42" | 135 | \$1511 | +\$153 |
|  | 3" pencil, 2-10.5" files Flat Glides | GEF3024-P2F10 | 26 7/8" | 30" | 105 | \$1305 | +\$132 |
| | | GEF3624-P2F10 | 26 7/8" | 36" | 125 | \$1423 | +\$144 |
| | | GEF4224-P2F10 | 26 7/8" | 42" | 135 | \$1547 | +\$157 |
|  | 13.5 lift up with Fixed Shelf, 10.5" file Flat Glides | GEF3024-LUF10 | 26 7/8" | 30" | 105 | \$1091 | +\$111 |
| | | GEF3624-LUF10 | 26 7/8" | 36" | 125 | \$1205 | +\$124 |
| | | GEF4224-LUF10 | 26 7/8" | 42" | 135 | \$1333 | +\$135 |



Storage

Laterals

9900 Series Front Laterals with Rectangular Glides

System

- Includes slots in back for lateral to panel bracket, no holes on top
- Laterals are 18" deep
- Worksurface supporting for 28.5" high
- **Rectangular glides have an upcharge of \$29 per unit**

| | | Part number | H | W | Wt (lbs) | Neutral paint/ base price | Accent paint |
|---|---|------------------------|-------|-----|----------|------------------------------|-----------------|
|  | 10.5" file, 12" file Rectangular Glides | INGE3022.5-F10F | 25 ¼" | 30" | — | \$1095 | +\$111 |
| | | INGE3622.5-F10F | 25 ¼" | 36" | — | \$1200 | +\$123 |
| | | INGE4222.5-F10F | 25 ¼" | 42" | — | \$1318 | +\$134 |
|  | 2-6" box, 10.5" file Rectangular Glides | INGE3022.52BF10 | 25 ¼" | 30" | — | \$1251 | +\$128 |
| | | INGE3622.52BF10 | 25 ¼" | 36" | — | \$1384 | +\$140 |
| | | INGE4222.52BF10 | 25 ¼" | 42" | — | \$1511 | +\$153 |
|  | 3" pencil, 7.5" box ,12" file Rectangular Glides | INGE3022.5-PB7F | 25 ¼" | 30" | — | \$1123 | +\$115 |
| | | INGE3622.5-PB7F | 25 ¼" | 36" | — | \$1228 | +\$126 |
| | | INGE4222.5-PB7F | 25 ¼" | 42" | — | \$1344 | +\$137 |



Storage

Laterals





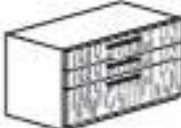

Nuform Front Laterals with Flat Glides

System



- Includes slots in back for lateral to panel bracket, no holes on top
- Laterals are 18" deep
- Worksurface supporting for 28.5" high
- FP001 pull is standard. Consult General Information for pull options
- Nuform Classic and Select colors available

| | | Part number | H | W | Wt (lbs) | Nuform classic/ neutral paint/ base price | Nuform select | Accent paint |
|---|---|---------------------|---------|-----|----------|---|---------------|--------------|
|  | 2-12" files Flat Glides | GQF3024-2FF | 26 7/8" | 30" | 95 | \$1473 | +\$164 | +\$148 |
| | | GQF3624-2FF | 26 7/8" | 36" | 105 | \$1583 | +\$175 | +\$161 |
| | | GQF4224-2FF | 26 7/8" | 42" | 115 | \$1640 | +\$182 | +\$167 |
|  | 2-6" box, 12" file Flat Glides | GQF3024-2BF | 26 7/8" | 30" | 95 | \$1773 | +\$197 | +\$180 |
| | | GQF3624-2BF | 26 7/8" | 36" | 105 | \$1892 | +\$209 | +\$192 |
| | | GQF4224-2BF | 26 7/8" | 42" | 115 | \$1976 | +\$219 | +\$200 |
|  | Nuform Front Hinged Door Cabinet with no interior accessories | GQF3024HD | 26 7/8" | 30" | 75 | \$1107 | +\$124 | +\$114 |
| | | GQF3624HD | 26 7/8" | 36" | 95 | \$1198 | +\$133 | +\$123 |
| | | GQF4224HD | 26 7/8" | 42" | 110 | \$1358 | +\$152 | +\$138 |
|  | Nuform Front Hinged Door Cabinet with 1 slotted shelf | GQF3024HD-SH | 26 7/8" | 30" | 75 | \$1207 | +\$134 | +\$124 |
| | | GQF3624HD-SH | 26 7/8" | 36" | 95 | \$1295 | +\$144 | +\$132 |
| | | GQF4224HD-SH | 26 7/8" | 42" | 110 | \$1458 | +\$162 | +\$147 |

- Lateral brackets are full height and may be painted to match case finish
- The height is nominal and includes the thickness of the worksurface above the storage
- Specific brackets are required for case type and for worksurfaces depth
- "2F" denotes use with 2 ¾" thick frame
- "3F" denotes use with 3 ½" thick frame
- Brackets are handed and are ordered based on which side of the frame the bracket is being mounted to

| | | Part number | H | Wt (lbs) | Neutral paint/ base price | Accent paint |
|---|---|--|-------|----------|------------------------------|-----------------|
|  | Full Height Lateral Docking Bracket for 24"D worksurfaces For Storage with Handles and 9900 series For use with 3 ½" T frames Handed | IN28.5LBLH-3F left handed | 28 ½" | 5 | \$101 | +\$13 |
| | | IN28.5LBRH-3F right handed | 28 ½" | 5 | \$101 | +\$13 |
|  | Full Height Lateral Docking Bracket for 24"D worksurfaces For GRID series For use with 3 ½" T frames Handed | IN28.5LBGLH-3F left handed | 28 ½" | 5 | \$101 | +\$13 |
| | | IN28.5LBGRH-3F right handed | 28 ½" | 5 | \$101 | +\$13 |
|  | Full Height Lateral Docking Bracket for 30"D worksurfaces For all series For use with 3 ½" T frames Handed | IN28.5LB30LH-3F left handed | 28 ½" | 5 | \$131 | +\$17 |
| | | IN28.5LB30RH-3F right handed | 28 ½" | 5 | \$131 | +\$17 |
|  | Full Height Lateral Docking Bracket for 24"D worksurfaces For Storage with Handles and 9900 Series For use with 2 ¾" T frames Handed | IN28.5LBLH-2F left handed | 28 ½" | 5 | \$101 | +\$13 |
| | | IN28.5LBRH-2F right handed | 28 ½" | 5 | \$101 | +\$13 |
|  | Full Height Lateral Docking Bracket for 24"D worksurfaces For GRID series For use with 2 ¾" T frames Handed | IN28.5LBGLH-2F left handed | 28 ½" | 5 | \$101 | +\$13 |
| | | IN28.5LBGRH-2F right handed | 28 ½" | 5 | \$101 | +\$13 |
|  | Full Height Lateral Docking Bracket for 30"D worksurfaces For all series For use with 2 ¾" T frames Handed | IN28.5LB30LH-2F left handed | 28 ½" | 5 | \$131 | +\$17 |
| | | IN28.5LB30RH-2F right handed | 28 ½" | 5 | \$131 | +\$17 |

- “2F” denotes use with 2 ¾" thick frame
- “3F” denotes use with 3 ½" thick frame
- Stabilizer brackets cannot be used with Modular Towers as they have chamfered corners

| | | Part number | Wt (lbs) | Neutral paint/ base price | Accent paint |
|---|---|------------------|----------|------------------------------|-----------------|
|  | Storage to Panel Stabilizer Bracket For use with 3 ½" T frames | INPSSB-3F | 1 | \$48 | +\$8 |
|  | Storage to Panel Stabilizer Bracket For use with 2 ¾" T frames | INPSSB-2F | 1 | \$48 | +\$8 |

Workplace Towers are constructed of all-welded construction using high quality, tension leveled cold rolled steel. The steel gauge selected for drawer fronts, bodies and accessories ensure the highest quality durability and performance for all components.

SAFELOCK™

The patented Safelock mechanism is standard on the 42" W locker and on towers and lockers that have more than one file (10.5" and 12") drawer. It provides complete security against accidental opening of two or more drawers simultaneously. When any drawer is extended, even fractionally, Safelock ensures that all other openings immediately become inoperable.

DRAWER STANDARD EQUIPMENT

On pre-configured units, Lockers and towers containing 3" or 6" drawers are provided with one pencil tray per cabinet. 6" drawers are additionally standard with one steel divider. 10.5", 12" and 15" letter-width file drawers have one suspension bar for side-to-side filing of letter or legal-size folders. Full-width pullout drawers are standard with one pair hang file bars for side-to-side suspended filing. Full-width fixed shelves are standard with 3 plate dividers. Optional accessories are available. Build ups are ordered separately.

GLIDES

Overall heights are inclusive of metal glides. Heights may be increased up to ¾" by extending the standard glide. Glides are accessible from inside the cabinet when the bottom drawer is fully extended or removed and may be adjusted with a 0.25" socket driver. Optional 1.5" stem glides are available.

LOCKS

Standard with single bitted lock. If lock is not required add suffix '/NL' after product number and deduct \$57 list per lock. For applications requiring higher security a double bitted solution is available. Random keying is standard, and keyed alike may be ordered. Master keys are available; refer to the accessories section to specify.

Cabinets originally ordered as non-locking may be field installed with the addition of locking bars and a lock core. Contact your client services representative for required parts.

Locks feature removable core and are standard with two keys, one of which has a black neoprene plastic key cover. Locks may be ordered for field installation. Specify cabinet height and width or model number.

Note: Locks cannot be field installed on hinged door cabinets.

WARDROBE UNITS

Freestanding wardrobe units are available in widths of 12", 15" and 18". The freestanding wardrobes match panel heights of 44", 51", 57" and 64" H. Wardrobe units are available in 9900 series, Nuform Classic and Select. Wardrobe units include the option of a coat rod and upper shelf or multiple shelves (quantities listed below)

44" H version includes 2 shelves

51" H version includes 2 shelves

57" H version includes 2 shelves

64" H version includes 3 shelves



Wardrobe units are locking and include flat glides on the freestanding versions.

FINISHES

All towers are finished in standard 36.5° gloss baked enamel, electrostatically applied in a 2-coat process. Refer to the surface materials section for available colors. With the exception of custom micas, whites and metallic; custom colors are available at an up-charge and are be subject to extended lead times. All interior drawers/ shelf bodies, exposed hardware (excluding European style hinges) hang file bars, dividers and media frames are finished in Eco Black.

FRONT DETAILS & PULL OPTIONS

9900 Series fronts have full width integral pulls with enamel finish to match case fronts. Storage with Handles is single-wall construction. Refer to the images and chart below for pull application on Storage with Handles and Nuform fronts.

| Pull | Storage with Handles | Nuform |
|---|----------------------|--------|
|  FP001 P290 Aluminum Leaf Finish | ● | ● |
|  FP004 Brushed Nickel Finish | ● | ● |
|  FP005 Brushed Nickel Finish | ● | ○ |

● Available ○ Unavailable

Pulls FP004 and FP005 meet the guidelines for ADA compliance.

FP005 is the default pull for Storage with Handles

FP001 is the default pull for Nuform

Storage

Towers
9900 Series Front Workplace Towers

System

- Towers are 24" deep
- Flat glides
- Glides which come standard with towers will level to lower than the actual frame height
- System glides are required to be ordered separately in order to match top of 64" H frame top trim

CAUTION: Un-level floors may result in towers with leveling higher than the frame top trim

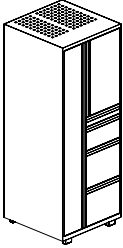
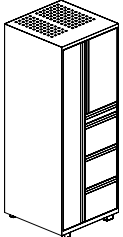
| | | Part number | H | W | Wt (lbs) | Neutral paint/ base price | Rectangular glides | Accent paint | |
|---|--|---------------------------------------|-----|-----|----------|------------------------------|-----------------------|-----------------|--|
|  | Full-length door 14 1/4" wide on one side, 24" hinged door insert, 1-3" pencil, 1-7.5" box and 2-12" file drawers 13 5/8" wide on the other Optional Rectangular Glides | GETL2458-PB7FF | 64" | 24" | — | \$3691 | +\$29 | +\$371 | |
| | | GETL3058-PB7FF | 64" | 30" | — | \$4225 | +\$29 | +\$426 | |
| | | left-handed hinged door (illustrated) | | | | | | | |
| | | GETR2458-PB7FF | 64" | 24" | — | \$3691 | +\$29 | +\$371 | |
|  | Full-length door 14 1/4" wide on one side, 24" hinged door insert, 1-3" pencil and 3-10.5" file drawers 13 5/8" wide on the other Optional Rectangular Glides | GETL2458-P3F10 | 64" | 24" | — | \$3691 | +\$29 | +\$371 | |
| | | GETL3058-P3F10 | 64" | 30" | — | \$4225 | +\$29 | +\$426 | |
| | | left-handed hinged door (illustrated) | | | | | | | |
| | | GETR2458-P3F10 | 64" | 24" | — | \$3691 | +\$29 | +\$371 | |
| | | GETR3058-P3F10 | 64" | 30" | — | \$4225 | +\$29 | +\$426 | |
| | | right-handed hinged door | | | | | | | |

- Option of mitten shelf with coat rod or shelves
- Use flat glides to match frame heights noted in descriptions
- Adding rectangular glides increases exterior height

NOTES

In order to get a total cost on products when upcharges are present take the list price of the product number and add the upcharge cost shown to the list price.

For example:

Product INVR121852E-HD with Rectangular Glides would be \$1524 +\$33

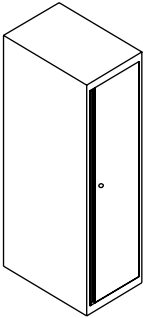
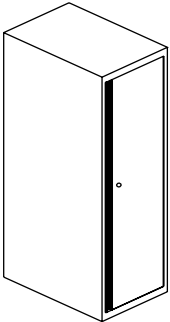
| | Part number | H | W | D | Flat & Round Glides | | Rectangular glides | Accent paint | |
|--|-------------------------|---------|-----|--------|---------------------------------|---------|--------------------|--------------|--|
| | | | | | Coat rod + shelf/ base price | Shelves | | | |
|  <p>9900 Series Wardrobe Tower to match 44" h panel</p> | INVL121839E-HD | 41 7/8" | 12" | 18" | \$1295 | \$1295 | +\$29 | +\$132 | |
| | INVL122439E-HD | 41 7/8" | 12" | 24" | \$1397 | \$1397 | +\$29 | +\$141 | |
| | INVL151839E-HD | 41 7/8" | 15" | 18" | \$1397 | \$1397 | +\$29 | +\$141 | |
| | INVL152439E-HD | 41 7/8" | 15" | 24" | \$1438 | \$1438 | +\$29 | +\$145 | |
| | INVL181839E-HD | 41 7/8" | 18" | 18" | \$1438 | \$1438 | +\$29 | +\$145 | |
| | INVL182439E-HD | 41 7/8" | 18" | 24" | \$1454 | \$1454 | +\$29 | +\$146 | |
| | left-handed hinged door | | | | | | | | |
| | INVR121839E-HD | 41 7/8" | 12" | 18" | \$1295 | \$1295 | +\$29 | +\$132 | |
| | INVR122439E-HD | 41 7/8" | 12" | 24" | \$1397 | \$1397 | +\$29 | +\$141 | |
| | INVR151839E-HD | 41 7/8" | 15" | 18" | \$1397 | \$1397 | +\$29 | +\$141 | |
| | INVR152439E-HD | 41 7/8" | 15" | 24" | \$1438 | \$1438 | +\$29 | +\$145 | |
| | INVR181839E-HD | 41 7/8" | 18" | 18" | \$1438 | \$1438 | +\$29 | +\$145 | |
| INVR182439E-HD | 41 7/8" | 18" | 24" | \$1454 | \$1454 | +\$29 | +\$146 | | |
| right-handed hinged door (illustrated) | | | | | | | | | |
|  <p>9900 Series Wardrobe Tower to match 51" h panel</p> | INVL121846E-HD | 49 3/8" | 12" | 18" | \$1401 | \$1401 | +\$29 | +\$142 | |
| | INVL122446E-HD | 49 3/8" | 12" | 24" | \$1479 | \$1479 | +\$29 | +\$148 | |
| | INVL151846E-HD | 49 3/8" | 15" | 18" | \$1479 | \$1479 | +\$29 | +\$148 | |
| | INVL152446E-HD | 49 3/8" | 15" | 24" | \$1562 | \$1562 | +\$29 | +\$160 | |
| | INVL181846E-HD | 49 3/8" | 18" | 18" | \$1562 | \$1562 | +\$29 | +\$160 | |
| | INVL182446E-HD | 49 3/8" | 18" | 24" | \$1645 | \$1645 | +\$29 | +\$168 | |
| | left-handed hinged door | | | | | | | | |
| | INVR121846E-HD | 49 3/8" | 12" | 18" | \$1401 | \$1401 | +\$29 | +\$142 | |
| | INVR122446E-HD | 49 3/8" | 12" | 24" | \$1479 | \$1479 | +\$29 | +\$148 | |
| | INVR151846E-HD | 49 3/8" | 15" | 18" | \$1479 | \$1479 | +\$29 | +\$148 | |
| | INVR152446E-HD | 49 3/8" | 15" | 24" | \$1562 | \$1562 | +\$29 | +\$160 | |
| | INVR181846E-HD | 49 3/8" | 18" | 18" | \$1562 | \$1562 | +\$29 | +\$160 | |
| INVR182446E-HD | 49 3/8" | 18" | 24" | \$1645 | \$1645 | +\$29 | +\$168 | | |
| right-handed hinged door (illustrated) | | | | | | | | | |

- Option of mitten shelf with coat rod or shelves
- Use flat glides to match frame heights noted in descriptions
- Adding rectangular glides increases exterior height

NOTES

In order to get a total cost on products when upcharges are present take the list price of the product number and add the upcharge cost shown to the list price.

For example:

Product INVL121852E-HD with Rectangular Glides would be \$1524 +\$33

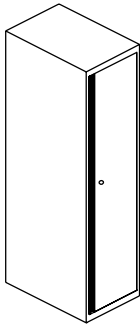
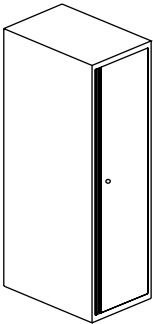
| | Part number | H | W | D | Flat & Round Glides | | Rectangular glides | Accent paint | |
|--|-------------------------|---------|-----|--------|---------------------------------|---------|--------------------|--------------|--|
| | | | | | Coat rod + shelf/ base price | Shelves | | | |
|  <p>9900 Series Wardrobe Tower to match 57" h panel</p> | INVL121852E-HD | 55 3/8" | 12" | 18" | \$1524 | \$1524 | +\$29 | +\$154 | |
| | INVL122452E-HD | 55 3/8" | 12" | 24" | \$1577 | \$1577 | +\$29 | +\$161 | |
| | INVL151852E-HD | 55 3/8" | 15" | 18" | \$1577 | \$1577 | +\$29 | +\$161 | |
| | INVL152452E-HD | 55 3/8" | 15" | 24" | \$1633 | \$1633 | +\$29 | +\$167 | |
| | INVL181852E-HD | 55 3/8" | 18" | 18" | \$1633 | \$1633 | +\$29 | +\$167 | |
| | INVL182452E-HD | 55 3/8" | 18" | 24" | \$1687 | \$1687 | +\$29 | +\$171 | |
| | left-handed hinged door | | | | | | | | |
| | INVR121852E-HD | 55 3/8" | 12" | 18" | \$1524 | \$1524 | +\$29 | +\$154 | |
| | INVR122452E-HD | 55 3/8" | 12" | 24" | \$1577 | \$1577 | +\$29 | +\$161 | |
| | INVR151852E-HD | 55 3/8" | 15" | 18" | \$1577 | \$1577 | +\$29 | +\$161 | |
| | INVR152452E-HD | 55 3/8" | 15" | 24" | \$1633 | \$1633 | +\$29 | +\$167 | |
| | INVR181852E-HD | 55 3/8" | 18" | 18" | \$1633 | \$1633 | +\$29 | +\$167 | |
| INVR182452E-HD | 55 3/8" | 18" | 24" | \$1687 | \$1687 | +\$29 | +\$171 | | |
| right-handed hinged door (illustrated) | | | | | | | | | |
|  <p>9900 Series Wardrobe Tower to match 64" h panel</p> | INVL121860E-HD | 62 7/8" | 12" | 18" | \$1557 | \$1557 | +\$29 | +\$159 | |
| | INVL122460E-HD | 62 7/8" | 12" | 24" | \$1645 | \$1645 | +\$29 | +\$168 | |
| | INVL151860E-HD | 62 7/8" | 15" | 18" | \$1645 | \$1645 | +\$29 | +\$168 | |
| | INVL152460E-HD | 62 7/8" | 15" | 24" | \$1692 | \$1692 | +\$29 | +\$172 | |
| | INVL181860E-HD | 62 7/8" | 18" | 18" | \$1692 | \$1692 | +\$29 | +\$172 | |
| | INVL182460E-HD | 62 7/8" | 18" | 24" | \$1739 | \$1739 | +\$29 | +\$177 | |
| | left-handed hinged door | | | | | | | | |
| | INVR121860E-HD | 62 7/8" | 12" | 18" | \$1557 | \$1557 | +\$29 | +\$159 | |
| | INVR122460E-HD | 62 7/8" | 12" | 24" | \$1645 | \$1645 | +\$29 | +\$168 | |
| | INVR151860E-HD | 62 7/8" | 15" | 18" | \$1645 | \$1645 | +\$29 | +\$168 | |
| | INVR152460E-HD | 62 7/8" | 15" | 24" | \$1692 | \$1692 | +\$29 | +\$172 | |
| | INVR181860E-HD | 62 7/8" | 18" | 18" | \$1692 | \$1692 | +\$29 | +\$172 | |
| INVR182460E-HD | 62 7/8" | 18" | 24" | \$1739 | \$1739 | +\$29 | +\$177 | | |
| right-handed hinged door (illustrated) | | | | | | | | | |

- Option of mitten shelf with coat rod or shelves
- Use flat glides to match frame heights noted in descriptions
- Adding rectangular glides increases exterior height
- Consult General Information for pull options
- Nuform Classic and Select colors available
- Optional shelves or coat rod with shelf can be selected

NOTES

Nuform Wardrobes are available with an eLock option. Add \$411 to list price for eLock.

eLocks come in two styles: Dead Bolt style or Slam style

There are two eLock types: Multi-use or Single-use

In order to get a total cost on products when upcharges are present take the list price of the product number and add the upcharge cost shown to the list price.

For example:

Product INVR121852Q-HD with Rectangular Glides would be \$1829 +\$33

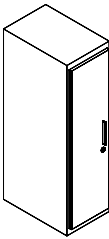
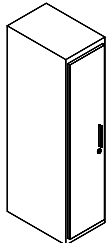
| | Part number | H | W | D | Flat & Round Glides | | Rectangular glides | Accent paint | |
|--|-------------------------|---------|-----|--------|-------------------------------|------------------------------|--------------------|--------------|--|
| | | | | | Nuform classic/ Neutral paint | Nuform select/ Neutral paint | | | |
|  <p>Nuform Wardrobe Tower to match 44" h panel eLock option available</p> | INVL121839Q-HD | 41 7/8" | 12" | 18" | \$1557 | +\$172 | +\$29 | +\$159 | |
| | INVL122439Q-HD | 41 7/8" | 12" | 24" | \$1678 | +\$185 | +\$29 | +\$171 | |
| | INVL151839Q-HD | 41 7/8" | 15" | 18" | \$1678 | +\$185 | +\$29 | +\$171 | |
| | INVL152439Q-HD | 41 7/8" | 15" | 24" | \$1725 | +\$192 | +\$29 | +\$175 | |
| | INVL181839Q-HD | 41 7/8" | 18" | 18" | \$1725 | +\$192 | +\$29 | +\$175 | |
| | INVL182439Q-HD | 41 7/8" | 18" | 24" | \$1743 | +\$194 | +\$29 | +\$177 | |
| | left-handed hinged door | | | | | | | | |
| | INVR121839Q-HD | 41 7/8" | 12" | 18" | \$1557 | +\$172 | +\$29 | +\$159 | |
| | INVR122439Q-HD | 41 7/8" | 12" | 24" | \$1678 | +\$185 | +\$29 | +\$171 | |
| | INVR151839Q-HD | 41 7/8" | 15" | 18" | \$1678 | +\$185 | +\$29 | +\$171 | |
| | INVR152439Q-HD | 41 7/8" | 15" | 24" | \$1725 | +\$192 | +\$29 | +\$175 | |
| | INVR181839Q-HD | 41 7/8" | 18" | 18" | \$1725 | +\$192 | +\$29 | +\$175 | |
| INVR182439Q-HD | 41 7/8" | 18" | 24" | \$1743 | +\$194 | +\$29 | +\$177 | | |
| right-handed hinged door (illustrated) | | | | | | | | | |
|  <p>Nuform Wardrobe Tower to match 51" h panel eLock option available</p> | INVL121846Q-HD | 49 3/8" | 12" | 18" | \$1683 | +\$187 | +\$29 | +\$171 | |
| | INVL122446Q-HD | 49 3/8" | 12" | 24" | \$1774 | +\$197 | +\$29 | +\$180 | |
| | INVL151846Q-HD | 49 3/8" | 15" | 18" | \$1774 | +\$197 | +\$29 | +\$180 | |
| | INVL152446Q-HD | 49 3/8" | 15" | 24" | \$1871 | +\$207 | +\$29 | +\$189 | |
| | INVL181846Q-HD | 49 3/8" | 18" | 18" | \$1871 | +\$207 | +\$29 | +\$189 | |
| | INVL182446Q-HD | 49 3/8" | 18" | 24" | \$1975 | +\$219 | +\$29 | +\$200 | |
| | left-handed hinged door | | | | | | | | |
| | INVR121846Q-HD | 49 3/8" | 12" | 18" | \$1683 | +\$187 | +\$29 | +\$171 | |
| | INVR122446Q-HD | 49 3/8" | 12" | 24" | \$1774 | +\$197 | +\$29 | +\$180 | |
| | INVR151846Q-HD | 49 3/8" | 15" | 18" | \$1774 | +\$197 | +\$29 | +\$180 | |
| | INVR152446Q-HD | 49 3/8" | 15" | 24" | \$1871 | +\$207 | +\$29 | +\$189 | |
| | INVR181846Q-HD | 49 3/8" | 18" | 18" | \$1871 | +\$207 | +\$29 | +\$189 | |
| INVR182446Q-HD | 49 3/8" | 18" | 24" | \$1975 | +\$219 | +\$29 | +\$200 | | |
| right-handed hinged door (illustrated) | | | | | | | | | |

- Option of mitten shelf with coat rod or shelves
- Use flat glides to match frame heights noted in descriptions
- Adding rectangular glides increases exterior height
- Consult General Information for pull options
- Nuform Classic and Select colors available
- Optional shelves or coat rod with shelf can be selected

NOTES

Nuform Wardrobes are available with an eLock option. Add \$411 to list price for eLock.

eLocks come in two styles: Dead Bolt style or Slam style

There are two eLock types: Multi-use or Single-use

In order to get a total cost on products when upcharges are present take the list price of the product number and add the upcharge cost shown to the list price.

For example:

Product INVR121852Q-HD with Rectangular Glides would be \$1829 +\$33

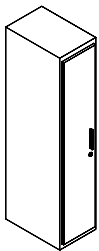

Nuform Wardrobe Tower to match 57" h panel

eLock option available

| Part number | H | W | D | Flat & Round Glides | | Rectangular glides | Accent paint |
|--|---------|-----|-----|-------------------------------|------------------------------|--------------------|--------------|
| | | | | Nuform classic/ Neutral paint | Nuform select/ Neutral paint | | |
| INVL121852Q-HD | 55 3/8" | 12" | 18" | \$1829 | +\$202 | +\$29 | +\$185 |
| INVL122452Q-HD | 55 3/8" | 12" | 24" | \$1892 | +\$209 | +\$29 | +\$192 |
| INVL151852Q-HD | 55 3/8" | 15" | 18" | \$1892 | +\$209 | +\$29 | +\$192 |
| INVL152452Q-HD | 55 3/8" | 15" | 24" | \$1956 | +\$216 | +\$29 | +\$198 |
| INVL181852Q-HD | 55 3/8" | 18" | 18" | \$1956 | +\$216 | +\$29 | +\$198 |
| INVL182452Q-HD | 55 3/8" | 18" | 24" | \$2023 | +\$223 | +\$29 | +\$205 |
| left-handed hinged door | | | | | | | |
| INVR121852Q-HD | 55 3/8" | 12" | 18" | \$1829 | +\$202 | +\$29 | +\$185 |
| INVR122452Q-HD | 55 3/8" | 12" | 24" | \$1892 | +\$209 | +\$29 | +\$192 |
| INVR151852Q-HD | 55 3/8" | 15" | 18" | \$1892 | +\$209 | +\$29 | +\$192 |
| INVR152452Q-HD | 55 3/8" | 15" | 24" | \$1956 | +\$216 | +\$29 | +\$198 |
| INVR181852Q-HD | 55 3/8" | 18" | 18" | \$1956 | +\$216 | +\$29 | +\$198 |
| INVR182452Q-HD | 55 3/8" | 18" | 24" | \$2023 | +\$223 | +\$29 | +\$205 |
| right-handed hinged door (illustrated) | | | | | | | |

- Option of mitten shelf with coat rod or shelves
- Use flat glides to match frame heights noted in descriptions
- Adding rectangular glides increases exterior height
- Consult General Information for pull options
- Nuform Classic and Select options available

NOTES

Nuform Wardrobes are available with an eLock option. Add \$411 to list price for eLock.

eLocks come in two styles: Dead Bolt style or Slam style

There are two eLock types: Multi-use or Single-use

In order to get a total cost on products when upcharges are present take the list price of the product number and add the upcharge cost shown to the list price.

For example:

Product INVR121860Q-HD with Rectangular Glides would be \$1868 +\$33

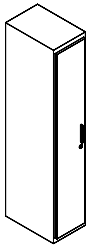

Nuform Wardrobe Tower to match 64" h panel

eLock option available

| Part number | H | W | D | Flat & Round Glides | | Rectangular glides | Accent paint |
|--|---------|-----|-----|-------------------------------|------------------------------|--------------------|--------------|
| | | | | Nuform classic/ Neutral paint | Nuform select/ Neutral paint | | |
| INVL121860Q-HD | 62 7/8" | 12" | 18" | \$1868 | +\$207 | +\$29 | +\$189 |
| INVL122460Q-HD | 62 7/8" | 12" | 24" | \$1975 | +\$219 | +\$29 | +\$200 |
| INVL151860Q-HD | 62 7/8" | 15" | 18" | \$1975 | +\$219 | +\$29 | +\$200 |
| INVL152460Q-HD | 62 7/8" | 15" | 24" | \$2031 | +\$225 | +\$29 | +\$206 |
| INVL181860Q-HD | 62 7/8" | 18" | 18" | \$2031 | +\$225 | +\$29 | +\$206 |
| INVL182460Q-HD | 62 7/8" | 18" | 24" | \$2086 | +\$232 | +\$29 | +\$211 |
| left-handed hinged door | | | | | | | |
| INVR121860Q-HD | 62 7/8" | 12" | 18" | \$1868 | +\$207 | +\$29 | +\$189 |
| INVR122460Q-HD | 62 7/8" | 12" | 24" | \$1975 | +\$219 | +\$29 | +\$200 |
| INVR151860Q-HD | 62 7/8" | 15" | 18" | \$1975 | +\$219 | +\$29 | +\$200 |
| INVR152460Q-HD | 62 7/8" | 15" | 24" | \$2031 | +\$225 | +\$29 | +\$206 |
| INVR181860Q-HD | 62 7/8" | 18" | 18" | \$2031 | +\$225 | +\$29 | +\$206 |
| INVR182460Q-HD | 62 7/8" | 18" | 24" | \$2086 | +\$232 | +\$29 | +\$211 |
| right-handed hinged door (illustrated) | | | | | | | |

OVERHEAD STORAGE BINS

Overhead storage bins may be panel mounted on or off module as well as wall mounted. Overhead bins are fabricated from minimum 20 gauge steel with horizontal reinforcing channels. Task lights and bin-mounted sorters are easily installed beneath bins without tools. Bins are available in 6" increments from 24" to 48" W. General maximum recommended load for overhead bins is 3lbs per linear inch. Bins are finished in standard 37.5° gloss baked enamel, electrostatically applied in a 2-coat process and are available in all colors shown in the Inscape color guide.

Overhead bins are 13 3/8" deep and have lift-up flipper doors that glide on ball bearing slides. Soft-down bins feature a soft-down mechanism that slows the speed at which the overhead doors close. Bins are available with and without locks. The lock mechanism engages both sides of the overhead case to prevent forcible entry. Standard and soft-down overhead bins may be specified with Nuform fronts. Nuform fronts are available in any of Inscape's standard finishes.

OVERHEAD BIN BRACKETS

Overhead bin brackets are finished in black and mount into the panel upright for on module bracket or utilize special brackets for off-module condition. Off-module brackets are specific to frame thickness. Specific Overhead Bin brackets are required for mounting onto a 44" and 57" H frame as well as 6.75" and 20.25" H stack-ons (on module).



| On module bracket | Off-module |
|--|---|
| Both brackets attach into upright slots on upright | Both brackets are mounted off module only |
| Does not require tile behind | Must be further than 5/16" from module line |
| | Requires tile behind |

ALIGNMENT BRACKETS

Alignment brackets are required if overhead storage units are mounted bin-to-bin or bin-to-shelf or shelf-to-shelf. One bracket is required.

TWIN-BINS

Twin-bins are 5.75" deep on each side of the supporting frame. Twin-Bins may be specified to install in both the lower and upper position of the frame. Bins are manufactured from minimum 20 gauge steel with an extruded aluminum reinforced top. Double wall, sliding doors on each side of the unit, slide easily across the recessed groove built into the bin front. Twin-Bins are available with or without locks. The locking mechanism is individualized for each side of the unit, allowing for personal privacy on either side. Twin-Bins are available in 36", 42", 48" and 60" widths. Recommended maximum load for Twin-Bins is 3lbs per linear inch. Bins are finished in standard 37.5° gloss baked enamel, electrostatically applied in a 2-coat process and are available in any of the colors shown in our Color Guide. Woodgrain fronts are available in any of our standard woodgrain finishes.

Handles are standard in aluminum finish and are located on the front of the sliding door. Case may still be ordered in any of the colors shown in our Color Guide.

ELECTRIFIED TWIN BIN

The electrified twin bin is built on the same premise as the standard Twin Bin with the addition of electrical and a sliding door with locking capabilities in two positions. All electrical components are specified separately including power track, receptacles and jumper cables. The sliding door may lock either the binder storage portion (full depth of bin) or the electrified portion which is the center portion which is approximately 5" D. The back of the Electrified Twin Bin may be clad with either a tackboard or whiteboard which are both specific to this storage unit. A shelf may also be optioned for the electrified portion which is field installed midway between top and bottom of opening. A gap in the shelf allows for the cord of an electronic unit to plug into duplex (located near base of opening) and still sit on top of shelf.

NOTE: these accessories are NOT compatible with the standard Twin Bin. See Application Guide for more details.

Specify Twin-Bin mounting brackets separately according to location on frame. 1 bracket per Twin-Bin is required. Specify 13.5" high bottom tiles when lower position mounting bracket is specified. When stacking Twin-Bins a 6.75" high tile minimum must separate the two. Do not specify over Power Track Kit. Twin-Bins specified with 44" H frames cannot be used above a worksurface. It is not recommended to specify Twin-Bins on wing panels. Twin-Bins should only be specified on spine panels for adequate stability.

OVERHEAD SHELVES

Overhead Shelves may be panel-mounted both on and off-module or wall-mounted. Shelves are manufactured from minimum 20 gauge steel. Shelves are 13.75" deep.

Task lights and shelf-mounted sorters may easily be installed beneath panel-mounted shelves without tools. General maximum recommended load for overhead shelves is 3 lbs. per linear inch. Shelves are finished in standard 37.5° gloss baked enamel, electrostatically applied in a 2-coat process.

OVERHEAD SHELF BRACKETS

Overhead Shelf Brackets are specified to mount shelf on or off-module to the frame. The on-module bracket may be used with either thickness of panel. If a shelf is desired in an off-module condition a special bracket is required. Wall mount brackets are also available. Drywall mounting brackets do not include fasteners. The installer must ensure the surface is adequately constructed and/or braced and that adequate fasteners are used to ensure a secure installation.

UP-MOUNT BIN

The Up-Mount Bin is constructed of 24 gauge steel on the back and 20 gauge steel on bottom, sides and top. The Up-Mount Bin is ordered and shipped independent of the stanchion kit, top trim and accessories to hang on back of bin. The stanchion kit includes hardware to mount the stanchions on the crossrail of the frame and top trim (tapered or flat). Stanchion kits are specified based on thickness of frame in which the Up-Mount Bin is being installed. The backs of all Up-Mount Bins require either a whiteboard or a tackboard to provide a clean aesthetic. These accessories are specific to the Up-Mount Bin and include mounting hardware. The stanchion and Up-Mount Bin provide an overall height of 20.25" module matching adjacent panel heights. The bin is 12.75" deep and may be specified directly adjacent to another Up-Mount Bin facing the opposite direction; creating a "Twin-Bin" effect. Separate top cap and two stanchions will be required for each bin.

The Up-Mount Bin has the option to also be mounted on either thickness of frame like a traditional bin. When this option is selected covers will be included to hide the bracket hooks.

LOCKS

Standard with single bitted lock. If lock is not required add suffix '**NL**' after product number and deduct \$57 list per lock. For applications requiring higher security a double bitted solution is available. Random keying is standard, and keyed alike may be ordered. Master keys are available; refer to the accessories section to specify.

Cabinets originally ordered as non-locking may be field installed with the addition of locking bars and a lock core. Contact your client services representative for required parts.

Locks feature removable core and are standard with two keys, one of which has a black neoprene plastic key cover. Locks may be ordered for field installation. Specify cabinet height and width or model number.



Note: Locks cannot be field installed on hinged door cabinets.

FINISHES

All overhead units are finished in standard 36.5° gloss baked enamel, electrostatically applied in a 2-coat process. Refer to the surface materials section for available colors. With the exception of custom micas, whites and metallic; custom colors are available at an up-charge and are subject to extended lead times. All interior drawers/ shelf bodies, exposed hardware (excluding European style hinges) hang file bars, dividers and media frames are finished in Eco Black.

FRONT DETAILS & PULL OPTIONS

9900 Series fronts have full width integral pulls with enamel finish to match case fronts. Storage with Handles is single-wall construction. Refer to the images and chart below for pull application on Storage with Handles and Nuform fronts.

| Pull | Storage with Handles | Nuform |
|---|----------------------|--------|
|  FP001 P290 Aluminum Leaf Finish | ● | ● |
|  FP004 Brushed Nickel Finish | ● | ● |
|  FP005 Brushed Nickel Finish | ● | ○ |





● Available ○ Unavailable

Pulls FP004 and FP005 meet the guidelines for ADA compliance.

FP005 is the default pull for Storage with Handles

FP001 is the default pull for Nuform

- Bracket ordered separately
- Ensure the wall is braced to accept the weight of a loaded overhead unit
- On module and aff module mounting options available
- Consult General Information for pull options
- Nuform Classic and Select options available
- Cannot span tiles below overhead bins

| | | Part number | H | W | Wt (lbs) | Nuform classic/ neutral paint/ base price | Nuform select | Accent paint |
|---|---|-------------------|-----|-----|----------|---|------------------|-----------------|
|  | Storage with Handles Standard Overhead Bin | INPHHB24 | 14" | 24" | 34 | \$469 | — | +\$50 |
| | | INPHHB30 | 14" | 30" | 40 | \$480 | — | +\$51 |
| | | INPHHB36 | 14" | 36" | 46 | \$493 | — | +\$52 |
| | | INPHHB42 | 14" | 42" | 52 | \$523 | — | +\$54 |
| | | INPHHB48 | 14" | 48" | 58 | \$550 | — | +\$58 |
|  | 9900 Series Front Standard Overhead Bin | INPHEB24 | 14" | 24" | 34 | \$550 | — | +\$58 |
| | | INPHEB30 | 14" | 30" | 40 | \$564 | — | +\$59 |
| | | INPHEB36 | 14" | 36" | 46 | \$579 | — | +\$60 |
| | | INPHEB42 | 14" | 42" | 52 | \$612 | — | +\$63 |
| | | INPHEB48 | 14" | 48" | 58 | \$648 | — | +\$66 |
|  | 9900 Series Front Soft- Down Overhead Bin | INPHEB24SD | 14" | 24" | 34 | \$678 | — | +\$70 |
| | | INPHEB30SD | 14" | 30" | 40 | \$687 | — | +\$70 |
| | | INPHEB36SD | 14" | 36" | 46 | \$712 | — | +\$72 |
| | | INPHEB42SD | 14" | 42" | 52 | \$753 | — | +\$77 |
| | | INPHEB48SD | 14" | 48" | 58 | \$794 | — | +\$84 |
|  | Nuform Front Standard Overhead Bin | INPHQB24 | 14" | 24" | 34 | \$783 | +\$88 | +\$83 |
| | | INPHQB30 | 14" | 30" | 40 | \$795 | +\$89 | +\$84 |
| | | INPHQB36 | 14" | 36" | 46 | \$822 | +\$92 | +\$86 |
| | | INPHQB42 | 14" | 42" | 52 | \$870 | +\$97 | +\$90 |
| | | INPHQB48 | 14" | 48" | 58 | \$915 | +\$102 | +\$94 |
|  | Nuform Front Soft-Down Overhead Bin | INPHQB24SD | 14" | 24" | 34 | \$829 | +\$92 | +\$87 |
| | | INPHQB30SD | 14" | 30" | 40 | \$858 | +\$96 | +\$89 |
| | | INPHQB36SD | 14" | 36" | 46 | \$885 | +\$99 | +\$91 |
| | | INPHQB42SD | 14" | 42" | 52 | \$913 | +\$102 | +\$94 |
| | | INPHQB48SD | 14" | 48" | 58 | \$943 | +\$105 | +\$97 |

- Bracket ordered separately
- Hinged door bin is for wall mounted application only
- Hinged Door Bin options Nuform and laminate come with a lock. Options glass and acrylic do not.
- Hinged door bins have a door that extends down a little bit below the bin so that it acts like a handle. No face mounted handle is required.
- Up-Mount Bin may be installed on a wall or panel using wall or panel brackets
- If the option to panel mount the Up-Mount Bin is selected cover will be included to hide the bracket hooks
- Optional colored insert available for Up-Mount bin only. See accessories section
- Optional top available for Up-mount bin only. See accessories section
- When the Up-Mount Bin is being mounted on a wall, the optional Flush Mount Kit can be installed on the bottom side of the bin to cover understructure typically used for stanchion mount. 54" and 60" Up-Mount Bins do not have this as a standard option.
- The Flush Mount Kit is not to be used when stanchion mounting to the bin
- Ensure the wall is braced to accept the weight of a loaded overhead unit

LOCK OPTION

Hinged Door Overhead Bins come standard with lock. If lock is not required as suffix"/NL" after product number. Deduct \$57 list per lock.

NOTES

Up-Mount Bins MUST always be specified to include a tack board or whiteboard specific to the up-mount bin width when installed on stanchion, as they cover holes on the back of the bin. See accessories section

If selecting the panel mounted option for the Up-Mount Bin, add \$108 list per bin.

In order to get a total cost on products when upcharges are present take the list price of the product number and add the upcharge cost shown to the list price.

For example:

Product INWMBHG24 in Grade 1 laminate would be \$1101 +\$355

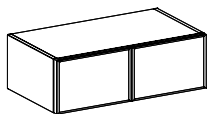





Hinged Door Bin

| Part number | H | W | Nuform/ laminate/ base price | Grade 1 laminate | Pure white glass | Frosted acrylic | Flush bottom required | Accent paint |
|------------------|-----|-----|------------------------------------|---------------------|---------------------|--------------------|-----------------------------|-----------------|
| INWMBHG24 | 14" | 24" | \$1101 | +\$355 | +\$469 | +\$382 | +\$112 | +\$112 |
| INWMBHG30 | 14" | 30" | \$1161 | +\$373 | +\$515 | +\$411 | +\$116 | +\$119 |

| | Part number | H | W | Neutral paint/ base price | Flush bottom required | Accent paint |
|--------------|------------------|-----|-----|------------------------------|--------------------------|-----------------|
| Up-Mount Bin | INPHUMB24 | 14" | 24" | \$636 | +\$112 | +\$65 |
| | INPHUMB30 | 14" | 30" | \$657 | +\$116 | +\$67 |
| | INPHUMB36 | 14" | 36" | \$677 | +\$120 | +\$69 |
| | INPHUMB42 | 14" | 42" | \$709 | +\$128 | +\$72 |
| | INPHUMB48 | 14" | 48" | \$724 | +\$134 | +\$74 |
| | INPHUMB54 | 14" | 54" | \$755 | — | +\$77 |
| | INPHUMB60 | 14" | 60" | \$829 | — | +\$87 |



- Brackets are for use with both standard and soft-down bins
- On-module and off module brackets are black and ship as pairs
- Off-module brackets must be situated so both sides are off module on the frame (min 5/16" from module line)
- Wall mount bracket available in standard paint colors
- Alignment bracket must be specified when any overhead unit is specified adjacent to another
- "2F" denotes use with 2 3/4" thick frame
- "3F" denotes use with 3 1/2" thick frame
- Specific Overhead Bin brackets are required for mounting onto a 44" and 57" H frame as well as 6.75" and 20.25" H stack-ons (on module)





| | Part number | W | Wt (lbs) | Neutral paint/ base price | Accent paint | |
|---|---------------------------------|--------------------|----------|------------------------------|-----------------|-------|
|  | On Module Overhead Bin Bracket | INBBKT | — | 0.2 | \$56 | — |
| | | INBBKT-4457 | — | 0.2 | \$56 | — |
| for use with 44" H & 57" H frames | | | | | | |
|  | Off Module Overhead Bin Bracket | INOFBBKT-3F | — | 0.2 | \$160 | — |
| | For use with 3 1/2" T frames | | | | | |
|  | Off Module Overhead Bin Bracket | INOFBBKT-2F | — | 0.2 | \$160 | — |
| | For use with 2 3/4" T frames | | | | | |
|  | Alignment Bracket (pair) | INAB | — | 0.1 | \$17 | — |
|  | Wall Mounted Bin Bracket | INWMBBKT-24 | 24" | 2 | \$263 | +\$29 |
| | | INWMBBKT-30 | 30" | 5 | \$265 | +\$29 |
| | | INWMBBKT-36 | 36" | 5 | \$267 | +\$29 |
| | | INWMBBKT-42 | 42" | 6 | \$276 | +\$30 |
| | | INWMBBKT-48 | 48" | 6 | \$279 | +\$30 |

Storage





Overhead Storage Up-Mount Bin Supports and Brackets

System

- Up-mount bins stanchions must be specified to support a frame mounted up-mount bin
- Top caps included with stanchion kits and are specified to match frame and bin width
- Stanchions are specific to the Inscape System frame and can not be used with Bench
- "2F" denotes use with 2 3/4" thick frame
- "3F" denotes use with 3 1/2" thick frame
- Specific Overhead Bin brackets are required for mounting onto a 44" and 57" H frame as well as 6.75" and 20.25" H stack-ons (on module)

| | Part number | H | W | Wt (lbs) | Neutral paint/ base price | Accent paint | |
|---|---|-----------------------------------|----------|----------|------------------------------|-----------------|-------|
|  | Stanchion Kit for Up-Mount Bins | INUBSTNKT24-3F | 5 1/4" | 24" | — | \$355 | +\$37 |
| | For use with 3 1/2" T frames | INUBSTNKT30-3F | 5 1/4" | 30" | — | \$367 | +\$39 |
| | | INUBSTNKT36-3F | 5 1/4" | 36" | — | \$375 | +\$42 |
| | | INUBSTNKT42-3F | 5 1/4" | 42" | — | \$386 | +\$42 |
| | | INUBSTNKT48-3F | 5 1/4" | 48" | — | \$394 | +\$43 |
| | | INUBSTNKT54-3F | 5 1/4" | 54" | — | \$405 | +\$44 |
| | | INUBSTNKT60-3F | 5 1/4" | 60" | — | \$417 | +\$45 |
|  | Stanchion Kit for Up-Mount Bins | INUBSTNKT24-2F | 5 1/4" | 24" | — | \$355 | +\$37 |
| | For use with 2 3/4" T frames | INUBSTNKT30-2F | 5 1/4" | 30" | — | \$367 | +\$39 |
| | | INUBSTNKT36-2F | 5 1/4" | 36" | — | \$375 | +\$42 |
| | | INUBSTNKT42-2F | 5 1/4" | 42" | — | \$386 | +\$42 |
| | | INUBSTNKT48-2F | 5 1/4" | 48" | — | \$394 | +\$43 |
| | | INUBSTNKT54-2F | 5 1/4" | 54" | — | \$405 | +\$44 |
| | | INUBSTNKT60-2F | 5 1/4" | 60" | — | \$417 | +\$45 |
| | Part number | W | Wt (lbs) | | | List price | |
|  | On Module Overhead Bin Bracket | INBBKTUP-3F | — | 0.2 | | \$56 | |
| | For use with the Up-Mount Bin on a 3 1/2" T frame | INBBKTUP-3F4457 | — | 0.2 | | \$56 | |
| | | for use with 44" H & 57" H frames | | | | | |
|  | On Module Overhead Bin Bracket | INBBKT | — | 0.2 | | \$56 | |
| | For use with the Up-Mount Bin on a 2 3/4" T frame | INBBKT-4457 | — | 0.2 | | \$56 | |
| | | for use with 44" H & 57" H frames | | | | | |
|  | Alignment Bracket (pair) | INAB | — | 0.1 | | \$17 | |

- On-module brackets are painted and ship as pairs
- "2F" denotes use with 2 3/4" thick frame
"3F" denotes use with 3 1/2" thick frame
- Alignment bracket must be specified when any shelf is specified adjacent to another

| | Part number | H | W | Wt (lbs) | Neutral paint/ base price | Accent paint | |
|---|---|------------------|---|----------|------------------------------|-----------------|-------|
|  | 13 3/8" D Standard Shelf | INPS1324 | — | 24" | 4 | \$72 | +\$11 |
| | | INPS1330 | — | 30" | 6 | \$88 | +\$12 |
| | | INPS1336 | — | 36" | 8 | \$92 | +\$12 |
| | | INPS1342 | — | 42" | 10 | \$99 | +\$13 |
| | | INPS1348 | — | 48" | 12 | \$103 | +\$13 |
| | | INPS1354 | — | 54" | 14 | \$119 | +\$15 |
| | | INPS1360 | — | 60" | 16 | \$128 | +\$16 |
|  | On Module Standard Shelf Bracket For use with 3 1/2" T frames | INSB13-3F | — | — | 3 | \$146 | +\$18 |
| | | | | | | | |
|  | On Module Standard Shelf Bracket For use with 2 3/4" T frames | INSB13-2F | — | — | 3 | \$146 | +\$18 |
| | | | | | | | |
|  | Wall Mount Standard Shelf Bracket | INSB1324W | — | 24" | 7 | \$305 | +\$33 |
| | | INSB1330W | — | 30" | 8 | \$310 | +\$33 |
| | | INSB1336W | — | 36" | 8 | \$315 | +\$33 |
| | | INSB1342W | — | 42" | 9 | \$319 | +\$34 |
| | | INSB1348W | — | 48" | 9 | \$323 | +\$34 |
|  | Alignment Bracket (pair) | INAB | — | — | 0.1 | \$17 | — |

- Up-mount overhead bins MUST always be specified to include a tackboard or whiteboard specific to the up-mount bin width (cover holes in back) when mounted on stantions
- Overhead bin top is an optional aesthetic
- ¾" top is installation ready, complete with double sided tape for adhesion to case

NOTE

Only Expo Markers are to be used on any Inscape Whiteboard. Whiteboards should be cleaned with Expo Eraser or a Microfiber cleaning cloth along with Expo Cleaning Solution which is formulated to remove residue from Expo Dry Erase Markers.

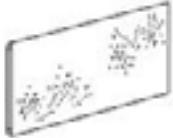

| | | Part number | H | W | Wt (lbs) | Neutral paint/ base price | Accent paint |
|---|---|--------------------|-------|-----|----------|------------------------------|-----------------|
|  | Colored Insert for back of bin For Up-Mounted bin only | IN12INSRT24 | 12 ½" | 24" | — | \$104 | +\$13 |
| | | IN12INSRT30 | 12 ½" | 30" | — | \$108 | +\$15 |
| | | IN12INSRT36 | 12 ½" | 36" | — | \$116 | +\$15 |
| | | IN12INSRT42 | 12 ½" | 42" | — | \$121 | +\$16 |
| | | IN12INSRT48 | 12 ½" | 48" | — | \$128 | +\$16 |

| | | Part number | H | W | Wt (lbs) | Neutral paint/ base price | Accent paint |
|--|-------------------------|--------------------|-----|-----|----------|------------------------------|-----------------|
|  | Up-Mount Bin Whiteboard | INUBWHB1424 | 14" | 24" | — | \$45 | — |
| | | INUBWHB1430 | 14" | 30" | — | \$48 | — |
| | | INUBWHB1436 | 14" | 36" | — | \$52 | — |
| | | INUBWHB1442 | 14" | 42" | — | \$59 | — |
| | | INUBWHB1448 | 14" | 48" | — | \$65 | — |
| | | INUBWHB1454 | 14" | 54" | — | \$74 | — |
| | | INUBWHB1460 | 14" | 60" | — | \$77 | — |

| | Part number | H | W | Grade 1/ COM/ base price | Grade 2 | Grade 3 | Grade 4 | Grade 5 | Grade 6 | Grade 7 | Grade 8 |
|---|--------------------|-----|-----|--------------------------------|---------|---------|---------|---------|---------|---------|---------|
|  | INUBTAC1424 | 14" | 24" | \$171 | +\$8 | +\$12 | — | +\$29 | — | +\$74 | — |
| | INUBTAC1430 | 14" | 30" | \$195 | +\$7 | +\$12 | — | +\$29 | — | +\$77 | — |
| | INUBTAC1436 | 14" | 36" | \$198 | +\$12 | +\$22 | — | +\$44 | — | +\$103 | — |
| | INUBTAC1442 | 14" | 42" | \$204 | +\$13 | +\$23 | — | +\$45 | — | +\$106 | — |
| | INUBTAC1448 | 14" | 48" | \$209 | +\$13 | +\$23 | — | +\$48 | — | +\$115 | — |
| | INUBTAC1454 | 14" | 54" | \$212 | +\$12 | +\$25 | — | +\$47 | — | +\$114 | — |
| | INUBTAC1460 | 14" | 60" | \$219 | +\$10 | +\$22 | — | +\$46 | — | +\$114 | — |

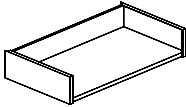

| | Part number | W | D | Nuform classic/ base price | Nuform select pattern |
|---|----------------------|-----|-----|-------------------------------|--------------------------|
|  | PHUMBTOP-1324 | 24" | 13" | \$159 | +\$20 |
| | PHUMBTOP-1330 | 30" | 13" | \$187 | +\$20 |
| | PHUMBTOP-1336 | 36" | 13" | \$221 | +\$17 |
| | PHUMBTOP-1342 | 42" | 13" | \$245 | +\$27 |
| | PHUMBTOP-1348 | 48" | 13" | \$272 | +\$30 |
| | PHUMBTOP-1354 | 54" | 13" | \$299 | +\$31 |
| | PHUMBTOP-1360 | 60" | 13" | \$327 | +\$34 |
| | PHUMBTOP-1372 | 72" | 13" | \$429 | +\$45 |
| | PHUMBTOP-1384 | 84" | 13" | \$479 | +\$48 |
| | PHUMBTOP-1396 | 96" | 13" | \$526 | +\$54 |

- Up-Mount shelf mounts below the Up-Mount Bin on module
- Wall mount bracket available in standard paint colors
- Sliding door must be mounted on two up-mount bins of equal size that are side by side

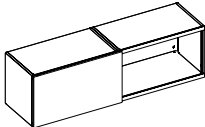





| | Part number | H | W | Wt (lbs) | Neutral paint/ base price | Accent paint |
|--|--------------------------|--------|-----|----------|------------------------------|-----------------|
|  | Up-Mount Bin shelf | | | | | |
| | INUMBSH24 | 4 1/8" | 24" | — | \$304 | +\$32 |
| | INUMBSH30 | 4 1/8" | 30" | — | \$310 | +\$33 |
| | INUMBSH36 | 4 1/8" | 36" | — | \$315 | +\$33 |
| | INUMBSH42 | 4 1/8" | 42" | — | \$344 | +\$36 |
| | INUMBSH48 | 4 1/8" | 48" | — | \$355 | +\$37 |
|  | Wall Mounted Bin Bracket | | | | | |
| | INWMBBKT-24 | — | 24" | 2 | \$263 | +\$29 |
| | INWMBBKT-30 | — | 30" | 5 | \$265 | +\$29 |
| | INWMBBKT-36 | — | 36" | 5 | \$267 | +\$29 |
| | INWMBBKT-42 | — | 42" | 6 | \$276 | +\$30 |
| | INWMBBKT-48 | — | 48" | 6 | \$279 | +\$30 |

| | Part number | W | Nufrom classic/ laminated/ base price | Nufrom select | Grade 1 laminated | Glass | Frosted acrylic |
|---|--|-----|--|------------------|----------------------|-------|--------------------|
|  | Sliding Door & Track Up-Mount bin specified separately | | | | | | |
| | INUMBSLDR24 | 24" | \$441 | +\$50 | +\$142 | +400 | +\$341 |
| | INUMBSLDR30 | 30" | \$564 | +\$63 | +\$182 | +428 | +\$306 |
| | INUMBSLDR36 | 36" | \$580 | +\$65 | +\$187 | +522 | +\$376 |
| | INUMBSLDR42 | 42" | \$589 | +\$66 | +\$191 | +625 | +\$453 |
| | INUMBSLDR48 | 48" | \$605 | +\$67 | +\$196 | +720 | +\$522 |

- Requires a 13.5" opening within either thickness of frame
- Twin-Bin cannot be installed directly above a worksurface as it causes interference
- Twin-Bin brackets are quoted separately and are specific to panel thickness
- Cannot span tiles below twin-bins
- Upperdeck electrical cannot be installed directly below a twin-bin
- Jumper cables and receptacles for the Electrified Twin Bin power track specified separately
- The "IN3D_UD-8" receptacles are to be specified in conjunction with the Electrified Twin-Bin

| | Part number | H | W | Wt (lbs) | Nuform classic/ neutral paint/ base price | Nuform select | Accent paint | |
|---|-----------------------------------|-------------------|-----|----------|---|------------------|-----------------|--------|
|  | Nuform Front Twin-Bin | INTWQB36LH | 14" | 36" | 42 | \$1449 | +\$161 | +\$146 |
| | | INTWQB42LH | 14" | 42" | 52 | \$1506 | +\$167 | +\$153 |
| | | INTWQB48LH | 14" | 48" | 58 | \$1558 | +\$172 | +\$159 |
| | | INTWQB54LH | 14" | 54" | 62 | \$1576 | +\$174 | +\$161 |
| | | INTWQB60LH | 14" | 60" | 68 | \$1593 | +\$177 | +\$162 |
|  | Nuform Front Electrified Twin-Bin | INETWBQ36 | 14" | 36" | 42 | \$1886 | +\$209 | +\$191 |
| | | INETWBQ42 | 14" | 42" | 52 | \$1975 | +\$219 | +\$200 |
| | | INETWBQ48 | 14" | 48" | 58 | \$2024 | +\$225 | +\$205 |
| | | INETWBQ54 | 14" | 54" | 62 | \$2048 | +\$227 | +\$207 |
| | | INETWBQ60 | 14" | 60" | 68 | \$2071 | +\$229 | +\$209 |

- The mid and lower brackets include crossrails which are required for installation of Twin-Bin
- Frame crossrail is required to be cut on site to install the mid Twin-Bin bracket
- See Inscape System Application Guide for bracket details and locations
- Twin-Bin brackets are specific to frame thickness
- "2F" denotes use with 2.75" thick frame,
"3F" denotes use with 3.5" thick frame

| | | Part number | H | W | Wt (lbs) | List price |
|---|--|------------------------|---|-----|----------|------------|
|  | Upper Twin-Bin Bracket For use with 3 1/2" T frames | INTWBKT-U-3F | — | — | 0.4 | \$114 |
|  | Mid Twin-Bin Bracket For use with 3 1/2" T frames | INTWBKTUH-36-3F | — | 36" | — | \$178 |
| | | INTWBKTUH-42-3F | — | 42" | — | \$180 |
| | | INTWBKTUH-48-3F | — | 48" | — | \$183 |
| | | INTWBKTUH-54-3F | — | 54" | — | \$185 |
| | | INTWBKTUH-60-3F | — | 60" | — | \$188 |
|  | Lower Twin-Bin Bracket For use with 3 1/2" T frames | INTWBKT-B-36-3F | — | 36" | — | \$178 |
| | | INTWBKT-B-42-3F | — | 42" | — | \$180 |
| | | INTWBKT-B-48-3F | — | 48" | — | \$183 |
| | | INTWBKT-B-54-3F | — | 54" | — | \$185 |
| | | INTWBKT-B-60-3F | — | 60" | — | \$188 |
|  | Upper Twin-Bin Bracket For use with 2 3/4" T frames | INTWBKT-U-2F | — | — | 0.4 | \$114 |
|  | Mid Twin-Bin Bracket For use with 2 3/4" T frames | INTWBKTUH-36-2F | — | 36" | — | \$178 |
| | | INTWBKTUH-42-2F | — | 42" | — | \$180 |
| | | INTWBKTUH-48-2F | — | 48" | — | \$183 |
| | | INTWBKTUH-54-2F | — | 54" | — | \$185 |
| | | INTWBKTUH-60-2F | — | 60" | — | \$188 |
|  | Lower Twin-Bin Bracket For use with 2 3/4" T frames | INTWBKT-B-36-2F | — | 36" | — | \$178 |
| | | INTWBKT-B-42-2F | — | 42" | — | \$180 |
| | | INTWBKT-B-48-2F | — | 48" | — | \$183 |
| | | INTWBKT-B-54-2F | — | 54" | — | \$185 |
| | | INTWBKT-B-60-2F | — | 60" | — | \$188 |

- Electrified Twin Bin shelf is installed in opening where electrical is located (center)
- Electrified Twin Bin Whiteboard + Tackboard only compatible with Electrified Twin Bin
- Receptacles are available in color options of black (default), white and gray
- White close match to 168 Glacier White and Gray close match to 290 – Aluminum Leaf
- The circuit 3 receptacle requires 2+2 or 3+1 wire designation ("4" in the code signifies 3+1 compatibility)
- USB power modules can be used with the Electrified Twin-Bin

NOTE

Only Expo Markers are to be used on any Inscape Whiteboard. Whiteboards should be cleaned with Expo Eraser or a Microfiber cleaning cloth along with Expo Cleaning Solution which is formulated to remove residue from Expo Dry Erase Markers.

| Part number | H | W | Grade 1/ COM/ base price | Grade 2 | Grade 3 | Grade 4 | Grade 5 | Grade 6 | Grade 7 | Grade 8 |
|---|-----|-----|--------------------------------|---------|---------|---------|---------|---------|---------|---------|
|  INTWBTB-12 | 14" | 12" | \$130 | +\$8 | +\$16 | — | +\$29 | — | +\$74 | — |
| INTWBTB-14 | 14" | 14" | \$133 | +\$8 | +\$16 | — | +\$29 | — | +\$74 | — |
| INTWBTB-16 | 14" | 16" | \$139 | +\$8 | +\$16 | — | +\$29 | — | +\$74 | — |
| INTWBTB-18 | 14" | 18" | \$145 | +\$8 | +\$16 | — | +\$29 | — | +\$74 | — |
| INTWBTB-20 | 14" | 20" | \$159 | +\$8 | +\$16 | — | +\$29 | — | +\$74 | — |

Electrified Twin-Bin Tackboard

| Part number | H | W | Wt (lbs) | Neutral paint/ base price | Accent paint | |
|--|---------------------|---|----------|------------------------------|--------------|-------|
|  Electrified Twin-Bin Shelf | INETWBSHF-12 | — | 12" | — | \$105 | +\$13 |
| | INETWBSHF-14 | — | 14" | — | \$105 | +\$13 |
| | INETWBSHF-16 | — | 16" | — | \$105 | +\$13 |
| | INETWBSHF-18 | — | 18" | — | \$105 | +\$13 |
| | INETWBSHF-20 | — | 20" | — | \$105 | +\$13 |

| | | | | | | |
|---|-------------------|-----|-----|---|------|---|
|  Electrified Twin-Bin Whiteboard | INTWBWB-12 | 14" | 12" | — | \$39 | — |
| | INTWBWB-14 | 14" | 14" | — | \$39 | — |
| | INTWBWB-16 | 14" | 16" | — | \$39 | — |
| | INTWBWB-18 | 14" | 18" | — | \$45 | — |
| | INTWBWB-20 | 14" | 20" | — | \$45 | — |

| | | | | | | |
|--|-------------------|---|----|---|------|---|
|  Electrified Twin-Bin Power Track | INETPTWB-8 | — | 8" | — | \$88 | — |
|--|-------------------|---|----|---|------|---|

| Part number | Black/ base price | White | Gray | |
|--|----------------------|-------|-------|-------|
|  Receptacle for use in Electrified Twin-Bin | IN3D1-UD-8 | \$27 | +\$11 | +\$11 |
| | IN3D2-UD-8 | \$27 | +\$11 | +\$11 |
| | IN3D3-UD-8 | \$27 | +\$11 | +\$11 |
| | IN3D3U-UD-8 | \$27 | +\$11 | +\$11 |
| | IN3D4-UD-8 | \$27 | +\$11 | +\$11 |

Planna Storage exterior cabinet heights are nominal, interior case height is 21". Lateral and pedestal options are available. Units include mounting rails (see Inscape System Application Guide) that are pre-installed by the factory to accommodate the Planna Storage lateral top which is specified separately (see Accessories section). These mounting rails are ready to accept application of this lateral top on site. Bench support bracket must also be specified separately. Lateral cabinets are priced inclusive of one pair of hang file bars in each 10.5" and 12" pull out openings.

ANSI/BIFMA

With the addition of counterweights where appropriate, cabinets meet all BIFMA specifications.

COUNTERWEIGHTS

Counterweights are required for ALL freestanding units that are not anchored or ganged to other cabinets or bolted to walls/floor. Counterweights come standard with ALL mobile pedestals and must be field installed.

GLIDES

Planna units are standard with flat glides. Glides allow for 3/8" height adjustability.

LOCKS

Cabinets come standard with lock. 9900 series cabinets can be ordered non-locking. Bookcase cabinets come standard without locks. Standard with single bitted lock. If lock is not required add suffix 'N/L' after product number and deduct \$57 list per lock. For applications requiring higher security a double bitted solution is available. Random keying is standard, and keyed alike may be ordered. Master keys are available; refer to the accessories section to specify.

Cabinets originally ordered as non-locking may be field installed with the addition of locking bars and a lock core. Contact your client services representative for required parts.

Locks feature removable core and are standard with two keys, one of which has a black neoprene plastic key cover. Locks may be ordered for field installation. Specify cabinet height and width or model number.

NOTE: Locks cannot be field installed on hinged door cabinets.



9900 Series Note: Pedestals with 9900 series fronts must be specified beneath 1" Nuform worksurfaces only.

FINISHES

All units are finished in standard 36.5° gloss baked enamel, electrostatically applied in a 2-coat process. Refer to the surface materials section for available colors. With the exception of custom micas, whites and metallic; custom colors are available at an up-charge and are be subject to extended lead times. All interior drawers/ shelf bodies, exposed hardware (excluding European style hinges) hang file bars, dividers and media frames are finished in Eco Black.

FRONT DETAILS & PULL OPTIONS

9900 Series fronts have full width integral pulls with enamel finish to match case fronts. Refer to the images and chart below for pull application on Nuform fronts.

| Pull | Nuform |
|--|--------|
|  FP001 P290 Aluminum Leaf Finish | ● |
|  FP004 Brushed Nickel Finish | ● |
|  FP005 Brushed Nickel Finish | ○ |

● Available ○ Unavailable

Pulls FP004 and FP005 meet the guidelines for ADA compliance.





FP001 is the default pull for Nuform

- Planna Storage case comes with optional Planna Storage rail
- **DO NOT option yes for rail if mounting a cushion on the case**
- **When "no rail" is optioned there will still be mounting holes in the top of the case. Cover with cushion or common top**
- 18"D lateral case
- Height noted below includes 1/2" Planna Storage rail.
Adding a Planna common top will add an additional 1/2"
- FP001 pull is standard for Nuform fronts
- Consult General Information for pull options

NOTE

If Planna Storage rail is not required deduct the following:

- 30" W unit deduct \$157
- 36" W unit deduct \$162
- 42" W unit deduct \$168





| | | Part number | H | W | Wt (lbs) | Neutral paint/ base price | Accent paint |
|---|---|-----------------------|---------|-----|----------|------------------------------|-----------------|
|  | Bookcase with 1 shelf | PLN3021BK-SH | 24 3/8" | 30" | 59 | \$1065 | +\$108 |
| | | PLN3621BK-SH | 24 3/8" | 36" | 69 | \$1115 | +\$114 |
| | | PLN4221BK-SH | 24 3/8" | 42" | 79 | \$1183 | +\$121 |
|  | Bookcase with Electrical Cut Out | PLN3021BKCO-SH | 24 3/8" | 30" | 59 | \$1313 | +\$133 |
| | | PLN3621BKCO-SH | 24 3/8" | 36" | 69 | \$1353 | +\$138 |
| | | PLN4221BKCO-SH | 24 3/8" | 42" | 79 | \$1401 | +\$142 |
|  | Bookcase with Electrical Cut Out and Drop Down Hinge Door | PLN3021BKOPDM | 24 3/8" | 30" | 62 | \$1518 | +\$154 |
| | | PLN3621BKOPDM | 24 3/8" | 36" | 72 | \$1571 | +\$160 |
| | | PLN4221BKOPDM | 24 3/8" | 42" | 82 | \$1635 | +\$167 |
|  | Bookcase with Magazine Shelf | PLN3021-SHMS | 24 3/8" | 30" | 59 | \$1098 | +\$112 |
| | | PLN3621-SHMS | 24 3/8" | 36" | 69 | \$1145 | +\$118 |
| | | PLN4221-SHMS | 24 3/8" | 42" | 79 | \$1206 | +\$124 |
|  | 9900 Series Front 2-10.5" files | PLN30-2F10E | 24 3/8" | 30" | 80 | \$1252 | +\$128 |
| | | PLN36-2F10E | 24 3/8" | 36" | 90 | \$1304 | +\$132 |
| | | PLN42-2F10E | 24 3/8" | 42" | 116 | \$1353 | +\$138 |

- Planna Storage case comes with optional Planna Storage rail
- **DO NOT option yes for rail if mounting a cushion on the case**
- **When "no rail" is optioned there will still be mounting holes in the top of the case. Cover with cushion or common top**
- 18" D lateral case
- Height noted below includes ½" Planna Storage rail. Adding a Planna common top will add an additional ½"
- FP001 pull is standard for Nuform fronts
- Consult General Information for pull options

NOTE

If Planna Storage rail is not required deduct the following:

- 30" W unit deduct \$157
- 36" W unit deduct \$162
- 42" W unit deduct \$168



| | | Part number | H | W | Wt (lbs) | Nuform classic/ neutral paint/ base price | Nuform select | Accent paint |
|---|---|----------------------|-------|-----|----------|---|------------------|-----------------|
|  | Nuform Front 2-10.5" files | PLN30-2F10Q | 24 ¾" | 30" | 80 | \$1551 | +\$172 | +\$159 |
| | | PLN36-2F10Q | 24 ¾" | 36" | 90 | \$1617 | +\$179 | +\$165 |
| | | PLN42-2F10Q | 24 ¾" | 42" | 116 | \$1683 | +\$187 | +\$171 |
|  | 9900 Series Front 3" pencil, 6" box, 12" file | PLN30-PBFE | 24 ¾" | 30" | 80 | \$1388 | — | +\$141 |
| | | PLN36-PBFE | 24 ¾" | 36" | 90 | \$1439 | — | +\$145 |
| | | PLN42-PBFE | 24 ¾" | 42" | 116 | \$1489 | — | +\$151 |
|  | 9900 Series Front 3" pencil, 7.5" box, 10.5" file | PLN30-PB7F10E | 24 ¾" | 30" | 80 | \$1325 | — | +\$134 |
| | | PLN36-PB7F10E | 24 ¾" | 36" | 90 | \$1381 | — | +\$140 |
| | | PLN42-PB7F10E | 24 ¾" | 42" | 116 | \$1419 | — | +\$143 |
|  | 9900 Series Front 4.5" box, 6" box, 10.5" file | PLN30-B4BF10E | 24 ¾" | 30" | 80 | \$1325 | — | +\$134 |
| | | PLN36-B4BF10E | 24 ¾" | 36" | 90 | \$1381 | — | +\$140 |
| | | PLN42-B4BF10E | 24 ¾" | 42" | 116 | \$1419 | — | +\$143 |

- Planna Storage case comes with optional Planna Storage rail
- **DO NOT option yes for rail if mounting a cushion on the case**
- **When "no rail" is optioned there will still be mounting holes in the top of the case. Cover with cushion or common top**
- 18"D lateral case
- Height noted below includes ½" Planna Storage rail. Adding a Planna common top will add an additional ½"
- FP001 pull is standard for Nuform fronts
- Consult General Information for pull options

NOTE

If Planna Storage rail is not required deduct the following:

- 30" W unit deduct \$157
- 36" W unit deduct \$162
- 42" W unit deduct \$168



| | | Part number | H | W | Wt (lbs) | Neutral paint/ base price | Accent paint |
|---|--|-----------------------|-------|-----|----------|------------------------------|-----------------|
|  | 9900 Series Front 6" box, bookcase | PLN3021-BBKE | 24 ¾" | 30" | 70 | \$1397 | +\$141 |
| | | PLN3621-BBKE | 24 ¾" | 36" | 85 | \$1456 | +\$146 |
| | | PLN4221-BBKE | 24 ¾" | 42" | 100 | \$1516 | +\$154 |
|  | 9900 Series Front Bookcase, 10.5" file | PLN3021-BKF10E | 24 ¾" | 30" | 70 | \$1382 | +\$140 |
| | | PLN3621-BKF10E | 24 ¾" | 36" | 90 | \$1430 | +\$144 |
| | | PLN4221-BKF10E | 24 ¾" | 42" | 100 | \$1489 | +\$151 |
|  | 9900 Series Front 3" pencil, bookcase | PLN3021-PBKE | 24 ¾" | 30" | 70 | \$1326 | +\$134 |
| | | PLN3621-PBKE | 24 ¾" | 36" | 85 | \$1383 | +\$140 |
| | | PLN4221-PBKE | 24 ¾" | 42" | 100 | \$1441 | +\$145 |

- Planna Storage case comes with optional Planna Storage rail
- **DO NOT option yes for rail if mounting a cushion on the case**
- **When "no rail" is optioned there will still be mounting holes in the top of the case. Cover with cushion or common top**
- 18"D lateral case
- height noted below includes ½" Planna Storage rail. Adding a Planna common top will add an additional ½"
- FP001 pull is standard for acrylic, Nuform fronts
- Consult General Information for pull options

NOTE

If Planna Storage rail is not required deduct the following:

- 30" W unit deduct \$157
- 36" W unit deduct \$162
- 42" W unit deduct \$168

| | | Part number | H | W | Wt (lbs) | Nuform classic/ neutral paint/ base price | Nuform select | Accent paint |
|---|--|----------------------|-------|-----|----------|---|------------------|-----------------|
|  | 9900 Series Front Hinged Door with 1 Shelf | PLN3021HDE-SH | 24 ¾" | 30" | 57 | \$1260 | — | +\$129 |
| | | PLN3621HDE-SH | 24 ¾" | 36" | 76 | \$1273 | — | +\$130 |
| | | PLN4221HDE-SH | 24 ¾" | 42" | 95 | \$1315 | — | +\$133 |
|  | Frosted Acrylic Hinged Door with 1 Shelf | PLN3021HDJ-SH | 24 ¾" | 30" | 57 | \$2008 | — | +\$204 |
| | | PLN3621HDJ-SH | 24 ¾" | 36" | 76 | \$2132 | — | +\$215 |
| | | PLN4221HDJ-SH | 24 ¾" | 42" | 95 | \$2274 | — | +\$229 |
|  | Nuform Front Hinged Door with 1 Shelf | PLN3021HDQ-SH | 24 ¾" | 30" | 57 | \$1489 | +\$166 | +\$151 |
| | | PLN3621HDQ-SH | 24 ¾" | 36" | 76 | \$1542 | +\$171 | +\$157 |
| | | PLN4221HDQ-SH | 24 ¾" | 42" | 95 | \$1595 | +\$177 | +\$162 |

- Planna Storage case comes with optional Planna Storage rail
- **DO NOT option yes for rail if mounting a cushion on the case**
- **When “no rail” is optioned there will still be mounting holes in the top of the case. Cover with cushion or common top**
- 15" W pedestal case
- Height noted below includes ½" Planna Storage rail. Adding a Planna common top will add an additional ½"
- FP001 pull is standard for Nuform fronts
- Consult General Information for pull options

NOTE

If Planna Storage rail is not required deduct the following:



- 18" D unit deduct \$152
- 22" D unit deduct \$157
- 28" D unit deduct \$162

OPTIONAL ACCESSORIES



All pedestal accessories are optional. See chart below for information an accessories by drawer height.

| Drawer Height | Product Code | Product Description | Price |
|---|--------------|-------------------------|-------|
| 3" & 4.5" | PFWS-PTxx | Pencil Tray | \$37 |
| 6" & 7.5" | PFWS-PTxx | Pencil Tray | \$37 |
| | PFWS-DVxx | Divider | \$22 |
| 18"D, 22"D, 28"D Pedestals Only (28"D requires 2 per drawer) | | | |
| 10.5", 12", 13.5, & 15" | PFSSFxx | Side-To-Side Filing Bar | \$8 |

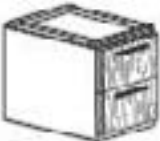



Visit the [Pedestal Accessories](#) section for full accessory details.

| | Part number | H | W | Wt (lbs) | Nuform classic/ neutral paint/ base price | Nuform select | Accent paint |
|--|------------------------|-------|-----|----------|---|------------------|-----------------|
|  <p>9900 Series Front 2-10.5" files</p> | PLN1518E-2F10.5 | 24 ¾" | 18" | 75 | \$966 | — | +\$99 |
| | PLN1522E-2F10.5 | 24 ¾" | 22" | 85 | \$1036 | — | +\$105 |
| | PLN1528E-2F10.5 | 24 ¾" | 28" | 95 | \$1072 | — | +\$108 |
|  <p>9900 Series Front 3" pencil, 6" box, 12" file</p> | PLN1518E-PBF | 24 ¾" | 18" | 75 | \$1018 | — | +\$104 |
| | PLN1522E-PBF | 24 ¾" | 22" | 85 | \$1123 | — | +\$115 |
| | PLN1528E-PBF | 24 ¾" | 28" | 95 | \$1173 | — | +\$120 |
|  <p>Nuform Front 2-10.5" file</p> | PLN1518Q-2F10.5 | 24 ¾" | 18" | 75 | \$1291 | +\$143 | +\$131 |
| | PLN1522Q-2F10.5 | 24 ¾" | 22" | 85 | \$1355 | +\$151 | +\$138 |
| | PLN1528Q-2F10.5 | 24 ¾" | 28" | 95 | \$1531 | +\$170 | +\$156 |

- Install on case where adjacent case is same width, allows for sliding door to cover both cases
- Sliding doors are handed and should be ordered based on direction of slide to open door
- Pull includes a 2" silver pull detail in upper quadrant of doors edge
- Sliding door must be mounted on two up-mount bins of equal size that are side by side

| | | Part number | H | W | Wt (lbs) | Neutral paint/ base price | Nuform select | Accent paint | |
|---|-----------------------------|----------------------------|--------------------|---------|----------|------------------------------|------------------|-----------------|-------|
|  | Nuform Classic Sliding Door | SWBL3021SDS | 25 3/4" | 30" | 8 | \$645 | — | +\$66 | |
| | | SWBL3621SDS | 25 3/4" | 36" | 10 | \$694 | — | +\$71 | |
| | | SWBL4221SDS | 25 3/4" | 42" | 11 | \$736 | — | +\$76 | |
| | | | left-handed | | | | | | |
| | | | SWBR3021SDS | 25 3/4" | 30" | 8 | \$645 | — | +\$66 |
| | | | SWBR3621SDS | 25 3/4" | 36" | 10 | \$694 | — | +\$71 |
| | | SWBR4221SDS | 25 3/4" | 42" | 11 | \$736 | — | +\$76 | |
| | | right-handed (illustrated) | | | | | | | |
|  | Nuform Select Sliding Door | SWBL3021SDQ | 25 3/4" | 30" | 8 | \$645 | +\$72 | +\$66 | |
| | | SWBL3621SDQ | 25 3/4" | 36" | 10 | \$694 | +\$78 | +\$71 | |
| | | SWBL4221SDQ | 25 3/4" | 42" | 11 | \$736 | +\$83 | +\$76 | |
| | | | left-handed | | | | | | |
| | | | SWBR3021SDQ | 25 3/4" | 30" | 8 | \$645 | +\$72 | +\$66 |
| | | | SWBR3621SDQ | 25 3/4" | 36" | 10 | \$694 | +\$78 | +\$71 |
| | | SWBR4221SDQ | 25 3/4" | 42" | 11 | \$736 | +\$83 | +\$76 | |
| | | right-handed (illustrated) | | | | | | | |

- Includes mounting hardware to attach to the adjacent Planna Storage cases
- 3.5" thick version only
- Specific for worksurface or cushion above
- Specific whether a cutout is required to allow electrical feed and data cabling to enter frame behind

| | | Part number | H | W | Wt (lbs) | Neutral paint/ base price | Accent paint |
|---|---|----------------------|-------|------|----------|------------------------------|-----------------|
|  | End Trim with Electrical Cutout, Worksurface compatible (worksurface above) | PLNCETCO | 25" | 3.5" | 2 | \$91 | +\$12 |
|  | End Trim without Cutout / Private Office Case Back Filler, Worksurface compatible (worksurface above) | PLNCET | 25" | 3.5" | 2 | \$88 | +\$12 |
|  | End Trim with Electrical Cutout, Cushion compatible (cushion above) | PLNCETCUSH | 25" | 3.5" | 2 | \$73 | +\$11 |
|  | End Trim without Cutout / Private Office Case Back Filler, Cushion compatible (cushion above) | PLNCETCUSH | 25" | 3.5" | 2 | \$69 | +\$10 |
|  | 6.75" H Painted Multi Access Tile for use with Planna Storage | INPL6.75MAP30 | 6.75" | 30" | 4 | \$104 | +\$13 |
| | | INPL6.75MAP36 | 6.75" | 36" | 5 | \$107 | +\$15 |
| | | INPL6.75MAP42 | 6.75" | 42" | 6 | \$115 | +\$15 |

Laminate Storage exterior cabinet heights are nominal and have an actual dimension of 23.858" from bottom of glide to top of case when the glide is at minimum position. The mobile pedestal is an exception to this dimension rule as it is 21.25". Lateral, pedestal, open bookcase, tower and overhead bin options are available.

ANSI/BIFMA

With the addition of counterweights where appropriate, cabinets meet all BIFMA specifications.

COUNTERWEIGHTS

Counterweights are required for ALL freestanding units that are not anchored or ganged to other cabinets or bolted to walls/floor. Mobile Pedestals have a fifth caster installed on front underside which works as anti-tip mechanism, eliminating requirement for counterweight

GLIDES

Laminate units are standard with flat glides. Glides allow for 1 ¼" height adjustability.

LOCKS

Lateral, pedestal, bookcase with drawers, hinged door overhead bin and tower cabinets come standard with lock. Open bookcase and open bin cabinets come standard without locks. Standard with single bitted lock in a Satin Chrome finish. For applications requiring higher security a double bitted solution is available. Random keying is standard, and keyed alike may be ordered. Master keys are available; refer to the accessories section to specify.

Locks feature removable core and are standard with two keys, one of which has a black neoprene plastic key cover. Specify cabinet height and width or model number.

OVERHEAD BRACKETS

Overheads are wall mounted and brackets are included in the code. Wall mounting brackets do not include fasteners as they are dependent on the requirements of the wall type. The installer must ensure the surface is adequately constructed and/or braced and that adequate fasteners are used to ensure a secure installation.

FINISHES

All storage cases are available in all of inscape's standard low pressure laminate options (MCC codes).

All fixed storage fronts are default as low pressure laminate (like the cases), and are mounted flush with the front of the top. Mobile pedestal fronts extend past the case top before sloping flush with the top of the case. High pressure laminate is available for storage fronts for an upcharge.

Standard edge banding is 2.5mm and compliments worksurface.

Refer to the Finishes Section of this price list for available colors.

CUSHION MOBILE PEDESTALS

The Classic Cushion is 1 ¼" thick CAL 117 compliant polyurethane foam with a 2.2 lb/ft. density. This upholstered cushion is balanced with a 7/16" board and is attached to the pedestal top with heavy duty Velcro.

Select from our graded upholstery program of solid color fabrics and vinyl's or choose COM option (Customer's Own Material). To determine if a COM fabric has been pre-approved for use on our cushion topper, contact your client services representative or log into INSITE. For application of ALL fabrics, both from our graded program as well as COM (Customer Own Material) please specify layout orientation at time of order. If layout instructions are not provided Inscape will choose the direction to maximize production. Refer to the diagram for layout options.

After calculating the total amount of material needed in inches, divide the total number of inches by 36 for the total yardage and round up to the next full yard. Allow additional for repeat. Add 15% of total fabric required for small and medium pattern repeats. Add 20% of total fabric required for large patterns.

Due to the nature of the design and manufacture of our cushion, only approved fabrics will be accepted for application. For a description of the procedure required for COM fabric approval see sample 'Cushion COM Test Request' form found in the General Information section of this price list. This form can be downloaded from the Administration section of Insite or by contacting your client services representative for assistance.

Please see Finishes section for COM calculator.

FABRIC LAY UP OF PEDESTAL CUSHIONS

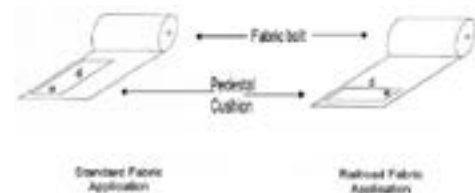

FRONT DETAILS & PULL OPTIONS

Laminate Storage offers flush fronts with surface mounted pulls. Refer to the images and chart below for pull application on Laminate Storage.

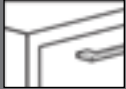
| Pull | Laminate |
|---|----------|
|  FP001 P290 Aluminum Leaf Finish | ● |
|  FP004 Brushed Nickel Finish | ● |

- Available
- Unavailable

Pull FP004 meet the guidelines for ADA compliance.

FP001 pull is the default pull for all Laminate Storage.

- Mobile and fixed pedestal options available
- Both laminate pedestal options are locking
- Available pull options for Laminate Storage are FP001 and FP004 (default)
- Storage cases are available in any of Inscape's standard low pressure laminate options (MCC codes)
- Storage fronts are standard in any of Inscape's standard low pressure laminate options (MCC codes) but have the option to select a corresponding high pressure laminate for an upcharge
- Mobile Laminate Pedestals have an optional Classic cushion which is inset from the drawer fronts
- Fixed Laminate Pedestals must be used in a Hat Channel or a Rail Kit with common top application in order to support a worksurface at a 28.5" height
- Mobile pedestal has a caster at each corner and a single caster in the middle of the underside of the unit to make a total of 5 casters. The 5th caster acts as a counterweight.
- Laminate Storage exterior cabinet heights are nominal and have an actual dimension of 23.858" from bottom of glide to top of the case when the glide is at minimum position. The mobile pedestal is an exception to this dimension rule as it is 21.25" H.

- For application of ALL fabrics, both from our graded program as well as COM (customers own material), please specify layup orientation at time of order. If layup instructions are not provided we will choose the direction to maximize our production. Refer to the Finishes Section for additional layout and COM details.
- Models ordered with counter weights will be installed by default to the bottom shelf. When the counter weight is ordered separately it can field installed either on the bottom or the back of the unit.

NOTES

In order to get a total cost on products when upcharges are present take the list price of the product number and add the upcharge cost shown to the list price.

For example:

Product LL1518-BFMC in Grade B/COM fabric would be \$1101 +\$57LL1518-BFMC in Grade C fabric would be \$1101 +\$103

| | Part number | Exterior Height | W | D | Wt (lbs) | Grade A/ base price | High pressure laminate front option | No cushion option |
|---|--------------------|-----------------|---------|-----|----------|------------------------|-------------------------------------|-------------------|
|  <p>6" box, 12" file Laminate Mobile Pedestal Includes cushion</p> | LL1518-BFMC | 22" | 15 1/2" | 18" | — | \$1101 | +\$299 | -\$227 |
| | LL1522-BFMC | 22" | 15 1/2" | 22" | — | \$1119 | +\$309 | -\$240 |

FABRIC UPCHARGE FOR MOBILE PEDESTALS OPTIONED WITH CUSHION - CLASSIC CUSHION OPTION ONLY

Note: To price fabric grade options, add the upcharge (+\$) in the chart below to the base price of the List price (Grade A) column. This will be the total cost for that product.

| Grade B/COM | Grade C | Grade D | Grade E | Grade F |
|-------------|---------|---------|---------|---------|
| +\$57 | +\$103 | +\$145 | +\$174 | +\$249 |

| | Part number | Exterior Height | W | D | Wt (lbs) | Base price | High pressure laminate front option |
|---|--------------------|-----------------|---------|-----|----------|------------|-------------------------------------|
|  <p>8" box, 12" file Laminate Pedestal no counterweight included</p> | LL1518-BF | 24 3/8" | 15 1/2" | 18" | — | \$798 | +\$247 |
| | LL1522-BF | 24 3/8" | 15 1/2" | 22" | — | \$837 | +\$265 |
| | LL1528-BF | 24 3/8" | 15 1/2" | 28" | — | \$884 | +\$283 |
| <p>8" box, 12" file Laminate Pedestal counterweight included</p> | LL1518-BFCW | 24 3/8" | 15 1/2" | 18" | — | \$972 | +\$247 |
| | LL1522-BFCW | 24 3/8" | 15 1/2" | 22" | — | \$1009 | +\$265 |
| | LL1528-BFCW | 24 3/8" | 15 1/2" | 28" | — | \$1051 | +\$283 |

- Laterals are 18" deep and locking
- Available pull options for Laminate Storage are FP001 and FP004 (default)
- Storage cases are available in any of Inscape's standard low pressure laminate options (MCC codes)
- Storage fronts are standard in any of Inscape's standard low pressure laminate options (MCC codes) but have the option to select a corresponding high pressure laminate for an upcharge
- Mobile Laminate Laterals have an optional Classic cushion which is inset from the drawer fronts
- Mobile lateral has a caster at each corner and a single caster in the middle of the underside of the unit to make a total of 5 casters. The 5th caster acts as a counterweight.
- Laminate laterals must be used with a Hat Channel or a Rail Kit in order to support a worksurface at a 28.5" height
- Laminate Storage exterior cabinet heights are nominal and have an actual dimension of 23.858" from bottom of glide to top of bin when the glide is at minimum position

- File drawers are set up to accommodate both side to side or front to back filing Models ordered with counter weights will be installed by default to the bottom shelf. When the counter weight is ordered separately it can field installed either on the bottom or the back of the unit.

NOTES

In order to get a total cost on products when upcharges are present take the list price of the product number and add the upcharge cost shown to the list price.

For example:

Product LL24-BF with high pressure laminate fronts would be \$955 +\$242

| | Part number | Exterior Height | W | D | Wt (lbs) | Base price | High pressure laminate front option |
|---|--------------------|-----------------|-----|-----|----------|------------|-------------------------------------|
|  <p>6" box, 12" file Laminate Mobile Lateral Includes cushion</p> | LL2422-BFMC | 22" | 24" | 18" | — | \$1612 | +\$260 |
| | LL3022-BFMC | 22" | 30" | 18" | — | \$1690 | +\$283 |

FABRIC UPCHARGE FOR MOBILE LATERALS OPTIONED WITH CUSHION - CLASSIC CUSHION OPTION ONLY

Note: To price fabric grade options, add the upcharge (+\$) in the chart below to the base price of the List price (Grade A) column. This will be the total cost for that product.

| Grade B/COM | Grade C | Grade D | Grade E | Grade F |
|-------------|---------|---------|---------|---------|
| +\$83 | +\$148 | +\$178 | +\$216 | +\$314 |

| | Part number | Exterior Height | W | D | Wt (lbs) | Base price | High pressure laminate front option |
|--|------------------|-----------------|-----|-----|----------|------------|-------------------------------------|
|  <p>8" box, 12" file Laminate Lateral no counterweight included</p> | LL24-BF | 24 3/8" | 24" | 18" | — | \$955 | +\$242 |
| | LL30-BF | 24 3/8" | 30" | 18" | — | \$1044 | +\$260 |
| | LL36-BF | 24 3/8" | 36" | 18" | — | \$1087 | +\$283 |
| | LL42-BF | 24 3/8" | 42" | 18" | — | \$1136 | +\$303 |
| <p>8" box, 12" file Laminate Lateral no counterweight included</p> | LL24-BFCW | 24 3/8" | 24" | 18" | — | \$1132 | +\$242 |
| | LL30-BFCW | 24 3/8" | 30" | 18" | — | \$1227 | +\$260 |
| | LL36-BFCW | 24 3/8" | 36" | 18" | — | \$1257 | +\$283 |
| | LL42-BFCW | 24 3/8" | 42" | 18" | — | \$1302 | +\$303 |

- Bookcases are 18" deep
- Available pull options for Laminate Storage are FP001 and FP004 (default)
- Storage cases are available in any of Inscape's standard low pressure laminate options (MCC codes)
- Storage fronts are standard in any of Inscape's standard low pressure laminate options (MCC codes) but have the option to select a corresponding high pressure laminate for an upcharge
- Laminate Bookcases must be used with a Hat Channel or a Rail Kit in order to support a work surface at a 28.5" height
- Laminate Storage exterior cabinet heights are nominal and have an actual dimension of 23.858" from bottom of glide to top of bin when the glide is at minimum position





- Laminate Open Bookcase with electrical height adjustable cut out is to be used with freestanding tables. The cut out in the top surface will be raw and sealed with a clear varnish.

NOTES

In order to get a total cost on products when upcharges are present take the list price of the product number and add the upcharge cost shown to the list price.

For example:

Product LL2421BKCOPDM with high pressure laminate fronts would be \$1491 +\$227

| | | Part number | Exterior Height | W | D | Wt (lbs) | Base price | High pressure laminate front option | |
|---|--|---------------------------|-----------------|-----|-----|----------|------------|-------------------------------------|--|
|  | Laminate Open Bookcase with 1 adjustable shelf | LL2421BK-SH | 24 3/8" | 24" | 18" | — | \$798 | — | |
| | | LL3021BK-SH | 24 3/8" | 30" | 18" | — | \$866 | — | |
| | | LL3621BK-SH | 24 3/8" | 36" | 18" | — | \$907 | — | |
| | | LL4221BK-SH | 24 3/8" | 42" | 18" | — | \$969 | — | |
|  | Laminate Open Bookcase with 1 shelf and electrical cut out | LL2421BKCO-SH | 24 3/8" | 24" | 18" | — | \$907 | — | |
| | | LL3021BKCO-SH | 24 3/8" | 30" | 18" | — | \$981 | — | |
| | | LL3621BKCO-SH | 24 3/8" | 36" | 18" | — | \$1050 | — | |
| | | LL4221BKCO-SH | 24 3/8" | 42" | 18" | — | \$1090 | — | |
|  | Laminate Open Bookcase with 1 shelf and electrical cut out with drop down door | LL2421BKCOPDM | 24 3/8" | 24" | 18" | — | \$1491 | +\$227 | |
| | | LL3021BKCOPDM | 24 3/8" | 30" | 18" | — | \$1548 | +\$237 | |
| | | LL3621BKCOPDM | 24 3/8" | 36" | 18" | — | \$1640 | +\$242 | |
| | | LL4221BKCOPDM | 24 3/8" | 42" | 18" | — | \$1709 | +\$255 | |
|  | Laminate Open Bookcase with electrical height adjustable cut out | LL2421BKHACOL | 24 3/8" | 24" | 18" | — | \$967 | — | |
| | | LL3021BKHACOL | 24 3/8" | 30" | 18" | — | \$1043 | — | |
| | | left-handed (illustrated) | | | | | | | |
| | | LL2421BKHACOR | 24 3/8" | 24" | 18" | — | \$967 | — | |
| | | LL3021BKHACOR | 24 3/8" | 30" | 18" | — | \$1043 | — | |
| | | right-handed | | | | | | | |

- Combination Bookcase/Laterals are 18" deep and locking
- Available pull options for Laminate Storage are FP001 and FP004 (default)
- Storage cases are available in any of Inscape's standard low pressure laminate options (MCC codes)
- Storage fronts are standard in any of Inscape's standard low pressure laminate options (MCC codes) but have the option to select a corresponding high pressure laminate for an upcharge
- Laminate Combination Bookcase/Laterals must be used with a Hat Channel or a Rail Kit in order to support a worksurface at a 28.5" height
- Laminate Storage exterior cabinet heights are nominal and have an actual dimension of 23.858" from bottom of glide to top of bin when the glide is at minimum position
- File drawers are set up to accommodate both side to side or front to back filing



- Models ordered with counter weights will be installed by default to the bottom shelf. When the counter weight is ordered separately it can field installed either on the bottom or the back of the unit.

NOTES

In order to get a total cost on products when upcharges are present take the list price of the product number and add the upcharge cost shown to the list price.

For example:

Product LL2421-BKF with high pressure laminate fronts would be \$1125 +\$270

| | Part number | Exterior Height | W | D | Wt (lbs) | Base price | High pressure laminate front option |
|---|---------------------|-----------------|-----|-----|----------|------------|-------------------------------------|
|  <p>Laminate Open Bookcase with 12" file drawer below no counterweight included</p> | LL2421-BKF | 24 3/8" | 24" | 18" | — | \$1125 | +\$270 |
| | LL3021-BKF | 24 3/8" | 30" | 18" | — | \$1166 | +\$289 |
| | LL3621-BKF | 24 3/8" | 36" | 18" | — | \$1208 | +\$308 |
| | LL4221-BKF | 24 3/8" | 42" | 18" | — | \$1295 | +\$326 |
| <p>Laminate Open Bookcase with 12" file drawer below counterweight included</p> | LL2421-BKFCW | 24 3/8" | 24" | 18" | — | \$1304 | +\$270 |
| | LL3021-BKFCW | 24 3/8" | 30" | 18" | — | \$1350 | +\$289 |
| | LL3621-BKFCW | 24 3/8" | 36" | 18" | — | \$1375 | +\$308 |
| | LL4221-BKFCW | 24 3/8" | 42" | 18" | — | \$1474 | +\$326 |
|  <p>Laminate Open Bookcase with 8" box drawer above no counterweight included</p> | LL2421-BBK | 24 3/8" | 24" | 18" | — | \$1136 | +\$167 |
| | LL3021-BBK | 24 3/8" | 30" | 18" | — | \$1181 | +\$171 |
| | LL3621-BBK | 24 3/8" | 36" | 18" | — | \$1233 | +\$189 |
| | LL4221-BBK | 24 3/8" | 42" | 18" | — | \$1295 | +\$200 |
| <p>Laminate Open Bookcase with 8" box drawer above counterweight included</p> | LL2421-BBKCW | 24 3/8" | 24" | 18" | — | \$1325 | +\$167 |
| | LL3021-BBKCW | 24 3/8" | 30" | 18" | — | \$1352 | +\$171 |
| | LL3621-BBKCW | 24 3/8" | 36" | 18" | — | \$1413 | +\$189 |
| | LL4221-BBKCW | 24 3/8" | 42" | 18" | — | \$1473 | +\$200 |

- Hinged Door Cabinets are 18" deep and locking
- Available pull options for Laminate Storage are FP001 and FP004 (default)
- Storage cases are available in any of Inscape's standard low pressure laminate options (MCC codes)
- Storage fronts are standard in any of Inscape's standard low pressure laminate options (MCC codes) but have the option to select a corresponding high pressure laminate for an upcharge
- Laminate Hinged Door Cabinets must be used with a Hat Channel or a Rail Kit in order to support a worksurface at a 28.5" height
- Laminate Storage exterior cabinet heights are nominal and have an actual dimension of 23.858" from bottom of glide to top of bin when the glide is at minimum position

NOTES

In order to get a total cost on products when upcharges are present take the list price of the product number and add the upcharge cost shown to the list price.

For example:

Product LL2421HD-SH with high pressure laminate fronts would be \$1010 +\$218



Laminate Hinged Door Cabinet with 1 adjustable shelf

| Part number | Exterior Height | W | D | Wt (lbs) | Base price | High pressure laminate front option |
|--------------------|-----------------|-----|-----|----------|------------|-------------------------------------|
| LL2421HD-SH | 24 3/8" | 24" | 18" | — | \$1010 | +\$218 |
| LL3021HD-SH | 24 3/8" | 30" | 18" | — | \$1051 | +\$227 |
| LL3621HD-SH | 24 3/8" | 36" | 18" | — | \$1058 | +\$242 |
| LL4221HD-SH | 24 3/8" | 42" | 18" | — | \$1092 | +\$255 |

- Available pull options for Laminate Storage are FP001 and FP004 (default)
- Hinged Door option is locking, the open and sliding door overheads are non-locking
- Storage cases are available in any of Inscape's standard low pressure laminate options (MCC codes)
- Storage fronts are standard in any of Inscape's standard low pressure laminate options (MCC codes) but have the option to select a corresponding high pressure laminate for an upcharge
- Wall mount brackets included but fasteners are not as they are dependent on the requirements of the wall type
- Open Overhead Bins that are 36" w or larger will have a center divider that creates two openings
- Hinged Door Overhead Bins that are 36" w or larger will have a center divider and the unit will have four doors
- Ensure the wall is adequately constructed and/or braced and that adequate fasteners are used to ensure a secure installation.





- Shelf maximum weight capacity is 50lbs.
- Wall mounted brackets are included when specifying each overhead shelf
- Shelf is available in high pressure laminate and mounting brackets are painted
- Wall mounting brackets do not include fasteners as they are dependent on the requirements of the wall type

NOTES

In order to get a total cost on products when upcharges are present take the list price of the product number and add the upcharge cost shown to the list price.

For example:

Product LLSDBIN-24 with high pressure laminate fronts would be \$872 +\$222

| | | Part number | Exterior Height | W | D | Wt (lbs) | Base price | High pressure laminate front option |
|---|---|-------------|-----------------|-----|---------|----------|------------|-------------------------------------|
|  | Laminate Overhead Open Bin | LLOBIN-24 | 14" | 24" | 15" | — | \$731 | — |
| | | LLOBIN-30 | 14" | 30" | 15" | — | \$795 | — |
| | | LLOBIN-36 | 14" | 36" | 15" | — | \$861 | — |
| | | LLOBIN-42 | 14" | 42" | 15" | — | \$927 | — |
| | | LLOBIN-48 | 14" | 48" | 15" | — | \$992 | — |
| | | LLOBIN-54 | 14" | 54" | 15" | — | \$1059 | — |
| | | LLOBIN-60 | 14" | 60" | 15" | — | \$1125 | — |
|  | Laminate Overhead Bin with one sliding door | LLSDBIN-24 | 14" | 24" | 15" | — | \$872 | +\$222 |
| | | LLSDBIN-30 | 14" | 30" | 15" | — | \$947 | +\$242 |
| | | LLSDBIN-36 | 14" | 36" | 15" | — | \$1021 | +\$255 |
| | | LLSDBIN-42 | 14" | 42" | 15" | — | \$1096 | +\$275 |
| | | LLSDBIN-48 | 14" | 48" | 15" | — | \$1170 | +\$289 |
| | | LLSDBIN-54 | 14" | 54" | 15" | — | \$1245 | +\$308 |
| | | LLSDBIN-60 | 14" | 60" | 15" | — | \$1319 | +\$321 |
|  | Laminate Overhead Bin with hinged doors | LLHDBIN-24 | 14" | 24" | 15 3/4" | — | \$991 | +\$209 |
| | | LLHDBIN-30 | 14" | 30" | 15 3/4" | — | \$1046 | +\$227 |
| | | LLHDBIN-36 | 14" | 36" | 15 3/4" | — | \$1099 | +\$242 |
| | | LLHDBIN-42 | 14" | 42" | 15 3/4" | — | \$1153 | +\$260 |
| | | LLHDBIN-48 | 14" | 48" | 15 3/4" | — | \$1206 | +\$275 |
| | | LLHDBIN-54 | 14" | 54" | 15 3/4" | — | \$1259 | +\$293 |
| | | LLHDBIN-60 | 14" | 60" | 15 3/4" | — | \$1314 | +\$308 |
|  | Laminate Overhead Open Shelf | LLOOS-24 | 6" | 24" | 12" | — | \$432 | |
| | | LLOOS-30 | 6" | 30" | 12" | — | \$486 | |
| | | LLOOS-36 | 6" | 36" | 12" | — | \$540 | |
| | | LLOOS-42 | 6" | 42" | 12" | — | \$621 | |
| | | LLOOS-48 | 6" | 48" | 12" | — | \$702 | |



- Available pull options for Laminate Storage are FP001 and FP004 (default)
- FP001 pull is not recommended for Manhattan Towers
- Storage cases are available in any of Inscape's standard low pressure laminate options (MCC codes)
- Storage fronts are standard in any of Inscape's standard low pressure laminate options (MCC codes) but have the option to select a corresponding high pressure laminate for an upcharge
- The Tower with 12" drawers offer front to back letter sized filing and do not have face mounted pulls.
- Interior accessory and shelf options differ slightly between height options for both tower types
- File drawers are set up to accommodate both side to side or front to back filing
- All Towers below include a coat hook

NOTES

In order to get a total cost on products when upcharges are present take the list price of the product number and add the upcharge cost shown to the list price.

For example:

Product LLMA2236-L with high pressure laminate fronts would be \$3098 +\$308

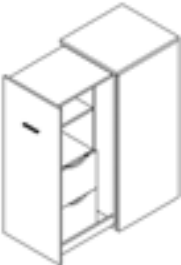
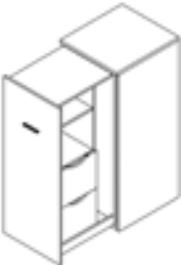
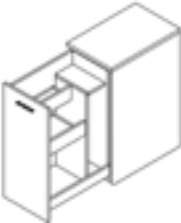
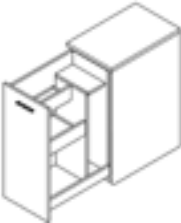
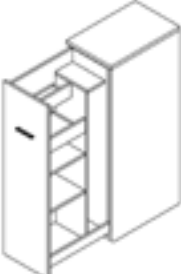
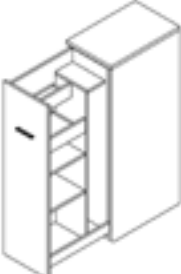

| | | Part number | Exterior Height | W | D | Wt (lbs) | Base price | High pressure laminate front option |
|---|---|---------------------------|-----------------|---------|-----|----------|------------|-------------------------------------|
|  | 36"H Tower with 6" wardrobe on one side, 2-12" drawers with opening above on the other | LLMA2236-L | 36" | 22" | 24" | — | \$3098 | +\$308 |
| | | left handed (illustrated) | | | | | | |
|  | | LLMA2236-R | 36" | 22" | 24" | — | \$3098 | +\$308 |
| | | right handed | | | | | | |
|  | 54"H Tower with 6" wardrobe and 1 adjustable shelf on one side, 2-12" drawers with opening above and adjustable shelf on the other | LLMA2254-L | 54" | 22" | 24" | — | \$3384 | +\$308 |
| | | left handed (illustrated) | | | | | | |
|  | | LLMA2254-R | 54" | 22" | 24" | — | \$3384 | +\$308 |
| | | right handed | | | | | | |
|  | 36"H Slide Out Tower with wardrobe and multiple storage compartments Shelves are fixed height | LLMB1536-L | 36" | 15 1/2" | 24" | — | \$2815 | +\$308 |
| | | left handed (illustrated) | | | | | | |
|  | | LLMB1536-R | 36" | 15 1/2" | 24" | — | \$2815 | +\$308 |
| | | right handed | | | | | | |
|  | 54"H Slide Out Tower with wardrobe and multiple storage compartments Bottom two shelves are adjustable, top two are fixed height | LLMB1554-L | 54" | 15 1/2" | 24" | — | \$3102 | +\$308 |
| | | left handed (illustrated) | | | | | | |
|  | | LLMB1554-R | 54" | 15 1/2" | 24" | — | \$3102 | +\$308 |
| | | right handed | | | | | | |

Storage





Laminate Storage
Accessories Trim and Connectors

System

- End Filler Trim Includes mounting hardware to attach to the adjacent Laminate Storage cases
- End Filler Trim is available in any of Inscape's standard low pressure laminate options (MCC codes)
- Specific for cushion, common top or rail kit with common top above

| | | Part number | H | W | D | Wt (lbs) | List price |
|---|--|---------------|-----|------|---|----------|------------|
|  | Ganging Kit for Laminate Storage | PFGK-L | — | — | — | — | \$15 |
|  | End Filler Trim without Cutout To be used in a cushion, common top or rail kit with top application | LLETNC | 25" | 3 ½" | — | — | \$133 |
|  | End Filler Trim with Cutout To be used in a cushion, common top or rail kit with top application | LLETCO | 25" | 3 ½" | — | — | \$158 |

- Hat Channel heights are nominal and they support a standard worksurface height of 28.5"
- Hat Channels are available in any of Inscape's standard paint finishes
- Rail kits are optional on laminate cases, DO NOT specify if a cushion is to be installed
- Lateral kits install with the rail running the width of the case (side to side)
- Pedestal kits install with the rail running the depth of the case (front to back)
- Planna Storage Support Brackets are shipped as a pair and are both required worksurface installation

| | | Part number | H | W | D | Wt (lbs) | Neutral paint/ base price | Accent paint |
|---|---|---------------------|--------|---------|-----|----------|------------------------------|-----------------|
|  | 9"W x 3.363"H Hat Channel For use with Laminate Storage with no common top or rail kit | HATCHNL3.363 | 3 1/3" | 9" | 3" | 2 | \$52 | +\$9 |
|  | Lateral Rail Kit with wood screws | LL-KIT24 | — | 24" | 18" | 5 | \$157 | +\$18 |
| | | LL-KIT30 | — | 30" | 18" | 5 | \$161 | +\$18 |
| | | LL-KIT36 | — | 36" | 18" | 6 | \$166 | +\$18 |
| | | LL-KIT42 | — | 42" | 18" | 6 | \$171 | +\$19 |
|  | Pedestal Rail Kit with wood screws | LL-KIT15.518 | — | 15 1/2" | 18" | 3 | \$156 | +\$17 |
| | | LL-KIT15.522 | — | 15 1/2" | 22" | 4 | \$161 | +\$18 |
| | | LL-KIT15.528 | — | 15 1/2" | 28" | 5 | \$166 | +\$18 |
|  | Planna Bracket (pair) Adjustable Height | PSUPBKT | — | — | — | 1 | \$92 | +\$12 |

- Classic Cushions
- These cushions are specified and shipped separately from the case
- Velcro is included with the cushion for adhesion on the case
- Cushions are 1.25" thick and are to be specified with using only approved Upholstery standards from Inscape or COM
- For application of ALL fabrics, both from our graded program as well as COM (customers own material), please specify layup orientation at time of order. If layup instructions are not provided we will choose the direction to maximize our production. Refer to the Finishes Section for additional layout and COM details.

NOTES

In order to get a total cost on products when upcharges are present take the list price of the product number and add the upcharge cost shown to the list price.

For example:



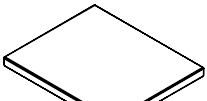

Product LLPEDCUSH1518SL in Grade C fabric would be \$275 +\$103

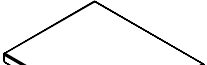
| | Part number | H | W | D | Wt (lbs) | Grade A/ base price | Grade B/ COM | Grade C | Grade D | Grade E | Grade F |
|---|------------------------|------|-------|-----|----------|------------------------|-----------------|---------|---------|---------|---------|
|  | LLPEDCUSH1518SL | 1 ¼" | 15 ½" | 18" | — | \$275 | +\$57 | +\$103 | +\$145 | +\$174 | +\$249 |
| | LLPEDCUSH1522SL | 1 ¼" | 15 ½" | 22" | — | \$281 | +\$57 | +\$103 | +\$145 | +\$174 | +\$249 |
| | LLPEDCUSH1528SL | 1 ¼" | 15 ½" | 28" | — | \$291 | +\$57 | +\$103 | +\$145 | +\$174 | +\$249 |

Cushion for
Laminate Pedestal

| | | | | | | | | | | | |
|--|-----------------------|------|-------|-------|---|-------|-------|--------|--------|--------|--------|
|  | LLPEDMCUSH1518 | 1 ¼" | 15 ½" | 17.2" | — | \$275 | +\$57 | +\$103 | +\$145 | +\$174 | +\$249 |
| | LLPEDMCUSH1522 | 1 ¼" | 15 ½" | 21.2" | — | \$281 | +\$57 | +\$103 | +\$145 | +\$174 | +\$249 |

Cushion for
Laminate Mobile
Pedestal

| | Part number | W | D | Thickness | Laminate/ base price | Grade 1 laminate |
|---|------------------|---------|------|-----------|-------------------------|------------------|
|  Pedestal Top | LLN1518 | 15" | 18" | 1/2" | \$90 | +\$30 |
| | LLN1522 | 15" | 22" | 1/2" | \$118 | +\$39 |
| | LLN1528 | 15" | 28" | 1/2" | \$144 | +\$48 |
|  Pedestal Top | LLN15.518 | 15 1/2" | 18" | 1/2" | \$90 | +\$30 |
| | LLN15.222 | 15 1/2" | 22" | 1/2" | \$118 | +\$39 |
| | LLN15.528 | 15 1/2" | 28" | 1/2" | \$144 | +\$48 |
|  18"D Single Depth Lateral Top | LLN1830 | 30" | 18" | 1/2" | \$156 | +\$51 |
| | LLN1836 | 36" | 18" | 1/2" | \$179 | +\$59 |
| | LLN1842 | 42" | 18" | 1/2" | \$204 | +\$66 |
| | LLN1845 | 45" | 18" | 1/2" | \$221 | +\$72 |
| | LLN1845.5 | 45 1/2" | 18" | 1/2" | \$221 | +\$72 |
| | LLN1851 | 51" | 18" | 1/2" | \$237 | +\$77 |
| | LLN1851.5 | 51 1/2" | 18" | 1/2" | \$237 | +\$77 |
| | LLN1857 | 57" | 18" | 1/2" | \$256 | +\$85 |
| | LLN1857.5 | 57 1/2" | 18" | 1/2" | \$256 | +\$85 |
| | LLN1860 | 60" | 18" | 1/2" | \$273 | +\$89 |
| | LLN1866 | 66" | 18" | 1/2" | \$296 | +\$97 |
| | LLN1872 | 72" | 18" | 1/2" | \$320 | +\$103 |
| | LLN1878 | 78" | 18" | 1/2" | \$344 | +\$111 |
| | LLN1884 | 84" | 18" | 1/2" | \$366 | +\$119 |
| | LLN1890 | 90" | 18" | 1/2" | \$393 | +\$128 |
| LLN1896 | 96" | 18" | 1/2" | \$408 | +\$132 | |
|  21"D Single Depth Lateral Top | LLN2130 | 30" | 21" | 1/2" | \$173 | +\$57 |
| | LLN2136 | 36" | 21" | 1/2" | \$198 | +\$64 |
| | LLN2142 | 42" | 21" | 1/2" | \$223 | +\$73 |
| | LLN2145 | 45" | 21" | 1/2" | \$240 | +\$79 |
| | LLN2145.5 | 45 1/2" | 21" | 1/2" | \$240 | +\$79 |
| | LLN2151 | 51" | 21" | 1/2" | \$262 | +\$86 |
| | LLN2151.5 | 51 1/2" | 21" | 1/2" | \$262 | +\$86 |
| | LLN2157 | 57" | 21" | 1/2" | \$279 | +\$91 |
| | LLN2157.5 | 57 1/2" | 21" | 1/2" | \$279 | +\$91 |
| | LLN2160 | 60" | 21" | 1/2" | \$300 | +\$98 |
| | LLN2166 | 66" | 21" | 1/2" | \$327 | +\$105 |
| | LLN2172 | 72" | 21" | 1/2" | \$223 | +\$114 |
| | LLN2178 | 78" | 21" | 1/2" | \$376 | +\$123 |
| | LLN2184 | 84" | 21" | 1/2" | \$400 | +\$130 |
| | LLN2190 | 90" | 21" | 1/2" | \$429 | +\$139 |
| LLN2196 | 96" | 18" | 1/2" | \$470 | +\$152 | |

System Accessories

inscape

work for tomorrow

Inscape System accessories include panel and table-mounted organizers, whiteboards, wall-mounted tack boards, panel mounted accessory shelves, pencil drawer, signage, a picture hook and coat hook. The panel and table-mounted organizers are easy to install, move and reconfigure and provide a comprehensive solution for effectively managing paper and other office supplies.

HORIZONTAL ORGANIZERS

A variety of work tool Horizontal Organizers may be positioned at any point along the width of the paper management tiles. The three slat design allows for three different height options - customizing and providing adjustability to suit individual needs and preferences. Re-positioning the height of the trays can be easily done by lifting the trays out of the slats on the tile. Horizontal paper management accessories are available in colors shown in the Color Guide. These paper management organizers can withstand max 5lbs. The storage compartments are clear plastic.

COAT HOOKS, PICTURE HOOKS AND SIGNAGE

Coat Hooks, Picture Hooks and Signage are manufactured from steel and snap onto panel crossrails without tools. Signage is available 9" W. The sign insert channel is 1" H. Insert is customer generated and can be printed on any printer compatible paper. Printing instructions are included. A strip of clear plastic slides into the channel to protect the printed identification card.

PENCIL DRAWERS

Pencil Drawers can be installed under any Inscape System worksurface, increasing the amount of usable storage within the workstation.

TOUCH UP PAINT

Touch Up Paint is available in ½ pint cans to repair minor scratches on trim, tiles and cabinets. Paint may also be specified in aerosol cans for any of our standard paint colors with the exception of mica and textured paint finishes. Custom enamel finishes are available in liquid only.

NOTE: Restrictions may apply to shipping aerosol cans; contact your Client Services Representative.

CPU HOLDER

The CPU Holder mounts to the underside of any 1" or 1.25" thick worksurface. The AU200CU is non-locking and has a track size of 17". This CPU holder has a weight capacity of 13lbs. This CPU holder has a plastic glide track style. The AU300CU is non-locking with a weight capacity of 17lbs and has a track size of 17" with a ball bearing style track. All CPU holders have a height range of 14.5"/22.5" and a width range of 3.5"/9.3".

WORKSURFACE STRETCHER BAR

Worksurface stretcher bar is additional structural support for unsupported worksurfaces of 54" or greater. It is 1 ½" H and the length of the stretcher bar is chosen based on the width of the worksurface. Be sure that there are no legs or panel mounted worksurface support brackets that may interfere with the stretcher bar.

PANEL-MOUNTED WHITEBOARDS

Panel-Mounted Whiteboards are available in two tile heights and in five tile widths. They are manufactured from steel and are powder-coated with white paint specially formulated for dry erase markers.

NOTE: Only Expo Markers are to be used on any Inscape Whiteboard. Whiteboards should be cleaned with Expo Eraser or a Microfiber cleaning cloth along with Expo Cleaning Solution which is formulated to remove residue from Expo Dry Erase Markers.

CROSSRAILS

Crossrails are available for order when a tile configuration requires a different mount of the tile from where crossrails are placed when shipped. These crossrails are based on the width of the panel as well as the thickness, either 2.75" or 3.5". Crossrails are shipped with mounting hardware as well as tile clips.

MODESTY PANELS

Modesty Panels are available in a variety of options including painted, Nuform, laminate and acrylic. Panels are available in Partial Height of 13.5" and Full Height of 24" versions and a number of widths. Calculations must be made to determine the correct width dimension of Modesty Panel should be specified to accommodate the desired space. All mounting hardware is included in the product code and are installed on-site.

TABLE MOUNTED FABRIC SCREEN

The Table Mounted Fabric Screen is constructed of a 1.5" thick extruded aluminum frame and is designed to provide modesty and privacy to adjacent work areas. This 37" H screen mounts onto a 1" or 1.25" thick worksurface and may be adjusted vertically to create the desired privacy or modesty. The tackable 0.5" thick core may be specified in any of Inscape's standard fabrics or COM. Height adjustable brackets allow for various screen height positions. It is recommended that the table mounted screen be installed 20" above the surface with 16" below. Table mounted screens cannot be attached at 90° connections to 3.5" thick frames.

TABLE MOUNTED ACRYLIC SCREENS

Table Mounted Acrylic Screens ship with standoff hardware to mount to a 1" or a 1.25" thick worksurface. The acrylic is a white finish with pre-drilled holes. When mounted, the screen extends 15.5" above the worksurface. Mounting hardware is included within the kit.

FREESTANDING TABLE SCREENS

The Freestanding Side Screen acts as a portable or stationary screen that separates two spaces adjacent to one another. The screen is made of 6mm thick frosted acrylic which is 13" H, seated in a painted aluminum extrusion, which can be painted any of Inscape's standard colors. The width of the screens is such that they are 5" less than the depth of our standard worksurfaces.

ADD-ON GLAZING

Add-on Glazing is manufactured from ¼" tempered glass. A ⅜" tempered glass is also available. Glazing may be mounted to the top of any equivalent Inscape System frame or combination of frames outlined in the Application Guide. Glazing is available in clear, gray, etched one or two sides and designer glass Strie options. Add-on Glazing includes top trim, glass mounting extrusion and specified glass. Add-on Glazing is specified based on the thickness of the panel.

NOTE: Hi-lo Add-on Glazing must be specified when installed directly adjacent to a higher panel at an inline situation only. The glaze and extrusion are inset on one side to allow for hi-lo vertical trim on the adjacent higher panel. If the situation calls for hi-lo on both sides, a special may be required. An Add-on Glazing alignment clip is included with each Add-on Glaze ordered.

WALL MOUNTED ACCESSORIES

Wall Mounted Accessories include tackboards, whiteboards and paper management rails. These accessories ship with mounting hardware and instructions on how to install them onto the wall. Re-enforcing of the wall should be taken into account when wall mounting any accessory for additional weight. Tackboards may be specified with any of our standard fabrics or a COM all are applied railroad orientation. The paper management rail may be specified with any of the colors found in the Color Guide.

Bin/Shelf-Mounted sorters install beneath overhead bins and shelves and hold literature, correspondence, notes, etc. Sorters are available in right and left-handed models and are easily repositioned by sliding horizontally along the length of the bin or shelf. Sorters ship in packages of three and may be painted in any of Inscape's color options. Bin and shelf sorters are specific to the unit they are being mounted on. Sorters are suitable for paper literature. Sliding Dividers may be placed in the overhead bin within a channel and slid to divide binders and other literature.

MAGNETIC WHITEBOARDS

Magnetic Whiteboards are available to mount on the side access tower. Available in 13.25" width only and two heights, the magnetic whiteboard is manufactured from steel and powder-coated with white paint formulated for use with dry-erase markers. Magnetic whiteboards include a 10.5" W marker tray.

NOTE: Only Expo Markers are to be used on any Inscape Whiteboard. Whiteboards should be cleaned with Expo Eraser or a Microfiber cleaning cloth along with Expo Cleaning Solution which is formulated to remove residue from Expo Dry Erase Markers.

HANGFILE BARS

Hangfile Bars are shipped as a pair and are used for 10.5", 12", 13.5", 15" and 16.5" pullout shelves/drawers.

INVIROMASS COUNTERWEIGHTS

Inviromass Counterweights for field installation "IMCW-30, IMCW-36 and IMCW-42" consist of one Inviromass plate and one retaining wire. These plates are to be field installed into lateral file cabinet by inserting the 30", 36" or 42" W retaining wire into holes in the left and right hand rear stripe's.

The "INCW" for field installation consists of two 24lbs steel plates. These are affixed to back interior of case using peel and stripe two way tape.

SYSTEM CARE KITS

System Care Kits are panel thickness specific. Included in this care kit is the following: panel hook and latch assembly, 2-way 90° connectors, tile clips, end of line plugs, Dekko electrical clips, inline connector and trim clips.

BACK PAINTED GLASS

Back Painted Glass is a 6mm tempered glass addition to the back of Planna Storage cases. This glass is installed on the back of the case with stand off assemblies and holes that are field drilled into the case. Glass is painted on one side and available in white. Mounting hardware included.

SUPERSTOR™ INSERTS

SuperStor™ Inserts may be purchased independently of a storage unit and field installed using #10 self-drilling 'Tek' screws. The pre slotted back panel of the insert accepts SuperStor™ Trays which are available in any of Inscape's standard paint colors plus textured finishes. Trays must be specified separately and for ease of specification are sold in packages: standard trays - package of 6, small trays - package of 3. The 30" insert is slotted to accept 12 Standard Trays (2 pkgs) and 3 Small Trays (1 pkg), the 36" insert is slotted to accept 18 Standard Trays (3 pkgs) and the 42" insert is slotted to accept 18 Standard Trays (3 pkgs) and 3 Small Trays (1 pkg).

PLANNA SUPPORT BRACKET

Planna support bracket is specified to be mounted on Planna rail and floats the worksurface off the bracket. Bracket is available in all standard paint colors. Bracket "snaps" into the rail without the need for tools. These are shipped as a pair and both must be installed per worksurface.

HAT CHANNEL

Hat channels are used to support a worksurface off of a 21" ID Planna storage case and are available in any of Inscape's standard paint finishes. They are nominal in height and support a worksurface at a standard 28.5" height.

LATERAL AND PEDESTAL RAIL KITS

Lateral and Pedestal Rail Kits are available for separate purchase to create alternative applications when mounted on standard Office Specialty cases. These kits must be field installed. Rail Kits consist of a pair of extruded aluminum rails painted in 'Aluminum Leaf' and a pair of mounting rails that act as a 'reveal' and secure the Planna Storage rails into a box substructure to support the Planna Storage 0.5" thick lateral top.

End anchor units must be 36" W. Specify CREDENZA STORAGE-KIT36 separately. Center units will be positioned back-to-back and may be 30", 36" or 42" W.

If Center Units = 30" W,
specify 2 x CREDENZA STORAGEKIT3615

If Center Units = 36" W,
specify 2 x CREDENZA STORAGEKIT36

If Center Units = 42" W,
specify 2 x CREDENZA STORAGEKIT3621

Using pre-configured or buildup cases with 36" I.D. (interior dimension) will provide finished height to top of worksurface of 43". Use adjustment in Planna Storage brackets to lower worksurface height to suit seating height.

LATERAL TOPS

The Lateral Tops are available in ½" and ¾" thick options. The ½" thick option has been designed for Planna Storage applications in freestanding, benching or private office applications (may be specified on any lateral case). When being specified with the top fully spanning the Planna Storage benching frame or partially, there are a number of tops to accommodate the clean visual of having a continuous top over the panel. Depths are 1.75" or 3.5" deeper than standard tops to accommodate the various Planna Storage benching applications. The 21.5" deep Planna Storage lateral tops work in conjunction with the two Planna Storage units which access electrical through the back of the case. The 3.5" gap created behind the case provides space for cables to be plugged in and routed into the case. The same concept may be applied when specifying lateral tops for Private Office applications and requiring an additional 3.5" deep top. The ¾" top is ideal for and freestanding lateral applications. These are NOT to be specified on Planna Storage cases.

CUSHION PROGRAM

The **Classic Cushion** is 1 ¼" thick CAL 117 compliant polyurethane foam with a 2.3 lb/ft. density. This upholstered cushion is balanced with a ¼" board and is attached to the pedestal top with heavy duty Velcro. The 5-pc construction, features double row top stitching on all seams, seen in fine upholstered pieces. The result provides crisp rectilinear styling.

The **Lite Cushion** is ¾" thick CAL 117 compliant polyurethane foam with a 2.3 lb/ft. density. This upholstered cushion is balanced with a ¼" board and is attached to the pedestal top with Velcro. Our Lite Cushion has seamless features allowing it to highlight the fabric details. The result provides a modern and simple look.

The Lite Cushion is available in the following Grade A fabrics only: Fedora, Glint, Pebble, Rancho & Script

Select from our graded upholstery program of solid color fabrics and vinyl's or choose COM option (Customers Own Material). To determine if a COM fabric has been pre-approved for use on our cushion topper, contact your Client Services Representative or go to inscapesolutions.com.

For application of all fabrics, both from our graded program as well as COM (Customers Own Material) please specify lay-up orientation at time of order. If lay-up instructions are not provided we will choose the direction to maximize our production. Refer to diagram for lay-up instructions. Please contact your Client Services Representative to confirm yardage requirements for your order. All COM fabric must be pre-approved. Your CSR can determine if your COM has already been pretested for application. A fully graded program has been set up for cushions. Various sizes of cushion have been designed for applications ranging from freestanding, benching and private office applications.

CUSHION APPLICATION NOTES

When ordering a Planna Storage cushion to lie flush next to a Planna Storage case with rail/lateral surface, select your Planna Storage case with 'no rails' option.

PEDESTAL FABRIC LAY UP INSTRUCTIONS

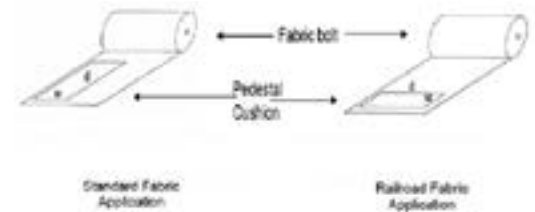



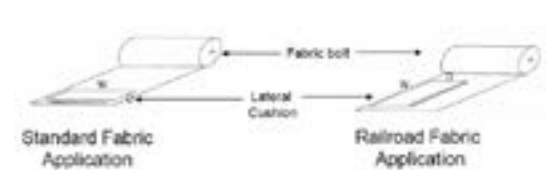

LATERAL FABRIC LAY UP INSTRUCTIONS



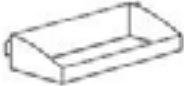

Due to the nature of the design and manufacture of our cushion, only approved fabrics will be accepted for application. For a description of the procedure required for COM fabric approval see sample 'Cushion COM Test Request' form found in the General Information section of this price list. This form can be downloaded from the Administration section of Insite or by contacting your Client Services Representative for assistance.

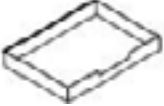
Please see Finishes section for COM calculator.

- Horizontal Paper Management accessories hang on panel mounted or wall hung paper management tile



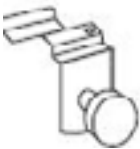

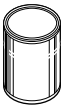
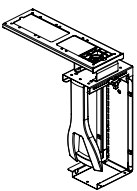
| | | Part number | H | W | Wt (lbs) | Neutral paint/ base price | Accent paint |
|---|--------------------------------|--|-------|------|----------|------------------------------|-----------------|
|  | Storage Compartment Acrylic | INSC4334 | 1 ½" | 3" | 0.1 | \$25 | — |
| | | INSC4534 | 1 ½" | 5" | 0.1 | \$27 | — |
| | | INSC4734 | 1 ½" | 7" | 0.1 | \$29 | — |
|  | Slanted Sorter | INHLHSS left-handed | 11 ¾" | 2 ¼" | 4 | \$76 | +\$11 |
| | | INHRHSS right-handed (illustrated) | 11 ¾" | 2 ¼" | 4 | \$76 | +\$11 |
|  | Storage Box | INBTSB | 2" | 12" | 2 | \$146 | +\$18 |
|  | Closed Shelf | INBTSHC | 2" | 12" | 2 | \$167 | +\$20 |
|  | Open Shelf | INBTSHF | 2" | 12" | 2 | \$111 | +\$15 |

- “2F” denotes use with 2 ¾" thick frame
“3F” denotes use with 3 ½" thick frame
- Pencil Drawer is available in black only
- Pencil Drawer installed depth is 15 ¼" and the extended depth is 26"
- CPU holder mounts to the underside of a worksurface (See Inscape System Application Guide)
- The AU200CU is non-locking and has a track size of 17". It has a weight capacity of 13lbs and a plastic glide track style.
- The AU300CU is non-locking and has a track size of 17". It has a weight capacity of 17lbs and a ball bearing style track.
- Both CPU holders have a height range of 14.5"/22.5" and a width range of 3.5"/9.3"



| | Part number | H | W | Wt (lbs) | Neutral paint/ base price | Accent paint |
|---|---|----------------------------|------------------------|----------|------------------------------|-----------------|
|  | Signage (Qty of 6) INPS2259-1 | 2 ¼" | 9" | 1 | \$105 | +\$13 |
|  | Coat Hook INCOATHOOK-3F INCOATHOOK-2F | — — | — — | 1 1 | \$31 \$31 | +\$7 +\$7 |
|  | Picture Hook INPICHOOK-3F INPICHOOK-2F | — — | — — | 1 1 | \$27 \$27 | +\$7 +\$7 |
|  | Pencil Drawer Undersurface mounted INFPD15 | — | 15" | 3 | \$84 | — |
|  | Touch-up paint for standard enamel finishes Specify finish. Can contains a half pint PAINT | — | — | 0.5 | \$45 | — |
|  | CPU Holder INAU200CU INAU300CU | 14.5"-22.5" 14.5"-22.5" | 3.5"-9.3" 3.5"-9.3" | 13 13 | \$383 \$466 | |
| | System Care Kit For use with 3 ½" T frames INCAREKT-3F INCAREKT-2F | — — | — — | — — | — — | \$139 \$115 |

NOTES

- Only Expo Markers are to be used on any Inscape Whiteboard. Whiteboards should be cleaned with Expo Eraser or a Microfiber cleaning cloth along with Expo Cleaning Solution which is formulated to remove residue from Expo Dry Erase Markers

| | | Part number | H | W | Wt (lbs) | List price |
|---|--|-----------------------|-------|-----|----------|------------|
|  | 13.5" H Panel Mounted Whiteboard For use with 3 1/2" T frames | INWHBD24135-3F | 13.5" | 24" | 10 | \$276 |
| | | INWHBD30135-3F | 13.5" | 30" | 13 | \$285 |
| | | INWHBD36135-3F | 13.5" | 36" | 14 | \$292 |
| | | INWHBD42135-3F | 13.5" | 42" | 16 | \$304 |
| | | INWHBD48135-3F | 13.5" | 48" | 18 | \$312 |
|  | 27" H Panel Mounted Whiteboard For use with 3 1/2" T frames | INWHBD2427-3F | 27" | 24" | 11 | \$366 |
| | | INWHBD3027-3F | 27" | 30" | 13 | \$375 |
| | | INWHBD3627-3F | 27" | 36" | 14 | \$383 |
| | | INWHBD4227-3F | 27" | 42" | 16 | \$391 |
| | | INWHBD4827-3F | 27" | 48" | 18 | \$401 |
|  | 13.5" H Panel Mounted Whiteboard For use with 2 3/4" T frames | INWHBD24135-2F | 13.5" | 24" | 10 | \$276 |
| | | INWHBD30135-2F | 13.5" | 30" | 13 | \$285 |
| | | INWHBD36135-2F | 13.5" | 36" | 14 | \$292 |
| | | INWHBD42135-2F | 13.5" | 42" | 16 | \$304 |
| | | INWHBD48135-2F | 13.5" | 48" | 18 | \$312 |
|  | 27" H Panel Mounted Whiteboard For use with 2 3/4" T frames | INWHBD2427-2F | 27" | 24" | 11 | \$366 |
| | | INWHBD3027-2F | 27" | 30" | 13 | \$375 |
| | | INWHBD3627-2F | 27" | 36" | 14 | \$383 |
| | | INWHBD4227-2F | 27" | 42" | 16 | \$391 |
| | | INWHBD4827-2F | 27" | 48" | 18 | \$401 |

- “2F” denotes use with 2 ¾" thick frame
- “3F” denotes use with 3 ½" thick frame
- Crossrails may be installed on a frame of the same thickness in pre-drilled locations in frame

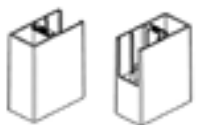
| | | Part number | H | W | Wt (lbs) | List price |
|---|--|-----------------------|---|-----|----------|------------|
|  | Crossrail For use with 3 ½" T frames Includes tile clips | INCRAIL18-3F | — | 18" | 1 | \$29 |
| | | INCRAIL24-3F | — | 24" | 1 | \$31 |
| | | INCRAIL30-3F | — | 30" | 1 | \$34 |
| | | INCRAIL36-3F | — | 36" | 1 | \$36 |
| | | INCRAIL42-3F | — | 42" | 2 | \$39 |
| | | INCRAIL48-3F | — | 48" | 2 | \$43 |
| | | INCRAIL54-3F | — | 54" | 2 | \$47 |
| | | INCRAIL60-3F | — | 60" | 2 | \$49 |
|  | Crossrail For use with 2 ¾" T frames Includes tile clips | INCRAIL18-2F | — | 18" | 1 | \$29 |
| | | INCRAIL24-2F | — | 24" | 1 | \$31 |
| | | INCRAIL30-2F | — | 30" | 1 | \$34 |
| | | INCRAIL36-2F | — | 36" | 1 | \$36 |
| | | INCRAIL42-2F | — | 42" | 2 | \$39 |
| | | INCRAIL48-2F | — | 48" | 2 | \$43 |
| | | INCRAIL54-2F | — | 54" | 2 | \$47 |
| | | INCRAIL60-2F | — | 60" | 2 | \$49 |
|  | Rectangular Glide (Pair) Gray finish | INFRMREC-GLIDE | — | — | — | \$51 |

- Modesty panels are available in a variety of materials and mounting options correspond with each variety
- Modesty panels mount to the underside of worksurface and are field installed
- See Application Guide for specific dimension detailed applications
- All hardware included
- Modesty panel use with a Height Adjustable Table, specify modesty panel 12" shorter in length than the surface
- Nuform finish is on one side with white backer

NOTES

In order to get a total cost on products when upcharges are present take the list price of the product number and add the upcharge cost shown to the list price.

For example:

Product INMDPNP30 in Grande 1 laminate would be \$312 +\$101

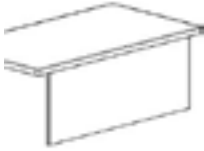

| | Part number | H | W | Wt (lbs) | Neutral paint/ base price | Accent paint |
|---|------------------|-------|-----|----------|------------------------------|-----------------|
| Painted Partial Height Modesty Panel | INMDPNP30 | 13 ½" | 30" | 5 | \$135 | +\$17 |
| | INMDPNP33 | 13 ½" | 33" | 5.5 | \$139 | +\$17 |
| | INMDPNP36 | 13 ½" | 36" | 6 | \$141 | +\$17 |
| | INMDPNP39 | 13 ½" | 39" | 6.5 | \$144 | +\$18 |
| | INMDPNP42 | 13 ½" | 42" | 7 | \$147 | +\$18 |
| | INMDPNP45 | 13 ½" | 45" | 7.5 | \$152 | +\$18 |
| | INMDPNP48 | 13 ½" | 48" | 8 | \$159 | +\$19 |
| | INMDPNP51 | 13 ½" | 51" | 8.5 | \$161 | +\$19 |
| | INMDPNP54 | 13 ½" | 54" | 9 | \$164 | +\$19 |
| | INMDPNP57 | 13 ½" | 57" | 9.5 | \$167 | +\$20 |
| | INMDPNP60 | 13 ½" | 60" | 10 | \$169 | +\$20 |
| | INMDPNP63 | 13 ½" | 63" | 10.5 | \$171 | +\$20 |
| | INMDPNP66 | 13 ½" | 66" | 11 | \$173 | +\$20 |
| | INMDPNP69 | 13 ½" | 69" | 11.5 | \$174 | +\$20 |
| INMDPNP72 | 13 ½" | 72" | 12 | \$178 | +\$21 | |



| | Part number | H | W | Wt (lbs) | Nuform classic/ laminate/base price | Nuform select | Grade 1 laminate | Accent paint |
|---|------------------|-------|-----|----------|--|------------------|---------------------|-----------------|
| Wood Core Partial Height Modesty Panel | INMDPNW30 | 13 ½" | 30" | 12 | \$312 | +\$35 | +\$101 | +\$33 |
| | INMDPNW33 | 13 ½" | 33" | 13 | \$333 | +\$37 | +\$107 | +\$35 |
| | INMDPNW36 | 13 ½" | 36" | 14 | \$342 | +\$39 | +\$111 | +\$36 |
| | INMDPNW39 | 13 ½" | 39" | 15 | \$382 | +\$44 | +\$125 | +\$42 |
| | INMDPNW42 | 13 ½" | 42" | 16 | \$389 | +\$45 | +\$127 | +\$43 |
| | INMDPNW45 | 13 ½" | 45" | 17.5 | \$399 | +\$46 | +\$130 | +\$44 |
| | INMDPNW48 | 13 ½" | 48" | 19 | \$405 | +\$47 | +\$131 | +\$44 |
| | INMDPNW51 | 13 ½" | 51" | 20 | \$444 | +\$50 | +\$143 | +\$48 |
| | INMDPNW54 | 13 ½" | 54" | 21 | \$452 | +\$51 | +\$145 | +\$48 |
| | INMDPNW57 | 13 ½" | 57" | 22 | \$463 | +\$52 | +\$148 | +\$49 |
| | INMDPNW60 | 13 ½" | 60" | 23.5 | \$485 | +\$54 | +\$158 | +\$51 |
| | INMDPNW63 | 13 ½" | 63" | 24.5 | \$566 | +\$63 | +\$182 | +\$59 |
| | INMDPNW66 | 13 ½" | 66" | 26 | \$590 | +\$66 | +\$191 | +\$61 |
| | INMDPNW69 | 13 ½" | 69" | 27 | \$612 | +\$69 | +\$198 | +\$63 |
| | INMDPNW72 | 13 ½" | 72" | 28 | \$637 | +\$71 | +\$206 | +\$65 |
| | INMDPNW75 | 13 ½" | 75" | 29 | \$709 | +\$79 | +\$228 | +\$72 |
| | INMDPNW78 | 13 ½" | 78" | 30.5 | \$714 | +\$80 | +\$231 | +\$73 |
| | INMDPNW81 | 13 ½" | 81" | 31.5 | \$722 | +\$81 | +\$234 | +\$73 |
| | INMDPNW84 | 13 ½" | 84" | 33 | \$726 | +\$81 | +\$235 | +\$74 |
| | INMDPNW87 | 13 ½" | 87" | 34 | \$733 | +\$83 | +\$237 | +\$74 |
| INMDPNW90 | 13 ½" | 90" | 35 | \$737 | +\$83 | +\$238 | +\$76 | |

- Modesty panels are available in a variety of materials and mounting options correspond with each variety
- Modesty panels mount to the underside of worksurface and are field installed
- See Application Guide for specific dimension detailed applications
- All hardware included
- Modesty panel use with a Height Adjustable Table, specify modesty panel 12" shorter in length than the surface
- Acrylic Partial Height Modesty Panel comes in white acrylic only

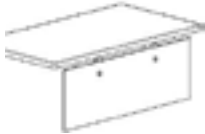

| | Part number | H | W | Wt (lbs) | Neutral paint/ base price | Accent paint |
|--------------------------------------|------------------|---------|-----|----------|------------------------------|-----------------|
| Acrylic Partial Height Modesty Panel | INMDPNA30 | 13 1/2" | 30" | 4 | \$510 | +\$53 |
| | INMDPNA33 | 13 1/2" | 33" | 4.5 | \$515 | +\$54 |
| | INMDPNA36 | 13 1/2" | 36" | 5 | \$523 | +\$54 |
| | INMDPNA39 | 13 1/2" | 39" | 5.5 | \$529 | +\$56 |
| | INMDPNA42 | 13 1/2" | 42" | 6 | \$535 | +\$56 |
| | INMDPNA45 | 13 1/2" | 45" | 6 | \$547 | +\$57 |
| | INMDPNA48 | 13 1/2" | 48" | 6.5 | \$552 | +\$58 |
| | INMDPNA51 | 13 1/2" | 51" | 7 | \$576 | +\$60 |
| | INMDPNA54 | 13 1/2" | 54" | 7.5 | \$602 | +\$62 |
| | INMDPNA57 | 13 1/2" | 57" | 8 | \$625 | +\$64 |
| | INMDPNA60 | 13 1/2" | 60" | 8 | \$657 | +\$67 |
| | INMDPNA63 | 13 1/2" | 63" | 8.5 | \$686 | +\$70 |
| | INMDPNA66 | 13 1/2" | 66" | 9 | \$720 | +\$73 |
| | INMDPNA69 | 13 1/2" | 69" | 9.5 | \$749 | +\$77 |
| | INMDPNA72 | 13 1/2" | 72" | 10 | \$782 | +\$81 |
| | INMDPNA75 | 13 1/2" | 75" | 10 | \$796 | +\$84 |
| | INMDPNA78 | 13 1/2" | 78" | 10.5 | \$815 | +\$85 |
| | INMDPNA81 | 13 1/2" | 81" | 11 | \$831 | +\$87 |
| | INMDPNA84 | 13 1/2" | 84" | 11.5 | \$849 | +\$88 |
| | INMDPNA87 | 13 1/2" | 87" | 12 | \$867 | +\$90 |
| INMDPNA90 | 13 1/2" | 90" | 12 | \$885 | +\$91 | |

- Modesty panels are available in a variety of materials and mounting options correspond with each variety
- Modesty panels mount to the underside of worksurface and are field installed
- See Application Guide for specific dimension detailed applications
- All hardware included
- Modesty panel use with a Height Adjustable Table, specify modesty panel 12" shorter in length than the surface
- Nuform finish is on one side with white backer

NOTES

In order to get a total cost on products when upcharges are present take the list price of the product number and add the upcharge cost shown to the list price.

For example:

Product INMDFHPNW30 in Grade 1 laminate would be \$401 +\$130



Wood Core Full Height Modesty Panel

| Part number | H | W | Wt (lbs) | Nuform classic/ laminate/base price | Nuform select | Grade 1 laminate | Accent paint |
|--------------------|-----|-----|----------|--|------------------|---------------------|-----------------|
| INMDFHPNW30 | 24" | 30" | 21.5 | \$401 | +\$46 | +\$130 | +\$44 |
| INMDFHPNW33 | 24" | 33" | 23.6 | \$437 | +\$50 | +\$141 | +\$47 |
| INMDFHPNW36 | 24" | 36" | 25.8 | \$445 | +\$50 | +\$144 | +\$48 |
| INMDFHPNW39 | 24" | 39" | 27.9 | \$509 | +\$58 | +\$165 | +\$53 |
| INMDFHPNW42 | 24" | 42" | 30.1 | \$519 | +\$59 | +\$168 | +\$54 |
| INMDFHPNW45 | 24" | 45" | 32.3 | \$465 | +\$52 | +\$151 | +\$49 |
| INMDFHPNW48 | 24" | 48" | 34.4 | \$540 | +\$61 | +\$174 | +\$57 |
| INMDFHPNW51 | 24" | 51" | 36.6 | \$668 | +\$74 | +\$215 | +\$69 |
| INMDFHPNW54 | 24" | 54" | 38.7 | \$680 | +\$77 | +\$219 | +\$70 |
| INMDFHPNW57 | 24" | 57" | 40.9 | \$688 | +\$77 | +\$221 | +\$71 |
| INMDFHPNW60 | 24" | 60" | 47 | \$708 | +\$79 | +\$228 | +\$72 |
| INMDFHPNW63 | 24" | 63" | 45.2 | \$737 | +\$83 | +\$238 | +\$76 |
| INMDFHPNW66 | 24" | 66" | 47.3 | \$756 | +\$85 | +\$243 | +\$77 |
| INMDFHPNW69 | 24" | 69" | 49.5 | \$778 | +\$87 | +\$250 | +\$81 |
| INMDFHPNW72 | 24" | 72" | 51.7 | \$793 | +\$89 | +\$255 | +\$83 |
| INMDFHPNW75 | 24" | 75" | 52.8 | \$906 | +\$101 | +\$291 | +\$93 |
| INMDFHPNW78 | 24" | 78" | 56 | \$912 | +\$102 | +\$293 | +\$94 |
| INMDFHPNW81 | 24" | 81" | 58.1 | \$917 | +\$102 | +\$294 | +\$94 |
| INMDFHPNW84 | 24" | 84" | 60.3 | \$924 | +\$103 | +\$296 | +\$96 |
| INMDFHPNW87 | 24" | 87" | 62.4 | \$929 | +\$103 | +\$299 | +\$96 |
| INMDFHPNW90 | 24" | 90" | 64.6 | \$939 | +\$104 | +\$302 | +\$97 |

- Table mounted screens mount to worksurfaces
- Adjustable Framed Table Mounted Screens have height adjustment for above worksurface privacy and below the worksurface modesty. It is recommended that this screen be installed with a max of 20" above the surface.
- Table Mounted Acrylic Screens have approx. 16" of screen above the surface and approx. 3" below the surface
- Freestanding Table Screen is made of 6mm thick frosted acrylic which is 13" H, seated in a painted aluminum extrusion, which can be painted any of Inscape's standard colors. This screen is 5" less in depth than depth of worksurface it will be placed on
- Hardware is included

NOTES

In order to get a total cost on products when upcharges are present take the list price of the product number and add the upcharge cost shown to the list price.

For example:

Product MST3736 in Grade 5 Fabric would be \$607 +\$156

Product SWTMS48 in White Acrylic would be \$867 +\$103

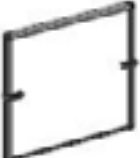
| | Part number | H | W | Wt (lbs) | Grade 1/ COM/ base price | Grade 2 | Grade 3 | Grade 4 | Grade 5 | Grade 6 | Grade 7 | Grade 8 | Accent paint |
|---|----------------|-----|-----|----------|--------------------------------|---------|---------|---------|---------|---------|---------|---------|-----------------|
|  | MST3736 | 37" | 36" | 13 | \$607 | +\$58 | +\$90 | — | +\$156 | +\$289 | +\$426 | — | +\$63 |
| | MST3742 | 37" | 42" | 15 | \$633 | +\$59 | +\$91 | — | +\$156 | +\$293 | +\$430 | — | +\$65 |
| | MST3748 | 37" | 48" | 16 | \$658 | +\$64 | +\$92 | — | +\$157 | +\$296 | +\$435 | — | +\$67 |
| | MST3754 | 37" | 54" | 18 | \$681 | +\$66 | +\$98 | — | +\$160 | +\$305 | +\$444 | — | +\$70 |
| | MST3760 | 37" | 60" | 19 | \$705 | +\$72 | +\$103 | — | +\$160 | +\$312 | +\$455 | — | +\$72 |

37" H Adjustable Framed
Table Mounted Screen
Tackable

| | Part number | H | W | Wt (lbs) | Clear acrylic/ base price | White acrylic | Frosted acrylic |
|---|----------------|-----|-----|----------|------------------------------|------------------|--------------------|
|  | SWTMS48 | 20" | 48" | 4 | \$867 | +\$103 | +\$103 |
| | SWTMS54 | 20" | 54" | 5 | \$1359 | +\$214 | +\$214 |
| | SWTMS60 | 20" | 60" | 6 | \$1575 | +\$213 | +\$213 |

Table Mounted Acrylic
Screen

| | Part number | H | W | Wt (lbs) | Neutral paint/ base price | Accent paint |
|---|----------------|-----|-----|----------|------------------------------|-----------------|
|  | INSPS24 | 13" | 19" | 2 | \$121 | +\$16 |
| | INSPS30 | 13" | 25" | 2.5 | \$169 | +\$20 |
| | INSPS32 | 13" | 28" | 3 | \$177 | +\$20 |
| | INSPS36 | 13" | 31" | 3.5 | \$183 | +\$21 |

Freestanding Table Screen

- Table mounted screens mount to worksurfaces
- Table Mounted Screen/Modesty has 14" of the tackboard mounted above the surface and 13 ½" below
- Flat and Curved Table Mounted Metal Screens include an optional tackboard which, when selected, ships separately
- Flat Table Mounted Metal Screens are for use with any surface
- Curved Table Mounted Metal Screens are for use with INLAK Freestanding and Mobile Tables only
- Curved Table Mounted Metal Screens are for use on worksurfaces with a width of 48" or 60" depending on screen chosen
- Flat and Curved Table Mounted Metal Screens have 14 ¼" of the screens mounted above the surface and 6" below
- Hardware is included

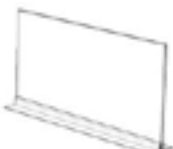
NOTES

In order to get a total cost on products when upcharges are present take the list price of the product number and add the upcharge cost shown to the list price.

For example:

Product INTMSF2948 in Grade B Fabric would be \$1281 +\$182

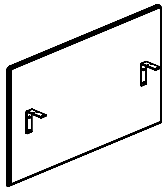
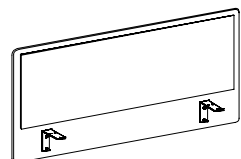

Table Mounted Screen/
Modesty
Tackable

| Part number | H | W | Wt (lbs) | Grade A/ base price | Grade B/ COM | Grade C | Grade D | Grade E | Grade F | Accent paint |
|-------------------|-----|-----|----------|------------------------|-----------------|---------|---------|---------|---------|-----------------|
| INTMSF2948 | 29" | 48" | — | \$1281 | +\$182 | +\$499 | +\$967 | +\$1165 | +\$1590 | +\$130 |
| INTMSF2954 | 29" | 54" | — | \$1300 | +\$354 | +\$691 | +\$1170 | +\$1394 | +\$1956 | +\$132 |
| INTMSF2960 | 29" | 60" | — | \$1387 | +\$405 | +\$781 | +\$1306 | +\$1555 | +\$2175 | +\$141 |



Flat Table Mounted Metal
Screen

| Part number | H | W | Screen list/base price | Tackboard Fabric options | | | | | | | Accent paint | |
|--------------------|-------|-----|------------------------------|---------------------------|-----------------|---------|---------|---------|---------|---------|-----------------|---------|
| | | | | No fabric tackboard | Grade 1/ COM | Grade 2 | Grade 3 | Grade 4 | Grade 5 | Grade 6 | | Grade 7 |
| INWMMFS2146 | 21 ¼" | 46" | \$785 | -\$262 | +\$0 | +\$80 | +\$125 | — | — | — | +\$589 | +\$86 |
| INWMMFS2158 | 21 ¼" | 58" | \$896 | -\$273 | +\$0 | +\$90 | +\$141 | — | — | — | +\$589 | +\$97 |

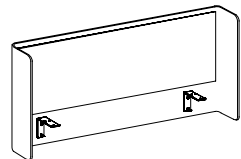

Curved Table Mounted
Metal Screen

| | | | | | | | | | | | | |
|--------------------|-------|-----|--------|--------|------|--------|--------|---|---|---|--------|--------|
| INWMMCS2148 | 21 ¼" | 48" | \$862 | -\$262 | +\$0 | +\$88 | +\$135 | — | — | — | +\$644 | +\$93 |
| INWMMCS2160 | 21 ¼" | 60" | \$1038 | -\$273 | +\$0 | +\$103 | +\$162 | — | — | — | +\$767 | +\$111 |

Accessories

Add-on Glazing
3 1/2" T

System

- “2F” denotes use with 2 3/4" thick frame
“3F” denotes use with 3 1/2" thick frame
- Add-on Glazing comes complete with mounting hardware and top cap
- Add-on Glazing may span multiple frames according to guidelines set in the “Inscape System Application Guide”
- One glaze Alignment clip is included with each Add-on Glazing
- Add-on Glazing up to 60" W require two additional Jesters to be specified if spanning multiple frames (ie a 60" W AOG installed on 2-30" frames)
- **Tapered is not available in 66" or wider**
- **List/Base for 0.25" thick is clear glass**
- **0.38" thick is NOT available in tapered**

NOTES

In order to get a total cost on products when upcharges are present take the list price of the product number and add the upcharge cost shown to the list price.

For example:

Product INAG6.7518-3F 0.25" thick glass with Gray would be \$160 +\$92

The same product upgraded to 0.38" thick glass would be \$160 +\$79 +\$212

| Part number | W | List/base / 0.25" thick glazing price | Glazing thickness option | 0.25" thick finish options | | | | 0.38" thick finish options | | | Accent paint | |
|---|----------------------|---------------------------------------|--------------------------|----------------------------|------|---------------|---------------|----------------------------|------|---------------|--------------|-------|
| | | | 0.38" thick glazing | Clear | Gray | Etched 1 side | Etched 2 side | Clear | Gray | Etched 1 side | | |
|  6.75" H Add-On Glazing For use with 3 1/2" T frames | INAG6.7518-3F | 18" | \$160 | +\$79 | +\$0 | +\$92 | +\$92 | +\$168 | +\$0 | +\$212 | +\$212 | +\$19 |
| | INAG6.7524-3F | 24" | \$198 | +\$98 | +\$0 | +\$89 | +\$89 | +\$169 | +\$0 | +\$225 | +\$225 | +\$22 |
| | INAG6.7530-3F | 30" | \$225 | +\$112 | +\$0 | +\$108 | +\$108 | +\$213 | +\$0 | +\$273 | +\$273 | +\$25 |
| | INAG6.7536-3F | 36" | \$248 | +\$124 | +\$0 | +\$119 | +\$119 | +\$260 | +\$0 | +\$295 | +\$295 | +\$27 |
| | INAG6.7542-3F | 42" | \$265 | +\$132 | +\$0 | +\$124 | +\$124 | +\$270 | +\$0 | +\$312 | +\$312 | +\$29 |
| | INAG6.7548-3F | 48" | \$286 | +\$140 | +\$0 | +\$128 | +\$128 | +\$276 | +\$0 | +\$329 | +\$329 | +\$31 |
| | INAG6.7554-3F | 54" | \$305 | +\$152 | +\$0 | +\$131 | +\$131 | +\$280 | +\$0 | +\$343 | +\$343 | +\$33 |
| | INAG6.7560-3F | 60" | \$329 | +\$164 | +\$0 | +\$144 | +\$144 | +\$310 | +\$0 | +\$376 | +\$376 | +\$35 |
| | INAG6.7566-3F | 66" | \$341 | +\$168 | +\$0 | +\$179 | +\$179 | +\$336 | +\$0 | +\$434 | +\$434 | +\$36 |
| | INAG6.7572-3F | 72" | \$358 | +\$178 | +\$0 | +\$199 | +\$199 | +\$368 | +\$0 | +\$471 | +\$471 | +\$37 |
| | INAG6.7578-3F | 78" | \$456 | +\$223 | +\$0 | +\$154 | +\$154 | +\$316 | +\$0 | +\$453 | +\$453 | +\$49 |
| | INAG6.7584-3F | 84" | \$533 | +\$263 | +\$0 | +\$129 | +\$129 | +\$282 | +\$0 | +\$453 | +\$453 | +\$56 |
| | INAG6.7590-3F | 90" | \$611 | +\$302 | +\$0 | +\$102 | +\$102 | +\$250 | +\$0 | +\$453 | +\$453 | +\$63 |
| | INAG6.7596-3F | 96" | \$688 | +\$340 | +\$0 | +\$77 | +\$77 | +\$218 | +\$0 | +\$453 | +\$453 | +\$71 |

Accessories

Add-on Glazing
3 1/2" T

System

- “2F” denotes use with 2 3/4" thick frame
“3F” denotes use with 3 1/2" thick frame
- Add-on Glazing comes complete with mounting hardware and top cap
- Add-on Glazing may span multiple frames according to guidelines set in the “Inscope System Application Guide”
- One glaze Alignment clip is included with each Add-on Glazing
- Add-on Glazing up to 60" W require two additional Jesters to be specified if spanning multiple frames (ie a 60" W AOG installed on 2-30" frames)
- **Tapered is not available in 66" or wider**
- **List/Base for 0.25" thick is clear glass**
- **0.38" thick is NOT available in tapered**

NOTES

In order to get a total cost on products when upcharges are present take the list price of the product number and add the upcharge cost shown to the list price.



For example:

Product INAG13.518-3F 0.25" thick glass with Gray would be \$169 +\$88

The same product upgraded to 0.38" thick glass would be \$169 +\$86 +\$210

| Part number | W | List/base / 0.25" thick glazing price | Glazing thickness option | 0.25" thick finish options | | | | 0.38" thick finish options | | | Accent paint | |
|---|----------------------|---------------------------------------|--------------------------|----------------------------|------|---------------|---------------|----------------------------|------|---------------|--------------|-------|
| | | | 0.38" thick glazing | Clear | Gray | Etched 1 side | Etched 2 side | Clear | Gray | Etched 1 side | | |
|  | INAG13.518-3F | 18" | \$169 | +\$86 | +\$0 | +\$88 | +\$88 | +\$161 | +\$0 | +\$210 | +\$210 | +\$20 |
| | INAG13.524-3F | 24" | \$200 | +\$99 | +\$0 | +\$90 | +\$90 | +\$171 | +\$0 | +\$227 | +\$227 | +\$22 |
| | INAG13.530-3F | 30" | \$227 | +\$114 | +\$0 | +\$112 | +\$112 | +\$214 | +\$0 | +\$277 | +\$277 | +\$25 |
| | INAG13.536-3F | 36" | \$256 | +\$128 | +\$0 | +\$133 | +\$133 | +\$258 | +\$0 | +\$324 | +\$324 | +\$27 |
| | INAG13.542-3F | 42" | \$287 | +\$142 | +\$0 | +\$156 | +\$156 | +\$301 | +\$0 | +\$371 | +\$371 | +\$31 |
| | INAG13.548-3F | 48" | \$317 | +\$157 | +\$0 | +\$178 | +\$178 | +\$343 | +\$0 | +\$421 | +\$421 | +\$33 |
| | INAG13.554-3F | 54" | \$347 | +\$171 | +\$0 | +\$199 | +\$199 | +\$383 | +\$0 | +\$465 | +\$465 | +\$36 |
| | INAG13.560-3F | 60" | \$376 | +\$185 | +\$0 | +\$220 | +\$220 | +\$427 | +\$0 | +\$513 | +\$513 | +\$42 |
| | INAG13.566-3F | 66" | \$404 | +\$200 | +\$0 | +\$245 | +\$245 | +\$459 | +\$0 | +\$561 | +\$561 | +\$44 |
| | INAG13.572-3F | 72" | \$470 | +\$229 | +\$0 | +\$220 | +\$220 | +\$435 | +\$0 | +\$560 | +\$560 | +\$50 |
| | INAG13.578-3F | 78" | \$535 | +\$264 | +\$0 | +\$208 | +\$208 | +\$413 | +\$0 | +\$571 | +\$571 | +\$56 |
| | INAG13.584-3F | 84" | \$604 | +\$296 | +\$0 | +\$196 | +\$196 | +\$393 | +\$0 | +\$586 | +\$586 | +\$62 |
| | INAG13.590-3F | 90" | \$671 | +\$331 | +\$0 | +\$173 | +\$173 | +\$371 | +\$0 | +\$586 | +\$586 | +\$69 |
| | INAG13.596-3F | 96" | \$739 | +\$366 | +\$0 | +\$160 | +\$160 | +\$348 | +\$0 | +\$599 | +\$599 | +\$76 |

13.5" H Add-On Glazing
For use with 3 1/2" T frames

| | Part number | List price |
|---|-----------------------|------------|
|  | QCCLIPASSY-3F | \$9 |
|  | QCCLIPASSY-3FT | \$8 |

Accessories

Add-on Glazing
2 3/4" T

System

- "2F" denotes use with 2 3/4" thick frame
"3F" denotes use with 3 1/2" thick frame
- Add-on Glazing comes complete with mounting hardware and top cap
- Add-on Glazing may span multiple frames according to guidelines set in the "Inscape System Application Guide"
- One glaze Alignment clip is included with each Add-on Glazing
- Add-on Glazing up to 60" W require two additional Jesters to be specified if spanning multiple frames (ie a 60" W AOG installed on 2-30" frames)
- **Tapered is not available in 2 3/4" T**
- **List/Base for 0.25" thick is clear glass**
- **0.38" thick is NOT available in tapered**



NOTES

In order to get a total cost on products when upcharges are present take the list price of the product number and add the upcharge cost shown to the list price.

For example:

Product INAG6.7518-2F 0.25" thick glass with Gray would be \$160 +\$92

The same product upgraded to 0.38" thick glass would be \$160 +\$79 +\$212

| Part number | W | List/base / 0.25" thick glazing price | Glazing thickness option | 0.25" thick finish options | | | | 0.38" thick finish options | | | Accent paint | |
|---|---------------|---------------------------------------|--------------------------|----------------------------|--------|---------------|---------------|----------------------------|--------|---------------|--------------|-------|
| | | | 0.38" thick glazing | Clear | Gray | Etched 1 side | Etched 2 side | Clear | Gray | Etched 1 side | | |
|  6.75" H Add-On Glazing For use with 2 3/4" T frames | INAG6.7518-2F | 18" | \$160 | +\$79 | +\$0 | +\$92 | +\$92 | +\$168 | +\$0 | +\$212 | +\$212 | +\$19 |
| | INAG6.7524-2F | 24" | \$198 | +\$98 | +\$0 | +\$89 | +\$89 | +\$169 | +\$0 | +\$225 | +\$225 | +\$22 |
| | INAG6.7530-2F | 30" | \$225 | +\$112 | +\$0 | +\$108 | +\$108 | +\$213 | +\$0 | +\$273 | +\$273 | +\$25 |
| | INAG6.7536-2F | 36" | \$248 | +\$124 | +\$0 | +\$119 | +\$119 | +\$260 | +\$0 | +\$295 | +\$295 | +\$27 |
| | INAG6.7542-2F | 42" | \$265 | +\$132 | +\$0 | +\$124 | +\$124 | +\$270 | +\$0 | +\$312 | +\$312 | +\$29 |
| | INAG6.7548-2F | 48" | \$286 | +\$140 | +\$0 | +\$128 | +\$128 | +\$276 | +\$0 | +\$329 | +\$329 | +\$31 |
| | INAG6.7554-2F | 54" | \$305 | +\$152 | +\$0 | +\$131 | +\$131 | +\$280 | +\$0 | +\$343 | +\$343 | +\$33 |
| | INAG6.7560-2F | 60" | \$329 | +\$164 | +\$0 | +\$144 | +\$144 | +\$310 | +\$0 | +\$376 | +\$376 | +\$35 |
| | INAG6.7566-2F | 66" | \$341 | +\$168 | +\$0 | +\$179 | +\$179 | +\$336 | +\$0 | +\$434 | +\$434 | +\$36 |
| | INAG6.7572-2F | 72" | \$358 | +\$178 | +\$0 | +\$199 | +\$199 | +\$368 | +\$0 | +\$471 | +\$471 | +\$37 |
| | INAG6.7578-2F | 78" | \$456 | +\$223 | +\$0 | +\$154 | +\$154 | +\$316 | +\$0 | +\$453 | +\$453 | +\$49 |
| | INAG6.7584-2F | 84" | \$533 | +\$263 | +\$0 | +\$129 | +\$129 | +\$282 | +\$0 | +\$453 | +\$453 | +\$56 |
| | INAG6.7590-2F | 90" | \$611 | +\$302 | +\$0 | +\$102 | +\$102 | +\$250 | +\$0 | +\$453 | +\$453 | +\$63 |
| INAG6.7596-2F | 96" | \$688 | +\$340 | +\$0 | +\$77 | +\$77 | +\$218 | +\$0 | +\$453 | +\$453 | +\$71 | |
|  13.5" H Add-On Glazing For use with 2 3/4" T frames | INAG13.518-2F | 18" | \$169 | +\$86 | +\$0 | +\$88 | +\$88 | +\$161 | +\$0 | +\$210 | +\$210 | +\$20 |
| | INAG13.524-2F | 24" | \$200 | +\$99 | +\$0 | +\$90 | +\$90 | +\$171 | +\$0 | +\$227 | +\$227 | +\$22 |
| | INAG13.530-2F | 30" | \$227 | +\$114 | +\$0 | +\$112 | +\$112 | +\$214 | +\$0 | +\$277 | +\$277 | +\$25 |
| | INAG13.536-2F | 36" | \$256 | +\$128 | +\$0 | +\$133 | +\$133 | +\$258 | +\$0 | +\$324 | +\$324 | +\$27 |
| | INAG13.542-2F | 42" | \$287 | +\$142 | +\$0 | +\$156 | +\$156 | +\$301 | +\$0 | +\$371 | +\$371 | +\$31 |
| | INAG13.548-2F | 48" | \$317 | +\$157 | +\$0 | +\$178 | +\$178 | +\$343 | +\$0 | +\$421 | +\$421 | +\$33 |
| | INAG13.554-2F | 54" | \$347 | +\$171 | +\$0 | +\$199 | +\$199 | +\$383 | +\$0 | +\$465 | +\$465 | +\$36 |
| | INAG13.560-2F | 60" | \$376 | +\$185 | +\$0 | +\$220 | +\$220 | +\$427 | +\$0 | +\$513 | +\$513 | +\$42 |
| | INAG13.566-2F | 66" | \$404 | +\$200 | +\$0 | +\$245 | +\$245 | +\$459 | +\$0 | +\$561 | +\$561 | +\$44 |
| | INAG13.572-2F | 72" | \$470 | +\$229 | +\$0 | +\$220 | +\$220 | +\$470 | +\$0 | +\$560 | +\$560 | +\$50 |
| | INAG13.578-2F | 78" | \$535 | +\$264 | +\$0 | +\$208 | +\$208 | +\$413 | +\$0 | +\$571 | +\$571 | +\$56 |
| | INAG13.584-2F | 84" | \$604 | +\$296 | +\$0 | +\$196 | +\$196 | +\$393 | +\$0 | +\$586 | +\$586 | +\$62 |
| | INAG13.590-2F | 90" | \$671 | +\$331 | +\$0 | +\$173 | +\$173 | +\$371 | +\$0 | +\$586 | +\$586 | +\$69 |
| INAG13.596-2F | 96" | \$739 | +\$366 | +\$0 | +\$160 | +\$160 | +\$348 | +\$0 | +\$599 | +\$599 | +\$76 | |

Accessories

Add-on Glazing
2 3/4" T





- "2F" denotes use with 2 3/4" thick frame
- "3F" denotes use with 3 1/2" thick frame
- Add-on Glazing comes complete with mounting hardware and top cap
- Add-on Glazing may span multiple frames according to guidelines set in the "Inscape System Application Guide"
- One glaze Alignment clip is included with each Add-on Glazing
- Add-on Glazing up to 60"w require two additional Jesters to be specified if spanning multiple frames (ie a 60"w AOG installed on 2-30" frames)
- **Tapered is not available in 2 3/4" T**
- **List/Base for 0.25" thick is clear glass**
- **0.38" thick is NOT available in tapered**

| | Part number | List price |
|--|----------------------|------------|
|  <p>Add-On Glazing Top Cap Clip for 2 3/4" T Flat Trim Applications</p> | QCCLIPASSY-2F | \$9 |

- Wall mounted accessories may be specified to mount to any drywall application
- Additional wall bracing should be taken into consideration when ordering any wall hung component which will carry additional weight
- Ensure wall is adequately constructed and/or braced to ensure a secure installation
- All wall mount brackets are included

NOTES

- Only Expo Markers are to be used on any Inscape Whiteboard. Whiteboards should be cleaned with Expo Eraser or a Microfiber cleaning cloth along with Expo Cleaning Solution which is formulated to remove residue from Expo Dry Erase Markers

| | | Part number | H | W | Wt (lbs) | | List price |
|---|--|---------------------|--------|-----|----------|-------|------------|
|  | 13.5" H Wall Mount Whiteboard Tile | IN13.5WB30W | 13.5" | 30" | 3 | | \$245 |
| | | IN13.5WB36W | 13.5" | 36" | 4 | | \$250 |
| | | IN13.5WB42W | 13.5" | 42" | 4 | | \$254 |
| | | IN13.5WB48W | 13.5" | 48" | 5 | | \$258 |
| | | IN13.5WB54W | 13.5" | 54" | 6 | | \$260 |
| | | IN13.5WB60W | 13.5" | 60" | 6 | | \$265 |
|  | 20.25" H Wall Mount Whiteboard Tile | IN20.25WB30W | 20.25" | 30" | 5 | | \$254 |
| | | IN20.25WB36W | 20.25" | 36" | 6 | | \$262 |
| | | IN20.25WB42W | 20.25" | 42" | 7 | | \$267 |
| | | IN20.25WB48W | 20.25" | 48" | 8 | | \$273 |
| | | IN20.25WB54W | 20.25" | 54" | 9 | | \$276 |
| | | IN20.25WB60W | 20.25" | 60" | 9 | | \$286 |
|  | 23.6" H Wall Mount Whiteboard To be used above Planna cases | IN23.6WMWB24 | 23.6" | 24" | 4 | | \$262 |
| | | IN23.6WMWB30 | 23.6" | 30" | 5 | | \$272 |
| | | IN23.6WMWB36 | 23.6" | 36" | 6 | | \$280 |
| | | IN23.6WMWB42 | 23.6" | 42" | 7 | | \$287 |
| | | IN23.6WMWB48 | 23.6" | 48" | 8 | | \$290 |
|  | 6.75" H Wall Mount Paper Management | IN6.75PM30W | 6.75" | 30" | 5 | \$214 | +\$24 |
| | | IN6.75PM36W | 6.75" | 36" | 6.5 | \$231 | +\$25 |
| | | IN6.75PM42W | 6.75" | 42" | 8.5 | \$254 | +\$27 |
| | | IN6.75PM48W | 6.75" | 48" | 9 | \$273 | +\$30 |
| | | IN6.75PM54W | 6.75" | 54" | 11 | \$291 | +\$31 |
| | | IN6.75PM60W | 6.75" | 60" | 12.5 | \$310 | +\$33 |
|  | 20.25" H Wall Mount Paper Management | IN20.25PM24W | 20.25" | 24" | 12 | \$506 | +\$53 |
| | | IN20.25PM30W | 20.25" | 30" | 15 | \$667 | +\$69 |
| | | IN20.25PM36W | 20.25" | 36" | 18 | \$696 | +\$71 |
| | | IN20.25PM42W | 20.25" | 42" | 21 | \$755 | +\$77 |
| | | IN20.25PM48W | 20.25" | 48" | 24 | \$814 | +\$85 |

- Wall mounted accessories may be specified to mount to any drywall application
- Additional wall bracing should be taken into consideration when ordering any wall hung component which will carry additional weight
- Ensure wall in adequately constructed and/or braced to ensure a secure installation
- All wall mount brackets are included

NOTES

- See finishes section for fabrics that require scrim

| | Part number | W | Wt (lbs) | Grade 1/ COM/ base price | Grade 2 | Grade 3 | Grade 4 | Grade 5 | Grade 6 | Grade 7 | Grade 8 | Scrim |
|---|--------------------|-----|----------|--------------------------------|---------|---------|---------|---------|---------|---------|---------|-------|
|  | IN13.5TB18W | 18" | 2 | \$253 | +\$9 | +\$15 | +\$22 | +\$29 | +\$46 | +\$61 | +\$46 | +\$24 |
| | IN13.5TB24W | 24" | 3 | \$262 | +\$7 | +\$12 | +\$20 | +\$26 | +\$45 | +\$60 | +\$45 | +\$26 |
| | IN13.5TB30W | 30" | 3 | \$286 | +\$8 | +\$12 | +\$20 | +\$26 | +\$45 | +\$61 | +\$45 | +\$27 |
| | IN13.5TB36W | 36" | 4 | \$291 | +\$12 | +\$26 | +\$35 | +\$45 | +\$67 | +\$92 | +\$67 | +\$29 |
| | IN13.5TB42W | 42" | 4 | \$301 | +\$11 | +\$27 | +\$36 | +\$47 | +\$72 | +\$98 | +\$72 | +\$31 |
| | IN13.5TB48W | 48" | 5 | \$309 | +\$15 | +\$27 | +\$36 | +\$47 | +\$72 | +\$99 | +\$72 | +\$32 |

13.5" H Wall Mount Tackboard

| | | | | | | | | | | | | |
|---|---------------------|-----|---|-------|-------|-------|-------|-------|-------|--------|--------|-------|
|  | IN20.25TB18W | 18" | 3 | \$290 | +\$7 | +\$13 | +\$23 | +\$33 | +\$54 | +\$76 | +\$105 | +\$26 |
| | IN20.25TB24W | 24" | 4 | \$314 | +\$8 | +\$20 | +\$29 | +\$37 | +\$61 | +\$86 | +\$118 | +\$29 |
| | IN20.25TB30W | 30" | 5 | \$323 | +\$7 | +\$21 | +\$30 | +\$39 | +\$63 | +\$88 | +\$120 | +\$31 |
| | IN20.25TB36W | 36" | 6 | \$330 | +\$10 | +\$22 | +\$33 | +\$45 | +\$71 | +\$99 | +\$137 | +\$33 |
| | IN20.25TB42W | 42" | 7 | \$341 | +\$9 | +\$16 | +\$30 | +\$45 | +\$72 | +\$101 | +\$140 | +\$35 |
| | IN20.25TB48W | 48" | 8 | \$348 | +\$11 | +\$29 | +\$42 | +\$52 | +\$86 | +\$115 | +\$161 | +\$37 |



20.25" H Wall Mount Tackboard

| | | | | | | | | | | | | |
|---|---------------------|-----|---|-------|-------|-------|-------|-------|-------|--------|--------|-------|
|  | IN23.6WMTK24 | 24" | 4 | \$425 | +\$8 | +\$15 | +\$26 | +\$39 | +\$67 | +\$97 | +\$134 | +\$30 |
| | IN23.6WMTK30 | 30" | 5 | \$439 | +\$7 | +\$16 | +\$29 | +\$44 | +\$73 | +\$104 | +\$144 | +\$32 |
| | IN23.6WMTK36 | 36" | 6 | \$448 | +\$11 | +\$22 | +\$35 | +\$49 | +\$86 | +\$119 | +\$166 | +\$34 |
| | IN23.6WMTK42 | 42" | 7 | \$462 | +\$9 | +\$16 | +\$30 | +\$46 | +\$84 | +\$119 | +\$166 | +\$36 |
| | IN23.6WMTK48 | 48" | 8 | \$471 | +\$12 | +\$26 | +\$42 | +\$54 | +\$94 | +\$133 | +\$185 | +\$39 |

23.6" H Wall Mount Tackboard
To be used above Planna cases

NOTES

- Only Expo Markers are to be used on any Inscape Whiteboard. Whiteboards should be cleaned with Expo Eraser or a Microfiber cleaning cloth along with Expo Cleaning Solution which is formulated to remove residue from Expo Dry Erase Markers

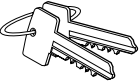
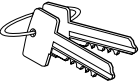
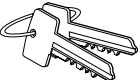
| | | Part number | H | W | Wt (lbs) | List price |
|---|---|--------------------|-------|-----|----------|------------|
|  | 19.5" H Magnetic Whiteboard | WHBDM137195 | 19.5" | 14" | 3 | \$291 |
|  | 33" H Magnetic Whiteboard | WHBDM13733 | 33" | 14" | 5 | \$310 |
|  | Replacement Key Specify key number found on face of lock | RKEY | — | — | — | \$12 |
|  | Master Key Specify key number found on face of lock | MKEY | — | — | — | \$51 |
|  | Extractor Key Specify key number found on face of lock | EKEY | — | — | — | \$51 |

- Overhead Storage sorters are to be ordered for use with overhead bin and shelves only
- No tools required to install components
- The sliding dividers are for use with Overhead Bin only

| | Part number | H | W | Wt (lbs) | Neutral paint/ base price | Accent paint |
|---|-------------|---|---|----------|------------------------------|-----------------|
|  <p>Sliding Divider (qty of 3) Compatible with overhead bins</p> | SDV | — | — | 5 | \$103 | +\$13 |

- The Electrified Twin-Bin accessories are able to mount onto the back of the Electrified Twin-Bin only
- Do not specify these accessories with the standard Twin-Bin as they will interfere with the sliding door
- Electrified Twin-Bin Tackboard available in all grades of fabric
- Electrified Twin-Bin Shelf is only compatible with the Electrified Twin-Bin
- The width of the Electrified Twin-Bin accessories specified should be $\frac{1}{3}$ the overall width of the case (i.e. $36 \div 3 = 12$)

NOTES

- Only Expo Markers are to be used on any Inscape Whiteboard. Whiteboards should be cleaned with Expo Eraser or a Microfiber cleaning cloth along with Expo Cleaning Solution which is formulated to remove residue from Expo Dry Erase Markers

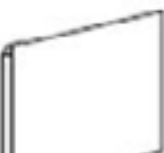
| | Part number | H | W | Wt (lbs) | Neutral paint/ base price | Accent paint |
|--|---------------------------------|-----|-----|----------|------------------------------|-----------------|
|  | Electrified Twin-Bin Shelf | | | | | |
| | INETWBSHF-12 | — | 12" | — | \$105 | +\$13 |
| | INETWBSHF-14 | — | 14" | — | \$105 | +\$13 |
| | INETWBSHF-16 | — | 16" | — | \$105 | +\$13 |
| | INETWBSHF-18 | — | 18" | — | \$105 | +\$13 |
| | INETWBSHF-20 | — | 20" | — | \$105 | +\$13 |
|  | Electrified Twin-Bin Whiteboard | | | | | |
| | INTWBWB-12 | 14" | 12" | — | \$39 | — |
| | INTWBWB-14 | 14" | 14" | — | \$39 | — |
| | INTWBWB-16 | 14" | 16" | — | \$39 | — |
| | INTWBWB-18 | 14" | 18" | — | \$45 | — |
| | INTWBWB-20 | 14" | 20" | — | \$45 | — |

| Part number | H | W | Wt (lbs) | Grade 1/ COM/ base price | Grade 2 | Grade 3 | Grade 4 | Grade 5 | Grade 6 | Grade 7 | Grade 8 |
|-------------------|-----|-----|----------|--------------------------------|---------|---------|---------|---------|---------|---------|---------|
| INTWBTB-12 | 14" | 12" | — | \$130 | +\$8 | +\$16 | — | +\$29 | — | +\$74 | — |
| INTWBTB-14 | 14" | 14" | — | \$133 | +\$8 | +\$16 | — | +\$29 | — | +\$74 | — |
| INTWBTB-16 | 14" | 16" | — | \$139 | +\$8 | +\$16 | — | +\$29 | — | +\$74 | — |
| INTWBTB-18 | 14" | 18" | — | \$145 | +\$8 | +\$16 | — | +\$29 | — | +\$74 | — |
| INTWBTB-20 | 14" | 20" | — | \$159 | +\$8 | +\$16 | — | +\$29 | — | +\$74 | — |



Electrified Twin-Bin Tackboard

- “2F” denotes use with 2 ¾" thick frame
“3F” denotes use with 3 ½" thick frame
- Shared Twin Bin Top span the frame to give one complete finished top (no top trim required to be specified in this location)
- Single Twin Bin and Shared Twin Bin Tops are specified for the top of the Twin Bin
- Two Single Twin Bin Tops are required to finish one Twin Bin as there are two sides (either side of frame)
- Twin Bin tops are shipped complete with ability to mount directly on case
- Nuform Twin Bin Tops are ⅜" thick



NOTES

In order to get a total cost on products when upcharges are present take the list price of the product number and add the upcharge cost shown to the list price.



For example:







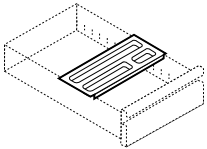
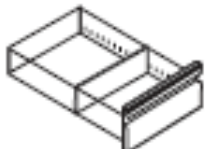
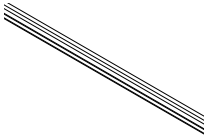
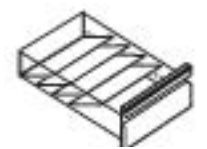
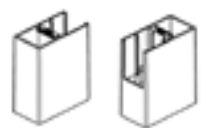

Product INTWBTOP36-3F 0.25" in Nuform Select would be \$279 +\$31

| | | Part number | H | W | Wt (lbs) | Neutral paint/ base price | Accent paint |
|---|---------------------------------|------------------|---|-----|----------|------------------------------|-----------------|
|  | Shared Twin Bin Top, painted | INTWST-30 | — | 30" | — | \$320 | +\$34 |
| | | INTWST-36 | — | 36" | — | \$388 | +\$43 |
| | | INTWST-42 | — | 42" | — | \$403 | +\$44 |
| | | INTWST-48 | — | 48" | — | \$442 | +\$47 |
| | | INTWST-54 | — | 54" | — | \$481 | +\$51 |
| | | INTWST-60 | — | 60" | — | \$518 | +\$54 |

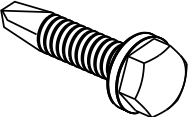

| | | Part number | D | W | Wt (lbs) | Nuform classic/ base price | Nuform select |
|---|---|----------------------|------|-----|----------|----------------------------------|------------------|
|  | Single Twin Bin Top For use with 3 ½" T frames Required 2 per bin | INTWBTOP36-3F | 5" | 36" | 2 | \$279 | +\$31 |
| | | INTWBTOP42-3F | 5" | 42" | 2 | \$289 | +\$32 |
| | | INTWBTOP48-3F | 5" | 48" | 2 | \$318 | +\$34 |
| | | INTWBTOP60-3F | 5" | 60" | 3 | \$371 | +\$34 |
|  | Single Twin Bin Top For use with 2 ¾" T frames Required 2 per bin | INTWBTOP36-2F | 5.4" | 36" | 2 | \$279 | +\$31 |
| | | INTWBTOP42-2F | 5.4" | 42" | 2 | \$289 | +\$32 |
| | | INTWBTOP48-2F | 5.4" | 48" | 2 | \$318 | +\$34 |
| | | INTWBTOP60-2F | 5.4" | 60" | 3 | \$371 | +\$34 |

- Pedestal Extended leveling glide consists of a 1.5" stem

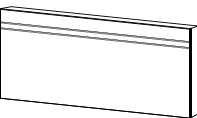
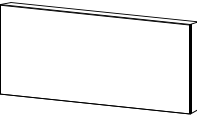
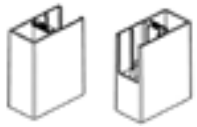

| | | Part number | H | W | Wt (lbs) | List price |
|---|---|------------------|--------|-----|----------|------------|
|  | Pencil tray for letter width box drawer Black plastic | PFWS-PT15 | — | 15" | 1 | \$37 |
| | | Letter Width | | | | |
| | | PFWS-PT18 | — | 18" | 1 | \$37 |
| | | Legal Width | | | | |
|  | Divider for box drawer | PFWS-DV15 | — | 15" | 0.5 | \$22 |
| | | Letter Width | | | | |
| | | PFWS-DV18 | — | 18" | 0.5 | \$22 |
| | | Legal Width | | | | |
|  | Side-to-Side Filing Bar | PFSSF15 | — | 15" | — | \$8 |
| | | Letter Width | | | | |
| | | PFSSF18 | — | 18" | — | \$8 |
| | | Legal Width | | | | |
|  | Set of 4 modular sloped stationery dividers fits box drawer letter width pedestal | PFMD-SO15 | — | 15" | 1 | \$74 |
| | | Letter Width | | | | |
| | | PFMD-SO18 | — | 18" | 1 | \$79 |
| | | Legal Width | | | | |
|  | Rectangular Pedestal Glides, Gray Set of 4 | LV019 | — | — | — | \$46 |
|  | 1.5" stem leveling glides Set of 4 | LG | 3 1/2" | — | 1 | \$29 |

| | | Part number | H | W | Wt (lbs) | Neutral paint/ base price | Accent paint |
|--|--|------------------|--------|---------|----------|------------------------------|-----------------|
|  | Plate divider for 3" and 4.5" shelves/drawers | PFDVP-3 | — | — | 0.5 | \$21 | — |
|  | Plate divider for 6", 7.5" and 9" shelves/drawers | PFDVP6-9 | — | — | 0.75 | \$21 | — |
|  | Plate divider for 10.5", 12", 13.5", 15" and 16.5" drawers or slotted shelves | PFDVP | — | — | 1 | \$21 | — |
|  | Slotted Shelf Fixed slotted shelf installs behind 12", 13.5", 15" and 16.5" lift-up door or in hinged door cabinet. Shelf is adjustable on a 1.5" increment. | PFSH-30 | — | 30" | 11 | \$101 | +\$13 |
| | | PFSH-36 | — | 36" | 12 | \$101 | +\$13 |
| | | PFSH-42 | — | 42" | 13 | \$101 | +\$13 |
|  | Adjustable non-slotted shelf 15" deep | BKSH-3015 | 0.5" | 30" | 11 | \$99 | +\$13 |
| | | BKSH-3615 | 0.5" | 36" | 11 | \$101 | +\$13 |
| | | BKSH-4215 | 0.5" | 42" | 11 | \$103 | +\$13 |
|  | Standard Paper Related Accessories Hangfile bars for 10.5", 12", 13.5", 15" and 16.5" pullout shelves/drawers set of 2 | PFHF-30 | — | 30" | 2 | \$45 | — |
| | | PFHF-36 | — | 36" | 3 | \$45 | — |
| | | PFHF-42 | — | 42" | 4 | \$45 | — |
|  | Sliding rails used in conjunction with HF bars for front-to-back filing, sold individually | PFSR | — | 1.1875" | 1 | \$16 | — |
|  | Ganging Kit | PFGK | — | — | — | \$15 | — |
|  | 18" mobile support frame, for 30" and 36" wide lateral files with maximum of three pullout drawers and maximum interior height of 43.5" Note: Counterweight must be installed in lateral file | PFMFK18 | 4 5/8" | — | 10 | \$540 | — |



- Counterweight recommended for all freestanding lateral file cabinets
- Counterweight secure with 2-way tape
- Lateral Extended leveling glide consists of a 1.5" stem

| | | Part number | H | W | Wt (lbs) | List price |
|---|---|----------------|--------|-----|----------|------------|
|  | 24" mobile support frame, for 24" and 30" wide Workplace Towers with maximum of three pullout drawers and maximum height of 58 3/4" Note: Counterweight is recommended | PFMFK24 | 4 5/8" | 24" | 11 | \$540 |
|  | Counterweight, recommended for all freestanding lateral file cabinets with 22.5" interior dimension or higher | IMCW-30 | — | 30" | 38 | \$144 |
| | | IMCW-36 | — | 36" | 38 | \$144 |
| | | IMCW-42 | — | 42" | 52 | \$144 |
|  | Counterweight, recommended for all freestanding lateral file cabinets with less than 22.5" interior dimension | CW | — | — | 48 | \$144 |
|  | Rectangular Lateral Glides, Gray Set of 4 | LV018 | — | — | — | \$46 |
|  | 1.5" stem leveling glides Set of 4 | LG | 3 1/2" | — | 1 | \$29 |

- Nuform lateral tops are 3/8" thick
- Lateral tops are not available with plywood edge band

| | Part number | W | D | Nuform classic/ laminate/ base price | Nuform select | Grade 1 laminate | |
|---|----------------------------|--------------------|-----|--|------------------|---------------------|--------|
|  | 15" D x 3/8" T Lateral Top | INSWTOP1530 | 30" | 15" | \$204 | +\$17 | +\$66 |
| | | INSWTOP1536 | 36" | 15" | \$219 | +\$32 | +\$71 |
| | | INSWTOP1542 | 42" | 15" | \$248 | +\$35 | +\$81 |
| | | INSWTOP1548 | 48" | 15" | \$276 | +\$43 | +\$90 |
| | | INSWTOP1554 | 54" | 15" | \$303 | +\$48 | +\$99 |
| | | INSWTOP1560 | 60" | 15" | \$374 | +\$106 | +\$121 |
| | | INSWTOP1572 | 72" | 15" | \$405 | +\$127 | +\$131 |
| | | INSWTOP1578 | 78" | 15" | \$441 | +\$115 | +\$142 |
|  | 18" D x 3/8" T Lateral Top | INSWTOP1830 | 30" | 18" | \$221 | +\$15 | +\$72 |
| | | INSWTOP1836 | 36" | 18" | \$238 | +\$35 | +\$77 |
| | | INSWTOP1842 | 42" | 18" | \$267 | +\$45 | +\$88 |
| | | INSWTOP1848 | 48" | 18" | \$295 | +\$52 | +\$97 |
| | | INSWTOP1854 | 54" | 18" | \$328 | +\$53 | +\$106 |
| | | INSWTOP1860 | 60" | 18" | \$507 | +\$56 | +\$165 |
| | | INSWTOP1872 | 72" | 18" | \$605 | +\$63 | +\$196 |
| | | INSWTOP1878 | 78" | 18" | \$704 | +\$73 | +\$227 |

- Includes stand offs to mount on back of case in the field
- Available in White only, colors as special

| | Part number | H | W | Wt (lbs) | List price | |
|---|-----------------------------|------------------|-----|----------|------------|-------|
|  | Lateral Back Painted Glass | PLN30LBPG | 24" | 30" | 16 | \$799 |
| | | PLN36LBPG | 24" | 36" | 19 | \$885 |
| | | PLN42LBPG | 24" | 42" | 22 | \$972 |
|  | Pedestal Back Painted Glass | PLN15LBPG | 24" | 15" | 16 | \$628 |

- 30" W SuperStor™ insert accepts 12 Standard Trays and 3 Small Trays
- 36" W SuperStor™ insert accepts 18 Standard Trays
- 42" W SuperStor™ insert accepts 18 Standard Trays and 3 Small Trays
- Insert and trays may be painted in Inscape System standard color options

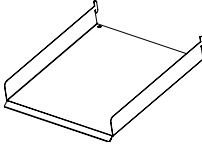
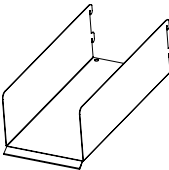
| | | Part number | H | W | Wt (lbs) | Neutral paint/ base paint | Accent paint |
|---|---|----------------------|-------|-----|----------|------------------------------|-----------------|
|  | SuperStor Inserts | INSW13.5SS-30 | 13.5" | 30" | 10 | \$107 | +\$15 |
| | | INSW13.5SS-36 | 13.5" | 36" | 12 | \$127 | +\$16 |
| | | INSW13.5SS-42 | 13.5" | 42" | 14 | \$142 | +\$18 |
|  | Standard SuperStor Trays (pkg. of 6) | SWSSTRAY | — | — | 6 | \$245 | +\$26 |
|  | Small SuperStor Trays (pkg. of 3) | SWSSTRAY-SM | — | — | 3 | \$127 | +\$16 |

- The Classic Cushion is 1 ¼" thick CAL 117 compliant polyurethane foam with a 2.3 lb/ft. density. This upholstered cushion is balanced with a 7/16" board and is attached to the pedestal top with heavy duty Velcro.
- The Lite Cushion is ¾" thick CAL 117 compliant polyurethane foam with a 2.3 lb/ft. density. This upholstered cushion is balanced with a ¼" board and is attached to the pedestal top with Velcro.
- Cushions may be installed on any storage case
- If optioning a cushion on a Planna case, remove Planna rail
- For application of ALL fabrics, both from our graded program as well as COM (customers own material), please specify layup orientation at time of order. If layup instructions are not provided we will choose the direction to maximize our production.

- Refer to the Finishes Section for additional layout and COM details

NOTES

In order to get a total cost on products when upcharges are present take the list price of the product number and add the upcharge cost shown to the list price.

For example:

Product CSH15X18X125 in Grade C fabric would be \$275 +\$103

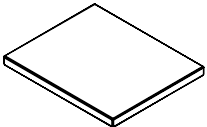
| | Part number | H | W | D | Wt (lbs) | Grade A/ base price | Grade B/ COM | Grade C | Grade D | Grade E | Grade F |
|---|-----------------------|----|-----|-------|----------|------------------------|-----------------|---------|---------|---------|---------|
|  | CSH15X188X075L | ¾" | 15" | 18 ¾" | 5 | \$162 | — | — | — | — | — |
| | CSH15X228X075L | ¾" | 15" | 22 ¾" | 6 | \$169 | — | — | — | — | — |
| | CSH15X288X075L | ¾" | 15" | 28 ¾" | 12 | \$179 | — | — | — | — | — |

15"w Lite Pedestal
Cushion
(9900 Series)

| | | | | | | | | | | | |
|---|---------------------|------|-----|-----|----|-------|-------|--------|--------|--------|--------|
|  | CSH15X18X125 | 1 ¼" | 15" | 18" | 5 | \$275 | +\$57 | +\$103 | +\$145 | +\$174 | +\$249 |
| | CSH15X22X125 | 1 ¼" | 15" | 22" | 6 | \$281 | +\$57 | +\$103 | +\$145 | +\$174 | +\$249 |
| | CSH15X28X125 | 1 ¼" | 15" | 28" | 13 | \$291 | +\$57 | +\$103 | +\$145 | +\$174 | +\$249 |

15"W Classic
Pedestal Cushion
(Planna, Storage
with Handles, Grid
pedestals)

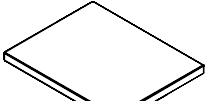
| | | | | | | | | | | | |
|---|------------------------|------|-----|-------|----|-------|-------|--------|--------|--------|--------|
|  | CSH15X18.75X125 | 1 ¼" | 15" | 18 ¾" | 8 | \$276 | +\$57 | +\$103 | +\$145 | +\$174 | +\$249 |
| | CSH15X22.75X125 | 1 ¼" | 15" | 22 ¾" | 9 | \$282 | +\$57 | +\$103 | +\$145 | +\$174 | +\$249 |
| | CSH15X28.75X125 | 1 ¼" | 15" | 28 ¾" | 13 | \$292 | +\$57 | +\$103 | +\$145 | +\$174 | +\$249 |

15"w Classic
Pedestal Cushion
(9900 Series)

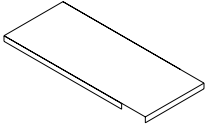
| | | | | | | | | | | | |
|---|---------------------|------|-----|-----|----|-------|-------|--------|--------|--------|--------|
|  | CSH15X36X125 | 1 ¼" | 15" | 36" | 15 | \$315 | +\$57 | +\$103 | +\$145 | +\$174 | +\$249 |
|---|---------------------|------|-----|-----|----|-------|-------|--------|--------|--------|--------|

36" d Classic
Pedestal Cushion
(for back to back
Planna, Storage
with Handles, Grid
pedestal application)

- The Classic Cushion is 1 ¼" thick CAL 117 compliant polyurethane foam with a 2.3 lb/ft. density. This upholstered cushion is balanced with a 7/16" board and is attached to the pedestal top with heavy duty Velcro.
- Cushions may be installed on any storage case
- If optioning a cushion on a Planna case, remove Planna rail
- For application of ALL fabrics, both from our graded program as well as COM (customers own material), please specify layup orientation at time of order. If layup instructions are not provided we will choose the direction to maximize our production.





- Refer to the Finishes Section for additional layout and COM details

NOTES





In order to get a total cost on products when upcharges are present take the list price of the product number and add the upcharge cost shown to the list price.

For example:

Product LATCUSH1830SL in Grade C fabric would be \$425 +\$165

| | Part number | H | W | D | Wt (lbs) | Grade A/ base price | Grade B/ COM | Grade C | Grade D | Grade E | Grade F |
|---|----------------|------|-------|-------|----------|------------------------|-----------------|---------|---------|---------|---------|
|  18" d Classic Lateral Cushion (standard application) | LATCUSH1830SL | 1 ¼" | 30" | 18" | 7 | \$425 | +\$84 | +\$165 | +\$199 | +\$247 | +\$363 |
| | LATCUSH1836SL | 1 ¼" | 36" | 18" | 8 | \$462 | +\$97 | +\$192 | +\$233 | +\$287 | +\$425 |
| | LATCUSH1842SL | 1 ¼" | 42" | 18" | 10 | \$501 | +\$110 | +\$214 | +\$267 | +\$329 | +\$485 |
| | LATCUSH1860SL | 1 ¼" | 60" | 18" | 14 | \$605 | +\$151 | +\$296 | +\$366 | +\$451 | +\$664 |
| | LATCUSH1866SL | 1 ¼" | 66" | 18" | 15 | \$658 | +\$177 | +\$327 | +\$402 | +\$495 | +\$728 |
| | LATCUSH1872SL | 1 ¼" | 72" | 18" | 15 | \$713 | +\$179 | +\$354 | +\$436 | +\$534 | +\$788 |
| | LATCUSH1878SL | 1 ¼" | 78" | 18" | 17 | \$884 | +\$208 | +\$408 | +\$505 | +\$619 | +\$909 |
| LATCUSH1884SL | 1 ¼" | 84" | 18" | 24 | \$832 | +\$237 | +\$437 | +\$584 | +\$704 | +\$1005 | |
|  19 ¾" d Classic Lateral Cushion (Benching application with electrical) | LATCUSH19830SL | 1 ¼" | 30" | 19 ¾" | 7 | \$435 | +\$84 | +\$164 | +\$199 | +\$246 | +\$362 |
| | LATCUSH19836SL | 1 ¼" | 36" | 19 ¾" | 8 | \$476 | +\$96 | +\$191 | +\$231 | +\$286 | +\$424 |
| | LATCUSH19842SL | 1 ¼" | 42" | 19 ¾" | 10 | \$516 | +\$108 | +\$216 | +\$266 | +\$328 | +\$596 |
| | LATCUSH19860SL | 1 ¼" | 60" | 19 ¾" | 14 | \$641 | +\$151 | +\$299 | +\$367 | +\$452 | +\$665 |
| | LATCUSH19866SL | 1 ¼" | 66" | 19 ¾" | 15 | \$682 | +\$166 | +\$326 | +\$400 | +\$494 | +\$725 |
| | LATCUSH19872SL | 1 ¼" | 72" | 19 ¾" | 15 | \$722 | +\$144 | +\$353 | +\$435 | +\$534 | +\$787 |
| | LATCUSH19878SL | 1 ¼" | 78" | 19 ¾" | 17 | \$764 | +\$135 | +\$380 | +\$467 | +\$576 | +\$846 |
| LATCUSH19884SL | 1 ¼" | 84" | 19 ¾" | 24 | \$806 | +\$207 | +\$407 | +\$503 | +\$617 | +\$907 | |
|  21 ½" d Classic Lateral Cushion (Private Office application with electrical) | LATCUSH21530SL | 1 ¼" | 30" | 21 ½" | 7 | \$435 | +\$89 | +\$170 | +\$205 | +\$251 | +\$368 |
| | LATCUSH21536SL | 1 ¼" | 36" | 21 ½" | 8 | \$482 | +\$96 | +\$191 | +\$231 | +\$286 | +\$424 |
| | LATCUSH21542SL | 1 ¼" | 42" | 21 ½" | 11 | \$518 | +\$108 | +\$216 | +\$265 | +\$328 | +\$484 |
| | LATCUSH21560SL | 1 ¼" | 60" | 21 ½" | 15 | \$659 | +\$151 | +\$296 | +\$366 | +\$451 | +\$664 |
| | LATCUSH21566SL | 1 ¼" | 66" | 21 ½" | 16 | \$701 | +\$165 | +\$326 | +\$399 | +\$492 | +\$724 |
| | LATCUSH21572SL | 1 ¼" | 72" | 21 ½" | 17 | \$746 | +\$178 | +\$353 | +\$434 | +\$532 | +\$786 |
| | LATCUSH21578SL | 1 ¼" | 78" | 21 ½" | 18 | \$759 | +\$383 | +\$383 | +\$547 | +\$658 | +\$939 |
| LATCUSH21584SL | 1 ¼" | 84" | 21 ½" | 19 | \$793 | +\$237 | +\$437 | +\$584 | +\$704 | +\$1005 | |
|  36" d Classic Lateral Cushion (back-to-back application) | LATCUSH3630SL | 1 ¼" | 30" | 36" | 14 | \$524 | +\$79 | +\$161 | +\$192 | +\$239 | +\$356 |
| | LATCUSH3636SL | 1 ¼" | 36" | 36" | 19 | \$577 | +\$92 | +\$187 | +\$223 | +\$279 | +\$415 |
| | LATCUSH3642SL | 1 ¼" | 42" | 36" | 19 | \$609 | +\$105 | +\$213 | +\$259 | +\$321 | +\$476 |
|  39 ½" d Classic Lateral Cushion (Back-to-back benching application with electrical) | LATCUSH39530SL | 1 ¼" | 30" | 39 ½" | 14 | \$532 | +\$79 | +\$160 | +\$191 | +\$238 | +\$355 |
| | LATCUSH39536SL | 1 ¼" | 36" | 39 ½" | 19 | \$580 | +\$134 | +\$212 | +\$251 | +\$306 | +\$445 |
| | LATCUSH39542SL | 1 ¼" | 42" | 39 ½" | 19 | \$660 | +\$105 | +\$213 | +\$267 | +\$319 | +\$475 |

- Planna Storage Support Brackets are shipped as a pair and are both required per Planna Storage worksurface installation
- Hat Channel heights are nominal and they support a standard worksurface height of 28.5"
- Planna Storage rail kits are optional on Planna Storage cases, DO NOT specify if a cushion is to be installed
- Lateral kits install with the rail running the width of the case (side to side)
- Pedestal kits install with the rail running the depth of the case (front to back) EXCEPT for the 18" D which runs side to side
- Planna Storage rails are only available in silver (match to P290 Aluminum Leaf)
- Planna Storage Rail kits include mounting hardware to adhere to the case if ordered separate from Planna Storage case

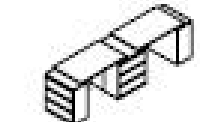
| | Part number | W | D | Wt (lbs) | Neutral paint/ base price | Accent paint |
|--|-----------------------|--------|-----|----------|------------------------------|-----------------|
|  <p>Planna Bracket (pair) Adjustable Height</p> | PSUPBKT | — | — | 1 | \$92 | +\$12 |
|  <p>9" W x 2.89"H Hat Channel For use over Planna case with ½" top with no rail</p> | HATCHNL2.89 | 2.89" | 2 | — | \$52 | +\$9 |
|  <p>9" W x 2.375"H Hat Channel For use over Planna case with ½" top and ½" rail</p> | HATCHNL2.3759 | 2.375" | 2 | — | \$52 | +\$9 |
|  <p>Lateral Rail Kit (rails run case width)</p> | PLANNA-KIT30 | 30" | 18" | 5 | \$161 | — |
| | PLANNA-KIT36 | 36" | 18" | 6 | \$166 | — |
| | PLANNA-KIT42 | 42" | 18" | 6 | \$171 | — |
|  <p>Pedestal Rail Kit (rails run case depth)</p> | PLANNA-KIT1518 | 15" | 15" | 3 | \$156 | — |
| | PLANNA-KIT1522 | 15" | 22" | 4 | \$161 | — |
| | PLANNA-KIT1528 | 15" | 28" | 5 | \$166 | — |
|  <p>Rail Kit for collaborative Area (rails run depth of back-to- back cases)</p> | PLANNA-KIT3615 | 36" | 15" | 5 | \$188 | — |
| | PLANNA-KIT3621 | 36" | 21" | 5 | \$208 | — |

Accessories

Planna Storage
Pedestals and Lateral Tops

System



- Planna Storage tops are ½" thick to withstand weight that may be placed on the Planna Storage case
- Various depths and widths have been created for multiple configurations. Refer to drawing in left column for details
- Planna Storage tops are shipped with double sided tape to adhere on the Planna Storage rails

NOTES

In order to get a total cost on products when upcharges are present take the list price of the product number and add the upcharge cost shown to the list price.

For example:

Product PLN1518 in Nuform Select would be \$86 +\$17

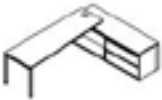
| | Part number | W | D | Wt (lbs) | Nuform classic/ base price | Nuform select |
|---|--------------------------|-------|-------|----------|-------------------------------|------------------|
|  | Pedestal Top | | | | | |
| | PLN1518 | 15" | 18" | 4 | \$86 | +\$17 |
| | PLN1522 | 15" | 22" | 5 | \$111 | +\$17 |
| | PLN1528 | 15" | 28" | 6 | \$138 | +\$17 |
|  | Single Depth Lateral Top | | | | | |
| | PLN1830 | 30" | 18" | 7 | \$146 | +\$20 |
| | PLN1836 | 36" | 18" | 8 | \$170 | +\$22 |
| | PLN1842 | 42" | 18" | 10 | \$194 | +\$23 |
| | PLN1845 | 45" | 18" | 11 | \$210 | +\$26 |
| | PLN1851 | 51" | 18" | 12 | \$225 | +\$29 |
| | PLN1857 | 57" | 18" | 13 | \$245 | +\$31 |
| | PLN1860 | 60" | 18" | 14 | \$258 | +\$32 |
| | PLN1866 | 66" | 18" | 16 | \$282 | +\$32 |
| | PLN1872 | 72" | 18" | 17 | \$304 | +\$36 |
| | PLN1878 | 78" | 18" | 18 | \$327 | +\$37 |
| | PLN1884 | 84" | 18" | 20 | \$348 | +\$45 |
| PLN1890 | 90" | 18" | 21 | \$373 | +\$43 | |
| PLN1896 | 96" | 18" | 23 | \$389 | +\$50 | |
|  | 21 ½" D Lateral Top | | | | | |
| | PLNP2130 | 30" | 21 ½" | 7 | \$165 | +\$21 |
| | PLNP2136 | 36" | 21 ½" | 8 | \$187 | +\$23 |
| | PLNP2142 | 42" | 21 ½" | 11 | \$212 | +\$25 |
| | PLNP2145 | 45" | 21 ½" | 11 | \$228 | +\$27 |
| | PLNP2151 | 51" | 21 ½" | 13 | \$249 | +\$30 |
| | PLNP2157 | 57" | 21 ½" | 15 | \$265 | +\$32 |
| | PLNP2160 | 60" | 21 ½" | 15 | \$285 | +\$34 |
| | PLNP2166 | 66" | 21 ½" | 16 | \$312 | +\$37 |
| | PLNP2172 | 72" | 21 ½" | 18 | \$333 | +\$51 |
| | PLNP2178 | 78" | 21 ½" | 19 | \$358 | +\$42 |
| | PLNP2184 | 84" | 21 ½" | 21 | \$381 | +\$48 |
| PLNP2190 | 90" | 21 ½" | 23 | \$408 | +\$61 | |
| PLNP2196 | 96" | 21 ½" | 24 | \$448 | +\$67 | |

Accessories

Planna Storage
Pedestals and Lateral Tops

System

- Planna Storage tops are ½" thick to withstand weight that may be placed on the Planna Storage case
- Various depths and widths have been created for multiple configurations. Refer to drawing in left column for details
- Planna Storage tops are shipped with double sided tape to adhere on the Planna Storage rails

NOTES

In order to get a total cost on products when upcharges are present take the list price of the product number and add the upcharge cost shown to the list price.

For example:

Product PLN3630 in Nuform Select would be \$250 +\$39

| | Part number | W | D | Wt (lbs) | Nuform classic/ base price | Nuform select | |
|---|--------------------|----------------|-----|----------|-------------------------------|---------------|--------|
|  | Back to Back Depth | PLN3630 | 30" | 36" | 14 | \$250 | +\$39 |
| | Lateral Top | PLN3636 | 36" | 36" | 17 | \$285 | +\$48 |
| | | PLN3642 | 42" | 36" | 20 | \$320 | +\$54 |
| | | PLN3645 | 45" | 36" | 22 | \$351 | +\$59 |
| | | PLN3651 | 51" | 36" | 25 | \$376 | +\$64 |
| | | PLN3657 | 57" | 36" | 27 | \$401 | +\$70 |
| | | PLN3660 | 60" | 36" | 28 | \$427 | +\$76 |
| | | PLN3666 | 66" | 36" | 31 | \$449 | +\$76 |
| | | PLN3672 | 72" | 36" | 34 | \$495 | +\$92 |
| | | PLN3678 | 78" | 36" | 37 | \$519 | +\$91 |
| | | PLN3684 | 84" | 36" | 39 | \$566 | +\$105 |
| | | PLN3690 | 90" | 36" | 42 | \$591 | +\$105 |
| | PLN3696 | 96" | 36" | 45 | \$637 | +\$121 | |

Accessories

Planna Storage

Tops to Accommodate Benching Electrical

System





- Planna Storage tops are ½" thick to withstand weight that may be placed on the Planna Storage case
- Various depths and widths have been created for multiple configurations. Refer to drawing in left column for details
- Planna Storage tops are shipped with double sided tape to adhere on the Planna Storage rails

NOTES

In order to get a total cost on products when upcharges are present take the list price of the product number and add the upcharge cost shown to the list price.

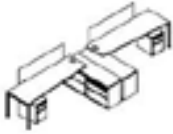
For example:

Product PLNB1930 in Nuform Select would be \$146 +\$20

| | | Part number | H | W | Wt (lbs) | Nuform classic/ base price | Nuform select |
|---|---|-----------------|-------|-------|----------|-------------------------------|------------------|
|  | Single Depth Lateral Top with 1 ¾" D Overhang | PLNB1930 | 30" | 19 ¾" | 6 | \$146 | +\$20 |
| | | PLNB1936 | 36" | 19 ¾" | 7 | \$170 | +\$22 |
| | | PLNB1942 | 42" | 19 ¾" | 8 | \$194 | +\$23 |
| | | PLNB1945 | 45" | 19 ¾" | 9 | \$212 | +\$25 |
| | | PLNB1951 | 51" | 19 ¾" | 10 | \$229 | +\$26 |
| | | PLNB1957 | 57" | 19 ¾" | 11 | \$251 | +\$27 |
| | | PLNB1960 | 60" | 19 ¾" | 11 | \$258 | +\$32 |
| | | PLNB1972 | 72" | 19 ¾" | 14 | \$304 | +\$36 |
| | | PLNB1984 | 84" | 19 ¾" | 14 | \$348 | +\$45 |
|  | Double Depth Back to Back with 3 ½" Additional Depth | PLNB3930 | 30" | 39 ½" | 12 | \$250 | +\$39 |
| | | PLNB3936 | 36" | 39 ½" | 14 | \$285 | +\$48 |
| | | PLNB3942 | 42" | 39 ½" | 16 | \$320 | +\$54 |
| | | PLNB3945 | 45" | 39 ½" | 17 | \$351 | +\$59 |
| | | PLNB3951 | 51" | 39 ½" | 20 | \$386 | +\$64 |
| | | PLNB3957 | 57" | 39 ½" | 22 | \$427 | +\$76 |
|  | Single Depth Lateral Top with 1 ¾" Additional Overhang ½" thick | PLNB1831 | 31 ¾" | 18" | 6 | \$146 | +\$20 |
| | | PLNB1837 | 37 ¾" | 18" | 7 | \$170 | +\$22 |
| | | PLNB1843 | 43 ¾" | 18" | 8 | \$194 | +\$23 |
| | | PLNB1846 | 46 ¾" | 18" | 8 | \$212 | +\$25 |
| | | PLNB1852 | 52 ¾" | 18" | 9 | \$229 | +\$26 |
| | | PLNB1858 | 58 ¾" | 18" | 9 | \$251 | +\$27 |
| | | PLNB1861 | 61 ¾" | 18" | 11 | \$258 | +\$32 |
| | | PLNB1873 | 73 ¾" | 18" | 13 | \$304 | +\$36 |
| | | PLNB1885 | 85 ¾" | 18" | 15 | \$348 | +\$45 |
|  | Double Depth Lateral Top with 1 ¾" Length Overhang | PLNB3631 | 31 ¾" | 36" | 11 | \$250 | +\$39 |
| | | PLNB3637 | 37 ¾" | 36" | 13 | \$285 | +\$48 |
| | | PLNB3643 | 43 ¾" | 36" | 15 | \$320 | +\$54 |
| | | PLNB3646 | 46 ¾" | 36" | 16 | \$351 | +\$59 |
| | | PLNB3652 | 52 ¾" | 36" | 18 | \$375 | +\$59 |
| | | PLNB3658 | 58 ¾" | 36" | 20 | \$391 | +\$59 |
| | | PLNB3661 | 61 ¾" | 36" | 22 | \$427 | +\$76 |
| | | PLNB3667 | 67 ¾" | 36" | 24 | \$449 | +\$76 |
| | | PLNB3673 | 73 ¾" | 36" | 26 | \$495 | +\$92 |
| | | PLNB3679 | 79 ¾" | 36" | 28 | \$519 | +\$91 |
| | | PLNB3685 | 85 ¾" | 36" | 30 | \$566 | +\$105 |
| | | PLNB3691 | 91 ¾" | 36" | 32 | \$591 | +\$105 |
| | | PLNB3697 | 97 ¾" | 36" | 34 | \$637 | +\$121 |

Bench US Price List

June 2021

inscape

work for tomorrow

Bench Architecture

inscape

work for tomorrow

INSCAPE BENCH SPINE

Inscape Bench spine frames are constructed of 16 gauge tubular steel uprights with welded 18 gauge steel crossrails. This strong yet lightweight construction provides ease of movement and reconfiguration.

The simplicity of the spine structure provides an intelligent solution to cable management. The absence of baseplates, apertures and corner posts eliminate barriers that restrict the routing of cables. Cabling may be routed both vertically and horizontally through the panel. Cables are laid into cable managers that easily install between panel crossrails throughout the framework. Cable managers safely cradle and segregate cables. An aperture free system means installation and reconfiguration costs are kept to a minimum. Reconfiguration is easy and economical. Cabling simply eases out of the cable managers and is laid back in at the desired point, eliminating the costly need to cut and re-terminate cables for every reconfiguration. *See Inscape Bench Application Guide for quantity of cables achievable in the various spines.

SPINES

Spines do not include the electrical cover kit but may house power which is to be accessed in alternate locations with a "cutout" tile. The spine comes with one wire manager. Electrical and data components must be specified separately.

Spine glides provide 1.5" height adjustment allowing air to circulate. Spines are available in 6" increments in widths ranging from 30" W to 60" W.

MID SPINE SUPPORT LEG

A Mid Spine Support Leg must be specified when the Partial Height Spine or the Filing Spine are specified. This leg is a support between two spine frames. There is also a 120° version available. The legs are specific to parallel and 90° applications. The mid spine support legs specific to 90° applications are available in wood, straight metal and T metal styles. The wood style come in Clear Oak (default), Black Oak and Clear Maple finishes. The metal styles are painted and come in all standard options.

END SPINE SUPPORT LEG

An End Spine Support Leg must be specified at the very end of a Partial Height Spine frame run. This leg is specific to 90° applications. It is available in wood, straight metal and T metal styles. The wood style come in Clear Oak (default), Black Oak and Clear Maple finishes. The metal styles are painted and come in all standard options.

90° SPINE SUPPORT LEG

A 90° Spine Support Leg must be specified at the connection point when two Partial Height Benching spine frames are connected at a 90° angle. This leg is specific to 90° applications. It is available in wood and straight metal. The wood style come in Clear Oak (default), Black Oak and Clear Maple finishes. The metal styles are painted and come in all standard options.

STACK-ON FRAME

The Stack-on Frame consists of a 6.75", 10.125", 13.5", 20.25" and 27" frame which may be installed on any Inscape Bench spine of the same width or combination of two frames as outlined in the Inscape Bench Application Guide only. The Stack-on frame is load bearing and can be stacked one high above spine frame. Tiles and trim are specified separately. Stack-on frames are frame thickness specific and should be specified accordingly.

DOUBLE GLAZED STACK-ON KIT

Double Glazed Stack-On Kit is a stack-on with a double glazed insert. The 30" to 48" W Double Glazed Stack-on is a fully welded frame stack-on. Double Glazed Stacks which are 54" and wider are kitted and are installed on site. The Double Glazed Stack-on is not load bearing and no stacks can be stacked on top of the Double Glaze. Finishes are available in Clear or Frosted Acrylic to match Double Glazed tile.

TRIM & CONNECTORS

All Top Caps, End of Line Trim, and Connectors must be specified independently from the frame.

INLINE CONNECTORS

Inline Connectors are specified to join two units together which are in alignment. These connectors are specified based as INLINE-2 which will connect any of the Inscape Bench spines as well as the stack-ons. Be sure to specify inline connectors for the Stack-ons and Double Glaze Kits separately.

CONNECTOR TRIM KITS

Connectors are specified independently from the inline connectors and include all necessary brackets and trim for the condition. They are available in two styles; 90° and 120°.

90° corner connectors are used in 90° applications only.

120° connectors are available in "Y" connectors are for 3-way connections and "V" connectors are for 2-way connections.

TOP CAPS

Top Caps are specified separately. The Top Cap includes clips to mount on spine or Stack-on in addition to the option of spanning two frames as outlined in the Inscape Bench Application Guide.

END TRIM

End Trim is kit structured to include all brackets, bolts and finished trim; Flat profile. Trim is manufactured from aluminum and always aligns straight and true at end of the Filing spine. All painted aluminum vertical trim and top trim are easily removed to facilitate lay in of cables.

STACK-ON END TRIM

Stack-on End Trim is used when a higher Stack-on requires vertical end trim at a connection. Hi-Lo trim may be used in this application for Flat profile trim because there is no 'scribing' that is required for this profile.

TILES

Tiles are available as Fabric, Painted, Tackable, Nuform, Double Glazed, Paper Management and Whiteboard. 13.5" H tiles are interchangeable between Inscape System and Inscape Bench. Tile heights vary and must always align with the spine they are to be installed on.

ie. 23.6" H tiles = Full Height Spine, 10.125" H tiles = Stack-on, 13.5" H tiles = Partial Height and Storage Spine. Tile clips support spine tiles and top trim.

FABRIC AND PAINTED TILES

Fabric and Painted Tiles are available 23.6", 10.125" and 13.5" H and are constructed of 24 gauge galvanized steel. Powder-coated and fabric-covered steel tiles have a flame spread rating of less than 200 when tested according to ASTM-E84. Fabric-covered tiles are available in standard fabrics or COM. COM fabrics are subject to approval. White or extremely light colored COM fabrics will incur an upcharge of 25% to the tile pricing with which the fabric is being applied. This is due to special handling of the fabric and tiles, in addition to painting of the tiles. Painted tiles are available in the colors shown in our Color Guide and are available in the following styles: plain steel, embossed, perforated, and steel screen. Fabric on tiles is applied in a railroad orientation.

TACKABLE TILES

Tackable Tiles are constructed from 24 gauge cold rolled steel with a paint finish on all surfaces to prevent corrosion. The same general rules from the fabric tile section apply to the Tackable tiles. Fabric on tiles is applied in a railroad orientation. NRC 0.57, STC 9. Tackable Acoustical tiles are available through Standard Specials with and NRC .73 and an STC of 12.

NUFORM TILES

Nuform Tiles consist of white melamine-backed MDF substrate 0.375" thick, with vacuum-formed Nuform foil over the front's surface and sides. The back-side of the tile also has routing features that accept zinc die-cast tile clips. All Nuform tiles incorporate a stiffener on the rear of the tile to ensure straightness and rigidity. This stiffener limits where the tile may be placed on the Inscape Bench spine. Nuform tiles cannot be specified in a location where a power track is installed due to interference. A sticker on the back of Nuform tiles provides UL flame/smoke-rating information. Woodgrain pattern is vertical. Due to limitations in the foil size, 48" and wider tiles are not available in F06 Walnut.

WHITEBOARD TILES

Whiteboard Tiles are available in heights of 13.5". Tiles are constructed from 24 gauge cold rolled steel with a white paint finish that has been specifically formulated for dry erase markers. Whiteboards are seamless and fit same locations as standard painted tiles.

NOTE: Only Expo Markers are to be used on any Inscape Whiteboard. Whiteboards should be cleaned with Expo Eraser or a Microfiber cleaning cloth along with Expo Cleaning Solution which is formulated to remove residue from Expo Dry Erase Markers.

PAPER MANAGEMENT TILES

Paper Management Tiles support horizontal paper management accessories. Organizers may be positioned at any point along the width of the tile. Three slats structured into the tile allow for three different height options for the accessories to be installed. Accessories may be found under Horizontal Accessories under the "Storage and Accessories" section. Maximum load capacity is 75lbs. When specifying paper management tiles which will be supporting a monitor arm, a Paper Management Reinforcing kit is required for additional structure. The 54" and 60" W tiles are pre-structured with these kits.

PERFORATED AND EMBOSSED TILES

Perforated and Embossed Tiles are constructed of 24 gauge galvanized steel, the Steel Screen Tiles are constructed from 24 gauge cold rolled steel. Tiles may be painted in any of Inscape's standard colors or color matches.

COMMUNICATION TILES

Communication Tiles provide power OR data access. The 30" W includes one cutout while all wider tile widths include two cutouts. Bezels in tile may be specified in black, white (close match to P168 – Glacier White) and gray (close match to P290 – Aluminum Leaf) as well with the data or electrical components. Bezels are flush with tile, NOT recessed.

MULTI-ACCESS TILES

Multi-access Tiles provide electrical AND data access. Cutouts align with power track and proper tiles must be specified in specific areas if stated. Data and Electrical components may be specified from the Technology section. Bezels in tile may be specified in black, white (close match to P168 – Glacier White) and gray (close match to P290 – Aluminum Leaf) as well with the data or electrical components. Bezels are flush with tile, NOT recessed.



COMMUNICATION AND MULTI-ACCESS TILES WITH SINGLE SIDED CUTOUTS

Communication and multi-access tiles with single sided cutouts have one cutout per tile (or two above each other for multi-access) and the cutouts are left or right justified making the tiles handed. They are intended to be specified so that the cutouts are hidden below the worksurface. Use one left and one right hand collaborative communication tile for each Bench Collaborative area

DOUBLE GLAZED TILES

Double Glazed Tiles are available in 13.5" H and may be installed on frames 24" to 48" W in place of a tile. Double Glazed tiles feature a double pane of frosted acrylic or clear acrylic framed by vertical and horizontal trim. Double Glazed tiles may be installed one on top of another. If wider than 60" of glaze is desired; Stack on Double Glazed kits may be specified.





- 2 ¾" thick spine when clad with tiles
- Power Track Kit (Upper Deck) only - no electrical clips included
- Includes one cable hook
- Bench spine frames come standard with rectangular glides. Black and gray options available

| | Part number | H | W | Thickness | List price |
|---|---------------------------------|-------|-----|-----------|------------|
|  | Full Height Benching Spine | | | | |
| | INBFHF2730 | 27" | 30" | 2 ¾" | \$205 |
| | INBFHF2736 | 27" | 36" | 2 ¾" | \$210 |
| | INBFHF2742 | 27" | 42" | 2 ¾" | \$213 |
| | INBFHF2748 | 27" | 48" | 2 ¾" | \$216 |
| | INBFHF2754 | 27" | 54" | 2 ¾" | \$220 |
| | INBFHF2760 | 27" | 60" | 2 ¾" | \$254 |
|  | Partial Height Benching Spine | | | | |
| | INBPHF13.530 | 13.5" | 30" | 2 ¾" | \$167 |
| | INBPHF13.536 | 13.5" | 36" | 2 ¾" | \$171 |
| | INBPHF13.542 | 13.5" | 42" | 2 ¾" | \$175 |
| | INBPHF13.548 | 13.5" | 48" | 2 ¾" | \$179 |
| | INBPHF13.554 | 13.5" | 54" | 2 ¾" | \$185 |
| | INBPHF13.560 | 13.5" | 60" | 2 ¾" | \$216 |
|  | Storage Anchored Benching Spine | | | | |
| | INBFF30 | 13.5" | 30" | 2 ¾" | \$183 |
| | INBFF36 | 13.5" | 36" | 2 ¾" | \$187 |
| | INBFF42 | 13.5" | 42" | 2 ¾" | \$192 |
| | INBFF48 | 13.5" | 48" | 2 ¾" | \$197 |
| | INBFF54 | 13.5" | 54" | 2 ¾" | \$200 |
| | INBFF60 | 13.5" | 60" | 2 ¾" | \$231 |

- 2 3/4" thick when clad with tiles
- No Twin Bin placement on the 13.5"H Stack-on
- 20.25"H requires an additional crossrail (separately) if Twin Bin or 13.5"H tile being specified
- Fully welded stack on kits easily installed and removed to adjust panel height
- Load bearing
- Stack on frames may span multiple frames
- See Application Guide for spanning guidelines

NOTE

With the exception of the 10.125" H stack-on frame, standard Inscape System tiles can be used for Bench Stack-On frames.

| | | Part number | H | W | Thickness | List price |
|---|--|--------------|---------|-----|-----------|------------|
|  | 6.75" H Single Stack-On, 2 3/4" T | INSF030-2F | 6.75" | 30" | 2 3/4" | \$162 |
| | | INSF036-2F | 6.75" | 36" | 2 3/4" | \$166 |
| | | INSF042-2F | 6.75" | 42" | 2 3/4" | \$169 |
| | | INSF048-2F | 6.75" | 48" | 2 3/4" | \$174 |
| | | INSF054-2F | 6.75" | 54" | 2 3/4" | \$175 |
| | | INSF060-2F | 6.75" | 60" | 2 3/4" | \$179 |
|  | 10.125" H Single Stack-On, 2 3/4" T | INSF1030-2F | 10.125" | 30" | 2 3/4" | \$165 |
| | | INSF1036-2F | 10.125" | 36" | 2 3/4" | \$168 |
| | | INSF1042-2F | 10.125" | 42" | 2 3/4" | \$171 |
| | | INSF1048-2F | 10.125" | 48" | 2 3/4" | \$178 |
| | | INSF1054-2F | 10.125" | 54" | 2 3/4" | \$179 |
| | | INSF1060-2F | 10.125" | 60" | 2 3/4" | \$183 |
|  | 13.5" H Single Stack-On, 2 3/4" T | INSF130-2F | 13.5" | 30" | 2 3/4" | \$167 |
| | | INSF136-2F | 13.5" | 36" | 2 3/4" | \$170 |
| | | INSF142-2F | 13.5" | 42" | 2 3/4" | \$174 |
| | | INSF148-2F | 13.5" | 48" | 2 3/4" | \$180 |
| | | INSF154-2F | 13.5" | 54" | 2 3/4" | \$183 |
| | | INSF160-2F | 13.5" | 60" | 2 3/4" | \$184 |
|  | 20.25" H Single Stack-On, 2 3/4" T | INSF2030D-2F | 20.25" | 30" | 2 3/4" | \$178 |
| | | INSF2036D-2F | 20.25" | 36" | 2 3/4" | \$183 |
| | | INSF2042D-2F | 20.25" | 42" | 2 3/4" | \$187 |
| | | INSF2048D-2F | 20.25" | 48" | 2 3/4" | \$191 |
| | | INSF2054D-2F | 20.25" | 54" | 2 3/4" | \$192 |
| | | INSF2060D-2F | 20.25" | 60" | 2 3/4" | \$195 |
|  | 27" H Single Stack-On, 2 3/4" T | INSF230-2F | 27" | 30" | 2 3/4" | \$195 |
| | | INSF236-2F | 27" | 36" | 2 3/4" | \$199 |
| | | INSF242-2F | 27" | 42" | 2 3/4" | \$201 |
| | | INSF248-2F | 27" | 48" | 2 3/4" | \$207 |
| | | INSF254-2F | 27" | 54" | 2 3/4" | \$208 |
| | | INSF260-2F | 27" | 60" | 2 3/4" | \$209 |

- Stack on Double Glaze is non-load bearing
- Stack on Double Glaze may span two frames. See Application Guide for spanning guidelines
- 30" to 48" W kits consist of welded frames
- 54" to 96" W kits are kitted and must be assembled on-site
- Clear and Frosted Acrylic options available
- May be located in the top location only
- Be sure to specify correct thickness of stack-on frame based on the frame it is being installed on

NOTE





In order to get a total cost on products when upcharges are present take the list price of the product number and add the upcharge cost shown to the list price.

For example:

Product INSTGL30-2F in Frosted Acrylic would be \$521 +\$92

| | Part number | H | W | Thickness | Clear acrylic/ neutral paint/ base price | Frosted acrylic | Accent paint |
|--|--------------------|-------|-----|-----------|--|--------------------|-----------------|
|  <p>13.5" H Double Glaze Stack-On Acrylic</p> | INSTGL30-2F | 13.5" | 30" | 2 3/4" | \$521 | +\$92 | +\$54 |
| | INSTGL36-2F | 13.5" | 36" | 2 3/4" | \$596 | +\$103 | +\$61 |
| | INSTGL42-2F | 13.5" | 42" | 2 3/4" | \$645 | +\$114 | +\$66 |
| | INSTGL48-2F | 13.5" | 48" | 2 3/4" | \$714 | +\$126 | +\$73 |
| | INSTGL54-2F | 13.5" | 54" | 2 3/4" | \$783 | +\$124 | +\$83 |
| | INSTGL60-2F | 13.5" | 60" | 2 3/4" | \$862 | +\$135 | +\$89 |
| | INSTGL66-2F | 13.5" | 66" | 2 3/4" | \$916 | +\$160 | +\$94 |
| | INSTGL72-2F | 13.5" | 72" | 2 3/4" | \$944 | +\$164 | +\$97 |
| | INSTGL78-2F | 13.5" | 78" | 2 3/4" | \$974 | +\$168 | +\$100 |
| | INSTGL84-2F | 13.5" | 84" | 2 3/4" | \$999 | +\$171 | +\$102 |
| | INSTGL90-2F | 13.5" | 90" | 2 3/4" | \$1030 | +\$178 | +\$105 |
| | INSTGL96-2F | 13.5" | 96" | 2 3/4" | \$1058 | +\$182 | +\$107 |

- Mid spine support legs support the Partial Height Benching spine when it is placed adjacent to another inline
- Glide option on spine support legs are black and gray with the exception on the 90° application legs coming in black only
- Wood spine support legs are available in Clear Oak (default), Black Oak and Clear Maple finishes
- Straight and T metal spine support legs are painted and available in all standard colors
- For freestanding height adjustable 90° applications the Metal T Legs must be use with a Bench Height Adjustable Foot Docking Bracket.
**See Worksurface Support section of this price list*
- The Height Adjustable Tables (2 or 3 stage base) found in the Ergonomic Price List are compatible with 90° applications in 48", 54" and 60" widths only

| | | Part number | H | Neutral paint/ base price | Accent paint |
|---|---|-------------------|-----|------------------------------|--------------|
|  | Mid Spine Support Leg for parallel applications only | INBMSL10 | 10" | \$248 | +\$27 |
|  | Straight Wood Partial Height Bench Frame Mid Spine Support Leg for 90° applications only | INBMSLW10 | 10" | \$292 | — |
|  | Metal T Partial Height Bench Frame Mid Spine Support Leg for 90° applications only | INBMSLT10 | 10" | \$385 | +\$42 |
|  | Straight Metal Partial Height Bench Frame Mid Spine Support Leg for 90° applications only | INBMSLSM10 | 10" | \$248 | +\$27 |



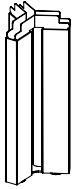

- Mid spine support legs support the Partial Height Benching spine when it is placed adjacent to another inline
- Glide option on spine support legs are black and gray with the exception on the 90° application legs coming in black only
- Straight and T metal spine support legs are painted and available in all standard colors





120° Mid Spine Support Leg

| Part number | H | Neutral paint/ base price | Accent paint |
|------------------|-----|------------------------------|--------------|
| INBYMSL10 | 10" | \$248 | +\$27 |

- End spine support leg supports the very end Partial Height Benching spine run
- 90° spine support legs supports the connection point when two Partial Height Benching spine frames are connected at a 90° angle
- Glide option on spine support legs is black
- Wood spine support legs are available in Clear Oak (default), Black Oak and Clear Maple finishes
- Straight and T metal spine support legs are painted and available in all standard colors
- Metal 90° spine support legs are intended to be installed on the worksurface supporting spine
- Metal 90° spine support legs are shipped right handed. if left handed is required, the legs can be field adjusted

| | | Part number | H | Neutral paint/ base price | Accent paint |
|---|---|--------------------|-----|------------------------------|--------------|
|  | Straight Wood Partial Height Bench Frame End Spine Support Leg for 90° applications only | INBESLW10 | 10" | \$292 | — |
|  | Metal T Partial Height Bench Frame End Spine Support Leg for 90° applications only | INBESLT10 | 10" | \$357 | +\$37 |
|  | Straight Metal Partial Height Bench Frame End Spine Support Leg for 90° applications only | INBESLSM10 | 10" | \$248 | +\$27 |
|  | Straight Wood Partial Height Bench Frame 90° Spine Support Leg for 90° applications only | INB90SLW10 | 10" | \$292 | — |
|  | Straight Metal Partial Height Bench Frame 90° Spine Support Leg for 90° applications only | INB90SLSM10 | 10" | \$248 | +\$27 |

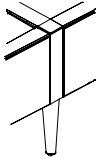
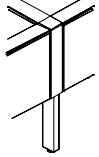
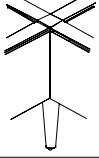
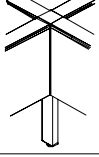
- Glide option on spine support legs is black
- Wood spine support legs are available in Clear Oak (default), Black Oak and Clear Maple finishes
- Metal spine support legs are painted and available in all standard colors
- 3-Way and 4-Way spine support legs are non-handed
- For freestanding height adjustable 90° applications the Metal T Legs must be use with a Bench Height Adjustable Foot Docking Bracket. See Worksurface Support setion of this price list
- The Height Adjustable Tables (2 or 3 stage base) found in the Ergonomic Price List are compatible with 90° applications in 48", 54" and 60" widths only

| | | Part number | H | Neutral paint/ base price | Accent paint |
|---|---|---------------------|-----|------------------------------|--------------|
|  | 3-Way Wood Partial Height Bench Frame Spine Support Leg for Mobile applications only | INB3SLW10 | 10" | \$288 | — |
|  | 3-Way Metal Partial Height Bench Frame Spine Support Leg for Mobile applications only | INB3SLSM10 | 10" | \$228 | +\$24 |
|  | 4-Way Wood Partial Height Bench Frame Spine Support Leg for Mobile applications only | INB4SLW10 | 10" | \$316 | — |
|  | 4-Way Metal Partial Height Bench Frame Spine Support Leg for Mobile applications only | INB4SLSM10 | 10" | \$262 | +\$27 |
|  | Freestanding Bench Spine Floor Docking Bracket | INBLAKESTBKT | — | \$17 | — |

- Inline Connectors are required to be specified when frames are connected inline
- Specified independently of frame and may span two frames.
- See Inscape System Application Guide
- All mounting hardware is included for corresponding frame thickness
- Top Trim up to 60" W requires two additional Jesters to be specified if spanning multiple frames (i.e. a 60" W top trim installed on two 30" frames)
- Stack-on End Trim (Hi-Lo End Trim) is specified when stack frames are specified





- End of line trim is specified when storage is being specified and there is visibility to the end of the frame (all other end conditions include finished appearance with no end trim needed)
- End of line trim can not be used on a stack on frame

NOTE

In order to get a total cost on products when upcharges are present take the list price of the product number and add the upcharge cost shown to the list price.

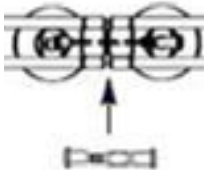
For example:

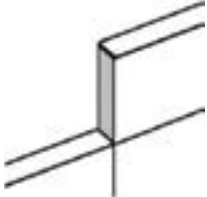

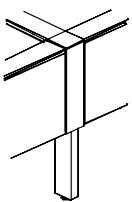
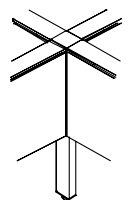

Product INTC30-2F in an accent paint would be \$60 +\$9

| | Part number | H | | | List price | | |
|---|--|------------------------------------|--------------------|-----------|-----------------------------------|-----------------|-------|
|  | Inline Connector Kit | INLINE-1 | All Stack on Frame | | | \$0 | |
| | | INLINE-2 | 24"h - 51"h Frame | | | \$0 | |
| | Part number | H | W | Thickness | Flat/neutral paint/ base price | Accent paint | |
|  | Top Cap | INTC30-2F | — | 30" | 2 ¾" | \$60 | +\$9 |
| | | INTC36-2F | — | 36" | 2 ¾" | \$65 | +\$10 |
| | | INTC42-2F | — | 42" | 2 ¾" | \$71 | +\$10 |
| | | INTC48-2F | — | 48" | 2 ¾" | \$73 | +\$11 |
| | | INTC54-2F | — | 54" | 2 ¾" | \$91 | +\$12 |
| | | INTC60-2F | — | 60" | 2 ¾" | \$97 | +\$13 |
| | | INTC66-2F | — | 66" | 2 ¾" | \$112 | +\$15 |
| | | INTC72-2F | — | 72" | 2 ¾" | \$118 | +\$15 |
| | | INTC78-2F | — | 78" | 2 ¾" | \$126 | +\$16 |
| | | INTC84-2F | — | 84" | 2 ¾" | \$137 | +\$17 |
| | | INTC90-2F | — | 90" | 2 ¾" | \$141 | +\$17 |
| | INTC96-2F | — | 96" | 2 ¾" | \$144 | +\$18 | |
|  | Hi-Lo End Trim | INETHL6.75-2F | 6.75" | — | 2 ¾" | \$27 | +\$7 |
| | | INBET10.125-2F | 10.125" | — | 2 ¾" | \$34 | +\$7 |
| | | INETHL13.5-2F | 13.5" | — | 2 ¾" | \$43 | +\$8 |
| | | INETHL20.25-2F | 20.25" | — | 2 ¾" | \$51 | +\$9 |
| | | INETHL27-2F | 27" | — | 2 ¾" | \$79 | +\$11 |
|  | End Trim For use with 2 ¾" T frames | INBET13.5-2F | 13.5" | — | 2 ¾" | \$39 | +\$8 |
| | | For use with Partial Height Frames | | | | | |
| | INBETEND27-2F | 25.61" | — | 2 ¾" | \$53 | +\$9 | |
| | For use with Full Height Frames | | | | | | |



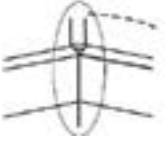

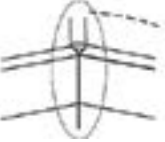
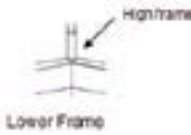
- Connector Kits include connector brackets, bolts, nuts and finished trim to create connection
- Connectors and trim are available in all of Inscape's standard paint colors
- Specify code based on height of frames within connection

| | | Part number | H | Neutral paint/ base price | Accent paint |
|---|---|--|-------|------------------------------|--------------|
|  | 90° Corner Connector for 90° applications only | INBCPLC13.5-2F with rounded profile | 13.5" | \$67 | +\$10 |
| | | INBCPLS13.5-2F with straight profile | 13.5" | \$67 | +\$10 |
|  | 3-Way Corner Connector for Mobile applications only | INBCPT13.5-2F | 13.5" | \$106 | +\$12 |
|  | 4-Way Corner Connector for Mobile applications only | INBCPX13.5-2F | 13.5" | \$46 | +\$6 |

- Connector Kits include connector brackets, bolts, nuts and finished trim to create connection
- Connectors and trim are available in all of Inscape's standard paint colors
- Specify code based on height of frames within connection
- Full Height to Partial Height Spine Trim finishes the full height bench frame when adjacent (inline) to a partial height spine frame

| | | Part number | H | Neutral paint/ base price | Accent paint |
|---|--|---------------------|---------|------------------------------|--------------|
|  | 120° Y Connector, Partial Height 2 3/4" Thick Frame - same height configurations | INCPYBPH-2F | 13.5" | \$77 | +\$11 |
| | | INCPYBFH-2F | 27" | \$168 | +\$20 |
|  | 120° Stack-On "V" Connector | INCPV6.75-2F | 6.75" | \$180 | +\$21 |
| | | INCPV10-2F | 10.125" | \$185 | +\$21 |
| | | INCPV13.5-2F | 13.5" | \$189 | +\$22 |
|  | 120° Stack-On "Y" Connector | INCPY6.75-2F | 6.75" | \$20 | +\$6 |
| | | INCPY10-2F | 10.125" | \$22 | +\$6 |
| | | INCPY13.5-2F | 13.5" | \$25 | +\$6 |
|  | 120° Stack-On End Trim, Multi Height | INST6.75Y-2F | 6.75" | \$180 | +\$21 |
| | | INST10Y-2F | 10.125" | \$185 | +\$21 |
| | | INST13.5Y-2F | 13.5" | \$189 | +\$22 |
|  | Full Height to Partial Height Spine Trim | INBPFHETC10 | 10" | \$76 | +\$10 |

- 23.6" H tiles may only be mounted on Full Height Bench spine
- Multi-access Tiles include cutouts for power and data
- Communication Tiles include cutouts for power or data
- Collaborative tiles have one cutout per tile and the cutouts are left or right justified making the tiles handed. They are intended to be specified to hide below the worksurface. Use one left and one right hand for each Bench Collaborative area

| | | Part number | H | W | Neutral paint/ base price | Accent paint |
|---|--|--|---------|-----|------------------------------|-----------------|
|  | 23.6" H Painted Tile | INB23.6P30 | 23.625" | 30" | \$96 | +\$12 |
| | | INB23.6P36 | 23.625" | 36" | \$112 | +\$15 |
| | | INB23.6P42 | 23.625" | 42" | \$120 | +\$16 |
| | | INB23.6P48 | 23.625" | 48" | \$135 | +\$17 |
| | | INB23.6P54 | 23.625" | 54" | \$145 | +\$18 |
| | | INB23.6P60 | 23.625" | 60" | \$168 | +\$20 |
|  | 23.6" H Painted Communication Tile | INB23.6CTP30 | 23.625" | 30" | \$178 | +\$21 |
| | | INB23.6CTP36 | 23.625" | 36" | \$183 | +\$21 |
| | | INB23.6CTP42 | 23.625" | 42" | \$194 | +\$22 |
| | | INB23.6CTP48 | 23.625" | 48" | \$204 | +\$23 |
| | | INB23.6CTP54 | 23.625" | 54" | \$225 | +\$25 |
| | | INB23.6CTP60 | 23.625" | 60" | \$229 | +\$25 |
|  | 23.6" H Painted Multi Access Tile | INB23.6MAP30 | 23.625" | 30" | \$178 | +\$21 |
| | | INB23.6MAP36 | 23.625" | 36" | \$183 | +\$21 |
| | | INB23.6MAP42 | 23.625" | 42" | \$194 | +\$22 |
| | | INB23.6MAP48 | 23.625" | 48" | \$204 | +\$23 |
| | | INB23.6MAP54 | 23.625" | 54" | \$225 | +\$25 |
| | | INB23.6MAP60 | 23.625" | 60" | \$229 | +\$25 |
|  | 23.6" H Painted Collaborative Communication Tile with single sided cutouts | INBCLB23CTP36UL | 23.625" | 36" | \$171 | +\$20 |
| | | INBCLB23CTP42UL cutout on the left (illustrated) | 23.625" | 42" | \$179 | +\$21 |
| | | INBCLB23CTP36UR | 23.625" | 36" | \$171 | +\$20 |
| | | INBCLB23CTP42UR cutout on the right | 23.625" | 42" | \$179 | +\$21 |

| | Part number | H | W | Grade 1/ COM/ base price | Grade 2 | Grade 3 | Grade 4 | Grade 5 | Grade 6 | Grade 7 | Grade 8 | Scrim |
|---|--|---------|-----|--------------------------------|---------|---------|---------|---------|---------|---------|---------|-------|
|  | INBCLB23CTF36UL | 23.625" | 36" | \$173 | +\$11 | +\$23 | +\$35 | +\$49 | +\$85 | +\$119 | +\$166 | +\$31 |
| | INBCLB23CTF42UL cutout on the left (illustrated) | 23.625" | 42" | \$177 | +\$13 | +\$26 | +\$37 | +\$51 | +\$88 | +\$124 | +\$171 | +\$34 |
| | INBCLB23CTF36UR | 23.625" | 36" | \$173 | +\$11 | +\$23 | +\$35 | +\$49 | +\$85 | +\$119 | +\$166 | +\$31 |
| | INBCLB23CTF42UR cutout on the right | 23.625" | 42" | \$177 | +\$13 | +\$26 | +\$37 | +\$51 | +\$88 | +\$124 | +\$171 | +\$34 |

23.6" H Fabric Collaborative Communication Tile with single sided cutouts

- 13.5" H tile may be specified with Partial Height Spine or Filing Spine
- Tiles are standard 13.5" H Inscape System
- 13.5" H Tiles may be specified on 13.5" stack on frame
- Tiles 66" W or wide span two frames. See Application Guide for frame spanning guidelines

NOTE

See finishes section for fabrics that require scrim
 Tile size limitations exist for some fabrics, see finishes section
 In order to get a total cost on products when upcharges are present take the list price of the product number and add the upcharge cost shown to the list price.

For example:

Product IN13.5F18 in a Grade 5 Fabric with Scrim would be \$98 +\$31 +\$16

| | Part number | H | W | Neutral paint/base price | Accent paint | |
|--|----------------------|------------------|-------|--------------------------|--------------|-------|
|  | 13.5" H Painted Tile | IN13.5P30 | 13.5" | 30" | \$71 | +\$10 |
| | | IN13.5P36 | 13.5" | 36" | \$72 | +\$11 |
| | | IN13.5P42 | 13.5" | 42" | \$74 | +\$11 |
| | | IN13.5P48 | 13.5" | 48" | \$77 | +\$11 |
| | | IN13.5P54 | 13.5" | 54" | \$81 | +\$11 |
| | | IN13.5P60 | 13.5" | 60" | \$86 | +\$12 |

| | | | | | | |
|---|-------------------------|-------------------|-------|-----|------|-------|
|  | 13.5" H Perforated Tile | IN13.5PF30 | 13.5" | 30" | \$86 | +\$12 |
| | | IN13.5PF36 | 13.5" | 36" | \$87 | +\$12 |
| | | IN13.5PF42 | 13.5" | 42" | \$88 | +\$12 |
| | | IN13.5PF48 | 13.5" | 48" | \$91 | +\$12 |
| | | IN13.5PF54 | 13.5" | 54" | \$92 | +\$12 |
| | | IN13.5PF60 | 13.5" | 60" | \$94 | +\$12 |

| | Part number | H | W | Grade 1/ COM/ base price | Grade 2 | Grade 3 | Grade 4 | Grade 5 | Grade 6 | Grade 7 | Grade 8 | Scrim | |
|---|---------------------|------------------|-------|--------------------------------|---------|---------|---------|---------|---------|---------|---------|--------|-------|
|  | 13.5" H Fabric Tile | IN13.5F18 | 13.5" | 18" | \$98 | +\$7 | +\$22 | +\$24 | +\$31 | +\$46 | +\$61 | +\$87 | +\$16 |
| | | IN13.5F24 | 13.5" | 24" | \$101 | +\$7 | +\$24 | +\$27 | +\$34 | +\$45 | +\$60 | +\$86 | +\$16 |
| | | IN13.5F30 | 13.5" | 30" | \$105 | +\$8 | +\$26 | +\$33 | +\$37 | +\$45 | +\$61 | +\$87 | +\$17 |
| | | IN13.5F36 | 13.5" | 36" | \$110 | +\$12 | +\$26 | +\$35 | +\$45 | +\$67 | +\$92 | +\$128 | +\$17 |
| | | IN13.5F42 | 13.5" | 42" | \$116 | +\$15 | +\$27 | +\$36 | +\$47 | +\$72 | +\$98 | +\$135 | +\$18 |
| | | IN13.5F48 | 13.5" | 48" | \$120 | +\$15 | +\$27 | +\$36 | +\$47 | +\$72 | +\$99 | +\$137 | +\$18 |
| | | IN13.5F54 | 13.5" | 54" | \$124 | +\$16 | +\$29 | +\$42 | +\$52 | +\$81 | +\$106 | +\$147 | +\$20 |
| | | IN13.5F60 | 13.5" | 60" | \$129 | +\$16 | +\$29 | +\$42 | +\$52 | +\$81 | +\$106 | +\$147 | +\$20 |
| | | IN13.5F66 | 13.5" | 66" | \$239 | +\$17 | +\$29 | +\$42 | +\$52 | +\$83 | +\$107 | +\$151 | +\$93 |
| | | IN13.5F72 | 13.5" | 72" | \$243 | +\$17 | +\$18 | +\$25 | +\$33 | +\$66 | +\$99 | +\$137 | +\$94 |
| | | IN13.5F78 | 13.5" | 78" | \$245 | +\$17 | +\$20 | +\$27 | +\$35 | +\$71 | +\$105 | +\$146 | +\$94 |
| | | IN13.5F84 | 13.5" | 84" | \$255 | +\$18 | +\$20 | +\$27 | +\$35 | +\$71 | +\$105 | +\$146 | +\$96 |
| | IN13.5F90 | 13.5" | 90" | \$256 | +\$18 | +\$21 | +\$31 | +\$42 | +\$77 | +\$112 | +\$157 | +\$118 | |
| | IN13.5F96 | 13.5" | 96" | \$259 | +\$19 | +\$22 | +\$33 | +\$45 | +\$84 | +\$119 | +\$166 | +\$118 | |

| | | | | | | | | | | | | | |
|---|-----------------------|-------------------|-------|-----|-------|-------|-------|-------|-------|-------|--------|--------|-------|
|  | 13.5" H Tackable Tile | IN13.5TK18 | 13.5" | 18" | \$145 | +\$7 | +\$11 | +\$20 | +\$29 | +\$51 | +\$73 | +\$102 | +\$25 |
| | | IN13.5TK24 | 13.5" | 24" | \$151 | +\$8 | +\$12 | +\$21 | +\$29 | +\$52 | +\$74 | +\$103 | +\$27 |
| | | IN13.5TK30 | 13.5" | 30" | \$156 | +\$9 | +\$12 | +\$21 | +\$29 | +\$53 | +\$77 | +\$106 | +\$29 |
| | | IN13.5TK36 | 13.5" | 36" | \$160 | +\$12 | +\$22 | +\$32 | +\$44 | +\$73 | +\$103 | +\$143 | +\$30 |
| | | IN13.5TK42 | 13.5" | 42" | \$165 | +\$13 | +\$23 | +\$33 | +\$45 | +\$76 | +\$106 | +\$147 | +\$32 |
| | | IN13.5TK48 | 13.5" | 48" | \$187 | +\$13 | +\$23 | +\$35 | +\$48 | +\$84 | +\$115 | +\$161 | +\$33 |

Architecture

Tiles

Partial Height Spine Tiles

Bench

- 13.5" H tile may be specified with Partial Height Spine or Filing Spine
- Tiles are standard 13.5" H Inscape System
- May be specified on Stack-on Frame
- When specifying monitor arms to mount on paper management tile, reinforcing bracket must be specified
- Reinforcement Kit includes reinforcing brackets for Paper Management Tile

| | | Part number | H | W | Nuform Classic/ List/base price | Nuform Select |
|---|---------------------|-------------------|-------|-----|------------------------------------|------------------|
|  | 13.5" H Nuform Tile | IN13.5NF30 | 13.5" | 30" | \$263 | +\$30 |
| | | IN13.5NF36 | 13.5" | 36" | \$274 | +\$31 |
| | | IN13.5NF42 | 13.5" | 42" | \$286 | +\$33 |
| | | IN13.5NF48 | 13.5" | 48" | \$293 | +\$33 |

| | | Part number | H | W | | |
|---|-------------------------|-------------------|-------|-----|-------|---|
|  | 13.5" H Whiteboard Tile | IN13.5WB30 | 13.5" | 30" | \$103 | — |
| | | IN13.5WB36 | 13.5" | 36" | \$105 | — |
| | | IN13.5WB42 | 13.5" | 42" | \$107 | — |
| | | IN13.5WB48 | 13.5" | 48" | \$114 | — |
| | | IN13.5WB54 | 13.5" | 54" | \$127 | — |
| | | IN13.5WB60 | 13.5" | 60" | \$132 | — |
| | | IN13.5WB66 | 13.5" | 66" | \$227 | — |
| | | IN13.5WB72 | 13.5" | 72" | \$234 | — |
| | | IN13.5WB78 | 13.5" | 78" | \$245 | — |
| | | IN13.5WB84 | 13.5" | 84" | \$250 | — |
| | | IN13.5WB90 | 13.5" | 90" | \$255 | — |
| IN13.5WB96 | 13.5" | 96" | \$262 | — | | |

| | | Part number | H | W | Neutral paint/ base price | Accent paint |
|---|--|----------------------|-------|-------|------------------------------|-----------------|
|  | 6.75" H Paper Management Tile for use with 2 3/4" T frames | IN6.75PM30-2F | 6.75" | 30" | \$160 | +\$19 |
| | | IN6.75PM36-2F | 6.75" | 36" | \$174 | +\$20 |
| | | IN6.75PM42-2F | 6.75" | 42" | \$195 | +\$22 |
| | | IN6.75PM48-2F | 6.75" | 48" | \$211 | +\$23 |
| | | IN6.75PM54-2F | 6.75" | 54" | \$227 | +\$25 |
| | | IN6.75PM60-2F | 6.75" | 60" | \$249 | +\$27 |
| | | IN6.75PM66-2F | 6.75" | 66" | \$328 | +\$34 |
| | | IN6.75PM72-2F | 6.75" | 72" | \$341 | +\$36 |
| | | IN6.75PM78-2F | 6.75" | 78" | \$353 | +\$37 |
| | | IN6.75PM84-2F | 6.75" | 84" | \$401 | +\$44 |
| | | IN6.75PM90-2F | 6.75" | 90" | \$414 | +\$45 |
| IN6.75PM96-2F | 6.75" | 96" | \$429 | +\$46 | | |

| | | | | | | |
|---|---|------------------|---|-----|-------|---|
|  | Paper Management Reinforcing Kit for use with 2 3/4" T frames | INPMRK-2F | — | 18" | \$126 | — |
|---|---|------------------|---|-----|-------|---|





Architecture

Tiles

Partial Height Spine Tiles

Bench

- 13.5" H tile may be specified with Partial Height Spine or Filing Spine
- Tiles are standard 13.5" H Inscape System
- 13.5" H tiles may be specified on 13.5" Stack-on Frame
- Multi-access Tiles include cutouts for power and data
- Communication Tiles include cutouts for power or data
- Collaborative communication and multi-access tiles with single sided cutouts have one cutout per tile (2 stacked for multi-access) and the cutouts are left or right justified making the tiles handed. They are intended to be specified so that the cutouts are hidden below the worksurface
- Use one left and one right hand collaborative communication tile for each Bench Collaborative area

| | | Part number | H | W | Neutral paint/ base price | Accent paint | |
|---|---|----------------------------------|-------|-----|------------------------------|-----------------|--|
|  | 13.5" H Painted Communication Tile Upper Deck Location | IN13.5CTP24-UD | 13.5" | 24" | \$99 | +\$13 | |
| | | IN13.5CTP30-UD | 13.5" | 30" | \$102 | +\$13 | |
| | | IN13.5CTP36-UD | 13.5" | 36" | \$107 | +\$15 | |
| | | IN13.5CTP42-UD | 13.5" | 42" | \$112 | +\$15 | |
| | | IN13.5CTP48-UD | 13.5" | 48" | \$119 | +\$15 | |
| | | IN13.5CTP54-UD | 13.5" | 54" | \$120 | +\$16 | |
| | | IN13.5CTP60-UD | 13.5" | 60" | \$124 | \$124 | |
|  | 13.5" H Painted Multi Access Tile | IN13.5MAP30-UD | 13.5" | 30" | \$103 | +\$13 | |
| | | IN13.5MAP36-UD | 13.5" | 36" | \$107 | +\$15 | |
| | | IN13.5MAP42-UD | 13.5" | 42" | \$112 | +\$15 | |
| | | IN13.5MAP48-UD | 13.5" | 48" | \$119 | +\$15 | |
| | | IN13.5MAP54-UD | 13.5" | 54" | \$120 | +\$16 | |
| | | IN13.5MAP60-UD | 13.5" | 60" | \$124 | +\$16 | |
|  | 13.5" H Painted Collaborative Communication Tile with single sided cutouts | INBCLB13CTP36UL | 13.5" | 36" | \$96 | +\$12 | |
| | | INBCLB13CTP42UL | 13.5" | 42" | \$101 | +\$13 | |
| | | cutout on the left (illustrated) | | | | | |
| | | INBCLB13CTP36UR | 13.5" | 36" | \$96 | +\$12 | |
| | | INBCLB13CTP42UR | 13.5" | 42" | \$101 | +\$13 | |
| cutout on the right | | | | | | | |
|  | 13.5" H Painted Multi Access Tile with single sided cutouts | IN13.5MAP60UL | 13.5" | 60" | \$124 | +\$16 | |
| | | IN13.5MAP72UL | 13.5" | 72" | \$239 | +\$26 | |
| | | cutout on the left (illustrated) | | | | | |
| | | IN13.5MAP60UR | 13.5" | 60" | \$124 | +\$16 | |
| | | IN13.5MAP72UR | 13.5" | 72" | \$239 | +\$26 | |
| | | cutout on the right | | | | | |

- 13.5" H tile may be specified with Partial Height Spine or Filing Spine
- Tiles are standard 13.5" H Inscape System
- 13.5" H tiles may be specified on 13.5" Stack-on Frame
- Multi-access Tiles include cutouts for power and data
- Communication Tiles include cutouts for power or data
- Collaborative communication and multi-access tiles with single sided cutouts have one cutout per tile (2 stacked for multi-access) and the cutouts are left or right justified making the tiles handed. They are intended to be specified so that the cutouts are hidden below the worksurface
- Use one left and one right hand collaborative communication tile for each Bench Collaborative area

NOTE





See finishes section for fabrics that require scrim

Tile size limitations exist for some fabrics, see finishes section

In order to get a total cost on products when upcharges are present take the list price of the product number and add the upcharge cost shown to the list price.

For example:

Product IN13.5CTF24-UD in a Grade 5 Fabric with Scrim would be \$114 +\$31 +\$16

| | Part number | H | W | Grade 1/ COM/ base price | Grade 2 | Grade 3 | Grade 4 | Grade 5 | Grade 6 | Grade 7 | Grade 8 | Scrim |
|--|------------------------|-------|-----|--------------------------------|---------|---------|---------|---------|---------|---------|---------|-------|
|  13.5" H Fabric Communication Tile Upper Deck Location | IN13.5CTF24-UD | 13.5" | 24" | \$114 | +\$9 | +\$15 | +\$23 | +\$31 | +\$54 | +\$79 | +\$108 | +\$16 |
| | IN13.5CTF30-UD | 13.5" | 30" | \$119 | +\$8 | +\$12 | +\$21 | +\$29 | +\$53 | +\$77 | +\$106 | +\$17 |
| | IN13.5CTF36-UD | 13.5" | 36" | \$131 | +\$9 | +\$16 | +\$27 | +\$39 | +\$69 | +\$98 | +\$135 | +\$17 |
| | IN13.5CTF42-UD | 13.5" | 42" | \$134 | +\$10 | +\$20 | +\$29 | +\$37 | +\$71 | +\$100 | +\$140 | +\$18 |
| | IN13.5CTF48-UD | 13.5" | 48" | \$139 | +\$12 | +\$25 | +\$35 | +\$46 | +\$76 | +\$106 | +\$147 | +\$18 |
| | IN13.5CTF54-UD | 13.5" | 54" | \$140 | +\$13 | +\$27 | +\$39 | +\$50 | +\$84 | +\$114 | +\$160 | +\$20 |
| | IN13.5CTF60-UD | 13.5" | 60" | \$153 | +\$15 | +\$16 | +\$27 | +\$42 | +\$73 | +\$105 | +\$146 | +\$20 |
|  13.5" H Fabric Multi Access Tile Upper Deck Location | IN13.5MAF30-UD | 13.5" | 30" | \$120 | +\$8 | +\$12 | +\$21 | +\$29 | +\$53 | +\$77 | +\$106 | +\$17 |
| | IN13.5MAF36-UD | 13.5" | 36" | \$131 | +\$9 | +\$16 | +\$27 | +\$39 | +\$69 | +\$98 | +\$135 | +\$17 |
| | IN13.5MAF42-UD | 13.5" | 42" | \$134 | +\$10 | +\$23 | +\$29 | +\$44 | +\$72 | +\$103 | +\$143 | +\$18 |
| | IN13.5MAF48-UD | 13.5" | 48" | \$139 | +\$12 | +\$25 | +\$35 | +\$46 | +\$76 | +\$106 | +\$147 | +\$18 |
| | IN13.5MAF54-UD | 13.5" | 54" | \$140 | +\$13 | +\$27 | +\$39 | +\$50 | +\$84 | +\$114 | +\$160 | +\$20 |
| | IN13.5MAF60-UD | 13.5" | 60" | \$153 | +\$15 | +\$30 | +\$43 | +\$52 | +\$87 | +\$116 | +\$162 | +\$20 |
|  13.5" H Fabric Collaborative Communication Tile with single sided cutouts | INBCLB13CTF36UL | 13.5" | 36" | \$119 | +\$8 | +\$15 | +\$26 | +\$37 | +\$66 | +\$96 | +\$132 | +\$16 |
| | INBCLB13CTF42UL | 13.5" | 42" | \$125 | +\$9 | +\$19 | +\$27 | +\$43 | +\$69 | +\$99 | +\$137 | +\$17 |
| | INBCLB13CTF36UR | 13.5" | 36" | \$119 | +\$8 | +\$15 | +\$26 | +\$37 | +\$66 | +\$96 | +\$132 | +\$16 |
| | INBCLB13CTF42UR | 13.5" | 42" | \$125 | +\$9 | +\$19 | +\$27 | +\$43 | +\$69 | +\$99 | +\$137 | +\$17 |
|  13.5" H Fabric Multi Access Tile with single sided cutouts | IN13.5MAF60UL | 13.5" | 60" | \$153 | +\$16 | +\$29 | +\$42 | +\$52 | +\$81 | +\$106 | +\$147 | +\$20 |
| | IN13.5MAF72UL | 13.5" | 72" | \$295 | +\$26 | +\$53 | +\$74 | +\$98 | +\$151 | +\$201 | +\$281 | +\$54 |
| | IN13.5MAF60UR | 13.5" | 60" | \$153 | +\$16 | +\$29 | +\$42 | +\$52 | +\$81 | +\$106 | +\$147 | +\$20 |
| | IN13.5MAF72UR | 13.5" | 72" | \$295 | +\$26 | +\$53 | +\$74 | +\$98 | +\$151 | +\$201 | +\$281 | +\$54 |

- Tiles may only be installed on 10.125" H Stack-on
- May be specified on a Stack-on Frame
- Multi-access Tiles include cutouts for power and data
- Communication Tiles include cutouts for power or data



NOTE

See finishes section for fabrics that require scrim
 Tile size limitations exist for some fabrics, see finishes section

In order to get a total cost on products when upcharges are present take the list price of the product number and add the upcharge cost shown to the list price.

For example:

Product IN10.125F30 in a Grade 5 Fabric with Scrim would be \$105 +\$26 +\$17

| | | Part number | H | W | Neutral paint/ base price | Accent paint |
|---|--------------------------------------|------------------------|---------|-----|------------------------------|-----------------|
|  | 10.125" H Painted Tile | IN10.125P30 | 10.125" | 30" | \$71 | +\$10 |
| | | IN10.125P36 | 10.125" | 36" | \$72 | +\$11 |
| | | IN10.125P42 | 10.125" | 42" | \$74 | +\$11 |
| | | IN10.125P48 | 10.125" | 48" | \$77 | +\$11 |
| | | IN10.125P54 | 10.125" | 54" | \$81 | +\$11 |
| | | IN10.125P60 | 10.125" | 60" | \$86 | +\$12 |
|  | 10.125" H Painted Multi-Access Tile | IN10.12MAP30-UD | 10.125" | 30" | \$102 | +\$13 |
| | | IN10.12MAP36-UD | 10.125" | 36" | \$107 | +\$15 |
| | | IN10.12MAP42-UD | 10.125" | 42" | \$112 | +\$15 |
| | | IN10.12MAP48-UD | 10.125" | 48" | \$119 | +\$15 |
| | | IN10.12MAP54-UD | 10.125" | 54" | \$120 | +\$16 |
| | | IN10.12MAP60-UD | 10.125" | 60" | \$124 | +\$16 |
|  | 10.125" H Painted Communication Tile | IN10.12CTP30-UD | 10.125" | 30" | \$102 | +\$13 |
| | | IN10.12CTP36-UD | 10.125" | 36" | \$107 | +\$15 |
| | | IN10.12CTP42-UD | 10.125" | 42" | \$112 | +\$15 |
| | | IN10.12CTP48-UD | 10.125" | 48" | \$119 | +\$15 |
| | | IN10.12CTP54-UD | 10.125" | 54" | \$120 | +\$16 |
| | | IN10.12CTP60-UD | 10.125" | 60" | \$124 | +\$16 |

- Tiles may only be installed on 10.125" H Stack on
- May be specified on a Stack-On Frame
- Multi Access Tiles include cutouts for power and data
- Communication Tiles include cutouts for power or data

NOTE



See finishes section for fabrics that require scrim

Tile size limitations exist for some fabrics, see finishes section

In order to get a total cost on products when upcharges are present take the list price of the product number and add the upcharge cost shown to the list price.

For example:

Product IN10.125F30 in a Grade 5 Fabric with Scrim would be \$105 +\$26 +\$17

| | Part number | H | W | Grade 1/ COM/ base price | Grade 2 | Grade 3 | Grade 4 | Grade 5 | Grade 6 | Grade 7 | Grade 8 | Scrim |
|---|------------------------|---------|-----|--------------------------------|---------|---------|---------|---------|---------|---------|---------|-------|
|  10.125" H Fabric Tile | IN10.125F30 | 10.125" | 30" | \$105 | +\$8 | +\$12 | — | +\$26 | — | +\$61 | — | +\$17 |
| | IN10.125F36 | 10.125" | 36" | \$110 | +\$12 | +\$26 | — | +\$45 | — | +\$92 | — | +\$17 |
| | IN10.125F42 | 10.125" | 42" | \$116 | +\$11 | +\$27 | — | +\$47 | — | +\$98 | — | +\$18 |
| | IN10.125F48 | 10.125" | 48" | \$120 | +\$15 | +\$27 | — | +\$47 | — | +\$99 | — | +\$18 |
| | IN10.125F54 | 10.125" | 54" | \$124 | +\$16 | +\$29 | — | +\$52 | — | +\$106 | — | +\$20 |
| | IN10.125F60 | 10.125" | 60" | \$129 | +\$16 | +\$29 | — | +\$52 | — | +\$106 | — | +\$20 |
|  10.125" H Fabric Multi-Access Tile | IN10.12MAF30-UD | 10.125" | 30" | \$119 | +\$8 | +\$12 | — | +\$29 | — | +\$77 | — | +\$17 |
| | IN10.12MAF36-UD | 10.125" | 36" | \$131 | +\$9 | +\$16 | — | +\$39 | — | +\$98 | — | +\$17 |
| | IN10.12MAF42-UD | 10.125" | 42" | \$134 | +\$8 | +\$20 | — | +\$37 | — | +\$98 | — | +\$18 |
| | IN10.12MAF48-UD | 10.125" | 48" | \$139 | +\$12 | +\$25 | — | +\$46 | — | +\$106 | — | +\$18 |
| | IN10.12MAF54-UD | 10.125" | 54" | \$140 | +\$13 | +\$27 | — | +\$50 | — | +\$114 | — | +\$20 |
| | IN10.12MAF60-UD | 10.125" | 60" | \$153 | +\$6 | +\$16 | — | +\$42 | — | +\$105 | — | +\$20 |
|  10.125" H Fabric Communication Tile | IN10.12CTF30-UD | 10.125" | 30" | \$119 | +\$8 | +\$12 | — | +\$29 | — | +\$77 | — | +\$17 |
| | IN10.12CTF36-UD | 10.125" | 36" | \$131 | +\$9 | +\$16 | — | +\$39 | — | +\$98 | — | +\$17 |
| | IN10.12CTF42-UD | 10.125" | 42" | \$134 | +\$8 | +\$20 | — | +\$37 | — | +\$98 | — | +\$18 |
| | IN10.12CTF48-UD | 10.125" | 48" | \$139 | +\$12 | +\$25 | — | +\$46 | — | +\$106 | — | +\$18 |
| | IN10.12CTF54-UD | 10.125" | 54" | \$140 | +\$13 | +\$27 | — | +\$50 | — | +\$114 | — | +\$20 |
| | IN10.12CTF60-UD | 10.125" | 60" | \$153 | +\$6 | +\$16 | — | +\$42 | — | +\$105 | — | +\$20 |

Bench Technology

inscape

work for tomorrow

Inscape Bench electrical is UL and CSA approved. New York City and Chicago solutions are also available as standard offering. The electrical system features 8 wires and 4 circuits that can be configured in a 2+2 or 3+1 circuit configuration. All electrical components, with the exception of the power feed (which must be connected to the building power supply by a licensed electrician) may be installed by furniture installers, unless otherwise stated by jurisdiction of the installation.

Inscape Bench electrical components consist of the following: Floor/Wall power in-feed, power tracks, jumper cables and duplex receptacles. Power components snap into place without the need of tools and are the same components as offered in Inscape System.

POWER IN-FEED

Power In-Feed connections can be made through a wall, column, or floor connection. Power in-feed connections for Full Height applications consist of an 84" long liquid tight cable and a 45" flex cable connected by a 3" metal coupler and elbow joint to sit between bottom rails. Power in-feed connections for Partial Height applications consist of an 84" long liquid tight cable and a 12" flex cable connected by a 3" metal coupler and elbow joint to sit between bottom rails. The liquid tight portion of the Power in-feed must be connected to the building power supply by an electrician. If two power feeds are being specified for one cluster of stations, care must be taken not to cross connect the two feeds through jumper cables and power tracks.

Two versions of the power in-feed exist. One version is to be used with the Full Height Spine and the other is to be used with the Partial height or Storage Spine and includes a wire casing.

NEW YORK CITY IN-FEED

New York City has requirements for special power entry assemblies. A qualified electrician is required to hard-wire the New York City In-Feed from the entry box to the power source. The New York City feed works for side feed, end feed or ceiling feed.

CITY OF CHICAGO HOLD DOWN BRACKET

The City of Chicago does not permit the use of pre-wired modular electrical systems. To simplify hardwiring of the Inscape Bench Spine, the City of Chicago Hold Down Bracket (INECHB) is available. Specify two INECHB for each power entry point, one for the power feed and one for the outlet. (The outlet box is NOT supplied by Inscape). INECHB's are available in packages of 6.

Boxes should be sourced through Ental Industries or J&A Sheet both local Chicago suppliers of electrical junction boxes.

NOTE: Spines 30" W will accept one double-sided outlet box. Spines 36" W and wider will accept two boxes. INECHB's may also be specified to mount multi-user termination boxes inside the panel.

POWER POLE

The Bench power pole brings power and data into the station from the ceiling. It includes a split top trim to facilitate cable entry into the spine panel, a ceiling grommet, an optional 16' or 22' long electrical cable and an expandable power pole featuring a septum to separate power from data cables to avoid electromagnetic interference (EMI). Specify ceiling power pole according to panel width as well as an optional selection for A Leg applications, which includes a bottom cover that conceals cables running from the bottom of the channel up to the frame. An electrician must connect the ceiling power entry cable to the building power supply. If two power feeds are specified for one cluster of stations, care must be taken not to cross connect the two feeds through jumper cables and power tracks. The entire power pole accommodates 61 Cat6 and 78 Cat5 cables at a 60% fill capacity if no electrical cable is routed through pole. If electrical is routed within power pole, at a 60% fill capacity, 46 Cat6 and 59 Cat5 cables may be accommodated

2 + 2 CIRCUIT CONFIGURATION

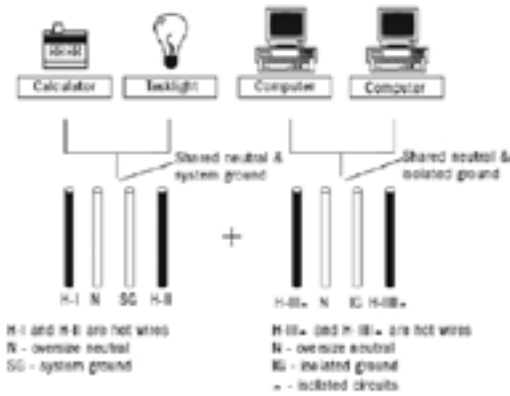

2+2

- Circuits #1 and #2 share one oversized neutral and one shared ground to provide convenience power for task lights, calculators, radios etc.
- Circuits #3 and #4 share the other oversized neutral and isolated ground to provide isolated power to computers.

3+ 1 CIRCUIT CONFIGURATION

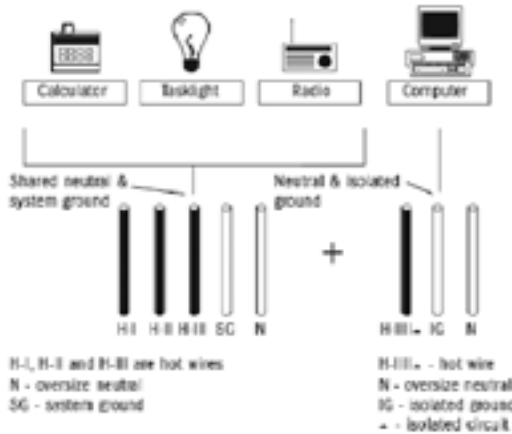

- Circuits #1, #2 and #3 share one oversized neutral and one shared ground to provide convenience power for task lights, calculators, radios etc.
- Circuit #4 uses the other oversized neutral and isolated ground to provide isolated power to computers.

POWER TRACK KITS

Power Track Kits consist of a power track and clips to attach the power track to a crossrail. The kit allows for power tracks to be mounted in specified locations (above or below the worksurface). Jumper cables and receptacles are specified separately. The 30" W Power Track Kit accepts one duplex per side. Power Track Kits which are 36" W and wider accept two duplexes per side. Power Track Kits may be specified below the following; Transaction Tops, Up mount Bins, Stack on Glaze, Add on Glaze and Double Glazed Tiles. Power Track Kits MAY NOT be specified below Twin Bins or Power Poles.

JUMPER CABLES

Jumper Cables by-pass non-powered spines and also facilitates connections from power track to power track. Jumper cables must attach to power tracks only and cannot be attached to adjacent jumper cables or power in-feeds. Product codes indicate the width of the jumper cable which may be cross-referenced in the Inscape Bench Application Guide. Various widths of jumper cables are available to facilitate various applications and configurations. See Inscape Bench Application Guide for details.

DUPLEX RECEPTACLES

Duplex Receptacles snap into power tracks back-to-back and may be accessed through cutouts in either the electrical cover plate with standard frames or multi-access and communication tiles in all other locations and basic frames. Duplexes are interchangeable amongst the varying power track locations. Specify duplexes according to circuit configuration, 2+2 or 3+1. The IN2D3- duplex is specific to 2+2 wire configurations and the IN2DU3- duplex is specified for 3+1 wire configurations. General rule is no more than 12 receptacles per circuit per power in feed. Duplexes may be specified in black, white (close match to P168 – Glacier White) and gray (close match to P290 – Aluminum Leaf).

Controlled receptacles to satisfy California Title 24 are available. These receptacles control circuits through building switches. When circuits are controlled through building switches, it is required to identify which circuit is controlled to the end user. To identify the receptacles on the controlled circuit, Inscape's controlled receptacles have a power mark (circle with the vertical line). The fit and function of these receptacles are same as the standard receptacle offering only application is in controlled circuits.

DATA COMPONENTS

HINGED COVER (INHRC)

The hinged cover (INHRC) snaps into the cutouts which are found in multi access and communication tiles. When data faceplates and receptacles are not required the hinged cover provides a visual and protective cover.

FIBER OPTIC OUTLET

Fiber optic outlet (INCFO) is specified to be installed in a cutout in a multi access or communication tile. May be specified in black, white (close match to P168 – Glacier White) and gray (close match to P290 – Aluminum Leaf).

DATA AND COMMUNICATION FACEPLATE

The **Data and Communication Faceplate (INCDP)** installs in a cutout in a multi access or communication tile where plug and play access is required. The faceplate provides three “slots” where the **Category 5 (INCABRJ45)**, **Category 6 (INCABR6J45)**, and/or **Telephone Jacks (INCRJ11)** may be inserted. All “openings” need to be filled with data or phone jacks, the **Blank Data Plate Insert (INCB)** fills in any which are not being used. Data components may be specified in black, white (close match to P168 – Glacier White) and gray (close match to P290 – Aluminum Leaf). Telephone Jacks (INCRJ11) are not available in gray. Data Communication Plates (INCDP) are not currently available in white.

CLAMP ON POWER MODULES

Clamp-on power may be clamped along edge of worksurface for plug and play access to electrical/voice/data. Power Modules plug into the duplexes and attach to 1” and 1 ¼” thick worksurfaces.

The Clamp-On Power Module has a 3 receptacle/1 dual USB port configuration and is available in a black or white finish. It has a 96” long power cord and LED surge protection indication. The mount includes a device holder.

The Clamp-On Power Module with Colored Components comes in many different configurations with receptacles, USB (1 type A and 1 type B) ports and availability lights. Power Modules come in black, white or gray and have colored options for the lid; Black, White, Teal, Red, Purple, Blue, Green, Gray. The availability light is user controlled and requires free software download.

CABLE HOOKS

Cable Hooks support and segregate data cables. Each frame 37” and higher ships with one cable manager. Cable hooks carry data cables to their termination voice/data point at a multi access or communication tile for plug and play access or to hanger brackets which are located behind the tile.



WIRE MANAGEMENT CLIPS

Wire Management Clips are required when power is being routed from a Credenza Storage benching application frame to the worksurface. Where cabling is running from behind a Credenza Storage case, these wire management clips are mounted to the underside of the inside of the case and the wires are cleanly routed to the main surface. These clips come in a package of 10 and are white in color.

WIRE CASING

Wire casing manages cables and technology from a worksurface to the floor. Casing is 29” long but can be adjustable in length by removing or adding “links”. Casing is available in gray. As standard the wire casing accommodates 28.5” H worksurface heights. The wire casing accommodates 30 Cat5 cables with electrical works at a 60% fill capacity which is recommended. Approximately 36 Cat5 cables may be accommodated in the wire casing at a 60% fill capacity without electrical works.

- Partial Height In Feed Kit is slightly shorter than the Full Height Kit and includes wire management casing
- All electrical components are standard 8 wire configuration
- New York City Power In-Feed Kit is for use with a full height spine. To use it with Partial Height or Storage spine application, a wire management casing (INBFWC) needs to be specified
- The power pole is expandable and comes standard with a 16" whip. It also has the option of no power or can accommodate a 22" whip



| | | Part number | List price |
|---|--|--|------------|
|  | Standard Floor/Wall Power In Feed Kits | INEFWK-8 (use with full spine) | \$361 |
| | | INBFWK-8 (use with partial height spine) | \$641 |
|  | New York City Power In Feed Kit | INEFWK-NY-8 | \$641 |
|  | Wire Management Casing Gray | INBFWC | \$130 |

| | Part number | Neutral paint/ base price | Optional 22" whip | No power option | Accent paint | |
|---|-------------|------------------------------|----------------------|--------------------|-----------------|--------|
|  | Power Pole | INBPWRPOLE-8 | \$1595 | +\$225 | -\$238 | +\$166 |

- All electrical components are standard 8 wire configuration
- See Inscape System Application Guide for jumper cable length requirements for varying panel configurations
- Jumper Cables do not connect together nor do they attach to power in feeds

NOTES

- Power tracks are required to match the width of the frame they are being installed in
- Power Track Kits may be specified below the following; Transaction Tops, Up mount Bins, Stack on Glaze, Add on Glaze and Double Glazed Tiles
- Power Track Kits MAY NOT be specified below Twin Bins or Power Poles

| | | Part number | W | List price |
|---|----------------------------------|----------------------|------|------------|
|  | Power Track Kit | INRUDKIT-30-8 | 30" | \$185 |
| | | INRUDKIT-36-8 | 36" | \$201 |
| | | INRUDKIT-42-8 | 42" | \$219 |
| | | INRUDKIT-48-8 | 48" | \$238 |
| | | INRUDKIT-54-8 | 54" | \$253 |
| | | INRUDKIT-60-8 | 60" | \$273 |
|  | Electrified Twin-Bin Power Track | INETPTWB-8 | 8" | \$88 |
|  | Jumper Cables | INETC24-8 | 24" | \$72 |
| | | INETC25-8 | 25" | \$72 |
| | | INETC28-8 | 28" | \$72 |
| | | INETC31-8 | 31" | \$74 |
| | | INETC44-8 | 44" | \$79 |
| | | INETC53-8 | 53" | \$88 |
| | | INETC64-8 | 64" | \$104 |
| | | INETC88-8 | 88" | \$135 |
| | | INETC104-8 | 104" | \$156 |
| | | INETC122-8 | 122" | \$192 |
| | | INETC141-8 | 141" | \$194 |
| INETC158-8 | 158" | \$212 | | |
| INETC182-8 | 182" | \$243 | | |



- All electrical components are standard 8 wire configuration
- Circuit 3 receptacle requires 2+2 or 3+1 wire designation (“U” in the code signifies 3+1 wire configuration)
- White is a close match to 168 Glacier White, Gray is a close match to 290 Aluminum Leaf
- The “UD” duplexes are to be specified in conjunction with the Electrified Twin Bin (Inscape System Price List)
- Controlled receptacles satisfy California Title 24 and are indicated with a “power mark” which is represented by a circle with a line

NOTES

In order to get a total cost on products when upcharges are present take the list price of the product number and add the upcharge cost shown to the list price.

For example:

Product IN2D1-8 in Gray would be +\$27 +\$11

| | Part number | Black/ base price | White | Gray | |
|---|---|----------------------|-------|-------|-------|
|  | Receptacle for cutout tiles application in 2 3/4" frames | IN2D1-8 | \$27 | +\$11 | +\$11 |
| | | IN2D2-8 | \$27 | +\$11 | +\$11 |
| | | IN2D3-8 | \$27 | +\$11 | +\$11 |
| | | IN2D3U-8 | \$27 | +\$11 | +\$11 |
| | | IN2D4-8 | \$27 | +\$11 | +\$11 |
|  | Controlled Receptacle for cutout tiles application in 2 3/4" frames | IN2D1-8C | \$32 | +\$11 | +\$11 |
| | | IN2D2-8C | \$32 | +\$11 | +\$11 |
| | | IN2D3-8C | \$32 | +\$11 | +\$11 |
| | | IN2D3U-8C | \$32 | +\$11 | +\$11 |
| | | IN2D4-8C | \$32 | +\$11 | +\$11 |
|  | Receptacle for use in Electrified Twin-Bin | IN3D1-UD-8 | \$27 | +\$11 | +\$11 |
| | | IN3D2-UD-8 | \$27 | +\$11 | +\$11 |
| | | IN3D3-UD-8 | \$27 | +\$11 | +\$11 |
| | | IN3D3U-UD-8 | \$27 | +\$11 | +\$11 |
| | | IN3D4-UD-8 | \$27 | +\$11 | +\$11 |

- The Hinged Cover is a plastic cover that acts as a hinged door to allow access to the cables if needed. Available in color options of black (default), white and gray
- Data cannot be installed directly back to back in a benching spine

NOTES







In order to get a total cost on products when upcharges are present take the list price of the product number and add the upcharge cost shown to the list price.

For example:





Product INHRC in Gray would be \$22 +\$11

| | Part number | Black/ base price | White | Gray |
|---|--------------|----------------------|-------|-------|
|  Hinged Cover for Tiles with Cutouts | INHRC | \$22 | +\$11 | +\$11 |

- Wire Management clips are white and attach by double sided tape which is included
- Wire Casing (INFWC) is 29" long and allows for electrical and data cables to be brought neatly from floor into a table – available in gray only, works with 28.5" worksurface heights
- Cable Management Tray (INCMTXX) is available in two lengths, painted Eco Black and includes mounting hardware
- Height Adjustable Cable Manager (INHACMT18) comes with a basic tray (see INCMT18) and 1" Diameter grey plastic wire sleeve that is single length piece with opening slit to accept cables
- 18"w Cable Manager Tray (INHACHCMT18) includes a black rectangular cable chain with an non-hinged tray
- Hinged Cable Manager Tray (INHACMTHINGE) includes black rectangular cable chain with a hinged tray

| | | Part number | Neutral paint/ base price | Accent paint |
|---|---|----------------------------------|------------------------------|-----------------|
|  | Wire Management Clip (pkg of 10) | INWMCLIP | \$30 | — |
|  | Wire Casing (Gray color) | INFWC | \$130 | — |
|  | Cable Management Tray | INCMT18 INCMT30 | \$36 \$47 | — — |
|  | Wire mesh cable tray (silver) | INWMTRAY | \$133 | — |
|  | Height Adjustable Cable Manager | INHACMT18 | \$89 | — |
|  | 18"w Cable Manager Tray For use with Electric Freestanding and Bench (illustrated) height adjustable applications | INHACHCMT18 | \$256 | +\$27 |
|  | Hinged Cable Manager Tray For use with Electric Freestanding and Bench (illustrated) height adjustable applications | INHACMTHINGE | \$532 | +\$56 |

- Power Modules mount to the back edge of a surface and are accessible by the user above the surface
- Power Modules plug into the duplexes
- The Clamp-On Power Module is available in a black or white finish. It has a 96" long power cord and LED surge protection indication. It attaches to 1" and 1 ¼" thick worksurfaces and the mount includes a device holder.
- The Clamp-On Power Module with Colored Components comes in many different configurations with receptacles, USB (1 type A and 1 type B) ports and availability lights. Power Modules come in black, white or gray and have colored options for the lid; Black, White, Teal, Red, Purple, Blue, Green, Gray. The availability light is user controlled and requires free software download.

| | Part number | List price |
|---|-----------------------|------------|
|  <p>Clamp-On Power Module 3 receptacles/1 dual USB port</p> | INPMOD-3P1U | \$173 |
|  <p>Clamp-On Power Module with Colored Components 2 Ports: 1 receptacle + 1 USB AC</p> | INBPMOD-1P1U | \$437 |
|  <p>Clamp-On Power Module with Colored Components 4 Ports: 2 receptacles + 1 USB AC + 1 open data port data not provided</p> | INBPMOD-2P1U1O | \$548 |
|  <p>Clamp-On Power Module with Colored Components 4 Ports: 2 receptacles + 1 USB AC + 1 availability light</p> | INBPMOD-2P1U1L | \$867 |

Bench
Worksurfaces
& Supports

inscape

work for tomorrow

Depth dimension is nominal. Depths are .325" less than stated to provide a gap between the worksurface and panel to facilitate wire management. Worksurfaces are specific to the worksurface support they are being installed on. Codes and dimensions are outlined in the following pages and Inscape Bench Application Guide showing which worksurface is to be specified with the End Gable, Open "H" Leg or Storage Support.

Depth dimensions listed on Height Adjustable surfaces are actual.

All worksurfaces default to 1.25" thick, Straight edge, Pencil Groove.

Grain direction on woodgrain Nuform worksurfaces is as denoted below.

NUFORM CLASSIC & NUFORM SELECT WORKSURFACES

The Nuform top is a thermo-formable polymer based sheet continuously bonded to a 1.25" thick MDF substrate. The polymer sheet is surface coated with a scratch resistant film. Colors are homogenous throughout the film thickness. Top and edge are one continuous surface with no edge seams. The underside of the top is finished in a low pressure melamine. Nuform tops have the option of a pencil groove running across the width of the worksurface as standard and depth for conference tables. Two price options are available - Nuform Classic and Nuform Select.

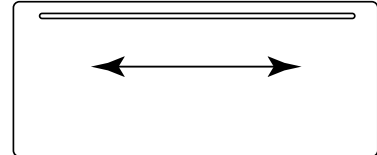

WORKSURFACE EXTENSION

The Worksurface Extension is a cantilevered worksurface which is situated perpendicular to the spine. This top is available in all the worksurface finishes of the standard worksurfaces (if woodgrain is chosen, pattern will run perpendicular to the main worksurfaces). This extension CANNOT be specified adjacent to the Height Adjustable Worksurfaces.

Edge Detail - Nuform Solid and Nuform Woodgrain

1 1/4" Straight Edge



1 1/4" Tapered Edge



Top and edge are one continuous surface with no edge seams.

Note that the tapered edge style is only available on the front or user edge of the worksurface.

LAMINATE WORKSURFACES

Plastic laminate is laminated to 1.25" thick particle-board. The underside of the worksurface is finished with a man-made, wood-fiber veneer backer. Worksurfaces specified with a plastic laminate finish include a 2mm edge banding in a coordinating color. Plastic laminate tops do not include a pencil groove.

Edge Detail - Plastic Laminate

Straight Edge



Load capacity for freestanding and panel mounted worksurfaces is 4.5lbs per linear inch.

ADJUSTABLE HEIGHT WORKSURFACES

Panel Mounted Electrical height adjustable worksurfaces are available for the Inscape Bench.

Electrical Height Adjustable Worksurfaces provide height adjustment ranging from 28.5" to 44.5" with a lift capacity and calibration of a recommended 195lbs (includes worksurface).

Worksurfaces structured on the height adjustable mechanism are 1" less in stated width in the price list, and are meant to be installed on center to the base allowing for a gap between adjacent surfaces to eliminate pinch points. The base mechanism of the worksurface is available in Silver only. See the Inscape Bench Application Guide for application notes and restrictions.

WORKSURFACE SUPPORT BRACKETS & ACCESSORIES

CANTILEVER BRACKET

Cantilever Bracket is fixed. Cantilever brackets support panel mounted worksurfaces on-module.

FLUSH BRACKETS

Flush Brackets are specified when two adjoining worksurfaces need to be held flush together. These brackets (INFB) come as a pair. Maximum span of overhang when supported with a flush bracket is 18" per side. These are not required for Height Adjustable worksurfaces.

SPACERS

Spacers are specified when storage is being specified within the bench. The appropriate height of storage to use within the bench is 22.5" id with FLAT GLIDE (Rectangular glides will not line up below the worksurface)

LEG ANCHOR BRACKET

A Bench 30"d Single Sided Electric Height Adjustable table must have rear glides at every height adjustable support bracket anchored to a concrete floor using the Leg Anchor Bracket and customer supplied 3/8"-16 x 2.25" (min.) concrete anchor studs. See installation manual for further details.

PEDESTAL BRACKETS

Pedestal Brackets are specified when a pedestal unit is being specified. This allows for docking of the storage pieces to the benching spine. End Location Bracket is to be specified when the pedestal is at the end of a run. The Middle Location Bracket is to be specified when a pedestal is situated below the bench within the bench.

**See Inscape Bench Application Guide.*

STORAGE DOCKING BRACKET

Storage Docking Bracket is used when lateral or bookcase units are specified perpendicular to the spine. This bracket docks the storage and worksurface to the spine.

**See Inscape Bench Application Guide.*

90° WORKSURFACE SUPPORT BRACKETS

90° worksurface to spine support brackets support a 90° worksurface off of a spine frame. These brackets are handed left or right and there is a double sided option. The handedness of the support bracket is from the user perspective. Brackets are available in all standard paint finishes.

SHARED WORKSURFACE SUPPORT BRACKETS

Shared worksurface support brackets are used to support either a 30"d or 36"d shared worksurface off of a spine frame(s) and are available in on module and mid module applications. See Inscape Bench Application Guide for application guidelines. Brackets are available in all standard paint finishes

ANGLED WOOD SUPPORT LEG

The angled wood fixed worksurface support leg supports the end of a 90° or shared worksurface that is not bracketed to the spine frames. The angled wood fixed worksurface support leg come in three finish options; Clear Oak (default), Black Oak and Clear Maple.

LATERAL TOPS

The Lateral Tops are available as 3/4" thick. These tops are to be specified atop the 22.5" id storage units, FLAT GLIDE only on storage. Tops are available in all standard Nuform finishes.

END SUPPORT

There are three main ways to support the Inscape Bench from an end support perspective. One option is a Full End Gable. This end gable unit spans the entire depth of the bench beneath the worksurfaces, which are specific to this support type. The End Gable is a fully kitted product code which includes trim, tiles, glides and structure. The trim can be painted in any standard paint color. Tiles are to be specified on the inside and outside of the end gable. Tiles on the interior consist of two separate tiles whereas the outside is one full tile. Woodgrain on the exterior tile will run vertical on the tile. The Full End Gable is only to be used with the Full Height Spine.

An alternative support is the Open End Leg which is available in the "H", "O" and "A" options. This open leg structure has the ability to span the entire depth of the bench as well as carry multiple storage/accessories components. These units may be found in the Accessories section and are specific to the Open End Leg. The Open End Leg is only to be used with the Partial Height Spine; unless the Height Adjustable version is being used.

Open O legs have the option to add a glazed insert to either the double or single sided applications. The inserts are glass and are available in clear, gray and etched 1 side finish options.

H Leg hole covers are available for use with H Legs that have been optioned for electric height adjustable worksurfaces as holes are visible. These covers are a small flat rectangular powder coated (any color) sheet steel part that has double sided tape attached and will ship 4 per pack.

Both support types have a mid-span support which matches the overall end aesthetic. These are available in 12", 18" and 24" d. Tiles on the Full Gable version are painted only.

When the Height Adjustable Worksurface is specified, either the Full End Gable or the Open End Leg which is specific to the Height Adjustable may be specified. See Inscape Bench Application Guide for more details.

SINGLE SIDED BENCH

Single Sided Bench may be specified to create single sided bench configuration. This application may only be used with a full height spine only. End Gable or Open End Legs are end support options. The legs include supports to tie into the spine or worksurface. Mid Supports, whether Full Gable or Open End Legs must be specified between two worksurfaces and tie into the spine on module. Use 18" mid support for 24" d worksurface and 24" mid support for 30" d worksurface. Benching worksurfaces are to be specified in the same way for single sided version of the bench. 36" d worksurfaces are not available in single sided version. When tiling full height tiles are to be specified. Nuform and laminate tiles cannot be used on single sided frames with electrical. When integrating height adjustable in a single sided application, specific end supports must be specified. The Single Sided Frame to Worksurface bracket must be specified to tie the worksurface into the spine.

Worksurfaces & Supports

Rectangular Tops
Middle Application

Bench



- Depth dimension is nominal. Depths are .325" less than stated to provide a gap between the worksurface and panel to facilitate wire management.
- Worksurfaces are to be specified with any Inscape Bench spine in a middle or non-end position
- Nuform and Laminate
- Straight & Tapered edge available on Nuform
- 84" and 96" worksurfaces require same support as two surfaces
- Stretcher bars are required to be specified with worksurfaces 54" and wider which do have any mid support
- Stretcher bars are also required for all 30" or deeper worksurfaces no matter the width including when mid cantilever is installed
- Be sure stretcher bars do not to interfere with support brackets, cable trays or other work tools

NOTES

In order to get a total cost on products when upcharges are present take the list price of the product number and add the upcharge cost shown to the list price.

For example:

Product INBW2442 in Nuform Select with Tapered Edge would be \$377 +\$42 +\$21

| | Part number | W | D | Nuform classic/ laminate/ base price | Nuform select | Nuform tapered | Grade 1 laminate | Grade 2 laminate |
|---|-----------------|-----|-----|--|------------------|-------------------|---------------------|---------------------|
|  <p>24" D Rectangular Top Middle Application</p> | INBW2442 | 42" | 24" | \$377 | +\$42 | +\$21 | +\$123 | +\$356 |
| | INBW2448 | 48" | 24" | \$432 | +\$47 | +\$23 | +\$140 | +\$362 |
| | INBW2454 | 54" | 24" | \$485 | +\$53 | +\$29 | +\$158 | +\$368 |
| | INBW2460 | 60" | 24" | \$538 | +\$57 | +\$31 | +\$173 | +\$382 |
| | INBW2472 | 72" | 24" | \$646 | +\$67 | +\$34 | +\$209 | +\$385 |
| | INBW2484 | 84" | 24" | \$755 | +\$79 | +\$37 | +\$243 | +\$394 |
| | INBW2496 | 96" | 24" | \$867 | +\$90 | +\$46 | +\$279 | +\$399 |
|  <p>30" D Rectangular Top Middle Application</p> | INBW3042 | 42" | 30" | \$472 | +\$51 | +\$27 | +\$153 | +\$404 |
| | INBW3048 | 48" | 30" | \$538 | +\$57 | +\$31 | +\$173 | +\$408 |
| | INBW3054 | 54" | 30" | \$604 | +\$63 | +\$32 | +\$196 | +\$413 |
| | INBW3060 | 60" | 30" | \$674 | +\$70 | +\$35 | +\$216 | +\$416 |
| | INBW3072 | 72" | 30" | \$807 | +\$85 | +\$42 | +\$259 | +\$426 |
| | INBW3084 | 84" | 30" | \$980 | +\$102 | +\$52 | +\$316 | +\$398 |
| | INBW3096 | 96" | 30" | \$1156 | +\$120 | +\$60 | +\$371 | +\$378 |

Worksurfaces & Supports

Rectangular Tops
Full End Gable Application

Bench



- Depth dimension is nominal. Depths are .325" less than stated to provide a gap between the worksurface and panel to facilitate wire management.
- Worksurfaces are to be specified with End Gable end support
- Nuform and Laminate
- Straight & Tapered edge available on Nuform
- 84" and 96" worksurfaces require same support as two surfaces
- Stretcher bars are required to be specified with worksurfaces 54" and wider which do have any mid support
- Stretcher bars are also required for all 30" or deeper worksurfaces no matter the width including when mid cantilever is installed
- Be sure stretcher bars do not to interfere with support brackets, cable trays or other work tools

NOTES

In order to get a total cost on products when upcharges are present take the list price of the product number and add the upcharge cost shown to the list price.

For example:

Product INBWE2442 in Nuform Select with Tapered Edge would be \$395 +\$44 +\$22

| | Part number | W | D | Nuform classic/ laminate/ base price | Nuform select | Nuform tapered | Grade 1 laminate | Grade 2 laminate |
|--|------------------|--------|-----|--|------------------|-------------------|---------------------|---------------------|
|  24" D Rectangular Top Full End Gable Application | INBWE2442 | 44.75" | 24" | \$395 | +\$44 | +\$22 | +\$128 | +\$373 |
| | INBWE2448 | 50.75" | 24" | \$452 | +\$50 | +\$25 | +\$145 | +\$380 |
| | INBWE2454 | 56.75" | 24" | \$509 | +\$56 | +\$30 | +\$165 | +\$386 |
| | INBWE2460 | 62.75" | 24" | \$565 | +\$59 | +\$32 | +\$182 | +\$401 |
| | INBWE2472 | 74.75" | 24" | \$680 | +\$71 | +\$35 | +\$219 | +\$403 |
| | INBWE2484 | 86.75" | 24" | \$794 | +\$85 | +\$39 | +\$255 | +\$413 |
| | INBWE2496 | 98.75" | 24" | \$910 | +\$93 | +\$48 | +\$292 | +\$420 |
|  30" D Rectangular Top Full End Gable Application | INBWE3042 | 44.75" | 30" | \$495 | +\$53 | +\$29 | +\$160 | +\$426 |
| | INBWE3048 | 50.75" | 30" | \$565 | +\$59 | +\$32 | +\$182 | +\$429 |
| | INBWE3054 | 56.75" | 30" | \$634 | +\$66 | +\$33 | +\$205 | +\$435 |
| | INBWE3060 | 62.75" | 30" | \$708 | +\$73 | +\$36 | +\$228 | +\$437 |
| | INBWE3072 | 74.75" | 30" | \$847 | +\$88 | +\$44 | +\$274 | +\$445 |
| | INBWE3084 | 86.75" | 30" | \$1030 | +\$106 | +\$54 | +\$331 | +\$417 |
| | INBWE3096 | 98.75" | 30" | \$1211 | +\$127 | +\$63 | +\$389 | +\$398 |

Worksurfaces & Supports

Rectangular Tops
Open End Leg Application

Bench



- Depth dimension is nominal. Depths are .325" less than stated to provide a gap between the worksurface and panel to facilitate wire management. Worksurfaces are to be specified with Open End Leg end support
- Nuform and Laminate
- Straight & Tapered edge available on Nuform
- 84" and 96" worksurfaces require same support as two surfaces
- Stretcher bars are required to be specified with worksurfaces 54" and wider which do have any mid support
- Stretcher bars are also required for all 30" or deeper worksurfaces no matter the width including when mid cantilever is installed
- Be sure stretcher bars do not to interfere with support brackets, cable trays or other work tools

NOTES

In order to get a total cost on products when upcharges are present take the list price of the product number and add the upcharge cost shown to the list price.

For example:

Product INBWO2442 in Nuform Select with Tapered Edge would be \$395 +\$44 +\$22

| | Part number | W | D | Nuform classic/ laminite/ base price | Nuform select | Nuform tapered | Grade 1 laminite | Grade 2 laminite |
|---|------------------|---------|-----|--|------------------|-------------------|---------------------|---------------------|
|  <p>24" D Rectangular Top Open End Leg Application</p> | INBWO2442 | 44.036" | 24" | \$395 | +\$44 | +\$22 | +\$128 | +\$373 |
| | INBWO2448 | 50.036" | 24" | \$452 | +\$50 | +\$25 | +\$145 | +\$380 |
| | INBWO2454 | 56.036" | 24" | \$509 | +\$56 | +\$30 | +\$165 | +\$386 |
| | INBWO2460 | 62.036" | 24" | \$565 | +\$59 | +\$32 | +\$182 | +\$401 |
| | INBWO2472 | 74.036" | 24" | \$680 | +\$71 | +\$35 | +\$219 | +\$403 |
| | INBWO2484 | 86.036" | 24" | \$794 | +\$85 | +\$39 | +\$255 | +\$413 |
| | INBWO2496 | 98.036" | 24" | \$910 | +\$93 | +\$48 | +\$292 | +\$420 |
|  <p>30" D Rectangular Top Open End Leg Application</p> | INBWO3042 | 44.036" | 30" | \$495 | +\$53 | +\$29 | +\$160 | +\$426 |
| | INBWO3048 | 50.036" | 30" | \$565 | +\$59 | +\$32 | +\$182 | +\$429 |
| | INBWO3054 | 56.036" | 30" | \$634 | +\$66 | +\$33 | +\$205 | +\$435 |
| | INBWO3060 | 62.036" | 30" | \$708 | +\$73 | +\$36 | +\$228 | +\$437 |
| | INBWO3072 | 74.036" | 30" | \$847 | +\$88 | +\$44 | +\$274 | +\$445 |
| | INBWO3084 | 86.036" | 30" | \$1030 | +\$106 | +\$54 | +\$331 | +\$417 |
| | INBWO3096 | 98.036" | 30" | \$1211 | +\$127 | +\$63 | +\$389 | +\$398 |

Worksurfaces & Supports

Rectangular Tops
End Storage Application

Bench



- Depth dimension is nominal. Depths are .325" less than stated to provide a gap between the worksurface and panel to facilitate wire management.
- Worksurfaces are to be specified when storage is being used as end support
- Nuform and Laminate
- Straight & Tapered edge available on Nuform
- 84" and 96" worksurfaces require same support as two surfaces
- Stretcher bars are required to be specified with worksurfaces 54" and wider which do have any mid support
- Stretcher bars are also required for all 30" or deeper worksurfaces no matter the width including when mid cantilever is installed
- Be sure stretcher bars do not to interfere with support brackets, cable trays or other work tools

NOTES

In order to get a total cost on products when upcharges are present take the list price of the product number and add the upcharge cost shown to the list price.

For example:

Product INBWF2442 in Nuform Select with Tapered Edge would be \$395 +\$44 +\$22

| | Part number | W | D | Nuform classic/ laminite/ base price | Nuform select | Nuform tapered | Grade 1 laminite | Grade 2 laminite |
|---|---|------------------|-------|--|------------------|-------------------|---------------------|---------------------|
|  24" D Rectangular Top End Storage Application | INBWF2442 | 42.3" | 24" | \$395 | +\$44 | +\$22 | +\$128 | +\$373 |
| | INBWF2448 | 48.3" | 24" | \$452 | +\$50 | +\$25 | +\$145 | +\$380 |
| | INBWF2454 | 54.3" | 24" | \$509 | +\$56 | +\$30 | +\$165 | +\$386 |
| | INBWF2460 | 60.3" | 24" | \$565 | +\$59 | +\$32 | +\$182 | +\$401 |
| | INBWF2472 | 72.3" | 24" | \$680 | +\$71 | +\$35 | +\$219 | +\$403 |
| | INBWF2484 | 84.3" | 24" | \$794 | +\$85 | +\$39 | +\$255 | +\$413 |
| | INBWF2496 | 96.3" | 24" | \$910 | +\$93 | +\$48 | +\$292 | +\$420 |
| |  30" D Rectangular Top End Storage Application | INBWF3042 | 42.3" | 30" | \$495 | +\$53 | +\$29 | +\$160 |
| INBWF3048 | | 48.3" | 30" | \$565 | +\$59 | +\$32 | +\$182 | +\$429 |
| INBWF3054 | | 54.3" | 30" | \$634 | +\$66 | +\$33 | +\$205 | +\$435 |
| INBWF3060 | | 60.3" | 30" | \$708 | +\$73 | +\$36 | +\$228 | +\$437 |
| INBWF3072 | | 72.3" | 30" | \$847 | +\$88 | +\$44 | +\$274 | +\$445 |
| INBWF3084 | | 84.3" | 30" | \$1030 | +\$106 | +\$54 | +\$331 | +\$417 |
| INBWF3096 | | 96.3" | 30" | \$1211 | +\$127 | +\$63 | +\$389 | +\$398 |



- Rectangular Curved worksurfaces have curved back corners and straight 90° front corners
- Stretcher bars are included with all perpendicular worksurfaces
- The curved rectangular perpendicular worksurface will overhang 4.5" from the spine end line
- The straight rectangular perpendicular worksurfaces will overhang .300" from the spine end line which will bring it flush with the end trim
- The shared worksurface is not available with a tapered edge and freestanding end support legs must be specified separately

NOTES

In order to get a total cost on products when upcharges are present take the list price of the product number and add the upcharge cost shown to the list price.

For example:

Product INBWCP2448 in Nuform Select with Tapered Edge would be \$432 +\$47 +\$23

| | Part number | W | D | Nuform classic/ laminate/ base price | Nuform select | Nuform tapered | Grade 1 laminate | Grade 2 laminate |
|---|---------------------|-----|-----|--|------------------|-------------------|---------------------|---------------------|
|  | INBWCP2448 | 48" | 24" | \$432 | +\$47 | +\$23 | +\$139 | +\$356 |
| | INBWCP2454 | 54" | 24" | \$485 | +\$53 | +\$29 | +\$161 | +\$368 |
| | INBWCP2460 | 60" | 24" | \$538 | +\$57 | +\$31 | +\$172 | +\$382 |
| Curved Rectangular 90° Worksurface with back curved corners | INBWCP3048 | 48" | 30" | \$538 | +\$57 | +\$31 | +\$172 | +\$408 |
| | INBWCP3054 | 54" | 30" | \$604 | +\$63 | +\$32 | +\$194 | +\$413 |
| | INBWCP3060 | 60" | 30" | \$674 | +\$70 | +\$35 | +\$214 | +\$416 |
|  | INBWSP2448 | 48" | 24" | \$432 | +\$47 | +\$23 | +\$139 | +\$362 |
| | INBWSP2454 | 54" | 24" | \$485 | +\$53 | +\$29 | +\$161 | +\$368 |
| | INBWSP2460 | 60" | 24" | \$538 | +\$57 | +\$31 | +\$172 | +\$382 |
| Straight Rectangular 90° Worksurface | INBWSP3048 | 48" | 30" | \$538 | +\$57 | +\$31 | +\$172 | +\$408 |
| | INBWSP3054 | 54" | 30" | \$604 | +\$63 | +\$32 | +\$194 | +\$413 |
| | INBWSP3060 | 60" | 30" | \$674 | +\$70 | +\$35 | +\$214 | +\$416 |
|  | INBWSHSP3048 | 48" | 30" | \$538 | +\$57 | — | +\$172 | +\$408 |
| | INBWSHSP3054 | 54" | 30" | \$604 | +\$63 | — | +\$194 | +\$413 |
| | INBWSHSP3060 | 60" | 30" | \$674 | +\$70 | — | +\$214 | +\$416 |
| Straight Rectangular Shared Worksurface | INBWSHSP3648 | 48" | 36" | \$621 | +\$66 | — | +\$205 | +\$486 |
| | INBWSHSP3654 | 54" | 36" | \$699 | +\$73 | — | +\$225 | +\$492 |
| | INBWSHSP3660 | 60" | 36" | \$783 | +\$84 | — | +\$251 | +\$521 |

Worksurfaces & Supports

120° Worksurface
Middle Application

Bench

- Depth dimension is nominal. Depths are .325" less than stated to provide a gap between the worksurface and panel to facilitate wire management.
- Worksurfaces are to be specified with any Inscape Bench spine in a middle or non-end position
- 24"d worksurfaces have a front dimension of 38"
- 30"d worksurfaces have a front dimension of 32"
- Specific worksurfaces must be used in specific applications based on location and end support
- Nuform* and Laminate
- *All 23"D 120° surfaces that are 54"W & 60"W are NOT available in Nuform
- *All 29"W 120° surfaces that are 48"W, 54"W & 60"W are NOT available in Nuform
- Straight & Tapered edge available on Nuform
- Stretcher bars are required to be specified with worksurfaces 54" and wider which do have any mid support

- Stretcher bars are also required for all 30" or deeper worksurfaces no matter the width including when mid cantilever is installed
- Be sure stretcher bars do not to interfere with support brackets, cable trays or other work tools

NOTES

In order to get a total cost on products when upcharges are present take the list price of the product number and add the upcharge cost shown to the list price.

For example:

Product INBWVM363624-S in Grade 1 laminate would be \$539 +\$174

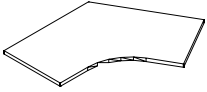
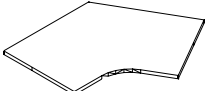
| | Part number | W | D | Nuform classic/ laminate/ base price | Nuform select | Nuform tapered | Grade 1 laminate | Grade 2 laminate |
|--|---------------------|-----|-----|--|------------------|-------------------|---------------------|---------------------|
|  <p>24" D 120° Worksurface Middle Application</p> | INBWVM363624 | 36" | 23" | \$539 | +\$54 | +\$31 | +\$174 | +\$605 |
| | INBWVM424224 | 42" | 23" | \$767 | +\$79 | +\$43 | +\$247 | +\$680 |
| | INBWVM484824 | 48" | 23" | \$939 | +\$97 | +\$48 | +\$302 | +\$801 |
| | INBWVM545424 | 54" | 23" | \$1037 | — | — | +\$333 | — |
| | INBWVM606024 | 60" | 23" | \$1306 | — | — | +\$420 | — |
|  <p>30" D 120° Worksurface Middle Application</p> | INBWVM363630 | 36" | 29" | \$666 | +\$67 | +\$34 | +\$214 | +\$638 |
| | INBWVM424230 | 42" | 29" | \$806 | +\$84 | +\$43 | +\$259 | +\$771 |
| | INBWVM484830 | 48" | 29" | \$971 | — | — | +\$313 | — |
| | INBWVM545430 | 54" | 29" | \$1134 | — | — | +\$364 | — |
| | INBWVM606030 | 60" | 29" | \$1422 | — | — | +\$456 | — |

Worksurfaces & Supports

120° Worksurface
Full End Gable Application

- Depth dimension is nominal. Depths are .325" less than stated to provide a gap between the worksurface and panel to facilitate wire management.
- Worksurfaces are to be specified when Full End Gable are used as end support
- 24" D worksurfaces have a front dimension of 38"
- 30" D worksurfaces have a front dimension of 32"
- Specific worksurfaces must be used in specific applications based on location and end support
- Nuform* and Laminate
- *All 23"D 120° surfaces that are 54"W & 60"W are NOT available in Nuform
- *All 29"W 120° surfaces that are 48"W, 54"W & 60"W are NOT available in Nuform
- Straight & Tapered edge available on Nuform
- Stretcher bars are required to be specified with worksurfaces 54" and wider which do have any mid support

- Stretcher bars are also required for all 30" or deeper worksurfaces no matter the width including when mid cantilever is installed
- Be sure stretcher bars do not to interfere with support brackets, cable trays or other work tools

NOTES

In order to get a total cost on products when upcharges are present take the list price of the product number and add the upcharge cost shown to the list price.

For example:

Product INBWWLHE363624-S in Grade 1 laminate would be \$566 +\$182

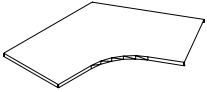
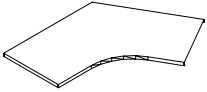
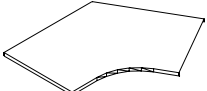
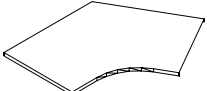
| | Part number | W | D | Nuform classic/ laminate/ base price | Nuform select | Nuform tapered | Grade 1 laminate | Grade 2 laminate |
|--|-----------------------|-----|-----|--|------------------|----------------|---------------------|---------------------|
|  <p>24" D 120° Worksurface Full End Gable Application</p> | INBWWLHE363624 | 36" | 23" | \$566 | +\$58 | +\$31 | +\$182 | +\$646 |
| | INBWWLHE424224 | 42" | 23" | \$806 | +\$84 | +\$43 | +\$259 | +\$722 |
| | INBWWLHE484824 | 48" | 23" | \$984 | +\$99 | +\$51 | +\$317 | +\$843 |
| | INBWWLHE545424 | 54" | 23" | \$1090 | — | — | +\$350 | — |
| | INBWWLHE606024 | 60" | 23" | \$1372 | — | — | +\$441 | — |
| | left-handed | | | | | | | |
|  | INBWWRHE363624 | 36" | 23" | \$566 | +\$58 | +\$31 | +\$182 | +\$646 |
| | INBWWRHE424224 | 42" | 23" | \$806 | +\$84 | +\$43 | +\$259 | +\$722 |
| | INBWWRHE484824 | 48" | 23" | \$984 | +\$99 | +\$51 | +\$317 | +\$843 |
| | INBWWRHE545424 | 54" | 23" | \$1090 | — | — | +\$350 | — |
| | INBWWRHE606024 | 60" | 23" | \$1372 | — | — | +\$441 | — |
| | right-handed | | | | | | | |
|  <p>30" D 120° Worksurface Full End Gable Application</p> | INBWWLHE363630 | 36" | 29" | \$698 | +\$71 | +\$36 | +\$225 | +\$680 |
| | INBWWLHE424230 | 42" | 29" | \$846 | +\$87 | +\$45 | +\$273 | +\$815 |
| | INBWWLHE484830 | 48" | 29" | \$1019 | — | — | +\$328 | — |
| | INBWWLHE545430 | 54" | 29" | \$1193 | — | — | +\$383 | — |
| | INBWWLHE606030 | 60" | 29" | \$1494 | — | — | +\$479 | — |
| | left-handed | | | | | | | |
|  | INBWWRHE363630 | 36" | 29" | \$698 | +\$71 | +\$36 | +\$225 | +\$680 |
| | INBWWRHE424230 | 42" | 29" | \$846 | +\$87 | +\$45 | +\$273 | +\$815 |
| | INBWWRHE484830 | 48" | 29" | \$1019 | — | — | +\$328 | — |
| | INBWWRHE545430 | 54" | 29" | \$1193 | — | — | +\$383 | — |
| | INBWWRHE606030 | 60" | 29" | \$1494 | — | — | +\$479 | — |
| | right-handed | | | | | | | |

Worksurfaces & Supports

120° Worksurface
Full End Gable Application

- Depth dimension is nominal. Depths are .325" less than stated to provide a gap between the worksurface and panel to facilitate wire management.
- Worksurfaces are to be specified when Full End Gable are used as end support
- 24" D worksurfaces have a front dimension of 38"
- 30" D worksurfaces have a front dimension of 32"
- Specific worksurfaces must be used in specific applications based on location and end support
- Nuform* and Laminate
- *All 23"D 120° surfaces that are 54"W & 60"W are NOT available in Nuform
- *All 29"W 120° surfaces that are 48"W, 54"W & 60"W are NOT available in Nuform
- Straight & Tapered edge available on Nuform
- Stretcher bars are required to be specified with worksurfaces 54" and wider which do have any mid support
- Stretcher bars are also required for all 30" or deeper worksurfaces no matter the width including when mid cantilever is installed
- Be sure stretcher bars do not to interfere with support brackets, cable trays or other work tools

NOTES

In order to get a total cost on products when upcharges are present take the list price of the product number and add the upcharge cost shown to the list price.

For example:

Product INBWVDE363624-S in Grade 1 laminate would be \$592 +\$192

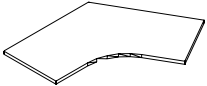

| | Part number | W | D | Nuform classic/ laminate/ base price | Nuform select | Nuform tapered | Grade 1 laminate | Grade 2 laminate |
|---|----------------------|-----|-----|--|------------------|-------------------|---------------------|---------------------|
| 24" D 120° Worksurface Double Full End Gable Application | INBWVDE363624 | 36" | 23" | \$592 | +\$60 | +\$32 | +\$192 | +\$686 |
| | INBWVDE424224 | 42" | 23" | \$844 | +\$87 | +\$44 | +\$273 | +\$762 |
| | INBWVDE484824 | 48" | 23" | \$1032 | +\$103 | +\$53 | +\$331 | +\$885 |
| | INBWVDE545424 | 54" | 23" | \$1140 | — | — | +\$367 | — |
| | INBWVDE606024 | 60" | 23" | \$1438 | — | — | +\$463 | — |



| | | | | | | | | |
|---|----------------------|-----|-----|--------|-------|-------|--------|--------|
| 30" D 120° Worksurface Double Full End Gable Application | INBWVDE363630 | 36" | 29" | \$733 | +\$73 | +\$37 | +\$237 | +\$722 |
| | INBWVDE424230 | 42" | 29" | \$886 | +\$90 | +\$46 | +\$286 | +\$859 |
| | INBWVDE484830 | 48" | 29" | \$1066 | — | — | +\$343 | — |
| | INBWVDE545430 | 54" | 29" | \$1248 | — | — | +\$401 | — |
| | INBWVDE606030 | 60" | 29" | \$1565 | — | — | +\$503 | — |

Worksurfaces & Supports

120° Worksurface
Open End Leg Application



- Depth dimension is nominal. Depths are .325" less than stated to provide a gap between the worksurface and panel to facilitate wire management.
- Worksurfaces are to be specified when Open End Legs are used as end support
- 24" D worksurfaces have a front dimension of 38"
- 30" D worksurfaces have a front dimension of 32"
- Specific worksurfaces must be used in specific applications based on location and end support
- Nuform* and Laminate
- *All 23"D 120° surfaces that are 54"W & 60"W are NOT available in Nuform
- *All 29"W 120° surfaces that are 48"W, 54"W & 60"W are NOT available in Nuform
- Straight & Tapered edge available on Nuform
- Stretcher bars are required to be specified with worksurfaces 54" and wider which do have any mid support
- Stretcher bars are also required for all 30" or deeper worksurfaces no matter the width including when mid cantilever is installed
- Be sure stretcher bars do not to interfere with support brackets, cable trays or other work tools

NOTES

In order to get a total cost on products when upcharges are present take the list price of the product number and add the upcharge cost shown to the list price.

For example:

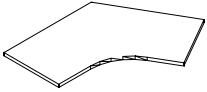
Product INBWWLHO363624-S in Grade 1 laminate would be \$566 +\$182

| | Part number | W | D | Nuform classic/ laminate/ base price | Nuform select | Nuform tapered | Grade 1 laminate | Grade 2 laminate |
|--|-----------------------|-----|--------|--|------------------|-------------------|---------------------|---------------------|
|  <p>24" D 120° Worksurface Open End Leg Application</p> | INBWWLHO363624 | 36" | 23" | \$566 | +\$58 | +\$30 | +\$182 | +\$646 |
| | INBWWLHO424224 | 42" | 23" | \$806 | +\$84 | +\$43 | +\$259 | +\$722 |
| | INBWWLHO484824 | 48" | 23" | \$984 | +\$99 | +\$51 | +\$317 | +\$843 |
| | INBWWLHO545424 | 54" | 23" | \$1090 | — | — | +\$350 | — |
| | INBWWLHO606024 | 60" | 23" | \$1372 | — | — | +\$441 | — |
| | left-handed | | | | | | | |
| | INBWWRHO363624 | 36" | 23" | \$566 | +\$58 | +\$31 | +\$182 | +\$646 |
| | INBWWRHO424224 | 42" | 23" | \$806 | +\$84 | +\$43 | +\$259 | +\$722 |
| | INBWWRHO484824 | 48" | 23" | \$984 | +\$99 | +\$51 | +\$317 | +\$843 |
| | INBWWRHO545424 | 54" | 23" | \$1090 | — | — | +\$350 | — |
| INBWWRHO606024 | 60" | 23" | \$1372 | — | — | +\$441 | — | |
| right-handed | | | | | | | | |
|  <p>30" D 120° Worksurface Open End Leg Application</p> | INBWWLHO363630 | 36" | 29" | \$698 | +\$71 | +\$36 | +\$225 | +\$680 |
| | INBWWLHO424230 | 42" | 29" | \$846 | +\$87 | +\$45 | +\$273 | +\$815 |
| | INBWWLHO484830 | 48" | 29" | \$1019 | — | — | +\$328 | — |
| | INBWWLHO545430 | 54" | 29" | \$1193 | — | — | +\$383 | — |
| | INBWWLHO606030 | 60" | 29" | \$1494 | — | — | +\$479 | — |
| | left-handed | | | | | | | |
| | INBWWRHO363630 | 36" | 29" | \$698 | +\$71 | +\$36 | +\$225 | +\$680 |
| | INBWWRHO424230 | 42" | 29" | \$846 | +\$87 | +\$45 | +\$273 | +\$815 |
| | INBWWRHO484830 | 48" | 29" | \$1019 | — | — | +\$328 | — |
| | INBWWRHO545430 | 54" | 29" | \$1193 | — | — | +\$383 | — |
| INBWWRHO606030 | 60" | 29" | \$1494 | — | — | +\$479 | — | |
| right-handed | | | | | | | | |

Worksurfaces & Supports

120° Worksurface
Open End Leg Application

Bench



- Depth dimension is nominal. Depths are .325" less than stated to provide a gap between the worksurface and panel to facilitate wire management.
- Worksurfaces are to be specified when Open End Legs are used as end support
- 24" D worksurfaces have a front dimension of 38"
- 30" D worksurfaces have a front dimension of 32"
- Specific worksurfaces must be used in specific applications based on location and end support
- Nuform* and Laminate
- *All 23"D 120° surfaces that are 54"W & 60"W are NOT available in Nuform
- *All 29"W 120° surfaces that are 48"W, 54"W & 60"W are NOT available in Nuform
- Straight & Tapered edge available on Nuform
- Stretcher bars are required to be specified with worksurfaces 54" and wider which do have any mid support
- Stretcher bars are also required for all 30" or deeper worksurfaces no matter the width including when mid cantilever is installed
- Be sure stretcher bars do not to interfere with support brackets, cable trays or other work tools

NOTES

In order to get a total cost on products when upcharges are present take the list price of the product number and add the upcharge cost shown to the list price.

For example:

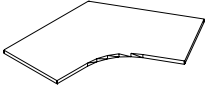
Product INBWVDO363624-S in Grade 1 laminate would be \$566 +\$182

| | Part number | W | D | Nuform classic/ laminate/ base price | Nuform select | Nuform tapered | Grade 1 laminate | Grade 2 laminate |
|---|----------------------|-----|-----|--|------------------|-------------------|---------------------|---------------------|
|  <p>24" D 120° Worksurface Double Open End Leg Application</p> | INBWVDO363624 | 36" | 23" | \$592 | +\$60 | +\$32 | +\$192 | +\$686 |
| | INBWVDO424224 | 42" | 23" | \$844 | +\$87 | +\$44 | +\$273 | +\$762 |
| | INBWVDO484824 | 48" | 23" | \$1032 | +\$103 | +\$53 | +\$331 | +\$885 |
| | INBWVDO545424 | 54" | 23" | \$1140 | — | — | +\$367 | — |
| | INBWVDO606024 | 60" | 23" | \$1438 | — | — | +\$463 | — |
|  <p>30" D 120° Worksurface Double Open End Leg Application</p> | INBWVDO363630 | 36" | 29" | \$733 | +\$73 | +\$37 | +\$237 | +\$722 |
| | INBWVDO424230 | 42" | 29" | \$886 | +\$90 | +\$46 | +\$286 | +\$859 |
| | INBWVDO484830 | 48" | 29" | \$1066 | — | — | +\$343 | — |
| | INBWVDO545430 | 54" | 29" | \$1248 | — | — | +\$401 | — |
| | INBWVDO606030 | 60" | 29" | \$1565 | — | — | +\$503 | — |

Worksurfaces & Supports

Height Adjustable Worksurface
Electric

Bench

- Specific worksurfaces must be used in specific applications based on location and end support
- This electric height adjustable table with two motors has a lift capacity of 195lbs (includes worksurface)
- Height adjustment is 28.5" to 44.5"; a total range of 16"
- Base available in Steel Wool, White Velvet or Kettle Black
- Nuform and Laminate
- Straight & Tapered edge available on Nuform
- End units are ½" shorter in length and Middle units are ½" shorter on each end eliminating potential pinch points
- Can be installed on a Full Height or Partial Height Spine with Full End Support. No mid support is required
- Only to be installed on Full Height Panel option - with either full height end gable or open end leg
- See Inscape Bench Application Guide for more details
- Stretcher bars not required for Height Adjustable worksurfaces

HANDSET OPTIONS

Included at no additional cost:

1. Handset with Up Down Buttons

OR

2. Intuitive Paddle

Optional with upcharge:

3. Handset with Up Down Buttons + Memory Display (+\$92)

OR

4. Intuitive Paddle with Bluetooth + Memory Display (+\$92)

NOTES

In order to get a total cost on products when upcharges are present take the list price of the product number and add the upcharge cost shown to the list price.

For example:

Product INBELAKM2448 in Grade 1 laminate would be \$3869 +\$140

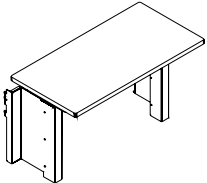
| | Part number | W | D | Nuform classic/ laminate/ base price | Nuform select | Nuform tapered | Grade 1 laminate | Grade 2 laminate | Accent paint |
|--|---------------------|-----|---------|--|------------------|-------------------|---------------------|---------------------|-----------------|
|  | INBELAKM2448 | 47" | 23.675" | \$3869 | +\$47 | +\$23 | +\$140 | +\$326 | +\$389 |
| | INBELAKM2454 | 53" | 23.675" | \$3915 | +\$53 | +\$29 | +\$158 | +\$330 | +\$395 |
| | INBELAKM2460 | 59" | 23.675" | \$3963 | +\$57 | +\$31 | +\$173 | +\$343 | +\$399 |
| | INBELAKM2472 | 71" | 23.675" | \$4062 | +\$67 | +\$34 | +\$209 | +\$369 | +\$410 |

24" D Electric
Height Adjustable
Worksurface
Middle Application

| | | | | | | | | | |
|---|---------------------|-----|---------|--------|-------|-------|--------|--------|--------|
|  | INBELAKM3048 | 47" | 29.675" | \$3963 | +\$51 | +\$23 | +\$173 | +\$367 | +\$399 |
| | INBELAKM3054 | 53" | 29.675" | \$4022 | +\$63 | +\$29 | +\$196 | +\$371 | +\$404 |
| | INBELAKM3060 | 59" | 29.675" | \$4086 | +\$71 | +\$31 | +\$216 | +\$374 | +\$412 |
| | INBELAKM3072 | 71" | 29.675" | \$4206 | +\$85 | +\$34 | +\$259 | +\$383 | +\$424 |

30" D Electric
Height Adjustable
Worksurface
Middle Application

| | | | | | | | | | |
|---|---------------------|--------|---------|--------|-------|-------|--------|--------|--------|
|  | INBELAKE2448 | 50.25" | 23.675" | \$4062 | +\$47 | +\$23 | +\$145 | +\$342 | +\$410 |
| | INBELAKE2454 | 56.25" | 23.675" | \$4113 | +\$53 | +\$29 | +\$165 | +\$347 | +\$414 |
| | INBELAKE2460 | 62.25" | 23.675" | \$4162 | +\$57 | +\$31 | +\$182 | +\$361 | +\$418 |
| | INBELAKE2472 | 74.75" | 23.675" | \$4262 | +\$67 | +\$34 | +\$219 | +\$388 | +\$429 |

24" D Electric Height
Adjustable Worksurface
Full End Gable Application

Worksurfaces & Supports

Height Adjustable Worksurface
Electric

Bench

- Specific worksurfaces must be used in specific applications based on location and end support
- This electric height adjustable table with two motors has a lift capacity of 195lbs (includes worksurface)
- Height adjustment is 28.5" to 44.5"; a total range of 16"
- Base available in Steel Wool, White Velvet or Kettle Black
- Nuform and Laminate
- Straight & Tapered edge available on Nuform
- End units are ½" shorter in length and Middle units are ½" shorter on each end eliminating potential pinch points
- Can be installed on a Full Height to Partial Height Spine with Full able End support. No mid support is required
- Only to be installed on Full Height Panel option - with either full height end gable or open end leg
- See Inscape Bench Application Guide for more details
- Stretcher bars not required for Height Adjustable worksurfaces

HANDSET OPTIONS

Included at no additional cost:

1. Handset with Up Down Buttons

OR

2. Intuitive Paddle

Optional with upcharge:

3. Handset with Up Down Buttons + Memory Display (+\$92)

OR

4. Intuitive Paddle with Bluetooth + Memory Display (+\$92)

NOTES

In order to get a total cost on products when upcharges are present take the list price of the product number and add the upcharge cost shown to the list price.

For example:

Product INBELAKE3048 in Grade 1 laminate would be \$4162 +\$182

| | Part number | W | D | Nuform classic/ laminate/ base price | Nuform select | Nuform tapered | Grade 1 laminate | Grade 2 laminate | Accent paint |
|--|---------------------|--------|---------|--|------------------|-------------------|---------------------|---------------------|-----------------|
|  | INBELAKE3048 | 50.25" | 29.675" | \$4162 | +\$51 | +\$23 | +\$182 | +\$386 | +\$418 |
| | INBELAKE3054 | 56.25" | 29.675" | \$4224 | +\$63 | +\$29 | +\$205 | +\$391 | +\$426 |
| | INBELAKE3060 | 62.25" | 29.675" | \$4290 | +\$70 | +\$31 | +\$228 | +\$394 | +\$431 |
| | INBELAKE3072 | 74.75" | 29.675" | \$4416 | +\$85 | +\$34 | +\$274 | +\$402 | +\$443 |

30" D Electric Height
Adjustable Worksurface
Full End Gable Application



| | | | | | | | | | |
|---|---------------------|---------|---------|--------|-------|-------|--------|--------|--------|
|  | INBELAKO2448 | 50.536" | 23.675" | \$4062 | +\$47 | +\$23 | +\$145 | +\$342 | +\$410 |
| | INBELAKO2454 | 56.536" | 23.675" | \$4113 | +\$53 | +\$29 | +\$165 | +\$347 | +\$414 |
| | INBELAKO2460 | 62.536" | 23.675" | \$4162 | +\$57 | +\$31 | +\$182 | +\$361 | +\$418 |
| | INBELAKO2472 | 74.536" | 23.675" | \$4262 | +\$67 | +\$34 | +\$219 | +\$388 | +\$429 |

24" D Electric Height
Adjustable Worksurface
Open End Leg Application



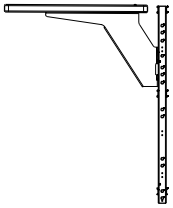
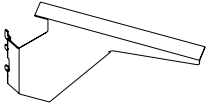

| | | | | | | | | | |
|---|---------------------|---------|---------|--------|-------|-------|--------|--------|--------|
|  | INBELAKO3048 | 50.536" | 29.675" | \$4162 | +\$51 | +\$23 | +\$182 | +\$386 | +\$418 |
| | INBELAKO3054 | 56.536" | 29.675" | \$4224 | +\$63 | +\$29 | +\$205 | +\$391 | +\$426 |
| | INBELAKO3060 | 62.536" | 29.675" | \$4290 | +\$70 | +\$31 | +\$228 | +\$394 | +\$431 |
| | INBELAKO3072 | 74.536" | 29.675" | \$4416 | +\$85 | +\$34 | +\$274 | +\$402 | +\$443 |

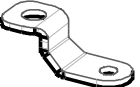
30" D Electric Height
Adjustable Worksurface
Open End Leg Application

- Cantilever brackets support worksurfaces at mid-span
- Spacers are to be specified in conjunction with 22.5" id cases and 3/8" thick tops to support worksurfaces
- A Bench 30"d Single Sided Electric Height Adjustable table must have rear glides at every height adjustable support bracket anchored to a concrete floor using the Leg Anchor Bracket and customer supplied 3/8"-16 x 2.25" (min.) concrete anchor studs. See installation manual for further details.

| | | Part number | H | Eco black/ base price | Neutral paint | Accent paint |
|---|--|------------------------------------|------|-----------------------------|------------------|-----------------|
|  | Cantilever Bracket Fixed Height Handed | INBRHCB right-handed | — | \$92 | +\$7 | +\$12 |
| | | INBLHCB left-handed | — | \$92 | +\$7 | +\$12 |
|  | 120° Cantilever Bracket | INB120CB | — | \$79 | +\$13 | +\$11 |
|  | Spacers (pkg.4) | WSPACERLAT For Laterals | 1.3" | \$69 | — | +\$10 |
| | | WSPACERPED For Pedestals | 1.3" | \$36 | — | +\$7 |
| | | Part number | H | Neutral paint base price | Accent paint | |
|  | Leg Anchor Bracket | INBLABKT | — | \$59 | +\$8 | |

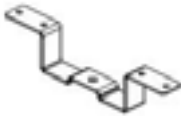



- Pedestal brackets dock pedestal cases to the benching spine. See Inscape Bench Application Guide
- Frame to Worksurface is to be specified in certain configurations where storage is the anchor. See Inscape Bench Application Guide
- Stretcher bars are required to be specified with worksurfaces 54" and wider which do have any mid support
- Stretcher bars are also required for all 30" or deeper worksurfaces no matter the width including when mid cantilever is installed
- Be sure stretcher bars do not to interfere with support brackets, cable trays or other work tools
- Stretcher bars not required for Height Adjustable worksurfaces
- Stretcher bars are 1 1/2" H

| | | Part number | H | Eco black/ base price | Neutral paint | Accent paint |
|---|---|---|-----|--------------------------|------------------|-----------------|
|  | Pedestal Bracket, End Location | INBPEDLHBREDE left-handed (illustrated) | — | \$92 | — | +\$12 |
| | | INBPEDRHBREDE right-handed | — | \$92 | — | +\$12 |
|  | Pedestal Bracket, Middle Location | INBPEDLHBRMDE left-handed (illustrated) | — | \$92 | — | +\$12 |
| | | INBPEDRHBRMDE right-handed | — | \$92 | — | +\$12 |
|  | Frame to Worksurface Connection Bracket | INBSPWSBRKT Double Sided | — | \$91 | — | +\$12 |
| | | INBSPWBRKTSS Single Sided | — | \$92 | — | +\$12 |
|  | Worksurface Stretcher Bar For use with worksurfaces 54" and wider | INSBK54 For use with 54" surface | 44" | — | \$77 | — |
| | | INSBK60 For use with 60" surface | 50" | — | \$114 | — |
| | | INSBK72 For use with 72" surface | 62" | — | \$135 | — |
| | | INSBK84 For use with 84" surface | 74" | — | \$162 | — |
| | | INSBK96 For use with 96" surface | 86" | — | \$183 | — |

Worksurfaces & Supports

Worksurfaces Supports
90° Application

- 90° worksurface to spine support brackets support a 90° worksurface at the end of a spine frame at 28.5" H. These brackets are handed left or right and there is a double sided option
- The handedness of the support bracket is determined from the user perspective (i.e. a left handed bracket would install on the left hand side of the user)
- Shared worksurface support brackets are used to support either a 30" D or 36" D shared worksurface off of a spine frame(s) and are available in on module and mid module applications. See Inscape Bench Application Guide for application guidelines
- Brackets are available in all of Inscape's standard paint colors



| | | Part number | H | Neutral paint/ base price | Accent paint | |
|--|--|-----------------------------------|---|------------------------------|-----------------|--|
|  Left hand bracket | 90° Worksurface to Spine Support Bracket | INBWSBPERPLH | — | \$172 | +\$20 | |
| | | Single left hand bracket | | | | |
| | | INBWSBPERPRH | — | \$172 | +\$20 | |
| Single right hand bracket | | | | | | |
|  Back to back bracket | | INBWSBPERPBB | — | \$255 | +\$27 | |
| | | Double sided back-to-back bracket | | | | |
|  On module | Shared Worksurface Support Bracket | INWHSBRKT-OM | — | \$126 | +\$16 | |
| | | For on module applications | | | | |
|  Mid module | | INWHSBRKT-OFF | — | \$240 | +\$26 | |
| | | For mid module applications | | | | |

Worksurfaces & Supports

Worksurfaces Supports
90° Application

Bench

- Height Adjustable Foot Docking Bracket must be specified when spine is freestanding with height adjustable tables
- Height Adjustable Foot Docking Bracket for use with no accessories can only be used in 90° applications
- Height Adjustable Foot Docking Bracket for use with accessories can only be used in 90° applications
- The angled wood fixed worksurface support leg supports the end of a 90° or shared worksurface that is not bracketed to the spine frames
- Wood support legs are available in Clear Oak (default), Black Oak and Clear Maple finishes
- ¼" Tapcon Masonry Screws are NOT included with the Anchor Bracket

| | | Part number | H | Neutral paint/ base price | Accent paint |
|---|--|---|---|------------------------------|-----------------|
|  With Accessories | Height Adjustable Foot Docking Bracket | INBHAFDBRKTACCY | — | \$24 | +\$6 |
| | | For Bench Spine with Accessories Attached | | | |
|  No Accessories | Height Adjustable Foot Docking Bracket | INBHAFDBRKTACCN | — | \$24 | +\$6 |
| | | For Bench Spine with No Accessories | | | |

| | | Part number | H | List price |
|---|---|----------------------|-------|------------|
|  | Angled Wood Fixed Worksurface Support Leg | TANGCONPL28.5 | 27 ¾" | \$504 |
| | | Single leg | | |

Worksurfaces & Supports

Worksurfaces Supports
Parallel Application

Bench

- Freestanding Height Adjustable Foot Docking Bracket can be specified to dock the non-mobile Height Adjustable Tables to a T Foot in parallel applications

| | | Part number | H | Neutral paint/ base price | Accent paint |
|---|---|------------------------|---|------------------------------|-----------------|
|  | Freestanding Height Adjustable Foot Docking Bracket for parallel applications | INBHAFDBRKTPARL | — | \$29 | — |



- 3/8" thick tops are available in Nuform (straight edge) and Laminate
- Tops are specified on 22.5" id cases along with spacers to support surfaces at 28.5" H
- Pedestal top depths are sized so that the tops line up flush with the front of the pedestals and go all the way to the front of the tile behind, covering the docking bracket space
- Tops are not available with plywood edge band

NOTES

In order to get a total cost on products when upcharges are present take the list price of the product number and add the upcharge cost shown to the list price.

For example:

Product INSWTOP1836 in Grade 1 laminate would be \$238 +\$77

| | Part number | W | D | Nuform classic/ laminate/ base price | Nuform select | Grade 1 laminate |
|--|--|-----|---------|--|------------------|---------------------|
|  22" D x 3/8" T Pedestal Top | INBPEDTOP1522 For Storage with Handles | 15" | 23 5/8" | \$111 | +\$17 | +\$36 |
| | INBPEDTOP1522.7 For 9900 series | 15" | 24 1/3" | \$124 | +\$15 | +\$42 |
|  28" D x 3/8" T Pedestal Top | INBPEDTOP1528 For Storage with Handles | 15" | 29 5/8" | \$138 | +\$17 | +\$47 |
| | INBPEDTOP1528.7 For 9900 series | 15" | 30 1/3" | \$145 | +\$25 | +\$49 |
|  18" D x 3/8" T Lateral Top | INSWTOP1830 | 30" | 18" | \$221 | +\$15 | +\$72 |
| | INSWTOP1836 | 36" | 18" | \$238 | +\$35 | +\$77 |
| | INSWTOP1842 | 42" | 18" | \$267 | +\$45 | +\$88 |
| | INSWTOP1848 | 48" | 18" | \$295 | +\$52 | +\$97 |
| | INSWTOP1854 | 54" | 18" | \$328 | +\$53 | +\$106 |
| | INSWTOP1860 | 60" | 18" | \$507 | +\$56 | +\$165 |
| | INSWTOP1872 | 72" | 18" | \$605 | +\$63 | +\$196 |
| INSWTOP1878 | 78" | 18" | \$704 | +\$73 | +\$227 | |

Worksurfaces & Supports

Worksurfaces Supports
Full Gable

Bench

- When specifying a Full Gable End Supports, choose the base, then option of inside and outside tiles and finally choose the worksurface support option
- Full Gable End Supports have options of Nuform, laminate, paint or no tile
- Full Gable Mid Support is available in paint and no tile
- Option "NO" interior tile when a Trading Desk unit is being installed
- Nuform and Laminate with a pattern will run the length of the gable
- Full Gable Supports must be used with Full Height Spine Frames
- For single-sided applications, use 18" mid supports for 24" D surfaces and 24" mid supports for 30" D surfaces
- Nuform Herringbone tile options is only available on the outside of the end gable.

NOTES

In order to get a total cost on products when upcharges are present take the list price of the product number and add the upcharge cost shown to the list price.

For example:

Product INBFEG28.548 with inside and outside in Laminate with fixed height worksurfaces supports on both sides would be \$915 +\$807 +\$886 +\$220

| Product number | H | W | Neutral paint/ base price | Accent paint | Inside tile finish options | | | | | |
|---------------------|---------|-----|------------------------------|-----------------|----------------------------|--------|-------------------|------------------|----------|---------------------|
| | | | | | No tile | Paint | Nuform classic | Nuform select | Laminate | Grade 1 laminate |
| INBFEG28.548 | 28 1/2" | 48" | \$915 | +\$94 | +\$0 | +\$162 | +\$524 | +\$582 | +\$807 | +\$826 |
| INBFEG28.560 | 28 1/2" | 60" | \$987 | +\$101 | +\$0 | +\$341 | +\$546 | +\$606 | +\$814 | +\$882 |

| Product number | Outside tile finish options | | | | | | | |
|---------------------|-----------------------------|--------|-------------------|------------------|----------------------------------|---------------------------------|----------|---------------------|
| | No tile | Paint | Nuform classic | Nuform select | Nuform Herringbone classic | Nuform Herringbone select | Laminate | Grade 1 laminate |
| INBFEG28.548 | — | +\$228 | +\$886 | +\$984 | +\$991 | +\$1100 | +\$886 | +\$944 |
| INBFEG28.560 | — | +\$231 | +\$945 | +\$1050 | +\$1058 | +\$1174 | +\$945 | +\$1035 |



Full Gable End Support

Worksurface support options

| Product number | Fixed height | Manual Height Adjustable | Electric Height Adjustable | Electric and Manual Height Adjustable | Electric Height Adjustable & Fixed | Manual Height Adjustable & Fixed |
|---------------------|--------------|-----------------------------|-------------------------------|--|---------------------------------------|-------------------------------------|
| INBFEG28.548 | +\$220 | +\$220 | — | +\$111 | +\$111 | +\$220 |
| INBFEG28.560 | +\$220 | +\$220 | — | +\$111 | +\$111 | +\$220 |

Worksurfaces & Supports

Worksurfaces Supports
Full Gable

Bench

- When specifying a Full Gable End Supports, choose the base, then option of inside and outside tiles and finally choose the worksurface support option
- Full Gable End Supports have options of Nuform, laminate, paint or no tile
- Full Gable Mid Support is available in paint and no tile
- Option "NO" interior tile when a Trading Desk unit is being installed
- Nuform and Laminate with a pattern will run the length of the gable
- Full Gable Supports must be used with Full Height Spine Frames
- For single-sided applications, use 18" mid supports for 24" D surfaces and 24" mid supports for 30" D surfaces

- Nuform Herringbone tile options is only available on the outside of the end gable.

NOTES

In order to get a total cost on products when upcharges are present take the list price of the product number and add the upcharge cost shown to the list price.

For example:

Product INBFEG28.548 with inside and outside in Laminate with fixed height worksurfaces supports on both sides would be \$915 +\$807 +\$886 +\$220

| Product number | H | W | Neutral paint/ base price | Accent paint | Inside tile finish options | | | | | |
|----------------------|-------|-----|------------------------------|-----------------|----------------------------|--------|-------------------|------------------|----------|---------------------|
| | | | | | No tile | Paint | Nuform classic | Nuform select | Laminate | Grade 1 laminate |
| INBSFEG28.524 | 28 ½" | 24" | \$567 | +\$59 | +\$0 | +\$121 | +\$465 | +\$516 | +\$465 | +\$495 |
| INBSFEG28.530 | 28 ½" | 30" | \$611 | +\$63 | +\$0 | +\$125 | +\$496 | +\$550 | +\$496 | +\$544 |

| Product number | Outside tile finish options | | | | | | | |
|----------------------|-----------------------------|--------|-------------------|------------------|----------------------------------|---------------------------------|----------|---------------------|
| | No tile | Paint | Nuform classic | Nuform select | Nuform Herringbone classic | Nuform Herringbone select | Laminate | Grade 1 laminate |
| INBSFEG28.524 | — | +\$121 | +\$465 | +\$516 | +\$521 | +\$578 | +\$465 | +\$495 |
| INBSFEG28.530 | — | +\$125 | +\$496 | +\$550 | +\$556 | +\$617 | +\$496 | +\$544 |

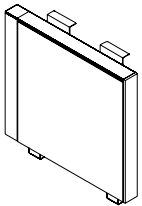

Worksurface support options

| Product number | Fixed height | Manual Height Adjustable | Electric Height Adjustable | Electric and Manual Height Adjustable | Electric Height Adjustable & Fixed | Manual Height Adjustable & Fixed |
|----------------------|--------------|-----------------------------|-------------------------------|--|---------------------------------------|-------------------------------------|
| INBSFEG28.524 | +\$111 | +\$111 | — | — | — | — |
| INBSFEG28.530 | +\$111 | +\$111 | — | — | — | — |

Single-Sided Full
Gable End Support

Worksurfaces & Supports

Worksurfaces Supports
Full Gable

- When specifying a Full Gable End Supports, choose the base, then option of inside and outside tiles and finally choose the worksurface support option
- Full Gable End Supports have options of Nuform, laminate, paint or no tile
- Full Gable Mid Support is available in paint and no tile
- Option "NO" interior tile when a Trading Desk unit is being installed
- Nuform and Laminate with a pattern will run the length of the gable
- Full Gable Supports must be used with Full Height Spine Frames
- For single-sided applications, use 18" mid supports for 24" D surfaces and 24" mid supports for 30" D surfaces

- 36" D single-sided Bench applications are not available
- Nuform Herringbone tile options is only available on the outside of the end gable.

NOTES

In order to get a total cost on products when upcharges are present take the list price of the product number and add the upcharge cost shown to the list price.

For example:

Product INBFEG28.512 with inside and outside in paint with fixed height worksurfaces supports on both sides would be \$682

| Product number | H | W | Neutral paint/ base price | Accent paint | Inside tile finish options | | | | | |
|---------------------|-------|-----|------------------------------|-----------------|----------------------------|-------|-------------------|------------------|----------|---------------------|
| | | | | | No tile | Paint | Nuform classic | Nuform select | Laminate | Grade 1 laminate |
| INBFEG28.512 | 28 ½" | 12" | \$682 | +\$70 | -\$92 | \$0 | — | — | — | — |
| INBFEG28.518 | 28 ½" | 18" | \$714 | +\$73 | -\$104 | \$0 | — | — | — | — |
| INBFEG28.524 | 28 ½" | 24" | \$748 | +\$77 | — | \$0 | — | — | — | — |

| Product number | Outside tile finish options | | | | | | | |
|---------------------|-----------------------------|-------|-------------------|------------------|----------------------------------|---------------------------------|----------|---------------------|
| | No tile | Paint | Nuform classic | Nuform select | Nuform Herringbone classic | Nuform Herringbone select | Laminate | Grade 1 laminate |
| INBFEG28.512 | -\$92 | +\$0 | — | — | — | — | — | — |
| INBFEG28.518 | -\$104 | +\$0 | — | — | — | — | — | — |
| INBFEG28.524 | — | +\$0 | — | — | — | — | — | — |



Full Gable Mid Support

Worksurface support options

| Product number | Fixed height | Manual Height Adjustable | Electric Height Adjustable | Electric and Manual Height Adjustable | Electric Height Adjustable & Fixed | Manual Height Adjustable & Fixed | Manual height adjustable (M) on left & fixed (F) on right | Fixed (F) on left & manual height adjustable (M) on right |
|---------------------|--------------|-----------------------------|-------------------------------|---|--|--|--|--|
| INBFEG28.512 | — | — | — | — | — | — | — | — |
| INBFEG28.518 | — | — | — | — | — | — | — | — |
| INBFEG28.524 | — | — | — | — | — | — | — | — |

| | | | |
|---|---|---|---|
| M | F | F | M |
|---|---|---|---|

Worksurfaces & Supports

Worksurfaces Supports
Full Gable Brackets

- Brackets for field reconfiguration purposes only
- The handedness of these brackets is chosen from the user perspective of the fixed worksurface

| | Part number | H | D | Neutral paint/ base price | Accent paint |
|---|--|-------|-----|------------------------------|-----------------|
|  <p>Full Gable Mid Support Bracket Only for Supporting 2 Fixed Height Surfaces</p> | INBKTEGFF12 12" D Full Gable | 28 ½" | 12" | \$98 | +\$13 |
| | INBKTEGFF18 18" D Full Gable | 28 ½" | 18" | \$105 | +\$13 |
| | INBKTEGFF24 24" D Full Gable | 28 ½" | 24" | \$114 | +\$15 |

Worksurfaces & Supports

Worksurfaces Supports
Open A Leg

Bench

- When specifying an Open A Leg Support, choose the base, then choose the worksurface support option
- Can be used with Partial Height Spine Frames only
- A Legs have a lower cover included when electric height adjustable worksurface supports are optioned
- Manual height adjustable is not available for use with the A Leg due to partial height bench frame restrictions
- 36" D applications are not available with the A Leg

NOTES

In order to get a total cost on products when upcharges are present take the list price of the product number and add the upcharge cost shown to the list price.

For example:

Product INBAALEG28.548 with fixed worksurfaces supports on both sides would be \$834 +\$204



| | Part number | H | W | Neutral paint/ base price | Accent paint |
|--|-----------------------|-------|-----|------------------------------|--------------|
| Open A Leg End Support For use with regular height applications | INBAALEG28.548 | 28 ½" | 48" | \$834 | +\$105 |
| | INBAALEG28.560 | 28 ½" | 60" | \$875 | +\$110 |

Worksurface support options

| Product number | Fixed height | Manual Height Adjustable | Electric Height Adjustable | Electric and Manual Height Adjustable | Electric Height Adjustable & Fixed | Manual Height Adjustable & Fixed |
|-----------------------|--------------|--------------------------|----------------------------|---------------------------------------|------------------------------------|----------------------------------|
| INBAALEG28.548 | +\$204 | — | +\$0 | — | +\$102 | — |
| INBAALEG28.560 | +\$215 | — | +\$0 | — | +\$108 | — |

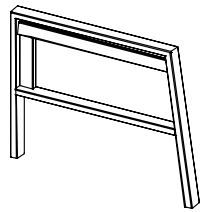

| | Part number | H | W | Neutral paint/ base price | Accent paint |
|---|---|-------|-----|------------------------------|--------------|
| Single-Sided Open A Leg End Support For use with regular height applications | INBAAEG28.524LH left-handed (illustrated) | 28 ½" | 24" | \$660 | +\$76 |
| | INBAAEG28.524RH right-handed | 28 ½" | 24" | \$660 | +\$76 |
| | INBAAEG28.530LH left-handed (illustrated) | 28 ½" | 30" | \$847 | +\$78 |
| | INBAAEG28.530RH right-handed | 28 ½" | 30" | \$684 | +\$78 |

Worksurface support options

| Product number | Fixed height | Manual Height Adjustable | Electric Height Adjustable | Electric and Manual Height Adjustable | Electric Height Adjustable & Fixed | Manual Height Adjustable & Fixed |
|------------------------|--------------|--------------------------|----------------------------|---------------------------------------|------------------------------------|----------------------------------|
| INBAAEG28.524LH | +\$77 | — | +\$0 | — | — | — |
| INBAAEG28.524RH | +\$77 | — | +\$0 | — | — | — |
| INBAAEG28.530LH | +\$83 | — | +\$0 | — | — | — |
| INBAAEG28.530RH | +\$83 | — | +\$0 | — | — | — |

Worksurfaces & Supports

Worksurfaces Supports
Open A Leg

Bench

- Can be used with Partial Height Spine Frames only
- For double-sided applications, use 12" mid supports for 24"D surfaces and 18" mid supports for 30"D surfaces
- For single-sided applications, use 18" mid supports for 24"D surfaces and 24" mid supports for 30" D surfaces
- 36"D applications are not available with the A Leg

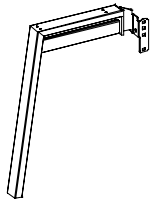

Open A Leg Mid Support
For use with regular height applications

| Part number | H | W | Neutral paint/ base price | Accent paint |
|---------------------|-------|-----|------------------------------|-----------------|
| INBAEG28.512 | 28 ½" | 12" | \$429 | +\$45 |
| INBAEG28.518 | 28 ½" | 18" | \$453 | +\$47 |
| INBAEG28.524 | 28 ½" | 24" | \$522 | +\$53 |

Worksurface support options

| Product number | Fixed height | Manual Height Adjustable | Electric Height Adjustable | Electric and Manual Height Adjustable | Electric Height Adjustable & Fixed | Manual Height Adjustable & Fixed | Manual height adjustable (M) on left & fixed (F) on right | Fixed (F) on left & manual height adjustable (M) on right |
|---------------------|--------------|--------------------------|----------------------------|---------------------------------------|------------------------------------|----------------------------------|---|---|
| INBAEG28.512 | – | – | – | – | – | – | – | – |
| INBAEG28.518 | – | – | – | – | – | – | – | – |
| INBAEG28.524 | – | – | – | – | – | – | – | – |

| | | | |
|---|---|---|---|
| M | F | F | M |
|---|---|---|---|

Worksurfaces & Supports

Worksurfaces Supports
Open H Leg

Bench

- When specifying an Open H Leg Support, choose the base, then choose the worksurface support option
- Can be used with Full Height, Partial Height and Storage Spine Frames
- Regular height (28.5") available
- Has the ability to support various accessories which hang from the support bar of the leg
- When the Electric Height Adjustable worksurface support option is selected there will be exposed bracket mounting holes visible. For no holes, specify For Electric Height Adjustable Application Only

NOTES

In order to get a total cost on products when upcharges are present take the list price of the product number and add the upcharge cost shown to the list price.

For example:

Product INBAHLEG28.548 with fixed height worksurfaces supports on both sides would be \$1196 +\$278

| | Part number | H | W | Neutral paint/ base price | Accent paint |
|--|-----------------------|-------|-----|------------------------------|--------------|
|  Open H Leg End Support For use with regular height applications | INBAHLEG28.548 | 28 ½" | 48" | \$1196 | +\$123 |
| | INBAHLEG28.560 | 28 ½" | 60" | \$1219 | +\$125 |

Worksurface support options

| Product number | Fixed height | Manual Height Adjustable | Electric Height Adjustable | Electric and Manual Height Adjustable | Electric Height Adjustable & Fixed | Manual Height Adjustable & Fixed |
|-----------------------|--------------|--------------------------|----------------------------|---------------------------------------|------------------------------------|----------------------------------|
| INBAHLEG28.548 | +\$278 | +\$125 | +\$0 | +\$63 | +\$140 | +\$201 |
| INBAHLEG28.560 | +\$278 | +\$125 | +\$0 | +\$63 | +\$140 | +\$201 |

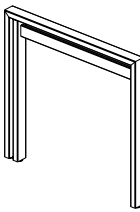
| | Part number | H | W | Neutral paint/ base price | Accent paint |
|---|---|-------|-----|------------------------------|--------------|
|  Single-Sided Open H Leg End Support For use with regular height applications | INBAHEG28.524LH left-handed (illustrated) | 28 ½" | 24" | \$791 | +\$83 |
| | INBAHEG28.524RH right-handed | 28 ½" | 24" | \$791 | +\$83 |
| | INBAHEG28.530LH left-handed (illustrated) | 28 ½" | 30" | \$847 | +\$88 |
| | INBAHEG28.530RH right-handed | 28 ½" | 30" | \$847 | +\$88 |

Worksurface support options

| Product number | Fixed height | Manual Height Adjustable | Electric Height Adjustable | Electric and Manual Height Adjustable | Electric Height Adjustable & Fixed | Manual Height Adjustable & Fixed |
|------------------------|--------------|--------------------------|----------------------------|---------------------------------------|------------------------------------|----------------------------------|
| INBAHEG28.524LH | +\$140 | +\$63 | +\$0 | — | — | — |
| INBAHEG28.524RH | +\$140 | +\$63 | +\$0 | — | — | — |
| INBAHEG28.530LH | +\$140 | +\$63 | +\$0 | — | — | — |
| INBAHEG28.530RH | +\$140 | +\$63 | +\$0 | — | — | — |

Worksurfaces & Supports

Worksurfaces Supports
Open H Leg

- Can be used with Full Height, Partial Height and Storage Spine Frames
- For double-sided applications, use 12" mid supports for 24"D surfaces, 18" mid supports for 30"D surfaces and 24" mid supports for 36"D surfaces
- For single-sided applications, use 18" mid supports for 24"D surfaces and 24" mid supports for 30"D surfaces
- Covers for "H" leg are specified when the holes on the interior of the leg are exposed when electric height adjustable is specified. These covers come 4 in a package and two are required under each worksurface

| | Part number | H | W | Neutral paint/ base price | Accent paint |
|---|--|-------|-----|------------------------------|-----------------|
|  | Open H Leg Mid Support | | | | |
| | For use with regular height applications | | | | |
| | | | | | |
| | INBHEG28.512 | 28 ½" | 12" | \$435 | +\$47 |
| | INBHEG28.518 | 28 ½" | 18" | \$485 | +\$51 |
| | INBHEG28.524 | 28 ½" | 24" | \$557 | +\$58 |

Worksurface support options

| Product number | Fixed height | Manual Height Adjustable | Electric Height Adjustable | Electric and Manual Height Adjustable | Electric Height Adjustable & Fixed | Manual Height Adjustable & Fixed | Manual height adjustable (M) on left & fixed (F) on right | Fixed (F) on left & manual height adjustable (M) on right |
|---------------------|--------------|--------------------------|----------------------------|---------------------------------------|------------------------------------|----------------------------------|---|---|
| INBHEG28.512 | — | — | — | — | — | — | — | — |
| INBHEG28.518 | — | — | — | — | — | — | — | — |
| INBHEG28.524 | — | — | — | — | — | — | — | — |

| | |
|---|---|
| M | F |
|---|---|

| | |
|---|---|
| F | M |
|---|---|

| | Part number | H | W | Neutral paint/ base price | Accent paint |
|---|-------------------|----------------------|------|------------------------------|-----------------|
|  | H Leg Hole Covers | | | | |
| | | INBHLEGCOVR-4 | 7/8" | 1 3/4" | \$20 |

Worksurfaces & Supports

Worksurfaces Supports
Open O Leg

Bench

- When specifying an Open O Leg Support, choose the base, then choose the worksurface support option
- Open O Leg Supports can be used with Full Height, Partial Height and Storage Spine Frames
- Open O legs have the option to add glazed inserts which are available in clear, gray and etched 1 side glass. See example for how to price glazed inserts
- Has the ability to support various accessories which hang from the support bar of the leg
- Use Open H leg Mid Supports to support mid applications
- For single-sided applications, use 18" mid supports for 24" D surfaces and 24" mid supports for 30" D surfaces
- 36" D single-sided Bench applications are not available

NOTES

In order to get a total cost on products when upcharges are present take the list price of the product number and add the upcharge cost shown to the list price.

For example:

Product INBAHLEG28.548 with fixed height worksurfaces supports on both sides would be \$1016 +\$278
Product INBAHLEG28.548 with fixed height worksurfaces supports on both sides and Gray glazed insert would be \$1016 +\$278 + \$466 +\$54

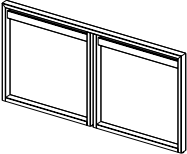
| | Part number | H | W | Neutral paint/base price | Glazed Insert options | | | Accent paint |
|---|-----------------------|-------|-----|--------------------------|-----------------------|-------|---------------|--------------|
| | | | | | Clear/base | Gray | Etched 1 side | |
|  <p>Open O Leg End Support For use with regular height applications</p> | INBAOLEG28.548 | 28 ½" | 48" | \$1016 | \$466 | +\$54 | +\$162 | +\$104 |
| | INBAOLEG28.560 | 28 ½" | 60" | \$1052 | \$665 | +\$77 | +\$229 | +\$107 |

Worksurface support options

| Product number | Fixed height | Manual Height Adjustable | Electric Height Adjustable | Electric and Manual Height Adjustable | Electric Height Adjustable & Fixed | Manual Height Adjustable & Fixed |
|-----------------------|--------------|--------------------------|----------------------------|---------------------------------------|------------------------------------|----------------------------------|
| INBAOLEG28.548 | +\$278 | +\$125 | — | +\$63 | +\$140 | +\$201 |
| INBAOLEG28.560 | +\$278 | +\$125 | — | +\$63 | +\$140 | +\$201 |

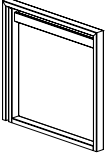
| | | | | | | | | | |
|---|---------------------------|-------|-----|-------|-------|-------|--------|-------|--|
|  <p>Single-Sided Open O Leg End Support For use with regular height applications</p> | INBAOEG28.524LH | 28 ½" | 24" | \$796 | \$358 | +\$56 | +\$105 | +\$84 | |
| | left-handed (illustrated) | | | | | | | | |
| | INBAOEG28.524RH | 28 ½" | 24" | \$796 | \$358 | +\$56 | +\$105 | +\$84 | |
| | right-handed | | | | | | | | |
| | INBAOEG28.530LH | 28 ½" | 30" | \$871 | \$400 | +\$48 | +\$139 | +\$90 | |
| left-handed (illustrated) | | | | | | | | | |
| | INBAOEG28.530RH | 28 ½" | 30" | \$871 | \$400 | +\$48 | +\$139 | +\$90 | |
| right-handed | | | | | | | | | |

Worksurface support options

| Product number | Fixed height | Manual Height Adjustable | Electric Height Adjustable | Electric and Manual Height Adjustable | Electric Height Adjustable & Fixed | Manual Height Adjustable & Fixed |
|------------------------|--------------|--------------------------|----------------------------|---------------------------------------|------------------------------------|----------------------------------|
| INBAOEG28.524LH | +\$140 | +\$63 | — | — | — | — |
| INBAOEG28.524RH | +\$140 | +\$63 | — | — | — | — |
| INBAOEG28.530LH | +\$140 | +\$63 | — | — | — | — |
| INBAOEG28.530RH | +\$140 | +\$63 | — | — | — | — |



Worksurfaces & Supports

Worksurfaces Supports

For Electric Height Adjustable Application Only

Bench

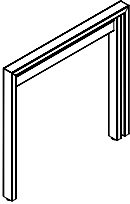
- Supports for Electric Height Adjustable applications only
- No holes will be visible on these supports
- For single-sided applications, use 18" mid supports for 24" D surfaces and 24" mid supports for 30" D surfaces
- 36" D single-sided Bench applications are not available

| | | Part number | W | D | Neutral paint/ base price | Accent paint |
|---|---|-----------------------|-------|-----|------------------------------|-----------------|
|  | Open H Leg End Support for Height Adjustable Worksurfaces only For use with regular height applications | INBHLEGHAW48 | 28 ½" | 48" | \$1035 | +\$105 |
| | | INBHLEGHAW60 | 28 ½" | 60" | \$1041 | +\$106 |
|  | Single-Sided Open H Leg End Support for Height Adjustable Worksurfaces only For use with regular height applications | INBHLEGHAW24LH | 28 ½" | 24" | \$642 | +\$65 |
| | | INBHLEGHAW24RH | 28 ½" | 24" | \$642 | +\$65 |
| | | INBHLEGHAW30LH | 28 ½" | 30" | \$717 | +\$73 |
| | | INBHLEGHAW30RH | 28 ½" | 30" | \$717 | +\$73 |
|  | Full Gable Mid Support for Height Adjustable Worksurfaces only For use with regular height applications | INBFEGADJ12 | 28 ½" | 12" | \$682 | +\$70 |
| | | INBFEGADJ18 | 28 ½" | 18" | \$693 | +\$71 |
| | | INBFEGADJ24 | 28 ½" | 24" | \$726 | +\$74 |

Bench Storage

inscape

work for tomorrow

PEDESTALS

Pedestals are of all-welded "wrap-around" construction of 20 and 22 gauge high quality, tension leveled, cold rolled steel. The steel gauge selected for drawer fronts, bodies and accessories ensure the highest quality durability and performance for all components. All glides on cases must be specified as flat glides (5/8" height adjustability) to work with Inscape Bench. Pedestal corners are welded at junction of top and case, eliminating horizontal lines for a cleaner, flush appearance, and strengthened with reinforcing gussets. A completely enclosed case provides rigid construction and dust-free interiors.

Box drawer sides are slotted on 1" centers to allow for maximum flexibility for drawer division. Double-wall construction allows lift-up doors to be picked up and recede smoothly, eliminates deformation, ensures flush fit within cabinet and improves lock performance. Storage with Handles is single-wall construction. File (10.5" and 12") and EDP (15") drawer bodies have full height sides to accommodate hanging file folders, eliminating the need for optional file frames. Fully progressive ball bearing suspensions on all drawers, including pencil and box drawers, are staged so that the left and right sides work in unison; this provides smooth drawer operation with minimum force. Staged suspensions allow the drawer to be completely pulled out, providing access to the entire drawer depth.

Special "claw-like" device incorporated in the suspension "grips" the fixed section of the suspension channel preventing drawer body bounce back or creep when drawer is closed. Modular interior allows complete interchangeability of drawer types within the pedestal case. For example, two 6" box drawers may be replaced by a 12" file drawer. Pedestals are standard with keyholes for attachment to underside of worksurface. For the Storage with Handles only cases: 18" deep pedestals come standard with 18" deep drawers, 22" and 28" deep pedestals come standard with 22" deep drawers. For all other Series, pedestal drawers match case depth.

Worksurface supporting pedestals are designed for use with the Inscape Bench when used with flat glides. Worksurface supporting pedestals are available in two depths to fit 24" and 30" deep worksurfaces and support finished worksurface height of 28.5". Pedestals with 3", 6" or 7.5" drawers have the option to order one pencil tray per pedestal. The 6" and 7.5" drawers have the additional option to order a steel divider. The 10.5" and 12" drawers have the option to order hang file suspension bar (two in a 28" deep pedestal) for side-to-side filing of legal or letter size folders or printout binders.

NOTE: System storage pedestal cases consist of holes in the top of the case and back of the case to allow for worksurface docking and panel mounted brackets to be secured.

CUSHION MOBILE PEDESTALS

The Classic Cushion is 1 1/4" thick CAL 117 compliant polyurethane foam with a 2.2 lb/ft. density. This upholstered cushion is balanced with a 7/16" board and is attached to the pedestal top with heavy duty Velcro.

Select from our graded upholstery program of solid color fabrics and vinyl's or choose COM option (Customers Own Material). To determine if a COM fabric has been pre-approved for use on our cushion topper, contact your client services representative or go to www.inscapesolutions.com. For application of ALL fabrics, both from our graded program as well as COM (Customer Own Material) please specify layout orientation at time of order. If layup instructions are not provided Inscape will choose the direction to maximize production. Refer to the diagram for layup options.

After calculating the total amount of material needed in inches, divide the total number of inches by 36 for the total yardage and round up to the next full yard. Allow additional for repeat. Add 15% of total fabric required for small and medium pattern repeats. Add 20% of total fabric required for large patterns.

Due to the nature of the design and manufacture of our cushion, only approved fabrics will be accepted for application. For a description of the procedure required for COM fabric approval see sample 'Cushion COM Test Request' form found in the General Information section of this price list. This form can be downloaded from the Administration section of Insite or by contacting your client services representative for assistance.

FABRIC LAY UP OF PEDESTAL CUSHIONS

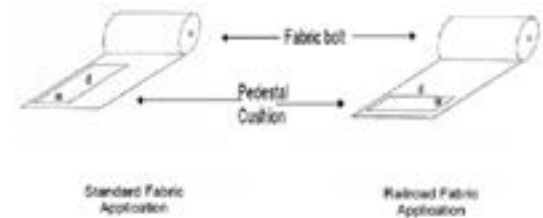

Pedestals come standard with lock. If lock is not required add suffix '/NL' after product number and deduct \$57 list per lock. Random keying is standard, and keyed alike may be ordered.

Locks feature removable core and are standard with two keys, one of which has a black neoprene plastic key cover. Locks may be ordered for field installation. Specify cabinet height and width or model number. Note: Locks cannot be field installed on hinged door cabinets.

LATERALS

Lateral cabinets are of all-welded construction using 20 and 22 gauge high quality, tension leveled, and cold rolled steel. Drawer fronts, lift-up doors, roll-out shelves and all steel accessories are manufactured of the steel gauge appropriate to function at the highest quality level. Laterals must be specified with flat glides to work with Inscape Bench. Flat Glides provide 0.125" height adjustment when docked and 0.75" height adjustment if unit is not docked.

With the addition of counterweights where appropriate, cabinets meet all BIFMA specifications. All interiors are completely modular and interchangeable so that cabinets can be retrofitted with new accessories and interiors as required. Cabinet corners (except for Storage with Handles) are welded at junction of top and case, eliminating horizontal lines for cleaner, flush appearance, and strengthened with reinforcing gussets. Double-wall construction allows lift-up doors to be picked up and receded smoothly, eliminates deformation, ensures flush fit within cabinet and improves lock performance. Lift-up door carrier mechanism has four nylon rollers two on each side - for smooth receding action with no binding or snagging. Self-closing, 110° opening, European style cupboard hinges for smooth door operations.

The absence of scissor mechanism in doors and drawers eliminates the potential for scissors binding, and facilitates reconfiguration of cabinet openings as needed. Front leading edge of pullout shelves is beaded and rolled to provide grip for pullout action and strengthen shelf; front leading edge of fixed shelf is flat for easy removal of material. Fully progressive ball bearing suspension slides provide smooth action with minimum force.

Special "claw-like" device incorporated in suspension slide channel "grips" the fixed section of the suspension channel preventing drawer bounce-back or creep when drawer is closed. A patented Safelock™ interlock mechanism provides complete security and user safety against accidental opening of two or more drawers simultaneously. Lock fingers are configured with right angle bend upward not downward so that lift-up doors cannot be pulled down to disengage fingers from door slots and be forced to circumvent lock system. Lock bars operate vertically on both sides of cabinet for maximum security.

Knockouts that are included on case sides, top and bottom facilitate ganging and leveling. Glides - 2 in front and 2 in back - are adjustable from inside the cabinet so that cabinets can be leveled regardless of whether they are backed against a wall or banked.

9900 Series fronts have full width integral pulls with enamel finish to match case fronts. Storage with Handles fronts are available with 2 pull options. The standard pull option is the radius aluminum pull. A rectangular aluminum pull option is also available at no additional cost. Storage with Handles is single-wall construction. Nuform fronts include a Q- pull.

Laterals include 1 pair of hang file bars in 10.5" and 12" fixed fronts, 1 EDP kit in 13.5" and 15" fixed fronts, pencil tray in 3" multi-file drawer and steel divider in 7.5" multi-file drawer, steel divider in 6" multi-file drawers and 3 divider plates in 13.5" lift-ups. Fixed shelf in lift-up is slotted in 1" increments. Lateral to panel bracket is required if lateral is positioned on-module.

NOTE: laterals and multi-files consist of slots in the back of the case to allow for panel mounted brackets to be secured.

Cabinets ship standard with single bitted lock. For applications requiring higher security a double bitted solution is available. If lock is not required it may be optioned as such. Random keying is standard, keyed alike is optional. Cabinets originally ordered as non-locking may be field installed with the addition of locking bars and a lock core. Contact your client services representative for required parts. Locks may not be field installed in hinged door and sliding door cabinets. Master keys are available; refer to the accessories section to specify. Locks are standard with two keys, one of which has a black neoprene plastic cover.

All laterals are finished in standard 36.5° gloss baked enamel, electrostatically applied in a 2-coat process. Refer to the surface materials section for available colors. With the exception of custom micas, whites and metallic; custom colors are available at an up-charge and are be subject to extended lead times. For laterals specified in custom micas, specials whites or metallic, add an up-charge of 10% to the list price. All interior drawers/shelf bodies, exposed hardware (excluding European style hinges) hang file bars, dividers and media frames are finished in Eco Black.

TWIN-BINS

Twin-Bins are 5.75" deep on each side of the supporting frame. Twin-Bins may be specified to install in stack frames above the worksurface. Bins are manufactured from minimum 20 gauge steel with an extruded aluminum reinforced top. Double wall, sliding doors on each side of the unit, slide easily across the recessed groove built into the bin front. Twin-Bins are available with or without locks. The locking mechanism is individualized for each side of the unit, allowing for personal privacy on either side. Twin-Bins are available in 36", 42", 48" and 60" W. Recommended maximum load for Twin-Bins is 3lbs per linear inch. Bins are finished in standard 37.5° gloss baked enamel, electrostatically applied in a 2-coat process and are available in any of the colors shown in our Color Guide. Woodgrain fronts are available in any of our standard woodgrain finishes.

Handles are standard in aluminum finish and are located on the front of the sliding door. Case may still be ordered in any of the colors shown in our Color Guide.

ELECTRIFIED TWIN BIN

The Electrified Twin Bin is built on the same premise as the standard Twin Bin with the addition of electrical and a sliding door with locking capabilities in two positions. All electrical components are specified separately including power track, receptacles and jumper cables. The sliding door may lock either the binder storage portion (full depth of bin) or the electrified portion which is the center portion which is approximately 5"D. The back of the Electrified Twin Bin may be clad with either a tackboard or whiteboard which are both specific to this storage unit. A shelf may also be optioned for the electrified portion which is field installed midway between top and bottom of opening. A gap in the shelf allows for the cord of an electronic unit to plug into duplex (located near base of opening) and still sit on top of shelf.

NOTE: These accessories are NOT compatible with the standard Twin Bin.

See Inscape Bench Application Guide for criteria on which heights of stack-on to use in conjunction with the Twin Bin and Electrified Twin Bin.

SPECIFY TWIN-BIN MOUNTING BRACKETS

Specify Twin-Bin Mounting Brackets separately according to location on frame. 1 bracket per Twin-Bin is required. When stacking Twin-Bins a 6.75" H tile minimum must separate the two. Do not specify over Power Track Kit. It is not recommended to specify Twin-Bins on wing panels. Twin-Bins should only be specified on spine panels for adequate stability. See Inscape Bench Application Guide for details.

DRAWER STANDARD EQUIPMENT

Lockers and towers containing 3" or 6" drawers are provided with one pencil tray per cabinet. 6" drawers are additionally standard with one steel divider. 10.5", 12" and 15" letter-width file drawers have one suspension bar for side-to-side filing of letter or legal-size folders. Full-width pullout drawers are standard with one pair hang file bars for side-to-side suspended filing. Full-width fixed shelves are standard with 3 plate dividers. Optional accessories are available.



GLIDES

Overall heights are inclusive of metal glides. Heights may be increased up to 5/8" by extending the standard glide. Glides are accessible from inside the cabinet when the bottom drawer is fully extended or removed and may be adjusted with a 0.25" socket driver. Optional 1.5" stem glides are available. Specify and add \$24 list to the cabinet price. Requires field installation.

FRONT DETAILS & PULL OPTIONS

9900 Series fronts have full width integral pulls with enamel finish to match case fronts.

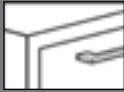
Storage with Handles have the following styles options. FP005 is the default pull.

| Pull | Storage with Handles |
|---|----------------------|
|  FP001 P290 Aluminum Leaf Finish | ● |
|  FP004 Brushed Nickel Finish | ● |
|  FP005 Satin Nickel Finish | ● |

● Available ○ Unavailable

Pulls FP004 and FP005 meet the guidelines for ADA compliance.

LOCKS

Workplace Towers and Lockers come standard with lock with single bitted lock. For applications requiring higher security, a double bitted solution is available. If lock is not required add suffix '**NL**' after product number. Deduct \$57 list per lock.

Locks are available in chrome and black finish. Specify. Random keying is standard. Files may be ordered keyed alike. Locks feature removable core and are standard with two keys, one of which has a black Neoprene plastic key cover. Cabinets originally ordered as non-locking may be field installed with the addition of locking bars and a lock core. Please contact Inscape Client Services for required parts. Locks may not be field installed in hinged and sliding door cabinets. Specify lateral file height and width or model number. Master keys are available at \$51 list.

CUSTOM COLORS

Inscape System offers color matched to a customers' specification when possible. This matching is done through a database of over 2,000 existing color formulas or the development of a new custom color. A minimum order value of \$3,000 net per custom color, applies to each order. A \$250 net fee applies for each custom color below this minimum. In addition, Custom premium colors (bright whites and bright colors; textured paints; and reflection paints that use mica, aluminum or special chemical to create their reflective properties) will be subject to a 10% upcharge to the net value of the product.



- Includes holes in top and bracket slots in back of case
- Worksurface supporting for 28.5" H
- Be sure to specify a 3/8" top along with spacers to achieve a 28.5" finished worksurface height
- **FLAT GLIDE ONLY** when used with Inscape Bench

OPTIONAL ACCESSORIES

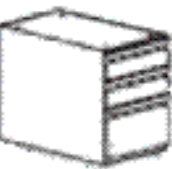

All pedestal accessories are optional. See chart below for information an accessories by drawer height.

| Drawer Height | Product Code | Product Description | Price |
|--|--------------|----------------------------|-------|
| 3" & 4.5" | PFWS-PTxx | Pencil Tray | \$37 |
| 6" & 7.5" | PFWS-PTxx | Pencil Tray | \$37 |
| | PFWS-DVxx | Divider | \$22 |
| 18"D, 22"D, 28"D Pedestals Only (28"D requires 2 per drawer) | | | |
| 10.5", 12", 13.5, & 15" | PFSSFxx | Side-To-Side Filing Bar | \$8 |



Visit the [Pedestal Accessories](#) section for full accessory details.

| | Part number | H | W | D | Wt (lbs) | Neutral paint/ base price | Accent paint |
|---|---------------------------------------|---------|-----|---------|----------|------------------------------|-----------------|
|  | INGE1522-F10F | 25 3/8" | 15" | 22 3/4" | 95 | \$914 | +\$94 |
| | INGE1528-F10F Letter Width | 25 3/8" | 15" | 28 3/4" | 105 | \$950 | +\$98 |
|  | INGE1522-2BF10 | 25 3/8" | 15" | 22 3/4" | 95 | \$1036 | +\$105 |
| | INGE1528-2BF10 Letter Width | 25 3/8" | 15" | 28 3/4" | 105 | \$1086 | +\$111 |
|  | INGE1522-PB7F | 25 3/8" | 15" | 22 3/4" | 95 | \$1038 | +\$106 |
| | INGE1528-PB7F Letter Width | 25 3/8" | 15" | 28 3/4" | 105 | \$1090 | +\$111 |

- Worksurface supporting for 28.5" H
- Be sure to specify a 3/8" top along with spacers to achieve a 28.5" finished worksurface height
- **FLAT GLIDE ONLY** when used with Inscape Bench

| | | Part number | H | W | D | Wt (lbs) | Neutral paint/ base price | Accent paint |
|--|--|---------------------|---------|-----|-----|----------|------------------------------|-----------------|
|  | 10.5" file, 12" file Flat Glides | 3022.5H-F10F | 25 3/8" | 30" | 18" | — | \$1083 | +\$110 |
| | | 3622.5H-F10F | 25 3/8" | 36" | 18" | — | \$1188 | +\$121 |
| | | 4222.5H-F10F | 25 3/8" | 42" | 18" | — | \$1306 | +\$133 |
|  | 3" pencil, 7.5" box, 12" file Flat Glides | 3022.5H-PB7F | 25 3/8" | 30" | 18" | — | \$1112 | +\$114 |
| | | 3622.5H-PB7F | 25 3/8" | 36" | 18" | — | \$1212 | +\$125 |
| | | 4222.5H-PB7F | 25 3/8" | 42" | 18" | — | \$1331 | +\$135 |



- Worksurface supporting for 28.5" H
- Be sure to specify a 3/8" top along with spacers to achieve a 28.5" finished worksurface height
- **FLAT GLIDE ONLY** when used with Inscape Bench

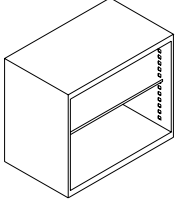

| | | Part number | H | W | D | Wt (lbs) | Neutral paint/ base price | Accent paint |
|---|--|------------------------|---------|-----|-----|----------|------------------------------|-----------------|
|  | 10.5" file, 12" file Flat Glides | IN3022.5E-F10F | 25 3/8" | 30" | 18" | — | \$1095 | +\$111 |
| | | IN3622.5E-F10F | 25 3/8" | 36" | 18" | — | \$1200 | +\$123 |
| | | IN4222.5E-F10F | 25 3/8" | 42" | 18" | — | \$1318 | +\$134 |
|  | 2-6" box, 10.5" file Flat Glides | IN3022.5E-2BF10 | 25 3/8" | 30" | 18" | — | \$1251 | +\$128 |
| | | IN3622.5E-2BF10 | 25 3/8" | 36" | 18" | — | \$1384 | +\$140 |
| | | IN4222.5E-2BF10 | 25 3/8" | 42" | 18" | — | \$1511 | +\$153 |
|  | 3" pencil, 7.5" box, 12" file Flat Glides | IN3022.5E-PB7F | 25 3/8" | 30" | 18" | — | \$1123 | +\$115 |
| | | IN3622.5E-PB7F | 25 3/8" | 36" | 18" | — | \$1228 | +\$126 |
| | | IN4222.5E-PB7F | 25 3/8" | 42" | 18" | — | \$1344 | +\$137 |

- Worksurface supporting for 28.5" H
- Be sure to specify a 3/8" top along with spacers to achieve a 28.5" finished worksurface height
- **FLAT GLIDE ONLY** when used with Inscape Bench

| | Part number | H | W | D | Wt (lbs) | Neutral paint/ base price | Accent paint | |
|---|---------------------------------------|-----------------------|---------|-----|----------|------------------------------|-----------------|--------|
|  | Inscape Bench Bookcase Flat Glides | IN3022.5-1BK18 | 25 3/8" | 30" | 18" | — | \$1065 | +\$108 |
| | | IN3622.5-1BK18 | 25 3/8" | 36" | 18" | — | \$1115 | +\$114 |
| | | IN4222.5-1BK18 | 25 3/8" | 42" | 18" | — | \$1183 | +\$121 |

- See Inscape Bench Application Guide for bracket details & locations
- Twin-Bin brackets are quoted separately and are specific to panel thickness
- Twin-Bin cannot be installed directly above a worksurface as it causes interference
- Jumper cables and receptacles for the Electrified Twin Bin power track specified separately
- The “IN3D_UD-8” receptacles are to be specified in conjunction with the Electrified Twin-Bin
- See Inscape System Application Guide for bracket details and locations
- Twin-Bin brackets are specific to frame thickness
- “2F” denotes use with 2.75" thick frame
- Brackets are for use with Bench stack-on frames only

| | | Part number | H | W | Wt (lbs) | Nuform classic/ neutral paint/ base price | Nuform select | Accent paint |
|--|-----------------------------------|-------------------|-----|-----|----------|---|------------------|-----------------|
|  | Nuform Front Twin-Bin | INTWQB36LH | 14" | 36" | 42 | \$1449 | +\$161 | +\$146 |
| | | INTWQB42LH | 14" | 42" | 52 | \$1506 | +\$167 | +\$153 |
| | | INTWQB48LH | 14" | 48" | 58 | \$1558 | +\$172 | +\$159 |
| | | INTWQB54LH | 14" | 54" | 62 | \$1576 | +\$174 | +\$161 |
| | | INTWQB60LH | 14" | 60" | 68 | \$1593 | +\$177 | +\$162 |
|  | Nuform Front Electrified Twin-Bin | INETWBQ36 | 14" | 36" | 42 | \$1886 | +\$209 | +\$191 |
| | | INETWBQ42 | 14" | 42" | 52 | \$1975 | +\$219 | +\$200 |
| | | INETWBQ48 | 14" | 48" | 58 | \$2024 | +\$225 | +\$205 |
| | | INETWBQ54 | 14" | 54" | 62 | \$2048 | +\$227 | +\$207 |
| | | INETWBQ60 | 14" | 60" | 68 | \$2071 | +\$229 | +\$209 |

| | | Part number | W | List price |
|---|---|------------------------|-----|------------|
|  | Twin-Bin Bracket for install on a 20.25" H Stack-on | INTWBKTUH-36-2F | 36" | \$178 |
| | | INTWBKTUH-42-2F | 42" | \$180 |
| | | INTWBKTUH-48-2F | 48" | \$183 |
| | | INTWBKTUH-54-2F | 54" | \$185 |
| | | INTWBKTUH-60-2F | 60" | \$188 |
|  | Twin-Bin Bracket for install on a 27" H Stack-on | INTWBKT-U | — | \$114 |

- Electrified Twin Bin shelf is installed in opening where electrical is located (center)
- Electrified Twin Bin Whiteboard + Tackboard only compatible with Electrified Twin Bin
- Receptacles are available in color options of black (default), white and gray
- White close match to 168 Glacier White and Gray close match to 290 – Aluminum Leaf
- The circuit 3 receptacle requires 2+2 or 3+1 wire designation (“4” in the code signifies 3+1 compatibility)
- USB power modules can be used with the Electrified Twin-Bin

NOTE

Only Expo Markers are to be used on any Inscape Whiteboard. Whiteboards should be cleaned with Expo Eraser or a Microfiber cleaning cloth along with Expo Cleaning Solution which is formulated to remove residue from Expo Dry Erase Markers.

| | Part number | H | W | Grade 1/ COM/ base price | Grade 2 | Grade 3 | Grade 4 | Grade 5 | Grade 6 | Grade 7 | Grade 8 |
|---|-------------------|-----|-----|--------------------------------|---------|---------|---------|---------|---------|---------|---------|
|  | INTWBTB-12 | 14" | 12" | \$130 | +\$8 | +\$16 | — | +\$29 | — | +\$74 | — |
| | INTWBTB-14 | 14" | 14" | \$133 | +\$8 | +\$16 | — | +\$29 | — | +\$74 | — |
| | INTWBTB-16 | 14" | 16" | \$139 | +\$8 | +\$16 | — | +\$29 | — | +\$74 | — |
| | INTWBTB-18 | 14" | 18" | \$145 | +\$8 | +\$16 | — | +\$29 | — | +\$74 | — |
| | INTWBTB-20 | 14" | 20" | \$159 | +\$8 | +\$16 | — | +\$29 | — | +\$74 | — |

Electrified Twin-Bin Tackboard

| | Part number | H | W | Wt (lbs) | Base price | Accent paint |
|---|---------------------|---|-----|----------|------------|--------------|
|  | INETWBSHF-12 | — | 12" | — | \$105 | +\$13 |
| | INETWBSHF-14 | — | 14" | — | \$105 | +\$13 |
| | INETWBSHF-16 | — | 16" | — | \$105 | +\$13 |
| | INETWBSHF-18 | — | 18" | — | \$105 | +\$13 |
| | INETWBSHF-20 | — | 20" | — | \$105 | +\$13 |

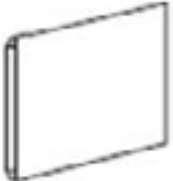
| | | | | | | |
|---|-------------------|-----|-----|---|------|---|
|  | INTWBWB-12 | 14" | 12" | — | \$39 | — |
| | INTWBWB-14 | 14" | 14" | — | \$39 | — |
| | INTWBWB-16 | 14" | 16" | — | \$39 | — |
| | INTWBWB-18 | 14" | 18" | — | \$45 | — |
| | INTWBWB-20 | 14" | 20" | — | \$45 | — |

| | | | | | | |
|---|-------------------|---|----|---|------|---|
|  | INETPTWB-8 | — | 8" | — | \$88 | — |
|---|-------------------|---|----|---|------|---|

| | Part number | Black/ baseprice | White | Gray |
|---|--------------------|---------------------|-------|-------|
|  | IN3D1-UD-8 | \$27 | +\$11 | +\$11 |
| | IN3D2-UD-8 | \$27 | +\$11 | +\$11 |
| | IN3D3-UD-8 | \$27 | +\$11 | +\$11 |
| | IN3D3U-UD-8 | \$27 | +\$11 | +\$11 |
| | IN3D4-UD-8 | \$27 | +\$11 | +\$11 |

Bench Accessories

inscape

work for tomorrow

Spine Accessories are units that may be specified to sit on top of any of the benching spines. The units are specified to include the stanchion kit or not (see notes on page). Height Adjustable worksurfaces must not be specified when spine accessories are specified due to interference with the lift mechanism. The only exception to this is Add on Glazing.

ADD-ON GLAZING

Add-on Glazing is manufactured from ¼" tempered glass. A ⅜" tempered glass is also available. Glazing may be mounted to the top of any equivalent Inscape Bench spine or combination of bases outlined in the Application Guide. Glazing is available in clear, gray, etched one or two sides and designer glass Strie options. Add-on Glazing includes top trim, glass mounting extrusion and specified glass. Add-on Glazing is specified based on the thickness of the panel. **Note: Special Hi-lo Add-on Glazing must be specified when installed directly adjacent to a higher panel at an inline situation only.** The glaze and extrusion are inset on one side to allow for hi-lo vertical trim on the adjacent higher panel. If the situation calls for hi-lo on both sides, a special may be required. An Add on Glazing alignment clip is included with each Add on Glaze ordered in the ¼" thickness option.

TRANSACTION TOPS

Transaction Tops are specific to spine width they are to be installed on. Stanchions and top trim are included in the kit, as well as a 1" thick Nuform or laminate top. Hi-Lo Transaction Top must be specified when a transaction top is specified directly adjacent to a higher panel. The worksurface takes into account the profile of the end trim.

On the Inset Transaction Top, the worksurface is inset 5" on each side from the ends of the top cap.

NOTE: 72", 84" and 96" W kits consist of two top caps and four stanchions (based on "Symmetrical Frame Configuration" module lines). Top Caps can be specified as an option and are included with the kit.

UP-MOUNT BIN

The Up-mount Bin is constructed of 24 gauge steel on the back and 20 gauge steel on bottom, sides and top. The Up-mount Bin is ordered and shipped independent of the stanchion kit, top trim and accessories to hang on back of bin. The stanchion kit includes hardware to mount the stanchions on the crossrail of the frame and top trim (tapered or flat). Stanchion kits are specified based on thickness of frame in which the Up-mount Bin is being installed. The backs of all Up-mount Bins require either a whiteboard or a tackboard to provide a clean aesthetic. These accessories are specific to the Up-mount Bin and include mounting hardware. The stanchion and Up-mount Bin provide an overall height of 20.25" module matching adjacent panel heights. The bin is 12.75" deep and may be specified directly adjacent to another Up-mount Bin facing the opposite direction; creating a "Twin- Bin" effect. Separate top cap and two stanchions will be required for each bin.

OPEN LEG ACCESSORIES

Open Leg Accessories are units which hang from the Open H Leg, O Leg or A Leg on the Inscape Bench. Most of these units are constructed of laminate and come complete with all brackets to hang. With the exception of the Worksurface Extension which is not compatible with height adjustable worksurfaces, these units may be specified when a Height Adjustable worksurface is being used. The units sit 2" lower than the worksurface so there is no concern of pinch points when lowering the worksurface. The weight capacity of shelves is 100 lbs and all other units are 200 lbs. The HipStach is a painted unit and is available in any of Inscape's standard colors.

SPINE DIVIDERS

Spine Dividers are situated on top of the bench spine only – full height or partial. They come complete with brackets and hardware to mount on the frame as well as a top cap. Dividers may span over two frame (see application guide). The tackable version is for tackability only. The two heights of divider match overall A.F.F heights of 37" and 44". Tackable Spine Divider is a 1.125" thick fabric wrapped panel.

WORKSURFACE DIVIDER

Worksurface Divider may only be used with Bench as the depth correlates with the worksurface depth of the benching surfaces. All hardware is included to mount the divider on the worksurface. It does not deface the worksurface and can be used with either 1" or 1 ¼" thick surfaces. Spine Divider Accessories have a slightly different aesthetic as Inscape System paper accessories. Accessories cannot hang on the tackboard spine divider.

WORKSURFACE MOUNTED CORNER SCREENS

Worksurface mounted corner screens mount to main surface to provide privacy for the user. All worksurface mounted corner screens are handed left or right. The handedness is determined from the user perspective (i.e. a left handed screen would install on the left hand side of the user). The overall screen height is half way between a 44" H and a 51" H frame; 3.37" above the 44" frame height. Screens are available in two types; curved wood and metal. Screens have an optional feature for a tackable fabric "skin" on the inside.

Metal worksurface mounted corner screens can be painted any of the standard color. The optional fabric skin on a metal screen is only on the interior back. Only metal worksurface mounted corner screens are compatible with freestanding height adjustable worksurfaces.

UPMOUNT SHELF

Upmount shelves have a transaction top style shelf with a wrap around screen. Upmount shelves can be use with either parallel or 90° worksurface applications. The overall height is half way between a 44" H and a 51" H frame when mounted on a Bench spine frame (3.37" above the 44" frame height) and matches the overall height of a Worksurface Mounted Corner Screen. The shelf can be optioned in Nuform and laminate. The screens are available in metal. Screens have an optional feature for a tackable fabric "skin" on the inside.

The metal screens on the upmont shelves can be painted any of the standard color. The optional fabric skin on a metal screen is only on the interior back.

Back to back metal upmount shelves are handed left or right. The handedness is determined from the user perspective (i.e. a left handed screen would be open on the left hand side when user is looking at the spine).

- Planter box include painted rectangular stanchions kits and trim for spine mount
- 72" (36" top caps) wide kits consist of two top caps and four stanchions
- Flat trim profile only
- On-module installation only
- Planter box is available in both laminate and metal construction
- Planter box is not available with plywood edge band

NOTES

In order to get a total cost on products when upcharges are present take the list price of the product number and add the upcharge cost shown to the list price.

For example:

Product INBPLNTTOP-36 in Grade 1 Laminate would be \$2206 +\$708

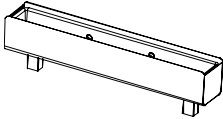

| Part number | H | W | D | Neutral paint/ base price | Accent paint |
|---------------------|------|-----|------|------------------------------|-----------------|
| INBMLNTTOP30 | 5 ¼" | 30" | 4 ½" | \$539 | +\$56 |
| INBMLNTTOP36 | 5 ¼" | 36" | 4 ½" | \$574 | +\$59 |
| INBMLNTTOP48 | 5 ¼" | 48" | 4 ½" | \$748 | +\$77 |
| INBMLNTTOP60 | 5 ¼" | 60" | 4 ½" | \$805 | +\$83 |



| Part number | H | W | D | Laminate/ base price | Grade 1 laminate | Accent paint |
|----------------------|----|-----|----|-------------------------|---------------------|-----------------|
| INBPLNTTOP-36 | 6" | 36" | 6" | \$2206 | +\$708 | +\$222 |
| INBPLNTTOP-42 | 6" | 42" | 6" | \$2337 | +\$750 | +\$237 |
| INBPLNTTOP-48 | 6" | 48" | 6" | \$2465 | +\$790 | +\$249 |
| INBPLNTTOP-60 | 6" | 60" | 6" | \$2594 | +\$832 | +\$262 |



- Transaction Tops include painted rectangular stanchions kits and trim for spine mount
- 72" (36" top caps) wide kits consist of two top caps and four stanchions
- Transaction Top is available in 1" Nuform or Laminate
- On the Inset Transaction Top, the worksurface is inset 5" on each side from the ends of the top cap
- Flat trim profile only
- On-module installation only

NOTES

In order to get a total cost on products when upcharges are present take the list price of the product number and add the upcharge cost shown to the list price.

For example:





Product INBTRANTOP-36 in Grade 1 Laminate would be \$426 ++\$142

| | Part number | H | W | D | Nuform classic/ laminate/ base price | Nuform select | Grade 1 laminate | Grade 2 laminate | Accent paint |
|---|----------------------|---------|-----|-----|--|------------------|---------------------|---------------------|-----------------|
|  Transaction Top | INBTRANTOP-36 | 6 5/16" | 36" | 12" | \$426 | +\$23 | +\$142 | +\$283 | +\$46 |
| | INBTRANTOP-42 | 6 5/16" | 42" | 12" | \$451 | +\$25 | +\$139 | +\$276 | +\$48 |
| | INBTRANTOP-48 | 6 5/16" | 48" | 12" | \$486 | +\$27 | +\$148 | +\$296 | +\$51 |
| | INBTRANTOP-54 | 6 5/16" | 54" | 12" | \$511 | +\$29 | +\$157 | +\$312 | +\$53 |
| | INBTRANTOP-60 | 6 5/16" | 60" | 12" | \$517 | +\$29 | +\$161 | +\$319 | +\$54 |
| | INBTRANTOP-72 | 6 5/16" | 72" | 12" | \$848 | +\$45 | +\$262 | +\$519 | +\$88 |
|  Inset Transaction Top | INBACTRTOP-36 | 6 5/16" | 36" | 12" | \$451 | +\$23 | +\$142 | +\$283 | +\$48 |
| | INBACTRTOP-42 | 6 5/16" | 42" | 12" | \$463 | +\$25 | +\$139 | +\$276 | +\$49 |
| | INBACTRTOP-48 | 6 5/16" | 48" | 12" | \$486 | +\$27 | +\$148 | +\$296 | +\$51 |
| | INBACTRTOP-54 | 6 5/16" | 54" | 12" | \$511 | +\$29 | +\$157 | +\$312 | +\$53 |
| | INBACTRTOP-60 | 6 5/16" | 60" | 12" | \$517 | +\$29 | +\$161 | +\$319 | +\$54 |
| | INBACTRTOP-72 | 6 5/16" | 72" | 12" | \$848 | +\$45 | +\$262 | +\$519 | +\$88 |

- Up-mount overhead bins MUST always be specified to include a tackboard or whiteboard
- Up-mount bins stanchions must be specified to support a frame mounted up-mount bin
- “INB” Stanchion Kit must be used with Inscape Bench only
- Top caps included with stanchion kits and are specified to match frame and bin width
- Optional colored insert and shelf available for Up-Mount bin only
- Up-Mount shelf mounts below the Up-Mount Bin on module
- Stanchions are specific to the Bench frame and can not be used with Inscape System

NOTE

Only Expo Markers are to be used on any Inscape Whiteboard. Whiteboards should be cleaned with Expo Eraser or a Microfiber cleaning cloth along with Expo Cleaning Solution which is formulated to remove residue from Expo Dry Erase Markers.

| | Part number | H | W | D | Neutral paint/ base price | Accent paint | |
|---|--|---------------------|---------|-----|------------------------------|-----------------|-------|
|  | Up-Mount Bin | INPHUMB30 | 14" | 30" | — | \$657 | +\$67 |
| | | INPHUMB36 | 14" | 36" | — | \$677 | +\$69 |
| | | INPHUMB42 | 14" | 42" | — | \$709 | +\$72 |
| | | INPHUMB48 | 14" | 48" | — | \$724 | +\$74 |
| | | INPHUMB54 | 14" | 54" | — | \$755 | +\$77 |
| | | INPHUMB60 | 14" | 60" | — | \$829 | +\$87 |
|  | Stanchion Kit for Up-Mount Bins For use with Bench spine frames | INBUSKT30-2F | 13 1/2" | 30" | 2 3/4" | \$657 | +\$67 |
| | | INBUSKT36-2F | 13 1/2" | 36" | 2 3/4" | \$677 | +\$69 |
| | | INBUSKT42-2F | 13 1/2" | 42" | 2 3/4" | \$709 | +\$72 |
| | | INBUSKT48-2F | 13 1/2" | 48" | 2 3/4" | \$724 | +\$74 |
| | | INBUSKT54-2F | 13 1/2" | 54" | 2 3/4" | \$755 | +\$77 |
| | | INBUSKT60-2F | 13 1/2" | 60" | 2 3/4" | \$829 | +\$87 |
|  | Colored Insert for back of bin For Up-Mounted bin only | IN12INSRT30 | 12 1/8" | 30" | — | \$108 | +\$15 |
| | | IN12INSRT36 | 12 1/8" | 36" | — | \$116 | +\$15 |
| | | IN12INSRT42 | 12 1/8" | 42" | — | \$121 | +\$16 |
| | | IN12INSRT48 | 12 1/8" | 48" | — | \$128 | +\$16 |
|  | Up-Mount Bin Whiteboard | INUBWHB1430 | 14" | 30" | — | \$48 | — |
| | | INUBWHB1436 | 14" | 36" | — | \$52 | — |
| | | INUBWHB1442 | 14" | 42" | — | \$59 | — |
| | | INUBWHB1448 | 14" | 48" | — | \$65 | — |
| | | INUBWHB1454 | 14" | 54" | — | \$74 | — |
| | | INUBWHB1460 | 14" | 60" | — | \$77 | — |

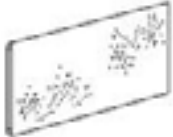
| | Part number | H | W | Grade 1/ COM/ base price | Grade 2 | Grade 3 | Grade 4 | Grade 5 | Grade 6 | Grade 7 | Grade 8 | |
|---|------------------------|--------------------|-----|--------------------------------|---------|---------|---------|---------|---------|---------|---------|---|
|  | Up-Mount Bin Tackboard | INUBTAC1430 | 14" | 30" | \$195 | +\$7 | +\$12 | — | +\$29 | — | +\$77 | — |
| | | INUBTAC1436 | 14" | 36" | \$198 | +\$12 | +\$22 | — | +\$44 | — | +\$103 | — |
| | | INUBTAC1442 | 14" | 42" | \$204 | +\$13 | +\$23 | — | +\$45 | — | +\$106 | — |
| | | INUBTAC1448 | 14" | 48" | \$209 | +\$13 | +\$23 | — | +\$48 | — | +\$115 | — |
| | | INUBTAC1454 | 14" | 54" | \$212 | +\$12 | +\$25 | — | +\$47 | — | +\$114 | — |
| | | INUBTAC1460 | 14" | 60" | \$219 | +\$10 | +\$22 | — | +\$46 | — | +\$114 | — |

- 3/8" top is installation ready, complete with double sided tape for adhesion to case
- Sliding door must be mounted on two up-mount bins of equal size that are side by side

| | Part number | W | D | Nuform classic/ base price | Nuform select |
|---|-------------------------|-----|-------|-------------------------------|------------------|
|  | 3/8" T Up-Mount Bin Top | | | | |
| | PHUMBTOP-1330 | 30" | 13" | \$187 | +\$20 |
| | PHUMBTOP-1336 | 36" | 13" | \$221 | +\$17 |
| | PHUMBTOP-1342 | 42" | 13" | \$245 | +\$27 |
| | PHUMBTOP-1348 | 48" | 13" | \$272 | +\$30 |
| | PHUMBTOP-1354 | 54" | 13" | \$299 | +\$31 |
| | PHUMBTOP-1360 | 60" | 13" | \$327 | +\$34 |
| | PHUMBTOP-1372 | 72" | 13" | \$429 | +\$45 |
| | PHUMBTOP-1384 | 84" | 13" | \$479 | +\$48 |
| PHUMBTOP-1396 | 96" | 13" | \$526 | +\$54 | |

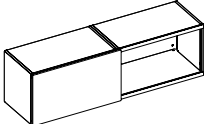
| | Part number | W | Nuform classic/ laminated/ base price | Nuform select | Grade 1 laminated |
|---|--|-------|---|------------------|----------------------|
|  | Sliding Door & Track Up-Mount bin specified separately | | | | |
| | INUMBSLDR30 | 30" | \$564 | +\$63 | +\$182 |
| | INUMBSLDR36 | 36" | \$580 | +\$65 | +\$187 |
| | INUMBSLDR42 | 42" | \$589 | +\$66 | +\$191 |
| INUMBSLDR48 | 48" | \$605 | +\$67 | +\$196 | |

- For use with Inscape Bench only
- Screens and shelves (both metal and wood) have an OPTIONAL feature for a tackable fabric "skin" on the inside. Base price is without skin
- The fabric skin on the wood screens wraps all the way around the interior of the screen. On metal screens it is only on interior back
- Wood upmount shelf screens are finished in a clear coat on maple
- Wood upmount shelves and screens have a 5.5" curved corner while metal upmount shelves and screens have a 1" corner
- Metal upmount shelf screens can be painted in all standard colors
- Back to back metal upmount shelves are handed left or right. The handedness is determined from the user perspective (i.e. a left handed screen would be open on the left hand side when user is looking at the spine)

- Upmount shelves can be use with either parallel or 90° worksurface applications; however, they can NOT be used on fully freestanding straight applications. Even one where docking brackets are used
- 72" sizes come with a 72" top cap

NOTES

In order to get a total cost on products when upcharges are present take the list price of the product number and add the upcharge cost shown to the list price.

For example:

Product INBUPSHELFM-36 with a Grade D fabric skin and a Grade 1 laminate shelf would be \$941 +\$0 +\$62 +\$142

| Part number | H | W | D | List/ base price | Fabric skin options | | | | | | Accent paint |
|-------------|---|---|---|------------------------|-----------------------|----------------|------------|------------|------------|------------|-----------------|
| | | | | | No fabric layer | Grade A/COM | Grade B | Grade C | Grade D | Grade E | |



Single Metal
Upmount Shelf

| | | | | | | | | | | | | |
|---|---------|-----|--------|--------|--------|------|-------|-------|-------|--------|--------|--------|
| INBUPSHELFM-36 | 14.062" | 26" | 9 1/2" | \$941 | -\$156 | +\$0 | +\$43 | +\$52 | +\$62 | +\$69 | +\$81 | +\$97 |
| For use with a 36" w spine frame | | | | | | | | | | | | |
| INBUPSHELFM-60 | 14.062" | 50" | 9 1/2" | \$1115 | -\$175 | +\$0 | +\$43 | +\$52 | +\$62 | +\$69 | +\$81 | +\$114 |
| For use with a 60" w spine frame | | | | | | | | | | | | |
| INBUPSHELFM-72 | 14.062" | 62" | 9 1/2" | \$1298 | -\$206 | +\$0 | +\$59 | +\$74 | +\$92 | +\$102 | +\$116 | +\$132 |
| For use with a 72" w (2x 36") spine frame | | | | | | | | | | | | |

Shelf finish options

| Product number | Nuform classic/laminate | Nuform select | Grade 1 laminate | Grade 2 lamainte |
|-----------------------|-------------------------|---------------|---------------------|---------------------|
| INBUPSHELFM-36 | +\$0 | +\$23 | +\$142 | +\$283 |
| INBUPSHELFM-60 | +\$0 | +\$29 | +\$161 | +\$319 |
| INBUPSHELFM-72 | +\$0 | +\$45 | +\$262 | +\$519 |

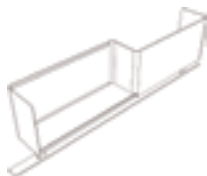

Back to Back Metal
Upmount Shelf

| | | | | | | | | | | | | |
|--|---------|-----|--------|--------|--------|------|-------|-------|-------|-------|-------|--------|
| INBUPSHELFM72LH | 14 1/8" | 62" | 9 1/2" | \$1281 | -\$164 | +\$0 | +\$31 | +\$39 | +\$48 | +\$53 | +\$60 | +\$130 |
| For use with a 72" w (2x 36") spine frame left handed (illustrated) | | | | | | | | | | | | |
| INBUPSHELFM72RH | 14 1/8" | 62" | 9 1/2" | \$1281 | -\$164 | +\$0 | +\$31 | +\$39 | +\$48 | +\$53 | +\$60 | +\$130 |
| For use with a 72" w (2x 36") spine frame right handed | | | | | | | | | | | | |

Shelf finish options

| Product number | Nuform classic/laminate | Nuform select | Grade 1 laminate | Grade 2 lamainte |
|------------------------|-------------------------|---------------|---------------------|---------------------|
| INBUPSHELFM72LH | +\$0 | +\$45 | +\$283 | +\$565 |
| INBUPSHELFM72RH | +\$0 | +\$45 | +\$283 | +\$565 |

- Add-on Glazing comes complete with mounting hardware and top cap
- Add-on Glazing may span multiple frames according to guidelines set in the Inscape Bench Application Guide
- 10.125" thick glaze available in .25" thick
- One glaze Alignment clip is included with each Add-on Glazing
- Add-on Glazing up to 60" W require two additional Jesters to be specified if spanning multiple frames (i.e. a 60" W AOG installed on 2-30" frames)
- **List/Base for 0.25" thick is clear glass**



NOTES

In order to get a total cost on products when upcharges are present take the list price of the product number and add the upcharge cost shown to the list price.

For example:

Product INAG6.7530-2F 0.25" thick glass with Gray would be \$225 +\$108

The same product upgraded to 0.38" thick glass would be \$225 +\$112 +\$273

| Part number | W | List/base / 0.25" thick glazing price | Glazing thickness option | 0.25" thick finish options | | | | 0.38" thick finish options | | | Accent paint | |
|---|------------------------|---------------------------------------|--------------------------|----------------------------|--------|---------------|---------------|----------------------------|--------|---------------|--------------|-------|
| | | | 0.38" thick glazing | Clear | Gray | Etched 1 side | Etched 2 side | Clear | Gray | Etched 1 side | | |
|  6.75" H Add-On Glazing For use with 2 3/4" T frames | INAG6.7530-2F | 30" | \$225 | +\$112 | +\$0 | +\$108 | +\$108 | +\$213 | +\$0 | +\$273 | +\$273 | +\$25 |
| | INAG6.7536-2F | 36" | \$248 | +\$124 | +\$0 | +\$119 | +\$119 | +\$260 | +\$0 | +\$295 | +\$295 | +\$27 |
| | INAG6.7542-2F | 42" | \$265 | +\$132 | +\$0 | +\$124 | +\$124 | +\$270 | +\$0 | +\$312 | +\$312 | +\$29 |
| | INAG6.7548-2F | 48" | \$286 | +\$140 | +\$0 | +\$128 | +\$128 | +\$276 | +\$0 | +\$329 | +\$329 | +\$31 |
| | INAG6.7554-2F | 54" | \$305 | +\$152 | +\$0 | +\$131 | +\$131 | +\$280 | +\$0 | +\$343 | +\$343 | +\$33 |
| | INAG6.7560-2F | 60" | \$329 | +\$164 | +\$0 | +\$144 | +\$144 | +\$310 | +\$0 | +\$376 | +\$376 | +\$35 |
| | INAG6.7566-2F | 66" | \$341 | +\$168 | +\$0 | +\$179 | +\$179 | +\$336 | +\$0 | +\$434 | +\$434 | +\$36 |
| | INAG6.7572-2F | 72" | \$358 | +\$178 | +\$0 | +\$199 | +\$199 | +\$368 | +\$0 | +\$471 | +\$471 | +\$37 |
| | INAG6.7578-2F | 78" | \$456 | +\$223 | +\$0 | +\$154 | +\$154 | +\$316 | +\$0 | +\$453 | +\$453 | +\$49 |
| | INAG6.7584-2F | 84" | \$533 | +\$263 | +\$0 | +\$129 | +\$129 | +\$282 | +\$0 | +\$453 | +\$453 | +\$56 |
| INAG6.7590-2F | 90" | \$611 | +\$302 | +\$0 | +\$102 | +\$102 | +\$250 | +\$0 | +\$453 | +\$453 | +\$63 | |
| INAG6.7596-2F | 96" | \$688 | +\$340 | +\$0 | +\$77 | +\$77 | +\$218 | +\$0 | +\$453 | +\$453 | +\$71 | |
|  10.125" H Add-On Glazing For use with 2 3/4" T frames | INAG10.12530-2F | 30" | \$226 | +\$133 | +\$0 | +\$111 | +\$111 | +\$214 | +\$0 | +\$204 | +\$204 | +\$25 |
| | INAG10.12536-2F | 36" | \$252 | +\$135 | +\$0 | +\$127 | +\$127 | +\$259 | +\$0 | +\$207 | +\$207 | +\$27 |
| | INAG10.12542-2F | 42" | \$277 | +\$139 | +\$0 | +\$138 | +\$138 | +\$285 | +\$0 | +\$210 | +\$210 | +\$30 |
| | INAG10.12548-2F | 48" | \$301 | +\$160 | +\$0 | +\$153 | +\$153 | +\$310 | +\$0 | +\$239 | +\$239 | +\$32 |
| | INAG10.12554-2F | 54" | \$324 | +\$179 | +\$0 | +\$166 | +\$166 | +\$332 | +\$0 | +\$268 | +\$268 | +\$34 |
| | INAG10.12560-2F | 60" | \$353 | +\$185 | +\$0 | +\$183 | +\$183 | +\$369 | +\$0 | +\$285 | +\$285 | +\$37 |
| | INAG10.12566-2F | 66" | \$373 | +\$200 | +\$0 | +\$211 | +\$211 | +\$398 | +\$0 | +\$309 | +\$309 | +\$39 |
| | INAG10.12572-2F | 72" | \$415 | +\$214 | +\$0 | +\$210 | +\$210 | +\$400 | +\$0 | +\$333 | +\$333 | +\$45 |
| | INAG10.12578-2F | 78" | \$496 | +\$229 | +\$0 | +\$180 | +\$180 | +\$366 | +\$0 | +\$358 | +\$358 | +\$52 |
| | INAG10.12584-2F | 84" | \$569 | +\$246 | +\$0 | +\$162 | +\$162 | +\$337 | +\$0 | +\$383 | +\$383 | +\$59 |
| INAG10.12590-2F | 90" | \$642 | +\$259 | +\$0 | +\$138 | +\$138 | +\$310 | +\$0 | +\$408 | +\$408 | +\$65 | |
| INAG10.12596-2F | 96" | \$718 | +\$274 | +\$0 | +\$119 | +\$119 | +\$283 | +\$0 | +\$434 | +\$434 | +\$73 | |

- Add-on Glazing comes complete with mounting hardware and top cap
- Add-on Glazing may span multiple frames according to guidelines set in the Inscape Bench Application Guide
- 10.125" thick glaze available in .25" thick
- One glaze Alignment clip is included with each Add-on Glazing
- Add-on Glazing up to 60" W require two additional Jesters to be specified if spanning multiple frames (i.e. a 60" W AOG installed on 2-30" frames)
- **List/Base for 0.25" thick is clear glass**

NOTES

In order to get a total cost on products when upcharges are present take the list price of the product number and add the upcharge cost shown to the list price.

For example:

Product INAG10.12530-2F 0.25" thick glass with Gray would be \$226 +\$111

The same product upgraded to 0.38" thick glass would be \$226 +\$133 +\$204

| Part number | W | List/base / 0.25" thick glazing price | Glazing thickness option | 0.25" thick finish options | | | | 0.38" thick finish options | | | Accent paint | |
|---|----------------------|---------------------------------------|--------------------------|----------------------------|------|---------------|---------------|----------------------------|------|---------------|--------------|-------|
| | | | 0.38" thick glazing | Clear | Gray | Etched 1 side | Etched 2 side | Clear | Gray | Etched 1 side | | |
|  | INAG13.530-2F | 30" | \$227 | +\$114 | +\$0 | +\$112 | +\$112 | +\$214 | +\$0 | +\$277 | +\$277 | +\$25 |
| | INAG13.536-2F | 36" | \$256 | +\$128 | +\$0 | +\$133 | +\$133 | +\$258 | +\$0 | +\$324 | +\$324 | +\$27 |
| | INAG13.542-2F | 42" | \$287 | +\$142 | +\$0 | +\$156 | +\$156 | +\$301 | +\$0 | +\$371 | +\$371 | +\$31 |
| | INAG13.548-2F | 48" | \$317 | +\$157 | +\$0 | +\$178 | +\$178 | +\$343 | +\$0 | +\$421 | +\$421 | +\$33 |
| | INAG13.554-2F | 54" | \$347 | +\$171 | +\$0 | +\$199 | +\$199 | +\$383 | +\$0 | +\$465 | +\$465 | +\$36 |
| | INAG13.560-2F | 60" | \$376 | +\$185 | +\$0 | +\$220 | +\$220 | +\$427 | +\$0 | +\$513 | +\$513 | +\$42 |
| | INAG13.566-2F | 66" | \$404 | +\$200 | +\$0 | +\$245 | +\$245 | +\$459 | +\$0 | +\$561 | +\$561 | +\$44 |
| | INAG13.572-2F | 72" | \$470 | +\$229 | +\$0 | +\$220 | +\$220 | +\$470 | +\$0 | +\$560 | +\$560 | +\$50 |
| | INAG13.578-2F | 78" | \$535 | +\$264 | +\$0 | +\$208 | +\$208 | +\$413 | +\$0 | +\$571 | +\$571 | +\$56 |
| | INAG13.584-2F | 84" | \$604 | +\$296 | +\$0 | +\$196 | +\$196 | +\$393 | +\$0 | +\$586 | +\$586 | +\$62 |
| | INAG13.590-2F | 90" | \$671 | +\$331 | +\$0 | +\$173 | +\$173 | +\$371 | +\$0 | +\$586 | +\$586 | +\$69 |
| | INAG13.596-2F | 96" | \$739 | +\$366 | +\$0 | +\$160 | +\$160 | +\$348 | +\$0 | +\$599 | +\$599 | +\$76 |

13.5" H Add-On Glazing
For use with 2 3/4" T frames

- For use with Inscape Bench only
- 1.125" thick soft feel fabric wrapped tackboard panel
- Includes hardware and top cap
- Laminate divider accessories are not compatible with this panel

NOTES

In order to get a total cost on products when upcharges are present take the list price of the product number and add the upcharge cost shown to the list price.

For example:

Product INBAPF1636 in Grade C would be \$813 +\$280

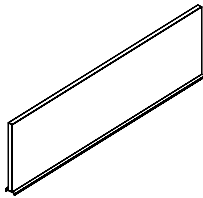

| Part number | H | W | Thickness | Grade A/ base price | Grade B/ COM | Grade C | Grade D | Grade E | Grade F | Accent paint |
|-------------------|---------|-----|-----------|------------------------|-----------------|---------|---------|---------|---------|-----------------|
| INBAPF1636 | 16.875" | 36" | 1 1/8" | \$813 | +\$147 | +\$280 | +\$366 | +\$441 | +\$629 | +\$85 |
| INBAPF1642 | 16.875" | 42" | 1 1/8" | \$867 | +\$172 | +\$296 | +\$426 | +\$512 | +\$732 | +\$90 |
| INBAPF1648 | 16.875" | 48" | 1 1/8" | \$925 | +\$167 | +\$295 | +\$469 | +\$569 | +\$818 | +\$96 |
| INBAPF1660 | 16.875" | 60" | 1 1/8" | \$1037 | +\$273 | +\$439 | +\$574 | +\$697 | +\$1008 | +\$105 |
| INBAPF1666 | 16.875" | 66" | 1 1/8" | \$1120 | +\$255 | +\$526 | +\$648 | +\$787 | +\$1126 | +\$115 |
| INBAPF1672 | 16.875" | 72" | 1 1/8" | \$1190 | +\$189 | +\$476 | +\$610 | +\$758 | +\$773 | +\$121 |
| INBAPF1684 | 16.875" | 84" | 1 1/8" | \$1318 | +\$228 | +\$526 | +\$683 | +\$858 | +\$1288 | +\$134 |
| INBAPF1696 | 16.875" | 96" | 1 1/8" | \$1523 | +\$337 | +\$624 | +\$810 | +\$1007 | +\$1502 | +\$154 |

16.875" H Spine Tackable Divider
To match 44" H Frame Height and 13.5" H Worksurface Tackable Divider



| Part number | H | W | Wt (lbs) | Grade 1/ COM/ base price | Grade 2 | Grade 3 | Grade 4 | Grade 5 | Grade 6 | Grade 7 | Grade 8 | Accent paint |
|-------------------|---------|-----|----------|--------------------------------|---------|---------|---------|---------|---------|---------|---------|-----------------|
| INBRFD1630 | 16.875" | 30" | 2 3/4" | \$764 | +\$8 | +\$21 | +\$30 | +\$39 | +\$63 | +\$88 | +\$120 | +\$79 |
| INBRFD1636 | 16.875" | 36" | 2 3/4" | \$845 | +\$9 | +\$22 | +\$33 | +\$45 | +\$71 | +\$99 | +\$137 | +\$87 |
| INBRFD1642 | 16.875" | 42" | 2 3/4" | \$925 | +\$9 | +\$16 | +\$30 | +\$45 | +\$72 | +\$101 | +\$140 | +\$96 |
| INBRFD1648 | 16.875" | 48" | 2 3/4" | \$949 | +\$11 | +\$29 | +\$42 | +\$52 | +\$86 | +\$115 | +\$161 | +\$97 |
| INBRFD1654 | 16.875" | 54" | 2 3/4" | \$1023 | +\$11 | +\$31 | +\$46 | +\$59 | +\$94 | +\$128 | +\$177 | +\$104 |
| INBRFD1660 | 16.875" | 60" | 2 3/4" | \$1030 | +\$13 | +\$44 | +\$58 | +\$73 | +\$108 | +\$144 | +\$202 | +\$104 |

16.875" H Rectangular Framed Spine Divider, Tackable
To match 44" H Frame Height

- Includes hardware and top cap
- Laminate divider accessories are not compatible with this panel
- Compatible with height adjustable worksurfaces
- 17"H screen sits 13 ½" above the worksurface and matches other spine dividers
- 21"H screen sits 16 ⅞" above the worksurface but does not align with other spine dividers or frames
- Also compatible with Inscape System
- Matches the aesthetics of the RockIt screens

NOTES



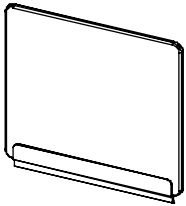

In order to get a total cost on products when upcharges are present take the list price of the product number and add the upcharge cost shown to the list price.

For example:

Product INBATF1636 in Grade C would be \$525 +\$80

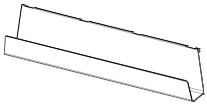
| | Part number | H | W | Thickness | Grade A/ base price | Grade B/ COM | Grade C | Grade D | Grade E | Grade F | Accent paint |
|---|-------------------|-----|-----|-----------|------------------------|-----------------|---------|---------|---------|---------|-----------------|
|  <p>Slim Fabric Tackboard Screen</p> | INBATF1636 | 17" | 36" | ½" | \$525 | +\$56 | +\$80 | +\$124 | — | — | +\$37 |
| | INBATF1642 | 17" | 42" | ½" | \$588 | +\$62 | +\$90 | +\$138 | — | — | +\$43 |
| | INBATF1648 | 17" | 48" | ½" | \$642 | +\$67 | +\$98 | +\$151 | — | — | +\$47 |
| | INBATF1654 | 17" | 54" | ½" | \$718 | +\$76 | +\$108 | +\$168 | — | — | +\$52 |
| | INBATF1660 | 17" | 60" | ½" | \$779 | +\$83 | +\$119 | +\$182 | — | — | +\$56 |
| | INBATF1666 | 17" | 66" | ½" | \$815 | +\$86 | +\$124 | +\$192 | — | — | +\$59 |
| | INBATF1672 | 17" | 72" | ½" | \$862 | +\$90 | +\$131 | +\$201 | — | — | +\$62 |
| | INBATF2036 | 21" | 36" | ½" | \$604 | +\$63 | +\$92 | +\$141 | — | — | +\$44 |
| INBATF2042 | 21" | 42" | ½" | \$678 | +\$71 | +\$103 | +\$159 | — | — | +\$49 | |
| INBATF2048 | 21" | 48" | ½" | \$738 | +\$78 | +\$112 | +\$172 | — | — | +\$53 | |
| INBATF2054 | 21" | 54" | ½" | \$826 | +\$87 | +\$126 | +\$194 | — | — | +\$59 | |
| INBATF2060 | 21" | 60" | ½" | \$897 | +\$94 | +\$135 | +\$210 | — | — | +\$64 | |
| INBATF2066 | 21" | 66" | ½" | \$938 | +\$98 | +\$142 | +\$219 | — | — | +\$66 | |
| INBATF2072 | 21" | 72" | ½" | \$992 | +\$103 | +\$151 | +\$232 | — | — | +\$71 | |

- HipStash can be hung from A Leg only and can be painted in any of Inscape's standard colors
- Lower units are hung from the Open H or O Leg
- Lower units may be specified when a Height Adjustable worksurface is installed
- Bookcases are constructed of laminate
- Accessory Hook is constructed of metal and can be painted in any of Inscape's standard colors
- Specify units based on width of the Bench
- Shelves, hook and acrylic modesty hang from the Open H or O Leg
- Laminate items are not available with plywood edge banding
- Interior dimensions for recycling and garbage doors of Lower Bookcase: 16.75"W x 12.5"H x 13.5"D

| | | Part number | H | W | D | Natural paint/ base price | Accent paint | |
|---|--|-----------------------|---------|---------|-----|------------------------------|-----------------|--------|
|  | HipStash for A Leg | INBMASHELF48 | 12" | 48" | 5" | \$591 | +\$61 | |
| | | INBMASHELF60 | 12" | 60" | 5" | \$673 | +\$69 | |
|  | Lower Bookcase with Recycling and Garbage Laminate case with metal door fronts | INBLWRBRECY-48 | 14.011" | 51 1/3" | 15" | \$4086 | +\$1309 | +\$412 |
| | | INBLWRBRECY-60 | 14.011" | 63 1/3" | 15" | \$4409 | +\$1413 | +\$442 |
|  | Lower Bookcase | INBLWRBOOK-48 | 14.011" | 51 1/3" | 15" | \$3761 | +\$1205 | +\$378 |
| | | INBLWRBOOK-60 | 14.011" | 63 1/3" | 15" | \$4150 | +\$1329 | +\$417 |
|  | Planter Box | INBPLNTEND-48 | 6" | 51 1/3" | 6" | \$2465 | +\$790 | +\$249 |
| | | INBPLNTEND-60 | 6" | 63 1/3" | 6" | \$2725 | +\$873 | +\$276 |
|  | Open Leg Accessory Hook | INBAHOOK | — | — | — | \$73 | — | +\$11 |

- Worksurface Extension are mounted to the surface and may not be specified when a Height Adjustable worksurface is installed
- Woodgrain pattern when applied on Worksurface Extension will run perpendicularly to main worksurfaces
- Worksurface Extension only to be used with Open H and O Leg end support
- Shelves, hooks hang from the Open H or O Leg; however acrylic modesty is sized to fit H Leg only
- Acrylic modesty and privacy screens may be specified when a Height Adjustable worksurface is installed
- Acrylic modesty and privacy screens can be used with both H Legs and O Legs (when no glazed insert is optioned)

- Acrylic Privacy Screens have 14" of the screen mounted above the surface
- Acrylic Privacy/Modesty Screens have 14" of the screen mounted above the surface and 16.5" below
- Acrylic - white and frosted one side only

NOTES

In order to get a total cost on products when upcharges are present take the list price of the product number and add the upcharge cost shown to the list price.

For example:

Product INBWX1848 in Grade 2 Laminate would be \$573 +\$486

| | Part number | H | D | Straight edge nuform classic/ laminate/ base price | Nuform select | Nuform tapered edge | Grade 1 laminate | Grade 2 laminate | Accent paint |
|---|------------------|---------|-----|---|------------------|---------------------------|---------------------|---------------------|-----------------|
|  | INBWX1848 | 51 1/3" | 18" | \$573 | +\$47 | +\$23 | +\$184 | +\$486 | +\$60 |
| | INBWX1860 | 63 1/3" | 18" | \$650 | +\$57 | +\$31 | +\$210 | +\$504 | +\$66 |

Worksurface
Extension

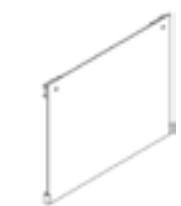
| | Part number | H | W | White/ base price | Frosted | Accent paint | |
|---|---|------------------|---------|----------------------|---------|-----------------|-------|
|  | Arylic Modesty Panel for use with H Leg only | INBAMP-24 | 24 1/6" | 22 4/5" | \$495 | +\$495 | +\$52 |
| | | INBAMP-30 | 24 1/6" | 28 4/5" | \$579 | +\$579 | +\$60 |

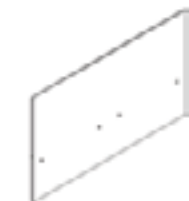
| | | | | | | | |
|---|---|--------------------|---------|---------|-------|--------|-------|
|  | Arylic Privacy Screen For privacy Matches 44" H overall | INBAPS-1948 | 18 5/8" | 50 3/4" | \$740 | +\$740 | +\$76 |
| | | INBAPS-1960 | 18 5/8" | 62 3/4" | \$828 | +\$828 | +\$86 |

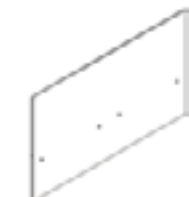
| | | | | | | | |
|---|---|--------------------|---------|---------|-------|--------|--------|
|  | Arylic Privacy Screen For modesty and privacy Matches 44" H overall | INBAPS-2948 | 28 3/4" | 50 3/4" | \$937 | +\$937 | +\$97 |
| | | INBAPS-2960 | 28 3/4" | 62 3/4" | \$983 | +\$983 | +\$101 |

- For use with Inscape Bench only
- Tackable divider is a 1.125" thick fabric wrapped tackboard panel
- Laminate divider accessories are not compatible with tackable divider
- Divider Screen for straight edge worksurfaces are available in a mid or end application option
- The end application Divider Screen can also be used on a height adjustable worksurfaces
- Divider Screen specific to tapered edge worksurfaces is 2" shorter then width stated to accommodate tapered edge and is easier to move
- Dividers Include hardware to mount to the worksurface perpendicular to spine

NOTES

In order to get a total cost on products when upcharges are present take the list price of the product number and add the upcharge cost shown to the list price.

For example:

Product INBSPDF1324 in Grade C would be \$563 +\$208

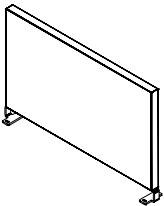
| | Part number | H | W | Thickness | Grade A/ base price | Grade B/ COM | Grade C | Grade D | Grade E | Grade F | Accent paint |
|---|--------------------|-------|-----|-----------|------------------------|-----------------|---------|---------|---------|---------|-----------------|
|  | INBSPDF1324 | 13.5" | 24" | 1 1/8" | \$563 | +\$126 | +\$208 | +\$289 | +\$341 | +\$467 | +\$59 |
| | INBSPDF1330 | 13.5" | 30" | 1 1/8" | \$620 | +\$129 | +\$259 | +\$336 | +\$399 | +\$556 | +\$64 |

13.5" H Worksurface
Tackable Divider for Mid
Application
With mounting brackets on
front and back
For use with straight edge
worksurfaces
Matches 44" H panel and
16.875" H Spine Tackable
Divider

| | | | | | | | | | | | |
|---|---------------------|-------|-----|--------|-------|--------|--------|--------|--------|--------|-------|
|  | INBSPFED1324 | 13.5" | 24" | 1 1/8" | \$563 | +\$126 | +\$208 | +\$289 | +\$341 | +\$467 | +\$59 |
| | INBSPFED1330 | 13.5" | 30" | 1 1/8" | \$620 | +\$129 | +\$259 | +\$336 | +\$399 | +\$556 | +\$64 |

13.5" H Worksurface
Tackable Divider for End
Application
With mounting brackets on
front and back
For use with straight edge
worksurfaces
Matches 44" H panel and
16.875" H Spine Tackable
Divider

- For use with Inscape Bench only
- Tackable divider is a 1.125" thick fabric wrapped tackboard panel
- Laminate divider accessories are not compatible with tackable divider
- Dividers Include hardware to mount to the worksurface perpendicular to spine
- Divider Screen for straight edge worksurfaces are available in a mid or end application option
- The end application Divider Screen can also be used on a height adjustable worksurfaces
- Divider Screen specific to tapered edge worksurfaces is 2" shorter then width stated to accommodate tapered edge and is easier to move

NOTES

In order to get a total cost on products when upcharges are present take the list price of the product number and add the upcharge cost shown to the list price.

For example:

Product INBDSDF1324 in Grade C would be \$519 +\$204

| Part number | H | W | Thickness | Grade A/ base price | Grade B/ COM | Grade C | Grade D | Grade E | Grade F | Accent paint |
|--------------------|-------|-----|-----------|------------------------|-----------------|---------|---------|---------|---------|-----------------|
| INBDSDF1324 | 13.5" | 24" | 1 1/8" | \$519 | +\$142 | +\$204 | +\$296 | +\$345 | +\$462 | +\$54 |
| INBDSDF1330 | 13.5" | 30" | 1 1/8" | \$588 | +\$139 | +\$273 | +\$332 | +\$393 | +\$539 | +\$61 |

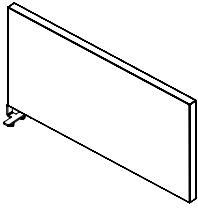

13.5" H Worksurface
Tackable Divider
With single bracket to be
mount at back of surface only
For use with tapered edge
worksurfaces
Matches 44" H panel and
16.875" H Spine Tackable
Divider

- Accessories do not hang on the tackable version of the dividers
- Slightly different design detail from Inscape System paper trays

NOTES

In order to get a total cost on products when upcharges are present take the list price of the product number and add the upcharge cost shown to the list price.

For example:

Product INBAPTRY in an accent paint would be \$85 +\$11

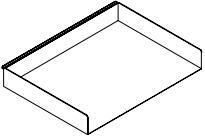
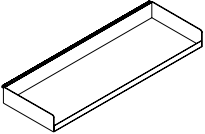
| | | Part number | H | W | D | Neutral paint/ base price | Accent paint |
|---|----------------------------------|-----------------|----|-----|----|------------------------------|--------------|
|  | Paper Tray No holes in bottom | INBAPTRY | 2" | 12" | 9" | \$85 | +\$11 |
|  | Personal Accessory Tray | INBAPSHF | 2" | 18" | 6" | \$126 | +\$16 |

Accessories

Worksurface Screens for 90° Workstations

- For use with 90° worksurface applications only
- Screens and shelves (both metal and wood) have an OPTIONAL feature for a tackable fabric "skin" on the inside. Base price is without skin
- The fabric skin on the metal screens is only on the interior back of the screen.
- All Worksurface Mounted Corner Screens have 16 7/8" above the worksurface. The curved metal screen is 6" below the surface
- Worksurface Mounted Corner Metal Screens can be painted in all of Inscape's standard colors
- All Worksurface Mounted Corner Screens are handed left or right. The handedness is determined from the user perspective (i.e. a left handed screen would install on the left hand side of the user)
- ONLY metal Worksurface Mounted Corner Screens are compatible with freestanding height adjustable worksurfaces
- There will be a 1" wire management gap between the screen and the back side of the worksurface

NOTES

In order to get a total cost on products when upcharges are present take the list price of the product number and add the upcharge cost shown to the list price.

For example:

Product INBWMCSWLH with a Grade D fabric skin would be \$1115 +\$123



Worksurface Mounted Corner Metal Screen
For use with straight 90° worksurfaces

| Part number | H | W | D | Screen list/base price | Fabric options | | | | | | | Accent paint |
|--|-----|-----|-----|------------------------|-----------------|-------------|---------|---------|---------|---------|---------|--------------|
| | | | | | No fabric layer | Grade A/COM | Grade B | Grade C | Grade D | Grade E | Grade F | |
| INBWMCSMLH left handed (illustrated) | 24" | 41" | 17" | \$660 | -\$199 | — | +\$79 | +\$101 | +\$123 | +\$137 | +\$156 | +\$67 |
| INBWMCSMRH right handed | 24" | 41" | 17" | \$660 | -\$199 | — | +\$79 | +\$101 | +\$123 | +\$137 | +\$156 | +\$67 |

Accessories

Worksurface Screens for 90° Workstations

- Slim Surface Mounted Tackable Screen is 16 7/8" above the worksurface and matches the aesthetics of the RockIt screens. It has 6" below the surface.
- Can be mounted on any 1" or 1 1/4" thick worksurface
- Can also be used with Inscape System worksurfaces, freestanding fixed tables and freestanding height adjustable tables

NOTES

In order to get a total cost on products when upcharges are present take the list price of the product number and add the upcharge cost shown to the list price.

For example:

Product INBTBMPS2536 in Grade B would be \$700 +\$73

| Part number | H | W | Thickness | Grade A/ base price | Grade B/ COM | Grade C | Grade D | Accent paint |
|---------------------|-----|-----|-----------|------------------------|-----------------|---------|---------|-----------------|
| INBTBMPS2536 | 24" | 36" | 1/2" | \$700 | +\$73 | +\$106 | +\$165 | +\$71 |
| INBTBMPS2542 | 24" | 42" | 1/2" | \$786 | +\$83 | +\$119 | +\$183 | +\$80 |
| INBTBMPS2548 | 24" | 48" | 1/2" | \$857 | +\$90 | +\$130 | +\$200 | +\$87 |
| INBTBMPS2554 | 24" | 54" | 1/2" | \$957 | +\$100 | +\$145 | +\$223 | +\$97 |
| INBTBMPS2560 | 24" | 60" | 1/2" | \$1041 | +\$108 | +\$158 | +\$243 | +\$105 |

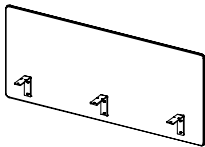

Slim Surface Mounted Tackable Screen

- Worksurface Undermount accessories are available in any of Inscape's standard paint colors
- Worksurface Undermount accessories can also be used on Inscape System and freestanding tables

NOTES

In order to get a total cost on products when upcharges are present take the list price of the product number and add the upcharge cost shown to the list price.

For example:

Product INBUMBIN in an Accent Paint would be \$235 +\$16

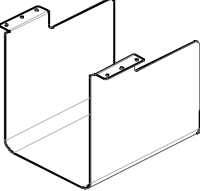
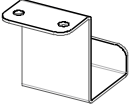

| | | Part number | H | W | D | Neutral paint/ base price | Accent paint |
|---|---|------------------|-------|------|------|------------------------------|--------------|
|  | Worksurface Undermounted Bin | INBUMBIN | 12 ½" | 9" | 12" | \$235 | +\$16 |
|  | Worksurface Undermounted Accessory Hook | INBUMHOOK | 2 ¼" | 1 ½" | 1 ½" | \$12 | +\$5 |

- For replacement parts only

NOTES

In order to get a total cost on products when upcharges are present take the list price of the product number and add the upcharge cost shown to the list price.

For example:
Product INBWMCSWSKIN in Grade D would be \$221 +\$123

| | Part number | H | W | Grade A/ COM/ base price | Grade B | Grade C | Grade D | Grade E | Grade F |
|---|---------------------|---------|---------|--------------------------------|---------|---------|---------|---------|---------|
|  <p>Replacement Fabric Skin for Corner Wood Curved Screen left and right hand compatible</p> | INBWMCSWSKIN | 16 1/8" | 51 5/8" | \$221 | +\$79 | +\$101 | +\$123 | +\$137 | +\$156 |
|  <p>Replacement Fabric Skin for Corner Metal Screen left and right hand compatible</p> | INBWMCSMSKIN | 16 1/8" | 39 1/3" | \$199 | +\$79 | +\$101 | +\$123 | +\$137 | +\$156 |

• For replacement parts only

NOTES

In order to get a total cost on products when upcharges are present take the list price of the product number and add the upcharge cost shown to the list price.

For example:

Product INBSHELFWSKIN36 in Grade D would be \$179 +\$62

| | Part number | H | W | Grade A/ COM/ base price | Grade B | Grade C | Grade D | Grade E | Grade F |
|---|---|---------|---------|--------------------------------|---------|---------|---------|---------|---------|
|  | INBSHELFWSKIN36 When shelf is used on a 36" w spine frame | 11 1/2" | 39 7/8" | \$179 | +\$43 | +\$52 | +\$62 | +\$69 | +\$81 |
| | INBSHELFWSKIN60 When shelf is used on a 60" w spine frame | 11 1/2" | 63 7/8" | \$198 | +\$43 | +\$52 | +\$62 | +\$69 | +\$81 |

Replacement Fabric Skin for Single Wood Upmount Shelf

| | | | | | | | | | |
|---|---|---------|---------|-------|-------|-------|-------|-------|-------|
|  | INBSHELFMSKIN36 When shelf is used on a 36" w spine frame | 11 5/8" | 24 1/2" | \$156 | +\$43 | +\$52 | +\$62 | +\$69 | +\$81 |
| | INBSHELFMSKIN60 When shelf is used on a 60" w spine frame | 11 5/8" | 48 1/2" | \$175 | +\$43 | +\$52 | +\$62 | +\$69 | +\$81 |

Replacement Fabric Skin for Single Metal Upmount Shelf

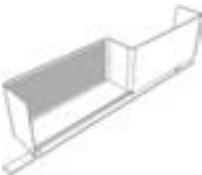
| | | | | | | | | | |
|---|--|---------|---------|-------|-------|-------|-------|-------|-------|
|  | INBSHELFMSK72 When shelf is used on a 72" w (2x 36") spine frame | 11 5/8" | 29 1/9" | \$164 | +\$31 | +\$39 | +\$48 | +\$53 | +\$60 |
|---|--|---------|---------|-------|-------|-------|-------|-------|-------|

Replacement Fabric Skin for Back to Back Metal Upmount Shelf left and right hand compatible single side replacement part

Tables

US Price List

June 2021

inscape

work for tomorrow

Tables
Tables
Collection

inscape

work for tomorrow

- Codes come complete with surfaces, legs and optional power
- Worksurfaces are 1 ¼" thick only and available in laminate, grade 1 laminate (plywood edge) and Nuform surface finishes
- When manually specifying worksurface in Laminate, add suffix "-S" to the code
- Laminate is available in straight edge only
- Nuform is available in straight or tapered edge
- Legs are angled and conical shaped with black leveling glides
- Legs are available in Clear Oak (default), Black Oak and Clear Maple finishes
- Standing Height Tables include a foot rail that is available in all standard paint colors. Accent paint colors have an upcharge.



- The Mini Tap power module has a 72" long cord and is available in black only. Module has 1 power + 1 USB.
- O Legs and foot rails are available in all standard paint colors. Accent paint colors have an upcharge.

NOTES

In order to get a total cost on products when an upcharge or downcharge is present you take the list price of the product number and add the upcharge or deduct the downcharge cost shown to the list price.

For example:

Product TCRSTA3060 in Nuform Select with a Tapered Edge and 2 power modules would be \$2503 +\$70 +\$36 +\$724

| | Part number | H | W | D | Thickness | Straight edge Nuform classic/ laminate (base) | Nuform select | Nuform tapered edge | Grade 1 laminate Straight Edge only | Power options | | | Accent paint |
|--|---------------------|-----|-----|-----|-----------|---|---------------|---------------------|-------------------------------------|---------------|----------|----------|--------------|
| | | | | | | | | | | None | 1 module | 2 module | |
|  Curved Rectangular Standing Height Table available with Mini Tap power option | TCRSTA3060 | 39" | 60" | 30" | 1 ¼" | \$2503 | +\$70 | +\$36 | +\$214 | — | +\$370 | +\$724 | +\$252 |
| | TCRSTA3072 | 39" | 72" | 30" | 1 ¼" | \$2564 | +\$85 | +\$60 | +\$254 | — | +\$370 | +\$724 | +\$259 |
| | TCRSTA3660 | 39" | 60" | 36" | 1 ¼" | \$2695 | +\$84 | +\$118 | +\$268 | — | +\$370 | +\$724 | +\$273 |
| | TCRSTA3672 | 39" | 72" | 36" | 1 ¼" | \$2825 | +\$94 | +\$129 | +\$287 | — | +\$370 | +\$724 | +\$285 |
| | TCRSTA4260 | 39" | 60" | 36" | 1 ¼" | \$2962 | +\$100 | +\$135 | +\$290 | — | +\$370 | +\$724 | +\$299 |
| | TCRSTA4272 | 39" | 72" | 42" | 1 ¼" | \$3100 | +\$104 | +\$141 | +\$304 | — | +\$370 | +\$724 | +\$313 |
|  Rectangular Standing Height Table available with Mini Tap power option | TRECSTA3060 | 39" | 60" | 30" | 1 ¼" | \$2503 | +\$70 | +\$36 | +\$214 | — | +\$370 | +\$724 | +\$252 |
| | TRECSTA3072 | 39" | 72" | 30" | 1 ¼" | \$2564 | +\$85 | +\$60 | +\$254 | — | +\$370 | +\$724 | +\$259 |
| | TRECSTA3660 | 39" | 60" | 36" | 1 ¼" | \$2695 | +\$84 | +\$118 | +\$268 | — | +\$370 | +\$724 | +\$273 |
| | TRECSTA3672 | 39" | 72" | 36" | 1 ¼" | \$2832 | +\$94 | +\$129 | +\$287 | — | +\$370 | +\$724 | +\$286 |
| | TRECSTA4260 | 39" | 60" | 42" | 1 ¼" | \$2962 | +\$100 | +\$135 | +\$290 | — | +\$370 | +\$724 | +\$299 |
| | TRECSTA4272 | 39" | 72" | 42" | 1 ¼" | \$3100 | +\$104 | +\$141 | +\$304 | — | +\$370 | +\$724 | +\$313 |
|  Rectangular Standing Height Table with O Legs available with Mini Tap power option | TMRECSTA3060 | 39" | 60" | 30" | 1 ¼" | \$1839 | +\$62 | +\$85 | +\$181 | — | +\$370 | +\$724 | +\$185 |
| | TMRECSTA3672 | 39" | 72" | 36" | 1 ¼" | \$1969 | +\$66 | +\$90 | +\$194 | — | +\$370 | +\$724 | +\$198 |

- Codes come complete with surfaces, legs and optional power
- Worksurfaces are 1 ¼" thick only and available in laminate, grade 1 laminate (plywood edge) and Nuform surface finishes
- When manually specifying worksurface in Laminate, add suffix "-S" to the code
- Laminate is available in straight edge only
- Nuform is available in straight or tapered edge
- Legs are angled and conical shaped with black leveling glides
- Legs are available in Clear Oak (default), Black Oak and Clear Maple finishes
- Standing Height Tables include a foot rail that is available in all standard paint colors. Accent paint colors have an upcharge.
- The Mini Tap power module has a 72" long cord and is available in black only. Module has 1 power + 1 USB.

NOTES

In order to get a total cost on products when an upcharge or downcharge is present you take the list price of the product number and add the upcharge or deduct the downcharge cost shown to the list price.

For example:



Product TRNDSTA36 in Nuform Select with a Tapered Edge and 2 power modules would be \$2506 +\$47 +\$25 +\$724

| Part number | H | W | D | Thickness | Straight edge Nuform classic/ laminate (base) | Nuform select | Nuform tapered edge | Grade 1 laminate Straight Edge only | Power options | | | Accent paint |
|------------------|-----|-----|-----|-----------|---|---------------|---------------------|-------------------------------------|---------------|----------|----------|--------------|
| | | | | | | | | | None | 1 module | 2 module | |
| TRNDSTA36 | 39" | 36" | 36" | 1 ¼" | \$2506 | +\$47 | +\$25 | +\$139 | — | +\$370 | +\$724 | +\$253 |
| TRNDSTA42 | 39" | 42" | 42" | 1 ¼" | \$2598 | +\$64 | +\$34 | +\$197 | — | +\$370 | +\$724 | +\$263 |
| TRNDSTA48 | 39" | 48" | 48" | 1 ¼" | \$2694 | +\$85 | +\$44 | +\$254 | — | +\$370 | +\$724 | +\$273 |





Round Standing Height Table
available with Mini Tap power option

- Codes come complete with surfaces, legs and optional power
- If power is optioned on tables with the flip up modules, the worksurfaces come with cutout(s)
- Worksurfaces are 1 ¼" thick only and available in laminate, grade 1 laminate (plywood edge) and Nuform surface finishes
- Laminate is available in straight edge only
- When manually specifying worksurface in Laminate, add suffix "-S" to the code
- Nuform is available in straight or tapered edge
- Legs are angled and conical shaped with black leveling glides
- Legs are available in Clear Oak (default), Black Oak and Clear Maple finishes
- The Flip-up power module is available in matte black, matte white and aluminium finishes. Module has 2 outlets + 1 duplex USB + 1 data port.
- The Mini Tap power module has a 72" long cord and is available in black only. Module has 1 power + 1 USB.
- 60" W and 72" W meeting tables can accommodate 1 flip-up power module only
- 84" W and 96" W meeting tables can accommodate 2 flip-up power modules only

| | Part number | H | W | D | Thickness | Straight edge Nuform classic/ laminate (base) | Nuform select | Nuform tapered edge | Grade 1 laminate Straight Edge only | Power options | | |
|---|---------------------|-------|-----|------|-----------|---|------------------|---------------------------|--|---------------|----------|----------|
| | | | | | | | | | | None | 1 module | 2 module |
|  Curved Rectangular Meeting Table available with Flip-up power option | TCRECMTG3660 | 28.5" | 60" | 36" | 1 ¼" | \$2058 | +\$84 | +\$118 | +\$251 | — | +\$502 | — |
| | TCRECMTG3672 | 28.5" | 72" | 36" | 1 ¼" | \$2116 | +\$94 | +\$129 | +\$287 | — | +\$502 | — |
| | TCRECMTG3684 | 28.5" | 84" | 36" | 1 ¼" | \$2334 | +\$115 | +\$157 | +\$351 | — | — | +\$977 |
| | TCRECMTG3696 | 28.5" | 96" | 36" | 1 ¼" | \$2433 | +\$139 | +\$191 | +\$427 | — | — | +\$977 |
| | TCRECMTG4260 | 28.5" | 60" | 42" | 1 ¼" | \$2094 | +\$93 | +\$135 | +\$282 | — | +\$502 | — |
| | TCRECMTG4272 | 28.5" | 72" | 42" | 1 ¼" | \$2157 | +\$108 | +\$162 | +\$333 | — | +\$502 | — |
| | TCRECMTG4284 | 28.5" | 84" | 42" | 1 ¼" | \$2381 | +\$132 | +\$195 | +\$404 | — | — | +\$977 |
| | TCRECMTG4296 | 28.5" | 96" | 42" | 1 ¼" | \$2484 | +\$161 | +\$235 | +\$492 | — | — | +\$977 |
| | TCRECMTG4860 | 28.5" | 60" | 48" | 1 ¼" | \$2130 | +\$105 | +\$156 | +\$322 | — | +\$502 | — |
| | TCRECMTG4872 | 28.5" | 72" | 48" | 1 ¼" | \$2198 | +\$125 | +\$185 | +\$380 | — | +\$502 | — |
| TCRECMTG4884 | 28.5" | 84" | 48" | 1 ¼" | \$2427 | +\$152 | +\$222 | +\$466 | — | — | +\$977 | |
| TCRECMTG4896 | 28.5" | 96" | 48" | 1 ¼" | \$2536 | +\$185 | +\$270 | +\$571 | — | — | +\$977 | |
|  Curved Rectangular Meeting Table available with Mini Tap power option | TCRECMTG3636 | 28.5" | 36" | 36" | 1 ¼" | \$1773 | +\$56 | +\$83 | +\$169 | — | +\$370 | +\$724 |
| | TCRECMTG4242 | 28.5" | 42" | 42" | 1 ¼" | \$1828 | +\$66 | +\$97 | +\$204 | — | +\$370 | +\$724 |
| | TCRECMTG4848 | 28.5" | 48" | 48" | 1 ¼" | \$1888 | +\$88 | +\$126 | +\$265 | — | +\$370 | +\$724 |

- Codes come complete with surfaces, legs and optional power
- If power is optioned on tables with the flip up modules, the worksurfaces come with cutout(s)
- Worksurfaces are 1 ¼" thick only and available in laminate, grade 1 laminate (plywood edge) and Nuform surface finishes
- Laminate is available in straight edge only
- When manually specifying worksurface in Laminate, add suffix "-S" to the code
- Nuform is available in straight or tapered edge
- Legs are angled and conical shaped with black leveling glides
- Legs are available in Clear Oak (default), Black Oak and Clear Maple finishes
- The Flip-up power module is available in matte black, matte white and aluminium finishes. Module has 2 outlets + 1 duplex USB + 1 data port.
- The Mini Tap power module has a 72" long cord and is available in black only. Module has 1 power + 1 USB.
- 60" W and 72" W meeting tables can accommodate 1 flip-up power module only
- 84" W and 96" W meeting tables can accommodate 2 flip-up power modules only
- O Legs and foot rails are available in all standard paint colors. Accent paint colors have an upcharge.

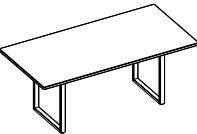
| | Part number | H | W | D | Thickness | Straight edge Nuform classic/ laminate (base) | Nuform select | Nuform tapered edge | Grade 1 laminate Straight Edge only | Power options | | |
|--|---------------------|-------|-----|------|-----------|---|------------------|---------------------------|--|---------------|----------|----------|
| | | | | | | | | | | None | 1 module | 2 module |
|  Rectangular Meeting Table available with Flip-up power option | TRECMTG3660 | 28.5" | 60" | 36" | 1 ¼" | \$2058 | +\$84 | +\$118 | +\$251 | — | +\$502 | — |
| | TRECMTG3672 | 28.5" | 72" | 36" | 1 ¼" | \$2116 | +\$94 | +\$129 | +\$287 | — | +\$502 | — |
| | TRECMTG3684 | 28.5" | 84" | 36" | 1 ¼" | \$2334 | +\$115 | +\$157 | +\$351 | — | — | +\$977 |
| | TRECMTG3696 | 28.5" | 96" | 36" | 1 ¼" | \$2433 | +\$139 | +\$191 | +\$427 | — | — | +\$977 |
| | TRECMTG4260 | 28.5" | 60" | 42" | 1 ¼" | \$2094 | +\$93 | +\$135 | +\$282 | — | +\$502 | — |
| | TRECMTG4272 | 28.5" | 72" | 42" | 1 ¼" | \$2157 | +\$108 | +\$162 | +\$333 | — | +\$502 | — |
| | TRECMTG4284 | 28.5" | 84" | 42" | 1 ¼" | \$2381 | +\$132 | +\$195 | +\$404 | — | — | +\$977 |
| | TRECMTG4296 | 28.5" | 96" | 42" | 1 ¼" | \$2484 | +\$161 | +\$235 | +\$492 | — | — | +\$977 |
| | TRECMTG4860 | 28.5" | 60" | 48" | 1 ¼" | \$2130 | +\$105 | +\$156 | +\$322 | — | +\$502 | — |
| | TRECMTG4872 | 28.5" | 72" | 48" | 1 ¼" | \$2198 | +\$125 | +\$185 | +\$380 | — | +\$502 | — |
| TRECMTG4884 | 28.5" | 84" | 48" | 1 ¼" | \$2427 | +\$152 | +\$222 | +\$466 | — | — | +\$977 | |
| TRECMTG4896 | 28.5" | 96" | 48" | 1 ¼" | \$2536 | +\$185 | +\$270 | +\$571 | — | — | +\$977 | |
|  Rectangular Meeting Table available with Mini Tap power option | TRECMTG3636 | 28.5" | 36" | 36" | 1 ¼" | \$1773 | +\$56 | +\$83 | +\$169 | — | +\$370 | +\$724 |
| | TRECMTG4242 | 28.5" | 42" | 42" | 1 ¼" | \$1828 | +\$66 | +\$97 | +\$204 | — | +\$370 | +\$724 |
| | TRECMTG4848 | 28.5" | 48" | 48" | 1 ¼" | \$1888 | +\$88 | +\$126 | +\$265 | — | +\$370 | +\$724 |
|  Rectangular Meeting Table with O Legs available with Mini Tap power option | TMRECMTG3672 | 28.5" | 72" | 36" | 1 ¼" | \$1839 | +\$62 | +\$85 | +\$181 | — | +\$502 | — |
| | TMRECMTG4284 | 28.5" | 84" | 42" | 1 ¼" | \$2081 | +\$70 | +\$96 | +\$205 | — | — | +\$977 |
| | TMRECMTG4896 | 28.5" | 96" | 48" | 1 ¼" | \$2324 | +\$78 | +\$105 | +\$228 | — | — | +\$977 |

ROUND MEETING TABLE

- Codes come complete with surfaces, legs and optional power
- Worksurfaces are 1 ¼" thick only and available in laminate, grade 1 laminate (plywood edge) and Nuform surface finishes
- Laminate is available in straight edge only
- When manually specifying worksurface in Laminate, add suffix "-S" to the code
- Nuform is available in straight or tapered edge
- Legs are angled and conical shaped with black leveling glides
- Legs are available in Clear Oak (default), Black Oak and Clear Maple finishes
- The Mini Tap power module has a 72" long cord and is available in black only. Module has 1 power + 1 USB.

COLLABORATIVE TABLE

- The table has straight fronts and backs with curved sides. It is available in 1 ¼" thick Nuform and laminate options only
- Table base is available in all paint colors

| Part number | H | W | D | Thickness | Straight edge Nuform classic/ laminate (base) | Nuform select | Nuform tapered edge | Grade 1 laminate Straight Edge only | Power options | | |
|------------------|-------|-----|-----|-----------|---|------------------|---------------------------|--|---------------|----------|----------|
| | | | | | | | | | None | 1 module | 2 module |
| TRNDMTG30 | 28.5" | 30" | 30" | 1 ¼" | \$1746 | +\$36 | +\$24 | +\$125 | — | +\$370 | +\$724 |
| TRNDMTG36 | 28.5" | 36" | 36" | 1 ¼" | \$1749 | +\$47 | +\$26 | +\$139 | — | +\$370 | +\$724 |
| TRNDMTG42 | 28.5" | 42" | 42" | 1 ¼" | \$1821 | +\$64 | +\$34 | +\$197 | — | +\$370 | +\$724 |
| TRNDMTG48 | 28.5" | 48" | 48" | 1 ¼" | \$1902 | +\$85 | +\$44 | +\$254 | — | +\$370 | +\$724 |



Round Meeting Table
available with Mini
Tap power option

| Part number | H | W | D | Nuform classic/ laminate/ base price | Nuform select | Grade 1 laminate | Accent paint |
|------------------|-----|-------|-------|--|------------------|---------------------|-----------------|
| INBCLBTBL | 26" | 33 ¾" | 29 ⅝" | \$1514 | +\$77 | +\$486 | +\$153 |



Collaborative Table

- Codes come complete with surfaces, legs and optional power
- Worksurfaces are 1 ¼" thick only and available in laminate, grade 1 laminate (plywood edge) and Nuform surface finishes
- When manually specifying worksurface in Laminate, add suffix "-S" to the code
- Laminate is available in straight edge only
- Nuform is available in straight or tapered edge
- Legs are angled and conical shaped with black leveling glides
- Legs are available in Clear Oak (default), Black Oak and Clear Maple finishes
- The Mini Tap power module has a 72" long cord and is available in black only. Module has 1 power + 1 USB.

NOTE

In order to get a total cost on products when an upcharge or downcharge is present you take the list price of the product number and add the upcharge or deduct the downcharge cost shown to the list price.

For example:

Product TCRCOF30 in Nuform Select with a Tapered Edge and 2 power modules would be \$1214 +\$45 +\$25 +\$724

| Part number | H | W | D | Thickness | Straight edge Nuform classic/ laminate (base) | Nuform select | Nuform tapered edge | Grade 1 laminate Straight Edge only | Power options | | |
|-----------------|-----|-----|-----|-----------|---|------------------|---------------------------|--|---------------|----------|----------|
| | | | | | | | | | None | 1 module | 2 module |
| TCRCOF30 | 17" | 30" | 30" | 1 ¼" | \$1214 | +\$45 | +\$25 | +\$132 | — | +\$370 | +\$724 |
| TCRCOF36 | 17" | 36" | 36" | 1 ¼" | \$1305 | +\$56 | +\$83 | +\$169 | — | +\$370 | +\$724 |
| TCRCOF42 | 17" | 42" | 42" | 1 ¼" | \$1359 | +\$66 | +\$97 | +\$204 | — | +\$370 | +\$724 |



Curved Rectangular Coffee Table

available with Mini Tap power option

| | | | | | | | | | | | |
|------------------|-----|-----|-----|------|--------|-------|-------|--------|---|--------|--------|
| TSQUCOF30 | 17" | 30" | 30" | 1 ¼" | \$1214 | +\$45 | +\$25 | +\$132 | — | +\$370 | +\$724 |
| TSQUCOF36 | 17" | 36" | 36" | 1 ¼" | \$1305 | +\$56 | +\$83 | +\$169 | — | +\$370 | +\$724 |
| TSQUCOF42 | 17" | 42" | 42" | 1 ¼" | \$1359 | +\$66 | +\$97 | +\$204 | — | +\$370 | +\$724 |



Rectangular Coffee Table

available with Mini Tap power option

| | | | | | | | | | | | |
|------------------|-----|-----|-----|------|--------|-------|-------|--------|---|--------|--------|
| TRNDCOF30 | 17" | 30" | 30" | 1 ¼" | \$1214 | +\$43 | +\$25 | +\$126 | — | +\$370 | +\$724 |
| TRNDCOF36 | 17" | 36" | 36" | 1 ¼" | \$1280 | +\$47 | +\$26 | +\$139 | — | +\$370 | +\$724 |
| TRNDCOF42 | 17" | 42" | 42" | 1 ¼" | \$1354 | +\$64 | +\$34 | +\$197 | — | +\$370 | +\$724 |



Round Coffee Table

available with Mini Tap power option

Tables Worksurfaces

inscape

work for tomorrow

Worksurfaces

Square and Rectangular Tops

Tables

- 60"-72" W rectangular tops require a stretcher bar
- 78" W and over rectangular tops require a center leg
- Tables are true to size
- When manually specifying worksurface in Laminate, add suffix "-S" to the code
- The tapered edge option on the 30" and 36" deep worksurfaces will only be on the front edge if specified
- The tapered edge option on the 42" and 48" deep worksurfaces will be on the all four sides if specified





NOTE

In order to get a total cost on products when an upcharge or downcharge is present you take the list price of the product number and add the upcharge or deduct the downcharge cost shown to the list price.

For example:

Product TW3030 in Nuform Select with a Tapered Edge would be \$393 +\$45 +\$25

Product TW3030 in Nuform Select with a 1" Straight Edge would be \$393 +\$45 -\$44

| | Part number | W | D | 1.25" Straight edge Nuform classic/laminate (base) | Nuform select | Nuform tapered edge | 1" Straight edge Nuform | Grade 1 laminate Straight Edge only |
|--|-------------|-----|--------|--|---------------|---------------------|-------------------------|-------------------------------------|
|  30" D Rectangular Top | TW3030 | 30" | 30" | \$393 | +\$45 | +\$25 | -\$44 | +\$128 |
| | TW3036 | 36" | 30" | \$448 | +\$48 | +\$26 | -\$47 | +\$144 |
| | TW3042 | 42" | 30" | \$472 | +\$51 | +\$26 | -\$50 | +\$153 |
| | TW3048 | 48" | 30" | \$538 | +\$58 | +\$31 | -\$56 | +\$173 |
| | TW3054 | 54" | 30" | \$604 | +\$63 | +\$32 | -\$61 | +\$196 |
| | TW3060 | 60" | 30" | \$674 | +\$69 | +\$34 | -\$69 | +\$216 |
| | TW3066 | 66" | 30" | \$720 | +\$73 | +\$37 | -\$73 | +\$233 |
| | TW3072 | 72" | 30" | \$807 | +\$84 | +\$42 | -\$84 | +\$259 |
| | TW3078 | 78" | 30" | \$895 | +\$91 | +\$47 | -\$90 | +\$288 |
| | TW3084 | 84" | 30" | \$980 | +\$102 | +\$52 | -\$101 | +\$316 |
| | TW3090 | 90" | 30" | \$1066 | +\$108 | +\$57 | -\$108 | +\$343 |
| TW3096 | 96" | 30" | \$1156 | +\$119 | +\$60 | -\$118 | +\$371 | |
|  36" D Rectangular Top | TW3636 | 36" | 36" | \$519 | +\$56 | +\$83 | -\$56 | +\$168 |
| | TW3642 | 42" | 36" | \$548 | +\$57 | +\$86 | -\$58 | +\$177 |
| | TW3648 | 48" | 36" | \$621 | +\$66 | +\$98 | -\$69 | +\$201 |
| | TW3654 | 54" | 36" | \$699 | +\$73 | +\$106 | -\$69 | +\$225 |
| | TW3660 | 60" | 36" | \$783 | +\$84 | +\$118 | -\$84 | +\$252 |
| | TW3666 | 66" | 36" | \$830 | +\$87 | +\$124 | -\$87 | +\$267 |
| | TW3672 | 72" | 36" | \$935 | +\$94 | +\$129 | -\$94 | +\$301 |
| | TW3678 | 78" | 36" | \$1036 | +\$103 | +\$142 | -\$101 | +\$332 |
| | TW3684 | 84" | 36" | \$1138 | +\$115 | +\$157 | -\$111 | +\$366 |
| | TW3690 | 90" | 36" | \$1251 | +\$128 | +\$173 | -\$121 | +\$402 |
| | TW3696 | 96" | 36" | \$1374 | +\$139 | +\$191 | -\$132 | +\$441 |
|  42" D Rectangular Top | TW4242 | 42" | 42" | \$639 | +\$66 | +\$97 | — | +\$206 |
| | TW4260 | 60" | 42" | \$909 | +\$93 | +\$135 | — | +\$292 |
| | TW4272 | 72" | 42" | \$1083 | +\$108 | +\$162 | — | +\$348 |
| | TW4284 | 84" | 42" | \$1306 | +\$132 | +\$195 | — | +\$420 |
| | TW4296 | 96" | 42" | \$1577 | +\$161 | +\$235 | — | +\$506 |
|  48" D Rectangular Top | TW4848 | 48" | 48" | \$831 | +\$88 | +\$126 | — | +\$267 |
| | TW4860 | 60" | 48" | \$1044 | +\$105 | +\$156 | — | +\$334 |
| | TW4872 | 72" | 48" | \$1244 | +\$125 | +\$185 | — | +\$399 |
| | TW4884 | 84" | 48" | \$1502 | +\$152 | +\$222 | — | +\$481 |
| | TW4896 | 96" | 48" | \$1811 | +\$185 | +\$270 | — | +\$582 |





- Racetrack Tops for use with 2 cylindrical table bases
- Bases are not included. See Legs and Bases section
- Tables are true to size
- When manually specifying worksurface in Laminate, add suffix “-S” to the code
- Stretcher bars are required for unsupported worksurfaces of 54" W or wider

NOTE

In order to get a total cost on products when an upcharge or downcharge is present you take the list price of the product number and add the upcharge or deduct the downcharge cost shown to the list price.

For example:

Product TWRT3672 in Nuform Select with a Tapered Edge would be \$989 +\$99 +\$134

| | Part number | W | D | 1.25" Straight edge Nuform classic/laminate (base) | Nuform select | Nuform tapered edge | 1" Straight edge Nuform | Grade 1 laminate Straight Edge only |
|---|-----------------|-----|-----|--|---------------|---------------------|-------------------------|-------------------------------------|
|  | TWRT3672 | 72" | 36" | \$989 | +\$99 | +\$134 | — | +\$318 |
| | TWRT4284 | 84" | 42" | \$1372 | +\$138 | +\$205 | — | +\$441 |
| | TWRT4896 | 96" | 48" | \$1900 | +\$195 | +\$282 | — | +\$610 |
| Racetrack Top For use with 2 cylindrical table bases | | | | | | | | |
|  | TWBT3672 | 72" | 36" | \$989 | +\$99 | +\$134 | — | +\$318 |
| | | | | | | | | |
| 36" D Boat Top | | | | | | | | |
|  | TWBT4284 | 84" | 42" | \$1372 | +\$138 | +\$205 | — | +\$441 |
| | TWBT4296 | 96" | 42" | \$1656 | +\$168 | +\$247 | — | +\$532 |
| 42" D Boat Top | | | | | | | | |
|  | TWBT4884 | 84" | 48" | \$1576 | +\$160 | +\$282 | — | +\$506 |
| | TWBT4896 | 96" | 48" | \$1900 | +\$2056 | +\$2144 | — | +\$610 |
| 48" D Boat Top | | | | | | | | |

- Tables are true to size
- When manually specifying worksurface in Laminate, add suffix “-S” to the code





NOTE

In order to get a total cost on products when an upcharge or downcharge is present you take the list price of the product number and add the upcharge or deduct the downcharge cost shown to the list price.

For example:

Product TWRND30 in Nuform Select with a Tapered Edge would be \$431 +\$43 +\$25

Product TWRND30 in Nuform Select with a 1" Straight Edge would be \$431 +\$43 -\$25

| | Part number | W | D | 1.25" Straight edge Nuform classic/laminate (base) | Nuform select | Nuform tapered edge | 1" Straight edge Nuform | Grade 1 laminate Straight Edge only |
|--|----------------|-----|-----|--|---------------|---------------------|-------------------------|-------------------------------------|
|  30" D Round Top | TWRND30 | 30" | 30" | \$431 | +\$43 | +\$25 | -\$25 | +\$139 |
|  36" D Round Top | TWRND36 | 36" | 36" | \$474 | +\$47 | +\$26 | -\$27 | +\$153 |
|  42" D Round Top | TWRND42 | 42" | 42" | \$658 | +\$64 | +\$34 | -\$34 | +\$212 |
|  48" D Round Top | TWRND48 | 48" | 48" | \$829 | +\$85 | +\$44 | -\$44 | +\$267 |

- Requires 2 legs and 2 flush brackets
- Legs and brackets are not included. See Legs and Bases section
- Tables are true to size
- Grain direction runs from straight edge towards arc on the 42" W and 48" W surfaces
- Grain direction runs from side to side on the 60" W and 72" W surfaces
- When manually specifying worksurface in Laminate, add suffix "-S" to the code
- Stretcher bars are required for unsupported worksurfaces of 54" W or wider

NOTE

In order to get a total cost on products when an upcharge or downcharge is present you take the list price of the product number and add the upcharge or deduct the downcharge cost shown to the list price.

For example:

Product TWSC4221 in Nuform Select with a Tapered Edge would be \$475 +\$54 +\$30

Product TWSC4221 in Nuform Select with a 1" Straight Edge would be \$475 +\$54 -\$52

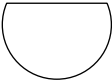
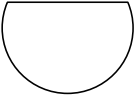
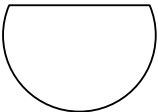
| | Part number | W | D | 1.25" Straight edge Nuform classic/laminate (base) | Nuform select | Nuform tapered edge | 1" Straight edge Nuform | Grade 1 laminate Straight Edge only |
|--|-----------------|-----|-----|--|---------------|---------------------|-------------------------|-------------------------------------|
|  42" W Semi-circle Top | TWSC4221 | 42" | 21" | \$475 | +\$54 | +\$30 | -\$52 | +\$154 |
|  48" W Semi-circle Top | TWSC4824 | 48" | 24" | \$591 | +\$63 | +\$32 | -\$63 | +\$191 |
|  60" W Semi-circle Top | TWSC6030 | 60" | 30" | \$823 | +\$86 | +\$42 | -\$85 | +\$265 |
|  72" W Semi-circle Top | TWSC7236 | 72" | 36" | \$1053 | +\$104 | +\$48 | -\$102 | +\$339 |

- Requires one post leg and 2 flush mount brackets
- Legs and brackets are not included. See Legs and Bases section
- Tables are true to size
- When manually specifying worksurface in Laminate, add suffix "-S" to the code



NOTE

In order to get a total cost on products when an upcharge or downcharge is present you take the list price of the product number and add the upcharge or deduct the downcharge cost shown to the list price.

For example:

Product TWQC30 in Nuform Select with a Tapered Edge would be \$413 +\$44 +\$22

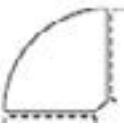
Product TWQC30 in Nuform Select with a 1" Straight Edge would be \$413 +\$44 -\$43

| | Part number | W | D | 1.25" Straight edge Nuform classic/laminate (base) | Nuform select | Nuform tapered edge | 1" Straight edge Nuform | Grade 1 laminate Straight Edge only |
|---|---------------|-----|-----|--|---------------|---------------------|-------------------------|-------------------------------------|
|  30" D Quarter-circle Top | TWQC30 | 30" | 30" | \$413 | +\$44 | +\$22 | -\$43 | +\$133 |
|  36" D Quarter-circle Top | TWQC36 | 36" | 36" | \$529 | +\$54 | +\$26 | -\$52 | +\$171 |



- Tables are true to size
- When manually specifying worksurface in Laminate, add suffix “-S” to the code
- Stretcher bars are required for unsupported worksurfaces of 54" W or wider

NOTE

In order to get a total cost on products when an upcharge or downcharge is present you take the list price of the product number and add the upcharge or deduct the downcharge cost shown to the list price.

For example:

Product TWTRAP3060 in Nuform Select with a 1" Straight Edge would be \$738 +\$74 -\$73

| | Part number | W | D | 1.25" Straight edge Nuform classic/laminate (base) | Nuform select | Nuform tapered edge | 1" Straight edge Nuform | Grade 1 laminate Straight Edge only |
|---|-------------------|-----|---|--|---------------|---------------------|-------------------------|-------------------------------------|
|  Trapezoid Top 30"x30"x60" | TWTRAP3060 | 60" | — | \$738 | +\$74 | — | -\$73 | +\$238 |
|  Trapezoid Top 24"x24"x48" | TWTRAP2448 | 48" | — | \$556 | +\$57 | — | -\$57 | +\$179 |

Worksurfaces

Hex, Pebble and Rhombus Tops

Tables





- Tables are true to size
- Not available in tapered edge
- Stretcher bars are required for unsupported worksurfaces of 54" W or wider
- When manually specifying worksurface in Laminate, add suffix "-S" to the code
- Pebble Top for use with 1 cylindrical table base only
- Rhombus Top for use with 2 cylindrical table bases only

NOTE

In order to get a total cost on products when an upcharge or downcharge is present you take the list price of the product number and add the upcharge or deduct the downcharge cost shown to the list price.

For example:

Product TWHEXL3072 in Nuform Select with a 1" Straight Edge would be \$882 +\$90 -\$89

| | Part number | W | D | 1.25" Straight edge Nuform classic/ laminate (base) | Nuform select | Nuform tapered edge | 1" Straight edge Nuform |
|---|-----------------------------------|-----|-----|---|------------------|---------------------------|----------------------------|
|  | TWHEXL3072 left-handed | 72" | 30" | \$882 | +\$90 | — | -\$89 |
| Hex Top | | | | | | | |
|  | TWHEXR3072 right-handed | 72" | 30" | \$882 | +\$90 | — | -\$89 |
| Hex Top | | | | | | | |
|  | TWPEB3648 | 48" | 36" | \$871 | +\$88 | — | -\$46 |
| Pebble Top | | | | | | | |
|  | TWROM4890 | 90" | 48" | \$1900 | +\$195 | — | -\$183 |
| Rhombus Top | | | | | | | |

Worksurfaces

Rectangular Tops with Power Module

Tables





- 60" & 72" W rectangular tops require a stretcher bar
- 78" W and over rectangular tops require a center leg
- 30" & 36" deep surfaces include power modules positioned 2" in from the back edge. 60" and 72" W have one module and 84" & 96" have two modules
- 42" & 48" deep surfaces include power modules centered front to back. 60" & 72" W have one module and 84" and 96" have two modules
- When manually specifying worksurface in Laminate, add suffix "-S" to the code
- Stretcher bars are required for unsupported worksurfaces of 54" W or wider
- Rectangular Tops with Flip Up Power Module are not available in Nuform

NOTES

In order to get a total cost on products when an upcharge or downcharge is present you take the list price of the product number and add the upcharge or deduct the downcharge cost shown to the list price.

For example:

Product TWP3060-S in Grade 1 laminate would be \$1583 +\$508

| | Part number | W | D | 1.25" Straight edge Nuform classic/laminate (base) | Nuform select | Nuform tapered edge | 1" Straight edge Nuform | Grade 1 laminate Straight Edge only |
|--|------------------|-----|-----|--|---------------|---------------------|-------------------------|-------------------------------------|
|  30" D Rectangular Top with power module | TWP3060-S | 60" | 30" | \$1583 | — | — | — | +\$508 |
| | TWP3072-S | 72" | 30" | \$1714 | — | — | — | +\$550 |
| | TWP3084-S | 84" | 30" | \$1888 | — | — | — | +\$606 |
| | TWP3096-S | 96" | 30" | \$2063 | — | — | — | +\$661 |
|  36" D Rectangular Top with power module | TWP3660-S | 60" | 36" | \$1691 | — | — | — | +\$543 |
| | TWP3672-S | 72" | 36" | \$1841 | — | — | — | +\$590 |
| | TWP3684-S | 84" | 36" | \$2037 | — | — | — | +\$654 |
| | TWP3696-S | 96" | 36" | \$2273 | — | — | — | +\$729 |
|  42" D Rectangular Top with power module | TWP4260-S | 60" | 42" | \$1807 | — | — | — | +\$580 |
| | TWP4272-S | 72" | 42" | \$1981 | — | — | — | +\$636 |
| | TWP4284-S | 84" | 42" | \$2205 | — | — | — | +\$708 |
| | TWP4296-S | 96" | 42" | \$2475 | — | — | — | +\$793 |
|  48" D Rectangular Top with power module | TWP4860-S | 60" | 48" | \$1942 | — | — | — | +\$624 |
| | TWP4872-S | 72" | 48" | \$2142 | — | — | — | +\$686 |
| | TWP4884-S | 84" | 48" | \$2398 | — | — | — | +\$769 |
| | TWP4896-S | 96" | 48" | \$2709 | — | — | — | +\$869 |

Worksurfaces

Bullet, Bean, Oval and Curved Rectangular Tops

Tables

- Stretcher bars are required for unsupported worksurfaces of 54" W or wider
- When manually specifying worksurface in Laminate, add suffix "-S" to the code





NOTES

In order to get a total cost on products when an upcharge or downcharge is present you take the list price of the product number and add the upcharge or deduct the downcharge cost shown to the list price.

For example:

Product TCTB2460 in Nuform Select would be \$658 +\$70

Product TCTB2460 in Nuform Select with a 1" Straight Edge would be \$658 +\$70 -\$67



| | Part number | W | D | 1.25" Straight edge Nuform classic/laminate (base) | Nuform select | Nuform tapered edge | 1" Straight edge Nuform | Grade 1 laminate Straight Edge only |
|---|------------------|---------|-----|--|---------------|---------------------|-------------------------|-------------------------------------|
|  Bullet Top | TCTB2460 | 60" | 24" | \$658 | +\$70 | — | -\$67 | +\$212 |
| | TCTB2466 | 66" | 24" | \$722 | +\$73 | — | -\$73 | +\$234 |
| | TCTB2472 | 72" | 24" | \$788 | +\$86 | — | -\$85 | +\$253 |
| | TCTB3060 | 60" | 30" | \$822 | +\$89 | — | -\$88 | +\$265 |
| | TCTB3066 | 66" | 30" | \$875 | +\$91 | — | -\$90 | +\$282 |
| | TCTB3072 | 72" | 30" | \$984 | +\$102 | — | -\$101 | +\$317 |
|  Bean Top | TB2748 | 48" | 27" | \$493 | +\$70 | — | -\$67 | +\$160 |
|  Oval Top | TOM3048 | 48" | 30" | \$658 | +\$70 | — | -\$67 | +\$212 |
|  Curved Rectangular Top | TCUR27405 | 40 1/2" | 27" | \$463 | +\$50 | — | -\$48 | +\$148 |

Tables Legs & Bases



inscape

work for tomorrow



- Height adjustable leg provides manual adjustability to five heights -25.5", 27", 28.5", 30", 31.5"
- Legs are available in any of Inscape's standard paint colors. Accent paint colors have an upcharge.
- To adjust the height there are two bolts that unthread and then pull out so that inner leg can then move up or down
- Round caster legs recommended to be used 2 with a brake and 2 without

| | | Part number | H | D | Wt (lbs) | Neutral paint/ base price | Accent paint |
|---|-------------------------|----------------------|-------|-----|----------|------------------------------|-----------------|
|  | "H" Leg Fixed Height | THLEG2428.5 | 28 ½" | 24" | — | \$485 | +\$51 |
| | | THLEG3028.5 | 28 ½" | 30" | — | \$511 | +\$53 |
| | | THLEG3628.5 | 28 ½" | 36" | — | \$529 | +\$56 |
|  | "O" Leg Fixed Height | TOLEG2428.5 | 28 ½" | 24" | — | \$403 | +\$44 |
| | | TOLEG3028.5 | 28 ½" | 30" | — | \$416 | +\$45 |
| | | TOLEG3628.5 | 28 ½" | 36" | — | \$421 | +\$45 |
|  | Round Caster Leg | TRNDLEGCASTER | 28 ½" | — | — | \$250 | +\$27 |

- Height adjustable leg provides manual adjustability to five heights -25.5", 27", 28.5", 30", 31.5"
- Legs are available in any of Inscape's standard paint colors. Accent paint colors have an upcharge.

| | | Part number | H | D | Wt (lbs) | Neutral paint/ base price | Accent paint |
|---|---|---|-------|---|----------|------------------------------|-----------------|
|  | Post Leg Visual to match Height Adjustable Table launched June 2017 | INPLAK28.5 | 28 ½" | — | — | \$300 | +\$32 |
|  | Freestanding "C" Leg for 24"D worksurfaces Visual to match Height Adjustable Table launched June 2017 | INLAKFLEG24LH left hand (illustrated) | 28 ½" | — | — | \$347 | +\$36 |
| | | INLAKFLEG24RH right hand | 28 ½" | — | — | \$347 | +\$36 |
|  | Freestanding "C" Leg for 30"D worksurfaces Visual to match Height Adjustable Table launched June 2017 | INLAKFLEG30LH left hand (illustrated) | 28 ½" | — | — | \$353 | +\$37 |
| | | INLAKFLEG30RH right hand | 28 ½" | — | — | \$353 | +\$37 |

- Height adjustable leg provides manual adjustability to five heights -25.5", 27", 28.5", 30", 31.5"
- Legs are available in any of Inscape's standard paint colors

| | | Part number | H | D | Wt (lbs) | Neutral paint/ base price | Accent paint |
|---|--|----------------------|-------|---|----------|------------------------------|-----------------|
|  | Post Leg Fixed Height With black slide glide | TLEG28.5F | 28 ½" | — | 3 | \$192 | +\$22 |
|  | Triangular Leg | TWMLEG-28.5 | 28 ½" | — | — | \$258 | +\$27 |
|  | Rectangular Post Leg Fixed Height | TRECPLEG-28.5 | 28 ½" | — | — | \$167 | +\$20 |

- Legs available in any of Inscape's standard paint colors (except cylindrical table base). Accent paint colors have an upcharge.
- Limited color options with Cylindrical Table Base
- Base only
- Cylindrical Table bases only for use with Round, Pebble, Racetrack and Rhombus Tops
- 2 Cylindrical Table bases required for Racetrack and Rhombus Tops

| | Part number | H | Wt (lbs) | Neutral paint/ base price | Accent paint |
|--|---|---|----------|------------------------------|--------------|
|  <p>"X" Table Base Top specified separately</p> | TX-BASE30 For use with 30" and 36" W Round tops only | — | — | \$1282 | +\$131 |
| | TX-BASE36 For use with 42" and 48" W Round tops only | — | — | \$1321 | +\$134 |



| | Part number | H | White/ base price | Silver |
|---|--------------------|-------|----------------------|--------|
|  <p>Cylindrical Table Base Available in white & silver only Top specified separately</p> | TCBASE-20 | 20" | \$1955 | \$20 |
| | TCBASE-28.5 | 28 ½" | \$1978 | \$21 |
| | TCBASE-42 | 42" | \$2010 | \$23 |

Tables Accessories

inscape

work for tomorrow

- Link bracket is specified to link two tables together
- Stretcher bars are required to be specified with worksurfaces 54" and wider which do have any mid support
- Stretcher bars are 1 ½" H

| | | Part number | Wt (lbs) | List price |
|---|---------------------------|---------------|----------|------------|
|  | Table Link Bracket | LBRKT | — | \$74 |
|  | Flush Bracket Kit of 2 | INFB | 0.2 | \$18 |
|  | 20" Flush Bracket | INFB20 | 1 | \$26 |

| | | Part number | W | Wt (lbs) | Eco black | Painted | |
|---|---|--------------------------|-----|----------|-----------|---------|--|
|  | Worksurface Stretcher Bar For use with worksurfaces 54" and wider | INSBK54 | 44" | — | \$77 | — | |
| | | For use with 54" surface | | | | | |
| | | INSBK60 | 50" | — | \$114 | — | |
| | | For use with 60" surface | | | | | |
| | | INSBK72 | 62" | — | \$135 | — | |
| For use with 72" surface | | | | | | | |
| | | INSBK84 | 74" | — | \$162 | — | |
| For use with 84" surface | | | | | | | |
| | | INSBK96 | 86" | — | \$183 | — | |
| For use with 96" surface | | | | | | | |

- Table mounted screens mount to worksurfaces
- Adjustable Framed Table Mounted Screens have height adjustment for above worksurface privacy and below the worksurface modesty. It is recommended that this screen be installed with a max of 20" above the surface.
- Table Mounted Screen/Modesty has 14" of the tackboard mounted above the surface and 13 ½" below
- Table Mounted Acrylic Screens have approx. 16" of screen above the surface and approx. 3" below the surface
- Freestanding Table Screen is made of 6mm thick frosted acrylic which is 13" H, seated in a painted aluminum extrusion, which can be painted any of Inscape's standard colors. This screen is 5" less in depth than depth of worksurface it will be placed on

NOTES

In order to get a total cost on products when upcharges are present take the list price of the product number and add the upcharge cost shown to the list price.

For example:

Product TMST3736 in Grade 3 Fabric would be \$607 +\$90

Product TSWTMS48 in Frosted Acrylic would be \$867 +\$103

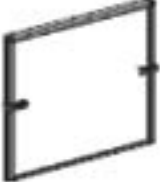
| Part number | H | D | Wt (lbs) | Grade 1/ base price | Grade 2 | Grade 3 | Grade 4 | Grade 5 | Grade 6 | Grade 7 | Grade 8 | Accent paint |
|---|-----|-----|----------|------------------------|---------|---------|---------|---------|---------|---------|---------|-----------------|
|  TMST3736 | 37" | 36" | 13 | \$607 | +\$58 | +\$90 | — | +\$156 | +\$289 | +\$426 | — | +\$63 |
| TMST3742 | 37" | 42" | 15 | \$633 | +\$59 | +\$91 | — | +\$156 | +\$293 | +\$430 | — | +\$65 |
| TMST3748 | 37" | 48" | 16 | \$658 | +\$64 | +\$92 | — | +\$157 | +\$296 | +\$435 | — | +\$67 |
| TMST3754 | 37" | 54" | 18 | \$681 | +\$66 | +\$98 | — | +\$160 | +\$305 | +\$444 | — | +\$70 |
| TMST3760 | 37" | 60" | 19 | \$705 | +\$72 | +\$103 | — | +\$160 | +\$312 | +\$455 | — | +\$72 |

37" H Adjustable Framed
Table Mounted Screen
Tackable



| Part number | H | W | Grade A/ base price | Grade B/ COM | Grade C | Grade D | Grade E | Grade F | Accent paint |
|---|-----|-----|------------------------|-----------------|---------|---------|---------|---------|-----------------|
|  INTMSF2948 | 29" | 48" | \$1281 | +\$182 | +\$499 | +\$967 | +\$1165 | +\$1590 | +\$130 |
| INTMSF2954 | 29" | 54" | \$1300 | +\$354 | +\$691 | +\$1170 | +\$1394 | +\$1956 | +\$132 |
| INTMSF2960 | 29" | 60" | \$1387 | +\$405 | +\$781 | +\$1306 | +\$1555 | +\$2175 | +\$141 |

Table Mounted
Screen/Modesty
Tackable

| Part number | H | D | Wt (lbs) | Clear acrylic | White acrylic | Frosted acrylic |
|---|-----|-----|----------|------------------|------------------|--------------------|
|  Table Mounted Acrylic Screen TSWTMS48 | 20" | 48" | 4 | \$867 | +\$103 | +\$103 |
| TSWTMS54 | 20" | 54" | 5 | \$1359 | +\$214 | +\$214 |
| TSWTMS60 | 20" | 60" | 6 | \$1575 | +\$213 | +\$213 |

| Part number | H | D | Wt (lbs) | Neutral paint/ base price | Accent paint |
|---|-----|-----|----------|------------------------------|-----------------|
|  Freestanding Table Screen TINSPS24 | 13" | 19" | 2 | \$121 | +\$16 |
| TINSPS30 | 13" | 25" | 2 | \$169 | +\$20 |
| TINSPS32 | 13" | 28" | 2 | \$177 | +\$20 |
| TINSPS36 | 13" | 31" | 2 | \$183 | +\$21 |

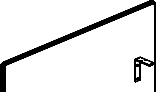
- Modesty panels are available in a variety of materials and mounting options correspond with each variety
- Modesty panels mount to the underside of worksurface and are field installed
- See Application Guide for specific dimension detailed applications
- All hardware included
- Specify modesty panels 12" shorter then the surface length when being used with a Height Adjustable Table

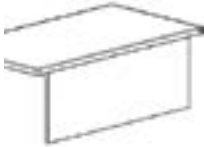
| | Part number | H | W | Neutral paint/ base price | Accent paint | |
|---|--------------------------------------|-----------------|-------|------------------------------|-----------------|-------|
|  | Painted Partial Height Modesty Panel | TMDPNP30 | 13.5" | 30" | \$135 | +\$17 |
| | | TMDPNP33 | 13.5" | 33" | \$139 | +\$17 |
| | | TMDPNP36 | 13.5" | 36" | \$141 | +\$17 |
| | | TMDPNP39 | 13.5" | 39" | \$144 | +\$18 |
| | | TMDPNP42 | 13.5" | 42" | \$147 | +\$18 |
| | | TMDPNP45 | 13.5" | 45" | \$152 | +\$18 |
| | | TMDPNP48 | 13.5" | 48" | \$159 | +\$19 |
| | | TMDPNP51 | 13.5" | 51" | \$161 | +\$19 |
| | | TMDPNP54 | 13.5" | 54" | \$164 | +\$19 |
| | | TMDPNP57 | 13.5" | 57" | \$167 | +\$20 |
| | | TMDPNP60 | 13.5" | 60" | \$169 | +\$20 |
| | | TMDPNP63 | 13.5" | 63" | \$171 | +\$20 |
| | | TMDPNP66 | 13.5" | 66" | \$173 | +\$20 |
| | | TMDPNP69 | 13.5" | 69" | \$174 | +\$20 |
| | | TMDPNP72 | 13.5" | 72" | \$178 | +\$21 |

- Modesty panels are available in a variety of materials and mounting options correspond with each variety
- Modesty panels mount to the underside of worksurface and are field installed
- See Application Guide for specific dimension detailed applications
- All hardware included
- Specify modesty panels 12" shorter then the surface length when being used with a Height Adjustable Table
- The Nuform option has a gray backer
- The laminate option is laminate on both sides with a self edge

NOTES

In order to get a total cost on products when upcharges are present take the list price of the product number and add the upcharge cost shown to the list price.

For example:

Product TMDPNW30 in Grade 1 laminate would be \$312 +\$101

| | Part number | H | W | Nuform classic/ laminate/base price | Nuform select | Grade 1 laminate | Accent paint |
|---|-----------------|-------|-------|--|---------------|------------------|--------------|
|  <p>Wood Core Partial Height Modesty Panel</p> | TMDPNW30 | 13.5" | 30" | \$312 | +\$35 | +\$101 | +\$33 |
| | TMDPNW33 | 13.5" | 33" | \$333 | +\$37 | +\$107 | +\$35 |
| | TMDPNW36 | 13.5" | 36" | \$342 | +\$39 | +\$111 | +\$36 |
| | TMDPNW39 | 13.5" | 39" | \$382 | +\$44 | +\$125 | +\$42 |
| | TMDPNW42 | 13.5" | 42" | \$389 | +\$45 | +\$127 | +\$43 |
| | TMDPNW45 | 13.5" | 45" | \$399 | +\$46 | +\$130 | +\$44 |
| | TMDPNW48 | 13.5" | 48" | \$405 | +\$47 | +\$131 | +\$44 |
| | TMDPNW51 | 13.5" | 51" | \$444 | +\$50 | +\$143 | +\$48 |
| | TMDPNW54 | 13.5" | 54" | \$452 | +\$51 | +\$145 | +\$48 |
| | TMDPNW57 | 13.5" | 57" | \$463 | +\$52 | +\$148 | +\$49 |
| | TMDPNW60 | 13.5" | 60" | \$485 | +\$54 | +\$158 | +\$51 |
| | TMDPNW63 | 13.5" | 63" | \$566 | +\$63 | +\$182 | +\$59 |
| | TMDPNW66 | 13.5" | 66" | \$590 | +\$66 | +\$191 | +\$61 |
| | TMDPNW69 | 13.5" | 69" | \$612 | +\$69 | +\$198 | +\$63 |
| | TMDPNW72 | 13.5" | 72" | \$637 | +\$71 | +\$206 | +\$65 |
| | TMDPNW75 | 13.5" | 75" | \$709 | \$709 | +\$228 | +\$72 |
| | TMDPNW78 | 13.5" | 78" | \$714 | +\$80 | +\$231 | +\$73 |
| | TMDPNW81 | 13.5" | 81" | \$722 | +\$81 | +\$234 | +\$73 |
| | TMDPNW84 | 13.5" | 84" | \$726 | +\$81 | +\$235 | +\$74 |
| TMDPNW87 | 13.5" | 87" | \$733 | +\$83 | +\$237 | +\$74 | |
| TMDPNW90 | 13.5" | 90" | \$737 | +\$83 | +\$238 | +\$76 | |

- Modesty panels are available in a variety of materials and mounting options correspond with each variety
- Modesty panels mount to the underside of worksurface and are field installed
- See Application Guide for specific dimension detailed applications
- All hardware included
- Specify modesty panels 12" shorter then the surface length when being used with a Height Adjustable Table

| | Part number | H | W | Neutral paint/ base price | Accent paint |
|---|-----------------|-------|-------|------------------------------|-----------------|
|  <p>Acrylic Partial Height Modesty Panel</p> | TMDPNA30 | 13.5" | 30" | \$510 | — |
| | TMDPNA33 | 13.5" | 33" | \$515 | — |
| | TMDPNA36 | 13.5" | 36" | \$523 | — |
| | TMDPNA39 | 13.5" | 39" | \$529 | — |
| | TMDPNA42 | 13.5" | 42" | \$535 | — |
| | TMDPNA45 | 13.5" | 45" | \$547 | — |
| | TMDPNA48 | 13.5" | 48" | \$552 | — |
| | TMDPNA51 | 13.5" | 51" | \$576 | — |
| | TMDPNA54 | 13.5" | 54" | \$602 | — |
| | TMDPNA57 | 13.5" | 57" | \$625 | — |
| | TMDPNA60 | 13.5" | 60" | \$657 | — |
| | TMDPNA63 | 13.5" | 63" | \$686 | — |
| | TMDPNA66 | 13.5" | 66" | \$720 | — |
| | TMDPNA69 | 13.5" | 69" | \$749 | — |
| | TMDPNA72 | 13.5" | 72" | \$782 | — |
| | TMDPNA75 | 13.5" | 75" | \$796 | — |
| | TMDPNA78 | 13.5" | 78" | \$815 | — |
| | TMDPNA81 | 13.5" | 81" | \$831 | — |
| | TMDPNA84 | 13.5" | 84" | \$849 | — |
| TMDPNA87 | 13.5" | 87" | \$867 | — | |
| TMDPNA90 | 13.5" | 90" | \$885 | — | |

- Modesty panels are available in a variety of materials and mounting options correspond with each variety
- Modesty panels mount to the underside of worksurface and are field installed
- See Application Guide for specific dimension detailed applications
- All hardware included
- Specify modesty panels 12" shorter then the surface length when being used with a Height Adjustable Table
- The Nuform option has a gray backer
- The laminate option is laminate on both sides with a self edge
- Nuform finish is on one side with white backer

NOTES







In order to get a total cost on products when upcharges are present take the list price of the product number and add the upcharge cost shown to the list price.

For example:



Product TMDFHPNW30 in Grade 1 laminate would be \$401 +\$130

| | Part number | H | W | Nuform classic/ laminate/base price | Nuform select | Grade 1 laminate | Accent paint |
|--|-------------------|-----|-------|---|------------------|---------------------|-----------------|
|  <p>Wood Core Full Height Modesty Panel</p> | TMDFHPNW30 | 24" | 30" | \$401 | +\$46 | +\$130 | +\$44 |
| | TMDFHPNW33 | 24" | 33" | \$437 | +\$50 | +\$141 | +\$47 |
| | TMDFHPNW36 | 24" | 36" | \$445 | +\$50 | +\$144 | +\$48 |
| | TMDFHPNW39 | 24" | 39" | \$509 | +\$58 | +\$165 | +\$53 |
| | TMDFHPNW42 | 24" | 42" | \$519 | +\$59 | +\$168 | +\$54 |
| | TMDFHPNW45 | 24" | 45" | \$465 | +\$52 | +\$151 | +\$49 |
| | TMDFHPNW48 | 24" | 48" | \$540 | +\$61 | +\$174 | +\$57 |
| | TMDFHPNW51 | 24" | 51" | \$668 | +\$74 | +\$215 | +\$69 |
| | TMDFHPNW54 | 24" | 54" | \$680 | +\$77 | +\$219 | +\$70 |
| | TMDFHPNW57 | 24" | 57" | \$688 | +\$77 | +\$221 | +\$71 |
| | TMDFHPNW60 | 24" | 60" | \$708 | +\$79 | +\$228 | +\$72 |
| | TMDFHPNW63 | 24" | 63" | \$737 | +\$83 | +\$238 | +\$76 |
| | TMDFHPNW66 | 24" | 66" | \$756 | +\$85 | +\$243 | +\$77 |
| | TMDFHPNW69 | 24" | 69" | \$778 | +\$87 | +\$250 | +\$81 |
| | TMDFHPNW72 | 24" | 72" | \$793 | +\$89 | +\$255 | +\$83 |
| | TMDFHPNW75 | 24" | 75" | \$906 | +\$101 | +\$291 | +\$93 |
| | TMDFHPNW78 | 24" | 78" | \$912 | +\$102 | +\$293 | +\$94 |
| | TMDFHPNW81 | 24" | 81" | \$917 | +\$102 | +\$294 | +\$94 |
| | TMDFHPNW84 | 24" | 84" | \$924 | +\$103 | +\$296 | +\$96 |
| TMDFHPNW87 | 24" | 87" | \$929 | +\$103 | +\$299 | +\$96 | |
| TMDFHPNW90 | 24" | 90" | \$939 | +\$104 | +\$302 | +\$97 | |

- Grommets must be field installed
- Round Grommet = 2" diameter
- Rectangular Grommet = 3" x 5.25"
- Power Modules mount to the back edge of a surface and are accessible by the user above the surface
- Power Modules plug into the duplexes
- The Clamp-On Power Module is available in a black or white finish. It has a 96" long power cord and LED surge protection indication. It attaches to 1" and 1 ¼" thick worksurfaces and the mount includes a device holder.
- The Clamp-On Power Module with Colored Components comes in many different configurations with receptacles, USB (1 type A and 1 type B) ports and availability lights. Power Modules come in black, white or gray and have colored options for the lid; Black, White, Teal, Red, Purple, Blue, Green, Gray. The availability light is user controlled and requires free software download.
- All electrical components on this page are field installed

| | Part number | Dimensions | List/ base price | Black | White | Silver | Stainless steel |
|---|-----------------------|------------|---------------------|-------|-------|--------|--------------------|
|  | PLNGRKIT | 5 ¼" | \$208 | +\$0 | — | — | +\$85 |
|  | GROMMET-WS | — | \$18 | +\$0 | — | — | — |
| | Part number | | | | | | List price |
|  | INPMOD-3P1U | | | | | | \$173 |
|  | INBPMOD-1P1U | | | | | | \$437 |
|  | INBPMOD-2P1U1O | | | | | | \$548 |
|  | INBPMOD-2P1U1L | | | | | | \$867 |

- Flip-up Power & Data Module is finished with a clear anodized aluminum with white inserts and a 72" long power cord
- Mini Tap and Flip-up Module include clips and screws for basic wire management
- All electrical components on this page are field installed when specified separately from a table

| | | Part number | H | W | D | Wt (lbs) | List price |
|---|---|--|---|---|---|----------|------------|
|  | Flip-up Power & Data Module 2 outlets + 1 dual USB + 1 data finished in aluminium with white insert | PVDMODFL | — | — | — | — | \$902 |
|  | Mini Tap Undermount Power Module available in black only | PVDMODSMT-1P1U Single Configuration: 1 Power + 1 USB | — | — | — | — | \$370 |
| | | PVDMODDMT-1P1U Double Configuration: 1 Power + 1 USB (2 paired units) | — | — | — | — | \$724 |
|  | Flip-up Power & Data Module available in matte black, matte white and aluminium | PVDMODS-2P1U1D Single Configuration: 2 outlets + 1 duplex USB + 1 data port | — | — | — | — | \$502 |
| | | PVDMODD-2P1U1D Double Configuration: 2 outlets + 1 duplex USB + 1 data port (2 paired units) | — | — | — | — | \$977 |

- Wire Management clips are white and attach by double sided tape which is included
- Cable Management Tray (INCMTXX) is available in two lengths, painted Eco Black and includes mounting hardware
- The cable drop has an optional 7' sleeve that is available in black, white, gray and beige

| | | Part number | W | Wt (lbs) | List price |
|---|--------------------------------------|----------------|-----|----------|--------------|
|  | Mesh Cable Management Tray Silver | TWMTRAY | 28" | — | \$133 |

| | | | | | |
|---|-----------------------|----------------|-----|---|-------------|
|  | Cable Management Tray | INCMT18 | 18" | — | \$36 |
| | | INCMT30 | 30" | — | \$47 |

| | | Part number | W | Wt (lbs) | No cable sleeve/ neutral paint/ base price | With cable sleeve | Accent paint |
|---|--|-------------|---|----------|--|----------------------|-----------------|
|  | Cable Drop for use with both standing height and meeting tables with O legs | TWCM | — | — | \$60 | +\$168 | +\$8 |

Finishes

June 2021

inscape

work for tomorrow

INSCAPE SYSTEM FRAMES

Inscape System frames are powder-coated in scuff-resistant Eco-black epoxy. Clips, plates, plugs and bracketry are finished in black.

TRIMS

Trims are available epoxy powder-coated in a smooth or textured finish.

WORKSURFACES

Worksurfaces are available in Nuform Classic, Nuform Select and Laminate.

NUFORM

Nuform is a thermofoil sheet that is continuously bonded to an MDF substrate. The sheet is surface-coated with a scratch resistant film. The underside of the worksurface is finished with low-pressure melamine. Nuform worksurfaces have optional pencil groove. No edge banding is required with Nuform because of its unique design, which wraps the foil to the underside of the worksurface. This eliminates the need for edge banding. Nuform is also available on tiles (ensure the application is reviewed for rules).

NUFORM CLASSIC

| Colorways | Product code |
|----------------|--------------|
| Sandstone | F123 |
| Frosty White | F127 |
| Designer White | F129 |
| Calm Grey | F131 |
| Pitch Black | F132 |
| Honey Brown* | F09 |
| Espresso* | F38 |
| Swiss Elm* | F40 |
| Blonde Maple* | F42 |
| Barn Board* | F43 |

NUFORM SELECT

| Colorways | Product code |
|---------------------|--------------|
| Rustic Plank* | F45 |
| English Walnut* | F46 |
| Natural Plywood* | F47 |
| Nordic Ash* | F48 |
| Ink Thread* | F49 |
| Rose Gold Thread* | F50 |
| Copper Thread* | F51 |
| Fossil Slab | F52 |
| Pearl Slab | F53 |
| Stark Slab | F54 |
| Alabaster Sandstone | F55 |
| Aurora Marble | F56 |
| Pure Oak* | F57 |
| Holland Hickory* | F58 |
| Essential Oak* | F59 |

*Pattern is directional and will have limitation. 48"W standard and split corners are not possible.

LAMINATE

Laminate is bonded to 1.25" thick particleboard. The underside of the worksurface is finished with a wood-fiber veneer backer. Worksurfaces specified with a laminate finish include a 2mm edge banding in a coordinating color. Plastic laminate tops do not have optional pencil groove.

Standard laminate finishes are prefixed with 'LCC' and standard low laminate storage finishes are prefixed with 'MCC'.

Code legend:

- LLC = HPL with matching edge band
- L1C = HPL with matching or plywood edge band
- OCC = HPL with self edge
- O1C = HPL with self edge
- MCC = LPL with matching edge band

| Colorways | Product code | Edge color |
|-----------------|------------------|-----------------|
| Wild Cherry | LCC01 | Rustic Cherry |
| Maple | LCC02 | Fusion Maple |
| White | LCC07 | Designer White |
| Pumice | LCC08 | Beige |
| Antique White | LCC09 | Warm White |
| Gray | LCC12/ MCC009 | Folk Stone |
| Madagascar | LCC14 | Madagascar |
| Asian Sand | LCC15 | Asian Sand |
| River Cherry | LCC16 | River Cherry |
| Wenge | LCC17 | Wenge |
| Elegant White | LCC19 | Frosty White |
| Neowalnut | LCC23 | Neowalnut |
| Mangalore Mango | LCC29 | Mangalore Mango |
| Pearwood | LCC30 | Pearwood |
| Black | LCC33/ MCC012 | Black |
| Walnut Heights | LCC35 | Walnut Heights |
| Studio Teak | LCC36 | Studio Teak |
| Slate Gray | LCC41 | Slate Gray |
| Raven | LCC42 | Raven |
| Dalia | LCC43/ MCC007 | Dalia |
| Mimosa | LCC44/ MCC008 | Mimosa |
| Inspiration | LCC45/ MCC010 | Inspiration |
| Nova White | LCC46/ MCC001 | Designer White |
| Storm | LCC47/ MCC011 | Storm |

| Colorways | Product code | Edge color |
|-------------|------------------|-------------|
| White Lace | LCC48/ MCC013 | White Lace |
| Chill | LCC49/ MCC014 | Chill |
| Haze | LCC51/ MCC016 | Haze |
| Dover White | LCC52 | Dover White |
| Graphite | LCC53 | Graphite |

LCC-18 is available but is reserved for existing customers due to its different edge banding.

GRADE 1 LAMINATE

| Colorways | Product code | Edge color |
|---------------|--------------|---------------|
| Elegant White | L1C001 | Plywood |
| Black | L1C002 | Plywood |
| Slate Gray | L1C003 | Plywood |
| Raven | L1C004 | Plywood |
| White Ash | L1C005 | White Ash |
| Weathered Ash | L1C006 | Weathered Ash |
| Finnish Oak | L1C007 | Finnish Oak |
| Fawn Cypress | L1C008 | Fawn Cypress |

GRADE 2 LAMINATE

| Colorways | Product code | Edge color |
|---------------|--------------|---------------|
| Natural Grain | L2C001 | Natural Grain |

WOOD LEGS

These legs are available on Inscape Bench and the Tables Collection.

| Colorways | Product code |
|-------------|--------------|
| Clear Oak | CLROAK |
| Black Oak | BLKOAK |
| Clear Maple | CLRMPL |

ACRYLIC

| Colorways | Product code |
|-----------|--------------|
| Clear | CA |
| Frosted | FA |
| White | WH |

POLYCARBONATE

| Colorways | Product code |
|-----------|--------------|
| Clear | CP |
| White | WP |

GLASS

| Colorways | Product code |
|----------------|--------------|
| Clear | CL |
| Etched 1 Side | ET1 |
| Etched 2 Sides | ET2 |
| Grey | GRY |

TILES

Inscape System and Bench tiles are available fabric wrapped, epoxy powder coated and in Nuform finishes. Nuform tiles may be specified in finishes same as worksurfaces. Grain direction in Nuform is vertical. Tiles may be covered with our standard fabrics, or covered with COM.

Use of any COM must be approved by Inscape prior to acceptance of order. Refer to “Conditions of Sale, Orders involving Customer’s Own Material (COM)”.

Fabrics with an asterisk* below, as well as any transparent (typically light colored) COM fabrics, will be subject to an upcharge due to additional costs associated with the manufacturing of the tile to eliminate transparency. The upcharge is included in specification tools, or through your Client Services Representative.

SCRIM

Fabric wrapped tiles, including tackable tiles, are available in a variety of standard fabrics as well as COM. COM fabrics are subject to approval. White or extremely light colored COM fabrics will incur an upcharge of 25% to the tile pricing with which the fabric is being applied. This is due to special handling of the fabric and tiles, in addition to painting of the tiles. Light colored fabrics include; but are not limited to:

ANCHORAGE

| Colorways | Product code |
|-----------|--------------|
| White | U1437 |

CAMEO

| Colorways | Product code |
|-----------|--------------|
| Ivory | U2112 |

GAMUT

| Colorways | Product code |
|-----------|--------------|
| Chalk | U3300 |
| Mist | U3338 |
| Pumice | U3339 |
| Pebble | U3340 |

NETIQUETTE

| Colorways | Product code |
|-----------|--------------|
| Bitmap | U1350 |
| Chipset | U1351 |
| Gamma | U1357 |

OFF THE GRID

| Colorways | Product code |
|-----------|--------------|
| Lava | U3110 |
| Steam | U3112 |
| Thermal | U3113 |
| Solar | U3114 |
| Fossil | U3116 |
| Earthglow | U3117 |

PACT

| Colorways | Product code |
|-----------|--------------|
| Calla | U2176 |
| Eureka | U2177 |
| Toasty | U2182 |
| Rubine | U2186 |

SPRITE

| Colorways | Product code |
|-----------|--------------|
| Snow | U5005 |

WHISPER

| Colorways | Product code |
|-------------|--------------|
| Dim | U1485 |
| Ambience | U1486 |
| Silence | U1487 |
| Tranquility | U1488 |
| Peep | U1499 |
| Mellow | U1501 |
| Spirit | U1508 |

Fabric patterns which are available in 54” and 55” width both have limitations on the sizes of tiles available. When being applied “Off the Blot” tile sizes longer than 42” are not available.

Patterns include: Gamut

GRADE 1 FABRICS

ANCHORAGE

| Colorways | Product code |
|---------------|--------------|
| Green Apple | U1400 |
| Red Delicious | U1401 |
| Onyx | U1402 |
| Slate | U1403 |
| Amber | U1404 |
| Willow | U1405 |
| Flax | U1406 |
| Angora | U1407 |
| Green Olive | U1412 |
| Goose | U1413 |
| Cumin | U1414 |
| Deep Water | U1415 |
| Quarry Blue | U1416 |
| Midnight | U1417 |
| Sunshine | U1419 |
| Asteroid | U1421 |
| Coffee Bean | U1425 |
| Geranium | U1426 |
| Thistle | U1427 |
| Chocolate | U1431 |
| Lapis | U1432 |
| Vanilla | U1434 |
| Pumpkin | U1435 |
| Wolf | U1436 |
| White (scrim) | U1437 |

NETIQUETTE

| Colorways | Product code |
|-----------------|--------------|
| Bitmap (scrim) | U1350 |
| Chipset (scrim) | U1351 |
| Dashboard | U1352 |
| Analog | U1353 |
| Schema | U1354 |
| Inkjet | U1355 |
| Vector | U1356 |
| Gamma (scrim) | U1357 |
| Refresh | U1358 |
| Pixel | U1359 |

PEBBLE

| Colorways | Product code |
|------------------|--------------|
| Sindari | U1535 |
| Nice | U1536 |
| Waikiki | U1537 |
| Siesta | U1538 |
| South Beach | U1539 |
| Schoolhouse | U1540 |
| Mabua | U1541 |
| Langkawi | U1542 |
| Tenerife | U1543 |
| Cape Cod | U1544 |
| Maybay | U1545 |
| Surfers Paradise | U1546 |
| Negril | U1547 |
| Papakolea | U1548 |
| Chesil | U1549 |
| Red Beach | U1550 |
| Copacabana | U1551 |

WHISPER

| Colorways | Product code |
|---------------------|--------------|
| Dim (scrim) | U1485 |
| Ambience (scrim) | U1486 |
| Silence (scrim) | U1487 |
| Tranquility (scrim) | U1488 |
| Hush | U1489 |
| Zen | U1490 |
| Stillness | U1491 |
| Mute | U1492 |
| Serenity | U1493 |
| Quiet | U1494 |
| Muffle | U1495 |
| Cloud | U1496 |
| Lull | U1497 |
| Reserve | U1498 |
| Peep (scrim) | U1499 |
| Baffle | U1500 |
| Mellow (scrim) | U1501 |
| Placid | U1502 |
| Chant | U1503 |
| Secret | U1504 |
| Mum | U1505 |
| Undertone | U1506 |
| Mystery | U1507 |
| Spirit (scrim) | U1508 |

GRADE 1 FABRICS (Continued)

MEANDER

| Colorways | Product code |
|-------------|--------------|
| Sandshell | U1061 |
| Overcast | U1062 |
| Agate Taupe | U1063 |
| Nightshadow | U1064 |

UNIVERSE

| Colorways | Product code |
|--------------|--------------|
| Crème Brulee | U1000 |
| Grey Mist | U1001 |
| Wheat | U1002 |
| Seneca | U1003 |
| Milkyway | U1004 |
| Mica | U1005 |
| Cosmic | U1006 |
| Depth | U1007 |

QUATTRO

| Colorways | Product code |
|---------------|--------------|
| Chalk | U1889 |
| Deep Crimson | U1890 |
| Golden Orange | U1891 |
| Granite | U1892 |
| Hibiscus | U1893 |
| Honeycomb | U1894 |
| Khaki | U1895 |
| Laguna | U1896 |
| Leaf | U1897 |
| Mallard | U1898 |
| Mercury | U1899 |
| Midnight Blue | U1900 |
| Pumice | U1901 |
| Skyway | U1902 |
| Spring Green | U1903 |
| Umber | U1904 |
| Wheat | U1905 |

CROSS CHECK

| Colorways | Product code |
|-------------|--------------|
| Biscuit | U1552 |
| Blue Ribbon | U1553 |
| Bottle | U1554 |
| Dove | U1555 |
| Evergreen | U1556 |
| Imperial | U1557 |
| Lime | U1558 |
| Marine | U1559 |
| Otter | U1560 |
| Paradise | U1561 |
| Peacock | U1562 |
| Platinum | U1563 |
| Plumberry | U1564 |
| Red Baron | U1565 |
| Slate Black | U1566 |
| Stone | U1567 |
| Sunshine | U1568 |
| Taupe | U1569 |
| Vermillion | U1570 |

GRADE 2 FABRIC

CAMEO

| Colorways | Product code |
|---------------|--------------|
| Almond | U2110 |
| Metal | U2111 |
| Ivory (scrim) | U2112 |
| Coffee | U2113 |
| Smoke | U2114 |
| Stone | U2115 |
| Mist | U2116 |

PRONTO SOLID

| Colorways | Product code |
|-----------|--------------|
| Drift | U1200 |
| Windblown | U1201 |
| Erosion | U1202 |
| Clear Sky | U1210 |
| Raven | U1215 |
| Darkness | U1220 |
| Breeze | U1280 |

PUNCH CARD

| Colorways | Product code |
|---------------|--------------|
| Alabaster | U2060 |
| Carbon | U2061 |
| Putty | U2062 |
| Silver Lining | U2063 |
| Crisp | U2064 |
| Sky | U2065 |
| Crimson | U2066 |
| Orange | U2067 |
| Navy | U2068 |
| Cadet | U2069 |
| Burgundy | U2070 |
| Peat | U2071 |
| Abyss | U2072 |

CURTAIN CALL

| Colorways | Product code |
|-----------|--------------|
| Latte | U2100 |
| Desert | U2101 |
| Dove | U2102 |
| Pebble | U2103 |
| Tawny | U2104 |
| Sea | U2105 |

PROVERB

| Colorways | Product code |
|-----------|--------------|
| Anchor | U1740 |
| Armor | U1741 |
| Basalt | U1742 |
| Buff | U1743 |
| Cinder | U1744 |
| Crystal | U1745 |
| Linen | U1746 |
| Mist | U1747 |
| Oyster | U1748 |
| Rye | U1749 |
| Steel | U1750 |
| Storm | U1751 |

GRADE 2 FABRIC (Continued)

PACT

| Colorways | Product code |
|----------------|--------------|
| Putty | U2175 |
| Calla (scrim) | U2176 |
| Eureka (scrim) | U2177 |
| Lime | U2178 |
| Coastal | U2179 |
| Nectar | U2180 |
| Dragon | U2181 |
| Toasty (scrim) | U2182 |
| Fern | U2183 |
| Azure | U2184 |
| Delft | U2185 |
| Rubine (scrim) | U2186 |
| Taupe | U2187 |
| Dove | U2188 |
| Aloe | U2189 |
| Harbour | U2190 |
| Tanzanite | U2191 |
| Roma | U2192 |
| Lily | U2193 |
| Sketch | U2194 |
| Patina | U2195 |
| Roast | U2196 |
| Midnight | U2197 |

GLINT

| Colorways | Product code |
|-----------|--------------|
| Barley | U1658 |
| Caspian | U1659 |
| Column | U1660 |
| Gobi | U1661 |
| Gypsum | U1662 |
| Note | U1663 |
| Pearl | U1664 |
| Pumice | U1665 |
| Relic | U1666 |
| Rune | U1667 |
| Serene | U1668 |
| Shale | U1669 |
| Sisal | U1670 |
| Turret | U1671 |
| Vera | U1672 |

SCRIPT

| Colorways | Product code |
|-----------|--------------|
| Almond | U1752 |
| Charcoal | U1753 |
| Feldspar | U1754 |
| Flint | U1755 |
| Nectar | U1756 |
| Patina | U1757 |
| Pebble | U1758 |
| Sand | U1759 |
| Shadow | U1760 |
| Slate | U1761 |
| Sterling | U1762 |
| Taupe | U1763 |
| Zinc | U1764 |

GRADE 3 FABRIC

DASHING

| Colorways | Product code |
|----------------|--------------|
| Antique Sage | U3180 |
| Bespoke Tan | U3181 |
| Dapper Grey | U3182 |
| Gentee Beige | U3183 |
| Polish Slate | U3184 |
| Refine Marble | U3185 |
| Classic Silver | U3186 |

OFF THE GRID

| Colorways | Product code |
|-------------------|--------------|
| Lava (scrim) | U3110 |
| Flora | U3111 |
| Steam (scrim) | U3112 |
| Thermal (scrim) | U3113 |
| Solar (scrim) | U3114 |
| Woodchip | U3115 |
| Fossil (scrim) | U3116 |
| Earthglow (scrim) | U3117 |
| Hydro | U3118 |
| Flame | U3119 |
| Tidal | U3120 |

GAMUT

| Colorways | Product code |
|----------------|--------------|
| Chalk (scrim) | U3300 |
| Nutmeg | U3303 |
| Mango | U3308 |
| Cherry | U3313 |
| Port | U3314 |
| Cerulean | U3317 |
| Pool | U3318 |
| Macaw | U3319 |
| Deep Ocean | U3320 |
| Spruce | U3321 |
| Navy | U3322 |
| Ink | U3323 |
| Olive | U3326 |
| Concord | U3334 |
| Solar | U3335 |
| Persimmon | U3337 |
| Mist (scrim) | U3338 |
| Pumice (scrim) | U3339 |
| Pebble (scrim) | U3340 |

GRADE 3 FABRIC (Continued)

MILLENNIUM

| Colorways | Product code |
|-----------|--------------|
| Aglow | U1628 |
| Amber | U1629 |
| Anchor | U1630 |
| Cascade | U1631 |
| Cavern | U1632 |
| Cerise | U1633 |
| Clean | U1634 |
| Coastal | U1635 |
| Copper | U1636 |
| Crisp | U1637 |
| Electric | U1638 |
| Geode | U1639 |
| Lush | U1640 |
| Mocha | U1641 |
| Monument | U1642 |
| Nector | U1643 |
| Onyx | U1644 |
| Orchid | U1645 |
| Peridot | U1646 |
| Plateau | U1647 |
| Pool | U1648 |
| Pyrite | U1649 |
| Safari | U1650 |
| Sapphire | U1651 |
| Spark | U1652 |
| Steel | U1653 |
| Tanzanite | U1654 |
| Thrill | U1655 |
| Voyage | U1656 |
| Zinc | U1657 |

ODYSSEY

| Colorways | Product code |
|-----------|--------------|
| Alloy | U1765 |
| Amp | U1766 |
| Breeze | U1767 |
| Captain | U1768 |
| Carbon | U1769 |
| Cedar | U1770 |
| Craft | U1771 |
| Cruise | U1772 |
| Dijon | U1773 |
| Eggplant | U1774 |
| Emerald | U1775 |
| Fossil | U1776 |
| Ink | U1777 |
| Inlet | U1778 |
| Iris | U1779 |
| Kiss | U1780 |
| Linen | U1781 |
| Lively | U1782 |
| Maritime | U1783 |
| Nettle | U1784 |
| Oliver | U1785 |
| Opaque | U1786 |
| Primary | U1787 |
| Roast | U1788 |
| Rue | U1789 |
| Sangria | U1790 |
| Skim | U1791 |
| Smith | U1792 |
| Tinge | U1793 |
| Western | U1794 |

GRADE 3 FABRIC (Continued)

TRADITION

| Colorways | Product code |
|-----------|--------------|
| Ash | U1795 |
| Branch | U1796 |
| Class | U1797 |
| Distant | U1798 |
| Flirt | U1799 |
| Fronc | U1800 |
| Grain | U1801 |
| Hedge | U1802 |
| Hidden | U1803 |
| Isle | U1804 |
| Jazz | U1805 |
| Kelly | U1806 |
| Latte | U1807 |
| Malbec | U1808 |
| Miller | U1809 |
| Mist | U1810 |
| Peel | U1811 |
| Plated | U1812 |
| Regal | U1813 |
| Sly | U1814 |
| Soar | U1815 |
| Soy | U1816 |
| Spiced | U1817 |
| Sprout | U1818 |
| Sterling | U1819 |
| Sun | U1820 |
| Tango | U1821 |
| Theater | U1822 |
| Wash | U1823 |
| Weld | U1824 |

BEEHAVE

| Colorways | Product code |
|------------|--------------|
| Azure | U1825 |
| Black | U1826 |
| Carnelian | U1827 |
| Clementine | U1828 |
| Concord | U1829 |
| Currant | U1830 |
| Gris | U1831 |
| Java | U1832 |
| Lapis | U1833 |
| Lemon | U1834 |
| Pear | U1835 |
| Pine | U1836 |
| Plum | U1837 |
| Slate | U1838 |

CADENCE

| Colorways | Product code |
|-----------|--------------|
| Citrine | U1863 |
| Coral | U1864 |
| Garnet | U1865 |
| Jade | U1866 |
| Jet | U1867 |
| Lapis | U1868 |
| Opal | U1869 |
| Pearl | U1870 |
| Peridot | U1871 |
| Quartz | U1872 |
| Ruby | U1873 |
| Sapphire | U1874 |
| Topaz | U1875 |
| Turquoise | U1876 |

GRADE 3 FABRIC (Continued)

OPTIC

| Colorways | Product code |
|-------------|--------------|
| Ash | U1907 |
| Brown Bear | U1908 |
| Coal | U1909 |
| Elephant | U1910 |
| Fieldstone | U1911 |
| Green Apple | U1912 |
| Mulberry | U1913 |
| Mushroom | U1914 |
| Ocean | U1916 |
| Red | U1917 |
| Springtime | U1918 |
| Sunrise | U1919 |
| Tangerine | U1920 |
| Yale | U1921 |

GRADE 4 FABRIC

NO PATTERNS FALL INTO GRADE 4 AT THIS TIME.

PRISM

| Colorways | Product code |
|--------------|--------------|
| Alabaster | U1690 |
| Asparagus | U1691 |
| Café Au Lait | U1692 |
| Caramel | U1693 |
| Caribbean | U1694 |
| Cerulean | U1695 |
| Charcoal | U1696 |
| Claret | U1697 |
| Clay | U1698 |
| Clementine | U1699 |
| Cornflower | U1700 |
| Dove | U1701 |
| Espresso | U1702 |
| Indigo | U1703 |
| Kale | U1704 |
| Lipstick | U1705 |
| Mocha | U1706 |
| Olive | U1707 |
| Onyx | U1708 |
| Plum | U1709 |
| Raisin | U1710 |
| Stone | U1711 |
| Tomato | U1712 |
| Topaz | U1713 |
| Zinc | U1714 |

GRADE 5 FABRIC

SPRITE

| Colorways | Product code |
|--------------|--------------|
| Linen | U5000 |
| Powder | U5001 |
| Khaki | U5002 |
| Kiwi | U5003 |
| Harvest | U5004 |
| Snow (scrim) | U5005 |

GRADE 6 FABRIC

CROSSWEAVE

| Colorways | Product code |
|------------|--------------|
| Flax | UW1101 |
| Antelope | UW1102 |
| Mountain | UW1103 |
| Straw | UW1104 |
| Cantaloupe | UW1105 |
| Tangelo | UW1106 |
| Shiraz | UW1107 |
| Flower | UW1108 |
| Alfalfa | UW1109 |
| Parsley | UW1110 |
| Freshwater | UW1111 |
| Lake | UW1112 |
| Atlantic | UW1113 |
| Soapstone | UW1114 |
| Penguin | UW1115 |
| Seal | UW1116 |

GRADE 7 FABRIC

NO PATTERNS FALL INTO GRADE 7 AT THIS TIME.

- Open House is an upholstery version of our graded Anchorage panel fabric. You can color match with your panel tile selection by choosing the ‘same name’ color from the Open House collection
- COL ‘Customers’ Own Leather - COL is available and will be quoted on a per order basis
- Contrasting Top Stitching - ‘White’ contrasting top stitching is available at ‘no upcharge’. Please specify at time of order placement

GRADE A
OPEN HOUSE

| Pattern | Product code |
|---------------|--------------|
| Green Apple | U1400 |
| Red Delicious | U1401 |
| Onyx | U1402 |
| Slate | U1403 |
| Amber | U1404 |
| Willow | U1405 |
| Straw | U1406 |
| Angora | U1407 |
| Green Olive | U1412 |
| Goose | U1413 |
| Cumin | U1414 |
| Deep Water | U1415 |
| Quarry Blue | U1416 |
| Midnight | U1417 |
| Sunshine | U1419 |
| Asteroid | U1421 |
| Coffee Bean | U1425 |
| Geranium | U1426 |
| Thistle | U1427 |
| Fossil | U1431 |
| Lapis | U1432 |
| Vanilla | U1434 |
| Pumpkin | U1435 |
| Wolf | U1436 |
| Birch | UC2086 |
| Eucalypt | UC2088 |
| Graphite | UC2090 |
| Cobalt | UC2091 |
| Mulberry | UC2092 |
| Pineneedle | UC2095 |
| Aubergine | UC2096 |

PEBBLE

| Pattern | Product code |
|------------------|--------------|
| Sindari | U1535 |
| Nice | U1536 |
| Waikiki | U1537 |
| Siesta | U1538 |
| South Beach | U1539 |
| Schoolhouse | U1540 |
| Mabua | U1541 |
| Langkawi | U1542 |
| Tenerife | U1543 |
| Cape Cod | U1544 |
| Maybay | U1545 |
| Surfers Paradise | U1546 |
| Negril | U1547 |
| Papakolea | U1548 |
| Chesil | U1549 |
| Red Beach | U1550 |
| Copacabana | U1551 |

PUNCH CARD

| Pattern | Product code |
|---------------|--------------|
| Alabaster | U2060 |
| Carbon | U2061 |
| Putty | U2062 |
| Silver Lining | U2063 |
| Crisp | U2064 |
| Sky | U2065 |
| Crimson | U2066 |
| Orange | U2067 |
| Navy | U2068 |
| Cadet | U2069 |
| Burgundy | U2070 |
| Peat | U2071 |
| Abbyss | U2072 |

GRADE A (Continued)

QUATTRO

| Pattern | Product code |
|---------------|--------------|
| Chalk | U1889 |
| Deep Crimson | U1890 |
| Golden Orange | U1891 |
| Granite | U1892 |
| Hibiscus | U1893 |
| Honeycomb | U1894 |
| Khaki | U1895 |
| Laguna | U1896 |
| Leaf | U1897 |
| Mallard | U1898 |
| Mercury | U1899 |
| Midnight Blue | U1900 |
| Pumice | U1901 |
| Skyway | U1902 |
| Spring Green | U1903 |
| Umber | U1904 |
| Wheat | U1905 |

PROVERB

| Pattern | Product code |
|---------|--------------|
| Anchor | U1740 |
| Armor | U1741 |
| Basalt | U1742 |
| Buff | U1743 |
| Cinder | U1744 |
| Crystal | U1745 |
| Linen | U1746 |
| Mist | U1747 |
| Oyster | U1748 |
| Rye | U1749 |
| Steel | U1750 |
| Storm | U1751 |

CROSS CHECK

| Pattern | Product code |
|-------------|--------------|
| Biscuit | U1552 |
| Blue Ribbon | U1553 |
| Bottle | U1554 |
| Dove | U1555 |
| Evergreen | U1556 |
| Imperial | U1557 |
| Lime | U1558 |
| Marine | U1559 |
| Otter | U1560 |
| Paradise | U1561 |
| Peacock | U1562 |
| Platinum | U1563 |
| Plumberry | U1564 |
| Red Baron | U1565 |
| Slate Black | U1566 |
| Stone | U1567 |
| Sunshine | U1568 |
| Taupe | U1569 |
| Vermillion | U1570 |

GRADE A (Continued)

GLINT

| Pattern | Product code |
|---------|--------------|
| Barley | U1658 |
| Caspian | U1659 |
| Column | U1660 |
| Gobi | U1661 |
| Gypsum | U1662 |
| Note | U1663 |
| Pearl | U1664 |
| Pumice | U1665 |
| Relic | U1666 |
| Rune | U1667 |
| Serene | U1668 |
| Shale | U1669 |
| Sisal | U1670 |
| Turret | U1671 |
| Vera | U1672 |

SCRIPT

| Pattern | Product code |
|----------|--------------|
| Almond | U1752 |
| Charcoal | U1753 |
| Feldspar | U1754 |
| Flint | U1755 |
| Nectar | U1756 |
| Patina | U1757 |
| Pebble | U1758 |
| Sand | U1759 |
| Shadow | U1760 |
| Slate | U1761 |
| Sterling | U1762 |
| Taupe | U1763 |
| Zinc | U1764 |

MILLENNIUM

| Pattern | Product code |
|-----------|--------------|
| Aglow | U1628 |
| Amber | U1629 |
| Anchor | U1630 |
| Cascade | U1631 |
| Cavern | U1632 |
| Cerise | U1633 |
| Clean | U1634 |
| Coastal | U1635 |
| Copper | U1636 |
| Crisp | U1637 |
| Electric | U1638 |
| Geode | U1639 |
| Lush | U1640 |
| Mocha | U1641 |
| Monument | U1642 |
| Nector | U1643 |
| Onyx | U1644 |
| Orchid | U1645 |
| Peridot | U1646 |
| Plateau | U1647 |
| Pool | U1648 |
| Pyrite | U1649 |
| Safari | U1650 |
| Sapphire | U1651 |
| Spark | U1652 |
| Steel | U1653 |
| Tanzanite | U1654 |
| Thrill | U1655 |
| Voyage | U1656 |
| Zinc | U1657 |

GRADE A (Continued)

BEEHAVE

| Pattern | Product code |
|------------|--------------|
| Azure | U1825 |
| Black | U1826 |
| Carnelian | U1827 |
| Clementine | U1828 |
| Concord | U1829 |
| Currant | U1830 |
| Gris | U1831 |
| Java | U1832 |
| Lapis | U1833 |
| Lemon | U1834 |
| Pear | U1835 |
| Pine | U1836 |
| Plum | U1837 |
| Slate | U1838 |

ODYSSEY

| Pattern | Product code |
|----------|--------------|
| Alloy | U1765 |
| Amp | U1766 |
| Breeze | U1767 |
| Captain | U1768 |
| Carbon | U1769 |
| Cedar | U1770 |
| Craft | U1771 |
| Cruise | U1772 |
| Dijon | U1773 |
| Eggplant | U1774 |
| Emerald | U1775 |
| Fossil | U1776 |
| Ink | U1777 |
| Inlet | U1778 |
| Iris | U1779 |
| Kiss | U1780 |
| Linen | U1781 |
| Lively | U1782 |
| Maritime | U1783 |
| Nettle | U1784 |
| Oliver | U1785 |
| Opaque | U1786 |

| Pattern | Product code |
|---------|--------------|
| Primary | U1787 |
| Roast | U1788 |
| Rue | U1789 |
| Sangria | U1790 |
| Skim | U1791 |
| Smith | U1792 |
| Tinge | U1793 |
| Western | U1794 |

TRADITION

| Pattern | Product code |
|----------|--------------|
| Ash | U1795 |
| Branch | U1796 |
| Class | U1797 |
| Distant | U1798 |
| Flirt | U1799 |
| Fronde | U1800 |
| Grain | U1801 |
| Hedge | U1802 |
| Hidden | U1803 |
| Isle | U1804 |
| Jazz | U1805 |
| Kelly | U1806 |
| Latte | U1807 |
| Malbec | U1808 |
| Miller | U1809 |
| Mist | U1810 |
| Peel | U1811 |
| Plated | U1812 |
| Regal | U1813 |
| Sly | U1814 |
| Soar | U1815 |
| Soy | U1816 |
| Spiced | U1817 |
| Sprout | U1818 |
| Sterling | U1819 |
| Sun | U1820 |
| Tango | U1821 |
| Theater | U1822 |
| Wash | U1823 |
| Weld | U1824 |

GRADE A (Continued)

CADENCE

| Pattern | Product code |
|-----------|--------------|
| Citrine | U1863 |
| Coral | U1864 |
| Garnet | U1865 |
| Jade | U1866 |
| Jet | U1867 |
| Lapis | U1868 |
| Opal | U1869 |
| Pearl | U1870 |
| Peridot | U1871 |
| Quartz | U1872 |
| Ruby | U1873 |
| Sapphire | U1874 |
| Topaz | U1875 |
| Turquoise | U1876 |

OPTIC

| Pattern | Product code |
|-------------|--------------|
| Ash | U1907 |
| Brown Bear | U1908 |
| Coal | U1909 |
| Elephant | U1910 |
| Fieldstone | U1911 |
| Green Apple | U1912 |
| Mulberry | U1913 |
| Mushroom | U1914 |
| Ocean | U1916 |
| Red | U1917 |
| Springtime | U1918 |
| Sunrise | U1919 |
| Tangerine | U1920 |
| Yale | U1921 |

PRISM

| Pattern | Product code |
|--------------|--------------|
| Alabaster | U1690 |
| Asparagus | U1691 |
| Café Au Lait | U1692 |
| Caramel | U1693 |
| Caribbean | U1694 |
| Cerulean | U1695 |
| Charcoal | U1696 |
| Claret | U1697 |
| Clay | U1698 |
| Clementine | U1699 |
| Cornflower | U1700 |
| Dove | U1701 |
| Espresso | U1702 |
| Indigo | U1703 |
| Kale | U1704 |
| Lipstick | U1705 |
| Mocha | U1706 |
| Olive | U1707 |
| Onyx | U1708 |
| Plum | U1709 |
| Raisin | U1710 |
| Stone | U1711 |
| Tomato | U1712 |
| Topaz | U1713 |
| Zinc | U1714 |

INTUITION

| Pattern | Product code |
|----------|--------------|
| Admiral | U1849 |
| Bisque | U1850 |
| Charcoal | U1851 |
| Coral | U1852 |
| Hickory | U1853 |
| Honey | U1854 |
| Ochre | U1855 |
| Peacock | U1856 |
| Platinum | U1857 |
| Sage | U1858 |
| Sand | U1859 |
| Scarlet | U1860 |
| Slate | U1861 |
| Viridian | U1862 |

GRADE A (Continued)

FEDORA

| Pattern | Product code |
|------------|--------------|
| Aegean | U1583 |
| Aquamarine | U1584 |
| Bitumen | U1585 |
| Cactus | U1586 |
| Charcoal | U1587 |
| Citron | U1588 |
| Dapper | U1589 |
| Dew | U1590 |
| Espresso | U1591 |
| Eucalyptus | U1592 |
| Fawn | U1593 |
| Indigo | U1594 |
| Light Grey | U1595 |
| Midnight | U1596 |
| Mink | U1597 |
| Opal | U1598 |
| Persimmon | U1599 |
| Pewter | U1600 |
| Plumberry | U1601 |
| Purple | U1602 |
| Ruby | U1603 |
| Tangelo | U1604 |
| Tomato | U1605 |
| Topaz | U1606 |
| Winter | U1607 |

RANCHERO

| Pattern | Product code |
|-----------|--------------|
| Basil | U1922 |
| Black | U1923 |
| Brandy | U1924 |
| Chocolate | U1925 |
| Driftwood | U1926 |
| Ecru | U1927 |
| Greige | U1928 |
| Lipstick | U1929 |
| Navy | U1930 |
| Nickel | U1931 |
| Sapphire | U1932 |
| Sepia | U1933 |
| Slate | U1934 |
| Thunder | U1935 |

FLORENTINO

| Pattern | Product code |
|-----------|--------------|
| Bark | U1936 |
| Basil | U1937 |
| Biscuit | U1938 |
| Bluejay | U1939 |
| Caramel | U1940 |
| Chili | U1941 |
| Cream | U1942 |
| Dijon | U1943 |
| Dove | U1944 |
| Fern | U1945 |
| Jet | U1946 |
| Jonquil | U1947 |
| Khaki | U1948 |
| Latte | U1949 |
| Lipstick | U1950 |
| Mango | U1951 |
| Marine | U1952 |
| Mocha | U1953 |
| Mushroom | U1954 |
| Plum | U1955 |
| Sable | U1956 |
| Sapphire | U1957 |
| Scarlet | U1958 |
| Sepia | U1959 |
| Slate | U1960 |
| Turquoise | U1961 |
| Willow | U1962 |

GRADE A (Continued)

KEY LARGO

| Pattern | Product code |
|-------------|--------------|
| Aegean | U1968 |
| Cayenne | U1969 |
| Chocolate | U1970 |
| Crimson | U1971 |
| Ebony | U1972 |
| Gold Coast | U1973 |
| Graphite | U1974 |
| Jonquil | U1975 |
| Jungle | U1976 |
| Khaki | U1977 |
| Nassau | U1978 |
| Palm | U1979 |
| Parchment | U1980 |
| Pear | U1981 |
| Quarry | U1982 |
| Raspberry | U1983 |
| Sand | U1984 |
| Sandstone | U1985 |
| Tangerine | U1986 |
| Toast | U1987 |
| Ultramarine | U1988 |
| Wheat | U1989 |

GRADE B

CROSSWEAVE

| Pattern | Product code |
|------------|--------------|
| Flax | UW1101 |
| Antelope | UW1102 |
| Mountain | UW1103 |
| Straw | UW1104 |
| Cantaloupe | UW1105 |
| Tangelo | UW1106 |
| Shiraz | UW1107 |
| Flower | UW1108 |
| Alfalfa | UW1109 |
| Parsley | UW1110 |
| Freshwater | UW1111 |
| Lake | UW1112 |
| Atlantic | UW1113 |
| Soapstone | UW1114 |
| Penguin | UW1115 |
| Seal | UW1116 |

GRADE B (Continued)

TWEED MULTI

| Pattern | Product code |
|-------------|--------------|
| Taupe | UW1001 |
| Tan | UW1002 |
| Dark Taupe | UW1003 |
| Yellow | UW1004 |
| Pink | UW1005 |
| Flame | UW1006 |
| Medium Blue | UW1007 |
| Turquoise | UW1008 |
| Dark Blue | UW1009 |
| Green | UW1010 |
| Orange | UW1011 |
| Light Grey | UW1012 |
| Medium Grey | UW1013 |

EVOKE

| Pattern | Product code |
|------------|--------------|
| Breeze | U1877 |
| Cerise | U1878 |
| Flax | U1879 |
| Graphite | U1880 |
| Grey Mist | U1881 |
| Iris | U1882 |
| Mahogany | U1883 |
| Natural | U1884 |
| Noir | U1885 |
| Pacific | U1886 |
| Pear | U1887 |
| Terracotta | U1888 |

QUADRILLE

| Pattern | Product code |
|------------|--------------|
| Fair | UC1001 |
| Cabaret | UC1002 |
| Gambol | UC1003 |
| Leisure | UC1004 |
| Regalia | UC1005 |
| Spring | UC1006 |
| Zest | UC1007 |
| Fiesta | UC1008 |
| Carnival | UC1009 |
| Spree | UC1010 |
| Jubilee | UC1011 |
| Opus | UC1012 |
| Masquerade | UC1013 |
| Soiree | UC1014 |
| Revelry | UC1015 |
| Escapade | UC1016 |
| Shenanigan | UC1017 |

GRADE C
NO PATTERNS FALL INTO GRADE C AT THIS TIME.

GRADE D
TINY HERRINGBONE

| Pattern | Product code |
|---------------|--------------|
| Tan | UW4201 |
| Brown | UW4202 |
| Blue Green | UW4203 |
| Blue | UW4204 |
| Medium Grey | UW4205 |
| Dark Charcoal | UW4206 |

COM CALCULATOR

| Cushion Width | Cushion Depth | Cushion Thickness | Fabric Orientation | Back to Back Lateral | Fabric Quantity (run inches) |
|---------------|---------------|-------------------|--------------------|----------------------|------------------------------|
| 15" | 18" | 1.25" | Off the bolt | | 28 |
| 15" | 22" | 1.25" | Off the bolt | | 32 |
| 15" | 28" | 1.25" | Off the bolt | | 38 |
| 15" | 18.75" | 1.25" | Off the bolt | | 29 |
| 15" | 22.75" | 1.25" | Off the bolt | | 33 |
| 15" | 28.75" | 1.25" | Off the bolt | | 39 |
| 15" | 36" | 1.25" | Off the bolt | • (Planna Peds) | 47 |
| 30" | 18" | 1.25" | Off the bolt | | 28 |
| 30" | 36" | 1.25" | Off the bolt | • | 47 |
| 36" | 18" | 1.25" | Off the bolt | | 29 |
| 36" | 36" | 1.25" | Off the bolt | • | 47 |
| 42" | 18" | 1.25" | Off the bolt | | 29 |
| 42" | 36" | 1.25" | Off the bolt | • | 47 |
| 60" | 18" | 1.25" | Off the bolt | | N/A |
| 66" | 18" | 1.25" | Off the bolt | | N/A |
| 72" | 18" | 1.25" | Off the bolt | | N/A |
| 78" | 18" | 1.25" | Off the bolt | | N/A |
| 84" | 18" | 1.25" | Off the bolt | | N/A |
| 15" | 18" | 1.25" | Railroad | | 25 |
| 15" | 22" | 1.25" | Railroad | | 25 |
| 15" | 28" | 1.25" | Railroad | | 25 |
| 15" | 18.75" | 1.25" | Railroad | | 25 |
| 15" | 22.75" | 1.25" | Railroad | | 25 |
| 15" | 28.75" | 1.25" | Railroad | | 25 |
| 15" | 36" | 1.25" | Railroad | | 25 |
| 30" | 18" | 1.25" | Railroad | | 41 |
| 30" | 36" | 1.25" | Railroad | • | 41 |
| 36" | 18" | 1.25" | Railroad | | 47 |
| 36" | 36" | 1.25" | Railroad | • | 47 |
| 42" | 18" | 1.25" | Railroad | | 52 |
| 42" | 36" | 1.25" | Railroad | • | 52 |
| 60" | 18" | 1.25" | Railroad | | 69 |
| 66" | 18" | 1.25" | Railroad | | 75 |
| 72" | 18" | 1.25" | Railroad | | 83 |
| 78" | 18" | 1.25" | Railroad | | 87 |
| 84" | 18" | 1.25" | Railroad | | 93 |

HOW TO CALCULATE COM YARDAGE REFER TO 'COM FABRIC CALCULATOR'

INPUT

1. Select cushion width and depth appropriate to your specification
2. Select cushion thickness
3. Select fabric orientation (refer to 'Cushion Layup' sketches)
4. Find the corresponding fabric quantity in 'running inches' from the table

CALCULATION

1. Multiply the number of cushions required by the fabric quantity in 'running inches' off of the table
2. Divide the number of running inches by 36 to convert to yardage required. Round up to the nearest half yard.
3. If a pattern repeat is required, ordering a sample cushion is advised to determine fabric yardage and any applicable upcharges. A layup instruction will also be required for review.

EXAMPLE:

- Storage with Handles Pedestal

- Quantity – 31 cushions

- 15"wide x 22"deep x 1.25" thick

- COM fabric is a solid colour and has no directional weave; best fabric usage is 'off the bolt' orientation.

Note: Highlighted areas on the COM Calculator indicates 2 cushion yield per piece.

CALCULATION:

32 running inches x 16 cushions = 512" of fabric required

512" divided by 36 = 14yds, 8"

Total fabric required = 14 ½ yards (rounded up)

ADDITIONAL SPECIFICATION INFORMATION:

1. Pedestal Cushion Depth options vary by product profile and application. Ensure you are referencing the correct dimensions
2. Lateral Cushion Depth options vary by application Ensure you are referencing the correct dimensions
3. Fabric Quantity is based on a 54" wide roll
4. Highlighted rows yield 2 cushions per fabric quantity listed
5. All directional/patterned fabrics (Graded or COM) require cushion layup instructions with order placement. Depending on layup additional fabric may be required and upcharges may apply. If layup instructions are not provided the layup that maximizes the production yield will be chosen. (Refer to the layup diagrams)
6. For any cushion sizes not listed on the COM Calculator or for further information please contact your Client Service Representative for assistance

FABRIC LAYUP

LATERAL CUSHION FABRIC LAYUP

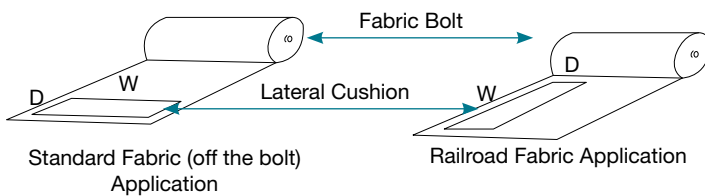

PEDESTAL CUSHION FABRIC LAYUP

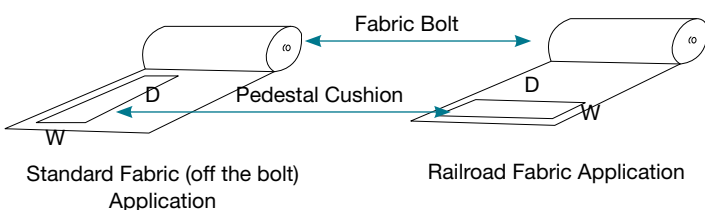

For COM fabric testing on Adjustable Framed Table Mounted Screens (MST37XX) and tiles, please provide the following to your SRT – Customer Experience specialist:

- (1) memo sample of the fabric to be tested
- (1) yard of fabric to be tested
- Product Code that the fabric is to be applied to

Testing turnaround times are 3 to 5 days upon receipt of memos samples/yardage. Your Customer Experience specialist will provide the results of the application testing.

For COM fabric testing on all other products including cushions, divider screens and risers, please provide the following to your SRT – Customer Experience specialist:

- (4) memo samples of the fabric to be tested
- Product Code that the fabric is to be applied to

General testing turnaround times are 48 to 72 hours upon receipt of memos samples. Your Customer Experience specialist will provide the results of the application testing.

PAINT CODE MATRIX

Painted System and Bench components include; tiles, trim, support brackets, accessories, legs and storage.

The following prefixes will be referenced on order acknowledgements:

| | |
|-----------|---|
| E | indicates standard paint on all filing and storage items |
| ET | indicates standard textured paint on all filing and storage items, a 10% upcharge is applicable to the net value of the product |
| EA | indicates standard accent paint on all filing and storage items |
| P | indicates standard paint on all other items |
| PT | indicates standard textured paint on all other items, a 10% upcharge is applicable to the net value of the product |
| PA | indicates standard accent paint on all other items |

CUSTOM (NON-STANDARD) COLORS

Inscape offers colors matched to a customer's specification when possible. This matching is done through a database of over 3,000 existing color formulas or the development of a new custom color. A \$324 net fee applies for each custom color per order. In addition, Custom Premium colors (bright whites and bright colors; textured paints; and reflection paints that use mica, aluminum or special chemical to create their reflective properties) will be subject to a 10% upcharge to the net value of the product per order.

MULTI-COLOR CABINETS

For multi-color cabinets where the case is one color and the drawer fronts are a second color, a \$270 net fee applies per color per order. (Tie bars and reference shelves will be painted the same color as the case.). This charge is applicable for multi-colour applications using Neutral, Accent or Custom paints. If using an Accent paint on a Multi-color cabinet, the standard Accent paint upcharge for the unit will also be applicable.

NOTE: Multi-color cabinets are not available on Storage with Handles.

TEXTURED COLORS

- Available
- Unavailable

NOTE: A 10% UPCHARGE IS APPLICABLE TO THE NET VALUE OF THE PRODUCT FOR TEXTURED COLORS.

NEUTRAL PAINT COLLECTION

| Name | Color code | Textured colors |
|-------------------------|------------|-----------------|
| Bisque | 004 | ● |
| Chinook | 010 | ○ |
| Onyx | 013 | ● |
| Frost | 022 | ● |
| Arctic | 023 | ● |
| Champagne | 024 | ● |
| Titanium | 052 | ● |
| Mushroom | 055 | ○ |
| Krypton Reflections | 063 | ● |
| Cinder Reflections | 066 | ● |
| Soapstone | 112 | ● |
| Warm White | 121 | ● |
| Mist | 122 | ○ |
| Sandstone | 123 | ● |
| Light Taupe | 124 | ● |
| Medium Gray | 126 | ● |
| Nickel Reflections | 127 | ● |
| Slate Reflections | 128 | ● |
| Quartz | 160 | ○ |
| Glacier White | 168 | ○ |
| Charcoal Gray | 205 | ● |
| Pebble Gray | 217 | ● |
| Deep White | 223 | ● |
| Mocha | 255 | ○ |
| Latte | 274 | ○ |
| Juniper Reflections | 281 | ○ |
| Quicksilver Reflections | 282 | ○ |
| Sunstone Reflections | 284 | ● |
| Aluminum Leaf | 290 | ● |
| Sasha | 300 | ○ |
| Elson | 301 | ○ |
| Shade | 302 | ○ |
| Anonymous | 303 | ○ |
| Urban | 304 | ○ |
| Dorian | 305 | ○ |
| Dover | 306 | ○ |
| Jubilee | 307 | ○ |
| Softer Tan | 308 | ○ |
| Storm Cloud | 309 | ○ |
| Rice Grain | 310 | ○ |
| Ramie | 311 | ○ |

NEUTRAL PAINT COLLECTION (Continued)

| Name | Color code | Textured colors |
|----------------------|------------|-----------------|
| Favorite Tan | 312 | |
| High Tea | 314 | |
| Stone Reflections | 315 | |
| Dovetail Reflections | 316 | |
| Yorkshire | 317 | |
| Coriander | 318 | |
| Snowcap | 319 | |
| Salem | 320 | |
| Burnt Sierra | 321 | |
| Drizzle | 322 | |
| Scroll | 323 | |
| Cumin | 324 | |
| Seagull | 325 | |
| Smoke | 326 | |
| Gunpowder Blue | 327 | |
| Starlight Silver | 329 | |
| Martini Reflections | 330 | |
| Laminate White | 332 | |
| Steel Wool | 334 | |
| Kettle Black | 335 | |
| White Velvet | 336 | |
| Simply White | 337 | |
| Dark Bronze ** | 338 | |

****Due to the semi-transparent nature of clear coat paint finish, the substrate material, as well as markings from the manufacturing process may be visible through the finish. For warranty information, please refer to the Inscape North American warranty on [inscapesolutions.com](https://www.inscapesolutions.com)**

ACCENT PAINT COLLECTION

Standard colors are prefixed with a 'A'.

| Name | Color code |
|--------------|------------|
| Peony | A339 |
| Lilac | A340 |
| Amethyst | A341 |
| Mulberry | A342 |
| Plum | A343 |
| Citrine | A344 |
| Canary | A345 |
| Lotus | A346 |
| Monarch | A347 |
| Coral | A348 |
| Amaryllis | A349 |
| Apricot | A350 |
| Cantaloupe | A351 |
| Poppy | A352 |
| Caliche | A353 |
| Obsidian | A354 |
| Dahlia | A355 |
| Honeydew | A356 |
| Sage | A357 |
| Hummingbird | A358 |
| Spring | A359 |
| Marimo | A360 |
| Fern | A361 |
| Azure | A362 |
| Wave | A363 |
| Lapis Blue | A364 |
| Atoll | A365 |
| Papillon | A366 |
| Lagoon | A367 |
| Night Sky | A368 |
| Aqua | A369 |
| Inscape Teal | A370 |

Care & Maintenance

June 2021

inscape

work for tomorrow

Care & Maintenance

The following information provides general guidelines for cleaning and maintaining Inscape products including: Worksurfaces, Tables, Supports, Tiles, Trim, Screens, Storage and Accessories.

NUFORM

Nuform surfaces are manufactured by thermoforming a polymer sheet around an MDF substrate. The polymer sheet is surface-coated with a scratch resistant film.

- For general cleaning, use warm soapy water, a mild, non-abrasive household cleanser or a 10-20% Bleach solution
- To remove stains like permanent marker use a cotton ball dampened with Acetone
- On tougher stains, use a cotton ball dampened with methyl hydrate
- Do not use abrasive cleansers or highly solvent based chemicals such as gasoline, acetone or toluene as they may scratch or affect the surface appearance
- Do not place hot appliances directly on Nuform surfaces
- Although Nuform is scratch resistant, avoid dragging sharp objects across the surface
- Light scratches may be buffed from the foil surface by using a 400-600 grit wet sandpaper under light hand pressure in circular motions or by using a 3M Scotch Brite Pad (green color only) under light hand pressure in circular motions. Note: Under no circumstances should power buffing tools be used
- Chips and deep scratches may be repaired by a professional touch-up service. Minor imperfections should be addressed immediately as neglect can result in more serious problems that could void the warranty
- Optimal storage temperature range for Nuform surfaces is 41°F to 86°F
- Avoid exposure to extreme heat, cold and humidity

LAMINATE

High pressure laminate is available for use on surfaces, selected accessories and is optional on laminate storage door fronts. Low pressure laminate is available for use on laminate storage cases and door fronts. Both laminate options are laminated to particleboard and includes a color coordinated edge banding.

- Dust off laminated surfaces prior to cleaning
- For general cleaning, use a damp cloth with warm soapy water or a mild, non-abrasive household cleanser. Do not use a cleanser with acids or alkalis as this will damage the surface. Remember to wipe the surface with the grain using a dry soft cloth.
- An eraser may assist with removing ink marks
- Isopropyl Alcohol or Rubbing Alcohol may be used to clean laminate surfaces
- Do not use abrasive cleaners or bleaching cleansers as they may scratch or affect the surface appearance
- Take note that any product with Hydrochloric, Sulfuric, or Phosphoric acid may permanently damage the surface
- Although high pressure plastic laminates are resistant to scratching and wear, avoid dragging sharp objects across the surface
- Do not place hot appliances directly onto laminate surfaces
- Avoid exposure to extreme heat, cold or humidity

Care & Maintenance

WOOD

Wood is an option on legs and supports. Like all natural products, wood legs may vary slightly in grain, texture and color. For this reason, minor variations between pieces can be expected.

- Dust surface with a dry cloth in the direction of the grain
- For dirtier surfaces, use warm soapy water and a soft cloth
- Do not use abrasive cleaning products as they may scratch or affect the surface appearance
- Although waxing and polishing is not necessary, waxing and polishing products may be applied if care is taken to avoid wax build-up which may cloud the finish
- Exposure to strong sunlight should be avoided since fading may result
- Avoid exposure to extreme heat, cold or humidity
- Avoid dragging sharp objects across the surface
- Chips and scratches may be repaired by a professional touch-up service

FABRIC

- Vacuum or lightly brush panel fabrics to remove dirt build-up
- Promptly remove stains by blotting, not rubbing the fabric to retain pile texture
- Fabric may be cleaned with mild water-free solvents or water-based cleaning agents or foam
- Always follow the manufacturer's instructions and test clean a non-visible area first

PAINTED METAL

- Clean with a soft damp cloth and warm soapy water
- Gently rub tougher grime away with a mild, non-abrasive household cleaning product
- Paint touch up kits are available for minor repairs
- **Note:** Most consumer cleaners may be used, always spot test products to ensure no hazing or softening of the coated film takes place

GLASS

- Clean glass with a mild window cleaner

ACRYLIC

- Clean acrylic with a clean soft cloth and warm soapy water

WHITEBOARDS/DRY ERASE BOARDS

- Use only dry erase markers on boards
- Clean boards with an eraser or microfiber cloth and cleaner that is formulated for whiteboards
- Inscape recommends using "Sanford Expo Dry Erase Markers" and "Sanford Whiteboard Cleaner"

BIN/SHELF-MOUNTED TASK LIGHT FIXTURES

- Include a 120V/60HZ magnetic ballast. Replacement ballasts can be purchased from any electrical supply store

Transit Times

June 2021

inscape

work for tomorrow

Care & Maintenance

UNITED STATES:

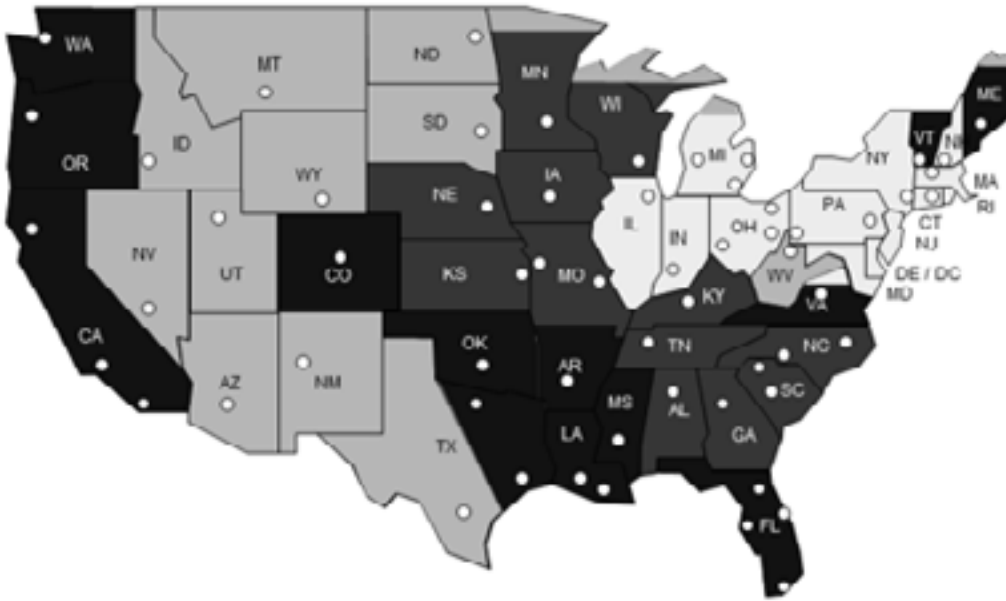

FROM DATE OF DEPARTURE:

3-5 Day Transit

NH, MA, CT, NY, RI, PA, MD, DE, DC, OH, IN, IL, MI, NJ

4-6 Day Transit

SC, GA, AL, TN, NC, MO, KS, IA, NE, MN, WI, KY

5-7 Day Transit

CO, CA, FL, OR, WA, TX, VA, VT, ME, MS, LA, AR, OK

5-8 Day Transit

WV, MT, ND, SD, ID, WY, UT, NV, AZ, NM, TX

*Date of departure may be any day in the acknowledged ship week ending.

inscape

67 Toll Road
Holland Landing, Ontario
L9N 1H2 Canada

T 905 836 7676

F 905 836 6000

Toll Free 1 866 467 2273

myinscape.com

© Inscape Corporation 2021™

® Trademarks of Inscape Corporation. Patents may be pending. Certain names, words, logos and graphics or designs contained herein are trademarks or service marks of Inscape Corporation.