

System | Bench | Tables

# State of Alabama Price List

June 2021



**inscape**

work for tomorrow

## Conditions of Sale

Refer to the Conditions of Sale document on the [Support](#) page of [myinscape.com](#).

## System

Architecture	10		
<hr/>			
<b>Frames and Screens</b>	<b>11</b>		
General Information	11		
3 ½" Thick	13		
– Standard Frames	13		
– Basic Frames	15		
– Stack-on Frames	17		
– Double Glazed Stack-on Frames	18		
2 ¾" Thick	19		
– Standard Frames	19		
– Basic Frames	21		
– Stack-on Frames	23		
– Double Glazed Stack-on Frames	24		
1 ½" Thick	25		
– Segmented Screens	25		
– Glazed Segmented Screens	26		
– Monolithic Screens	27		
– Accessory Screens	29		
– Freestanding Screens	30		
– Table Mounted Screens	31		
Sliding Doors	32		
<b>Connectors and Trim</b>	<b>33</b>		
General Information	33		
3 ½" Thick	35		
– Trim	35		
– 90° Connector Kits	36		
– 90° Same Height Connector Kits	37		
– 90° Stack-on Connector Kits	38		
– 120° Connector Kits	39		
2 ¾" Thick Trim	40		
– 90° Connector Kits	41		
– 90° Same Height Connector Kits	42		
– 90° Stack-on Connector Kits	43		
– 120° Connector Kits	44		
– Screen Connectors	45		
		1 ½" Screen to 3 ½" Frame Connector Kits	46
		1 ½" Screen to 3 ½" Frame Connector Kits	47
		2 ¾" Frame to 3 ½" Frame Same	
		Height Connector Kits	48
		Planna Storage Benching End Trim	49
		<b>Tiles</b>	<b>50</b>
		General Information	50
		Painted	53
		Fabric	55
		Tackable	57
		Nuform	58
		Nuform Patterned	59
		Whiteboard	60
		Paper Management	61
		Paper Management Tile Reinforcing Kit	62
		Perforated	63
		Communication - Painted	64
		Communication - Fabric	65
		Multi Access - Painted	67
		Multi Access - Fabric	68
		Double Glazed	69
		Monolithic - Painted	70
		Monolithic - Fabric	71
		Planna Storage Benching Multi Access	72
		Foam Bumper	73

## System

---

### Technology 74

---

General Information	75	<b>Jumper Cables</b>	<b>86</b>
<b>Power In Feeds</b>	<b>80</b>	<b>Receptacles</b>	<b>87</b>
Floor/Wall	80	USB Power Modules	88
Ceiling Power Pole Kits	81	<b>Task Lights</b>	<b>89</b>
Chimney Power Feed Frame	82	<b>Data Components</b>	<b>90</b>
<b>Frame Components</b>	<b>83</b>	<b>Clamp On Power &amp; Data Modules</b>	<b>91</b>
Chicago Electrical Components	83	<b>Clamp On Power &amp; Data Modules</b>	<b>92</b>
Beltline Cover Kits	84		
<b>Power Tracks</b>	<b>85</b>		

---

### Worksurfaces & Supports 93

---

<b>Panel Mounted Worksurfaces</b>	<b>94</b>	<b>Transaction tops</b>	<b>110</b>
General Information	94	General Information	110
Rectangular Tops	96	For 3 1/2" Thick Frames	111
90° Rectangular Tops	98	For 2 3/4" Thick Frames	112
True Sized Rectangular Tops	99	<b>Supports</b>	<b>113</b>
Reducing Tops	100	General Information	113
Saddle Tops	101	Panel Mounted Worksurface Supports	115
90° Saddle Tops	102	Worksurface Supports	119
Galley Tops	103	Planna Worksurface Support Brackets	120
Standard Corners	104	Legs and Leg Docking Brackets	121
Extended Corners	105	1 1/2" Screen Worksurfaces Docking Brackets	123
120° Corners	108		
Conference Tops	109		

## System

Storage	124		
<b>Lock locations</b>	<b>125</b>	Storage Bin Brackets	160
<b>Pedestals</b>	<b>127</b>	Up-Mount Bin Supports and Brackets	161
General Information	127	Shelves + Brackets	162
Storage with Handles	130	Up-Mount Bin Accessories	163
9900 Series Front	132	Twin-Bins	165
Nuform Front	135	Twin-Bin Brackets	166
Pedestal Brackets	136	Twin-Bin Accessories	167
<b>Laterals</b>	<b>138</b>	<b>Pianna Storage</b>	<b>168</b>
General Information	138	General Information	168
Storage with Handles	141	Base Modules	170
9900 Series Front	142	Sliding Doors	175
Nuform Front	144	Benching End Trim	176
Lateral Brackets	145	<b>Laminate Storage</b>	<b>177</b>
<b>Towers</b>	<b>147</b>	General Information	177
General Information	147	Pedestals	179
9900 Series Front	149	Laterals	180
Nuform Front	152	Open Bookcases	181
<b>Overhead Storage</b>	<b>155</b>	Combination Bookcase/Laterals	182
General Information	155	Hinged Door Cabinets	183
Storage Bins	158	Overhead Bins + Shelves	184
Hinged Door and Up-Mount Bins	159	Manhattan Tower	185
		Accessories	186
Accessories	190		
General Information	191	<b>Electrified Twin-Bin</b>	<b>212</b>
<b>Horizontal</b>	<b>195</b>	<b>Twin Bin</b>	<b>213</b>
<b>Panel and Table</b>	<b>196</b>	<b>Pedestal</b>	<b>214</b>
<b>Modesty Panel</b>	<b>199</b>	<b>Lateral</b>	<b>215</b>
<b>Privacy Screens</b>	<b>202</b>	<b>Back Painted Glass</b>	<b>218</b>
<b>Add-on Glazing</b>	<b>204</b>	<b>SuperStor™</b>	<b>219</b>
3 ½" T	204	<b>Cushions</b>	<b>220</b>
2 ¾" T	206	<b>Pianna Storage</b>	<b>222</b>
<b>Wall Mounted</b>	<b>208</b>	Brackets and Rails	222
<b>Storage</b>	<b>210</b>	Pedestals and Lateral Tops	223
<b>Overhead Storage</b>	<b>211</b>	Tops to Accommodate Benching Electrical	225

## Bench

Architecture	227		
General Information	228	<b>Connectors and Trim</b>	<b>238</b>
<b>Spines</b>	<b>231</b>	<b>Tiles</b>	<b>241</b>
Spine Frames	231	Full Height Spine Tiles	241
Stack-on Frames	232	Partial Height Spine Tiles	242
Spine Support Legs	234	10.125" H Stack-On Tiles	246
Technology	248		
General Information	249	<b>Data Components</b>	<b>255</b>
<b>Power In Feeds</b>	<b>252</b>	<b>Power and Data Accessories</b>	<b>256</b>
<b>Electrical Components</b>	<b>253</b>	<b>Clamp On Power &amp; Data Modules</b>	<b>257</b>
Worksurfaces & Supports	258		
General Information	259	<b>Worksurfaces Supports</b>	<b>274</b>
<b>Rectangular Tops</b>	<b>262</b>	90° Application	276
Middle Application	262	Parallel Application	278
Full End Gable Application	263	Full Gable	280
Open End Leg Application	264	Full Gable Brackets	283
End Storage Application	265	Open A Leg	284
<b>90° worksurface</b>	<b>266</b>	Open H Leg	286
<b>120° Worksurface</b>	<b>267</b>	Open O Leg	288
Middle Application	267	For Electric Height Adjustable	
Full End Gable Application	268	Application Only	289
Open End Leg Application	270		
<b>Height Adjustable Worksurface</b>	<b>272</b>		
Electric	272		

## Bench

Storage	290		
General Information	291	9900 Series Front	297
9900 Series Front	295	<b>Bookcases</b>	<b>298</b>
<b>Laterals</b>	<b>296</b>	<b>Twin-Bins and Brackets</b>	<b>299</b>
Storage with Handles	296		
Accessories	301		
General Information	302	<b>Hang-On Accessories</b>	<b>317</b>
<b>Spine Accessories</b>	<b>304</b>	<b>Worksurface Screens for 90° Workstations</b>	<b>318</b>
Transaction Tops	305	<b>Worksurface Undermount</b>	<b>320</b>
Up-Mount Bins	306	<b>Replacement Fabric Skins</b>	<b>321</b>
Upmont Shelves	308		
Add-on Glazing	309		
Spine Dividers	311		
<b>Open leg Accessories</b>	<b>313</b>		
<b>Worksurface Dividers</b>	<b>315</b>		

## Tables

---

Tables Collection	324		
-------------------	-----	--	--

---

<b>Standing Height Tables</b>	<b>325</b>	<b>Coffee Tables</b>	<b>330</b>
<b>Meeting Tables</b>	<b>327</b>		

---

Worksurfaces	331		
--------------	-----	--	--

---

<b>Square and Rectangular Tops</b>	<b>332</b>	<b>Trapezoid Tops</b>	<b>337</b>
<b>Racetrack and Boat Tops</b>	<b>333</b>	<b>Hex, Pebble and Rhombus Tops</b>	<b>338</b>
<b>Round Tops</b>	<b>334</b>	<b>Rectangular Tops with Power Module</b>	<b>339</b>
<b>Semi-circle Tops</b>	<b>335</b>	<b>Bullet, Bean, Oval and Curved</b>	
<b>Quarter-circle Tops</b>	<b>336</b>	<b>Rectangular Tops</b>	<b>340</b>

---

Legs & Bases	341		
--------------	-----	--	--

---

<b>Legs</b>	<b>342</b>	<b>Bases</b>	<b>345</b>
-------------	------------	--------------	------------

---

Accessories	346		
-------------	-----	--	--

---

<b>Surface Support Accessories</b>	<b>347</b>	<b>Modesty Panels</b>	<b>349</b>
<b>Table Mounted Screens</b>	<b>348</b>	<b>Electrical Accessories</b>	<b>353</b>

**Finishes** 356

**Care & Maintenance** 383

**Transit Times** 386



# **System** US Price List

June 2021

**inscape**

work for tomorrow

# System Architecture

**inscape**

work for tomorrow

Inscape System frames are constructed of 16 gauge tubular steel uprights with welded 18 gauge steel crossrails. This strong yet lightweight construction provides ease of movement and reconfiguration.

The simplicity of the frame structure provides an intelligent solution to cable management. The absence of baseplates, apertures and corner posts eliminate barriers that restrict the routing of cables. Cabling may be routed both vertically and horizontally through the panel. Cables are laid into cable managers that easily install between panel crossrails throughout the framework. Cable managers safely cradle and segregate cables. An aperture free system means installation and reconfiguration costs are kept to a minimum. Cabling may also enter the system through the top or face of the panel. Reconfiguration is easy and economical. Cabling simply eases out of the cable managers and is laid back in at the desired point, eliminating the costly need to cut and re-terminate cables for every reconfiguration. Panels do not have creep.

### 3 1/2" THICK FRAME

The 3 1/2" Thick Frame accommodates approximately 96 Cat6 or 125 Cat5 cables per 13.5" H zone at a fill capacity of 60% between the upright and the tile. Frames and frame specific components for the 3.5" thick frame are denoted by the suffix "-3F".

### 2 3/4" THICK FRAME

The 2 3/4" Thick Frame accommodates approximately 52 Cat6 or 67 Cat5 cables per 13.5" H zone at a fill capacity of 60% between the upright and the tile. Frames and frame specific components for the 2.75" thick frame are denoted by the suffix "-2F".

### STANDARD FRAMES

A Standard Frame has a beltline cover kit enabling power to run at the beltline location without the need of a "cutout" tile. Standard frames are available for both the 3.5" and 2.75" thick frames. Frames 37" H and higher come equipped with one wire manager. Electrical and data components must be specified separately. Standard heights that are available include 37", 44", 51", 57" and 64".

**NOTE: Tiles cannot be placed over the cover kit on a 2 3/4" thick frame. The Cover Kit frame clip cannot accommodate a tile hanging from the clip.**  
**NOTE: 27" H tiles cannot be mounted in bottom position on a 2 3/4" thick standard frame.**

### BASIC FRAMES

Basic Frames do not include the electrical cover kit but may house power which is to be accessed at all locations with a "cutout" tile. Basic frames 37" H and higher come with one wire manager. Basic frames are available for both the 3.5" and 2.75" thick frames. Basic heights available include 24", 29", 37", 44", 51", 57" and 64". The 3 1/2" thick frame by 24" H includes the mounting hardware to attach to a Credenza Storage case when used in a benching application.

Both types of frames feature glides that provide 1 1/2" height adjustment allowing air to circulate under panels and throughout the office. Frames are available in 6" increments in widths ranging from 18" W to 60" W.

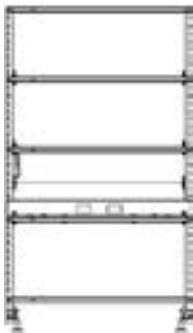

Standard Frames



Basic Frames

### STACK ON FRAME

The Stack on Frame consists of a 6.75", 13.5", 20.25" and 27" frame which may be installed on a Standard or Basic frame of the same width or combination of two frames as outlined in the Inscape System Application Guide only. The Stack on frame is load bearing to one storage unit above 64" H and may be stacked up to 91" H. Tiles and trim are specified separately. The top cap from the base frame may be used on the stack on frame. Stack on frames are frame thickness specific and should be specified accordingly.

### DOUBLE GLAZED STACK-ON KIT

Double Glazed Stack-On Kit is a stack on frame with a double glazed insert. The 24" to 60" W Double Glazed Stack is a fully welded frame stack on. Double Glazed Stacks which are 54" and wider are kitted and are installed on site. The Double Glazed Stack on is not load bearing and no stacks can be stacked on top of the Double Glaze. Stack on frames are frame thickness specific and should be specified accordingly. Finishes are available in Clear or Frosted Acrylic to match Double Glazed tile.

		Dimensions			
		A	B	C	D
SYSTEM	TRIM	TOP CAP TO TOP TILE	TOP TILE TO BOTTOM TILE	BOTTOM TILE TO FLOOR*	FLOOR TO CANTILEVER
INSCAPE SYSTEM	Tapered	1.1	24" h = 20.050	1.843	27.24
			29" h = 26.800		
	Flat	0.65	37" h = 33.550		
			44" h = 40.300		
			51" h = 47.050		
			57" h = 53.800		
			64" h = 60.550		



Note: Dimensions 'C' & 'D' measured with frames at lowest glide position. Frame can be raised up to 1.500" depending on configuration and leveling.

## 1 1/2" THICK SCREEN

The 1.5" Thick Screen is available in a freestanding version or one that is intended to be joined to adjacent screens. The screen is inclusive of a finished frame, 1/2" tackable core (fabric option) and glides. Various configurations of the segmented or monolithic screen are available including all fabric, fabric with acrylic or resin and polycarbonate. Whiteboard accessories should follow the same guidelines as the Whiteboard tile. No assembly is required with the screen.

## TABLE MOUNTED SCREEN

The Table Mounted Screen is constructed of a 1.5" thick extruded aluminum frame and is designed to provide modesty and privacy to adjacent work areas. This 37" H screen mounts onto a 1" or 1.25" thick worksurface and may be adjusted vertically to create the desired privacy or modesty. The tackable 1/2" thick core may be specified in any of Inscape's standard fabrics or COM. Height adjustable brackets allow for various screen height positions. It is recommended that the table mounted screen be installed 20" above the surface with 16" below. Table mounted screens cannot be attached to 1.5" thick screen brackets attaching to thicker frames.

## 1 1/2" ELECTRIFIED STORAGE FRAME

The 1.5" Electrified Storage Frame is an open structure frame which is positioned between Electrified Storage units to allow technology to run through when a 1 1/2" connection is required and a 1 1/2" screen is to run perpendicular to Electrified Storage spine.



## INSCAPE SYSTEM SLIDING DOOR

Inscape System Sliding Door is a 1 1/2" thick extruded aluminum frame which is available to match 51" and 64" panel heights and openings of 36" and 42". The sliding door includes a door assembly consisting of door trim, polycarbonate panel, two door pulls, two 2.5" adjustable wheels and top/bottom connector brackets to attach to the panel frame. A locking version is available and is secured in the closed position by a lock at the opposite side of the handle. Polycarbonate has naturally occurring variations in the material. The tile configuration must be such that the crossrail at 37" H is accessible where the lock mechanism is located. See Inscape System Application Guide.

The 36" W sliding door is installed on any panel or combination of panels 42" in width.

The 42" W sliding door is installed on any panel or combination of panels 48" in width.

Sliding Doors are handed and need to be specified left or right for the direction in which the door is required to slide once installed on the front of the workstation.

## GENERAL INFORMATION

To facilitate specification of connector kits for various multi-height panel configurations, preconfigured connector kits have been created. Connector kits include all the vertical trims, connectors, plugs and plates required to make and complete the connection at the junction point.

The panel configurations shown on the following pages have been grouped according to the type of connection: 'L' Connection (two-way 90°), 'T' Connection (three-way 90°), 'X' Connection (four-way 90°), 'V' Connection (two-way 120°) and 'Y' Connection (three-way 120°). Identify the desired connection and panel configuration and specify connectors as outlined below. A variety of panel configurations are shown on the following pages. Some configurations have more than one product code. An explanation of the product codes follow:

## PRODUCT CODE KEY EXAMPLE INCPT5053

<b>INCP</b>	panel connector
<b>T</b>	three-way connection
<b>5</b>	51" H panel
<b>0</b>	no panel
<b>5</b>	51" H panel
<b>3</b>	37" H panel



The prefix to the four digits in the product number represent the following: 'CP'-panel connector, 'L'-2-way connection, 'T'-3 way connection, 'X'-4-way connection, 'V'-2-way 120°connection and 'Y'-3-way 120°connection. The four digits represent the different heights of panels to be connected. Heights are represented by the first digit.

64" H panel	-6
51" H panel	-5
37" H panel	-3

To specify the correct panel junction, start with the highest panel and move clockwise. For example: To specify a 3-way connection comprised of 51" H and 37" H panels, start with the highest panel, 51" - 5. Proceed clockwise, 0 for no panels, 5 for 51" and 3 for 37". The code is 5053.

## FINISHES

Vertical trims are available in any of the colors shown in our current Paint Card and Fans plus textured paint finishes.

**NOTE: Tapered vertical trim is available in any of the colors shown in our current Paint Card and Fans plus textured paint finishes.**

If you don't find your configuration listed as standard product, send your request to [specials@inscapesolutions.com](mailto:specials@inscapesolutions.com) with a copy of the connection layout.

# Architecture

Frames and Screens  
3 1/2" Thick Standard Frames

# System

## PRODUCT CODE KEY EXAMPLE

INOF348-3F

**INOF** Inscape System Frame

**3** 37" H



**48** 48" W

**3F** 3 1/2" thick frame w/  
electrical cover plate

- Includes electrical cover kit at the beltline location painted in Eco Black
- 2" deep glide cap color of black or gray (gray default)
- 1 wire manager hanger included with frame
- Compatible with electrical launched December 2010 only
- A Beltline power track is to be specified in the beltline location
- Rectangular glides available for an upcharge of \$15 per frame

## NOTES

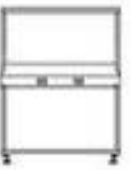
- **18" – 24" W frames do not come with electrical cutouts**
- **30" W frames come with only 1 cutout**
- **Top caps are to be ordered separately**

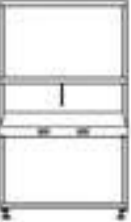
	Part number	H	W	Thickness	List price
	37" H Standard Frame				
	<b>INOF318-3F</b>	37"	18"	3 1/2"	\$317
	<b>INOF324-3F</b>	37"	24"	3 1/2"	\$322
	<b>INOF330-3F</b>	37"	30"	3 1/2"	\$339
	<b>INOF336-3F</b>	37"	36"	3 1/2"	\$345
	<b>INOF342-3F</b>	37"	42"	3 1/2"	\$351
	<b>INOF348-3F</b>	37"	48"	3 1/2"	\$357
	<b>INOF354-3F</b>	37"	54"	3 1/2"	\$360
	<b>INOF360-3F</b>	37"	60"	3 1/2"	\$373
	44" H Standard Frame				
	<b>INOF418-3F</b>	44"	18"	3 1/2"	\$347
	<b>INOF424-3F</b>	44"	24"	3 1/2"	\$348
	<b>INOF430-3F</b>	44"	30"	3 1/2"	\$353
	<b>INOF436-3F</b>	44"	36"	3 1/2"	\$360
	<b>INOF442-3F</b>	44"	42"	3 1/2"	\$368
	<b>INOF448-3F</b>	44"	48"	3 1/2"	\$375
	<b>INOF454-3F</b>	44"	54"	3 1/2"	\$377
	<b>INOF460-3F</b>	44"	60"	3 1/2"	\$380
	51" H Standard Frame				
	<b>INOF518-3F</b>	51"	18"	3 1/2"	\$362
	<b>INOF524-3F</b>	51"	24"	3 1/2"	\$368
	<b>INOF530-3F</b>	51"	30"	3 1/2"	\$377
	<b>INOF536-3F</b>	51"	36"	3 1/2"	\$389
	<b>INOF542-3F</b>	51"	42"	3 1/2"	\$398
	<b>INOF548-3F</b>	51"	48"	3 1/2"	\$415
	<b>INOF554-3F</b>	51"	54"	3 1/2"	\$420
	<b>INOF560-3F</b>	51"	60"	3 1/2"	\$434
	57" H Standard Frame				
	<b>INOF5718-3F</b>	57"	18"	3 1/2"	\$387
	<b>INOF5724-3F</b>	57"	24"	3 1/2"	\$397
	<b>INOF5730-3F</b>	57"	30"	3 1/2"	\$404
	<b>INOF5736-3F</b>	57"	36"	3 1/2"	\$424
	<b>INOF5742-3F</b>	57"	42"	3 1/2"	\$435
	<b>INOF5748-3F</b>	57"	48"	3 1/2"	\$452
	<b>INOF5754-3F</b>	57"	54"	3 1/2"	\$456
	<b>INOF5760-3F</b>	57"	60"	3 1/2"	\$471

# Architecture

Frames and Screens  
3 1/2" Thick Standard Frames

# System

## PRODUCT CODE KEY EXAMPLE

INOF348-3F

**INOF** Inscape System Frame

**3** 37" H

**48** 48" W

**3F** 3 1/2" thick frame w/  
electrical cover plate

- Includes electrical cover kit at the beltline location painted in Eco Black
- 2" deep glide cap color of black or gray (gray default)
- 1 wire manager hanger included with frame
- Compatible with electrical launched December 2010 only
- A Beltline power track is to be specified in the beltline location
- Rectangular glides available for an upcharge of \$15 per frame

## NOTES

- 18" – 24" W frames do not come with electrical cutouts
- 30" W frames come with only 1 cutout
- Top caps are to be ordered separately

	Part number	H	W	Thickness	List price	
	64" H Standard Frame	<b>INOF618-3F</b>	64"	18"	3 1/2"	\$403
		<b>INOF624-3F</b>	64"	24"	3 1/2"	\$416
		<b>INOF630-3F</b>	64"	30"	3 1/2"	\$428
		<b>INOF636-3F</b>	64"	36"	3 1/2"	\$445
		<b>INOF642-3F</b>	64"	42"	3 1/2"	\$463
		<b>INOF648-3F</b>	64"	48"	3 1/2"	\$479
		<b>INOF654-3F</b>	64"	54"	3 1/2"	\$484
		<b>INOF660-3F</b>	64"	60"	3 1/2"	\$502

# Architecture

Frames and Screens  
3 1/2" Thick Basic Frames

# System

## PRODUCT CODE KEY EXAMPLE

INOF348-3NPF

**INOF** Inscape System Frame

**3** 37" H



**48** 48" W

**3NPF** 3 1/2" thick frame non powered

- 2" deep glide cap color of black or gray (gray default)
- 24" H frame is equipped with hardware to attach to storage case
- 1 wire manager hanger included with frame
- Compatible with electrical launched after December 2010 only
- If powering a Basic frame, an Upper Deck power track kit is to be specified for all locations in the 3.5" thick frame
- Rectangular glides available for an upcharge of \$15 per frame

## NOTES

- Top caps are to be ordered separately

		Part number	H	W	Thickness	List price
	24" H Basic Frame	<b>INOF2418-3NPF</b>	24"	18"	3 1/2"	\$180
		<b>INOF2424-3NPF</b>	24"	24"	3 1/2"	\$184
		<b>INOF2430-3NPF</b>	24"	30"	3 1/2"	\$195
		<b>INOF2436-3NPF</b>	24"	36"	3 1/2"	\$199
		<b>INOF2442-3NPF</b>	24"	42"	3 1/2"	\$202
		<b>INOF2448-3NPF</b>	24"	48"	3 1/2"	\$205
		<b>INOF2454-3NPF</b>	24"	54"	3 1/2"	\$208
		<b>INOF2460-3NPF</b>	24"	60"	3 1/2"	\$211
	29" H Basic Frame	<b>INOF218-3NPF</b>	29"	18"	3 1/2"	\$227
		<b>INOF224-3NPF</b>	29"	24"	3 1/2"	\$229
		<b>INOF230-3NPF</b>	29"	30"	3 1/2"	\$243
		<b>INOF236-3NPF</b>	29"	36"	3 1/2"	\$247
		<b>INOF242-3NPF</b>	29"	42"	3 1/2"	\$250
		<b>INOF248-3NPF</b>	29"	48"	3 1/2"	\$252
		<b>INOF254-3NPF</b>	29"	54"	3 1/2"	\$254
		<b>INOF260-3NPF</b>	29"	60"	3 1/2"	\$256
	37" H Basic Frame	<b>INOF318-3NPF</b>	37"	18"	3 1/2"	\$238
		<b>INOF324-3NPF</b>	37"	24"	3 1/2"	\$243
		<b>INOF330-3NPF</b>	37"	30"	3 1/2"	\$253
		<b>INOF336-3NPF</b>	37"	36"	3 1/2"	\$256
		<b>INOF342-3NPF</b>	37"	42"	3 1/2"	\$262
		<b>INOF348-3NPF</b>	37"	48"	3 1/2"	\$263
		<b>INOF354-3NPF</b>	37"	54"	3 1/2"	\$265
		<b>INOF360-3NPF</b>	37"	60"	3 1/2"	\$270

# Architecture

Frames and Screens  
3 1/2" Thick Basic Frames

# System

## PRODUCT CODE KEY EXAMPLE

INOF348-3NPF

**INOF** Inscape System Frame

**3** 37" H





**48** 48" W

**3NPF** 3 1/2" thick frame non powered

- 2" deep glide cap color of black or gray (gray default)
- 24" H frame is equipped with hardware to attach to storage case
- 1 wire manager hanger included with frame
- Compatible with electrical launched after December 2010 only
- If powering a Basic frame, an Upper Deck power track kit is to be specified for all locations in the 3.5" thick frame
- Rectangular glides available for an upcharge of \$15 per frame

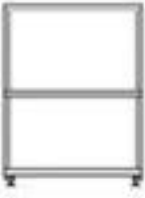
## NOTES

- Top caps are to be ordered separately

		Part number	H	W	Thickness	List price
	44" H Basic Frame	<b>INOF418-3NPF</b>	44"	18"	3 1/2"	\$266
		<b>INOF424-3NPF</b>	44"	24"	3 1/2"	\$270
		<b>INOF430-3NPF</b>	44"	30"	3 1/2"	\$273
		<b>INOF436-3NPF</b>	44"	36"	3 1/2"	\$277
		<b>INOF442-3NPF</b>	44"	42"	3 1/2"	\$281
		<b>INOF448-3NPF</b>	44"	48"	3 1/2"	\$286
		<b>INOF454-3NPF</b>	44"	54"	3 1/2"	\$290
		<b>INOF460-3NPF</b>	44"	60"	3 1/2"	\$294
	51" H Basic Frame	<b>INOF518-3NPF</b>	51"	18"	3 1/2"	\$283
		<b>INOF524-3NPF</b>	51"	24"	3 1/2"	\$287
		<b>INOF530-3NPF</b>	51"	30"	3 1/2"	\$292
		<b>INOF536-3NPF</b>	51"	36"	3 1/2"	\$299
		<b>INOF542-3NPF</b>	51"	42"	3 1/2"	\$309
		<b>INOF548-3NPF</b>	51"	48"	3 1/2"	\$320
		<b>INOF554-3NPF</b>	51"	54"	3 1/2"	\$324
		<b>INOF560-3NPF</b>	51"	60"	3 1/2"	\$332
	57" H Basic Frame	<b>INOF5718-3NPF</b>	57"	18"	3 1/2"	\$310
		<b>INOF5724-3NPF</b>	57"	24"	3 1/2"	\$318
		<b>INOF5730-3NPF</b>	57"	30"	3 1/2"	\$321
		<b>INOF5736-3NPF</b>	57"	36"	3 1/2"	\$333
		<b>INOF5742-3NPF</b>	57"	42"	3 1/2"	\$345
		<b>INOF5748-3NPF</b>	57"	48"	3 1/2"	\$355
		<b>INOF5754-3NPF</b>	57"	54"	3 1/2"	\$357
		<b>INOF5760-3NPF</b>	57"	60"	3 1/2"	\$370
	64" H Basic Frame	<b>INOF618-3NPF</b>	64"	18"	3 1/2"	\$328
		<b>INOF624-3NPF</b>	64"	24"	3 1/2"	\$339
		<b>INOF630-3NPF</b>	64"	30"	3 1/2"	\$340
		<b>INOF636-3NPF</b>	64"	36"	3 1/2"	\$357
		<b>INOF642-3NPF</b>	64"	42"	3 1/2"	\$374
		<b>INOF648-3NPF</b>	64"	48"	3 1/2"	\$383
		<b>INOF654-3NPF</b>	64"	54"	3 1/2"	\$385
		<b>INOF660-3NPF</b>	64"	60"	3 1/2"	\$400



# Architecture

Frames and Screens  
3 1/2" Thick Stack-on Frames

# System

## PRODUCT CODE KEY EXAMPLE

INSF048-3F

**INSF** Inscape System  
Stack-on Frame

**0** 6.75" H





**48** 48" W

**3F** 3 1/2" thick frame

- Fully welded stack on kits easily installed and removed to adjust panel heights
- Load bearing – only one overhead unit on frame higher than 64" H
- Stack on frames may span multiple frames  
\*See Application Guide for spanning guidelines

## NOTES

- Be sure to specify correct thickness of stack frame based on the frame it is being installed on
- May be stacked up to 91" H

		Part number	H	W	Thickness	List price
	6.75" H Single Stack-On	<b>INSF018-3F</b>	6.75"	18"	3 1/2"	\$157
		<b>INSF024-3F</b>	6.75"	24"	3 1/2"	\$161
		<b>INSF030-3F</b>	6.75"	30"	3 1/2"	\$162
		<b>INSF036-3F</b>	6.75"	36"	3 1/2"	\$166
		<b>INSF042-3F</b>	6.75"	42"	3 1/2"	\$169
		<b>INSF048-3F</b>	6.75"	48"	3 1/2"	\$174
		<b>INSF054-3F</b>	6.75"	54"	3 1/2"	\$175
		<b>INSF060-3F</b>	6.75"	60"	3 1/2"	\$179
	13.5" H Single Stack-On	<b>INSF118-3F</b>	13.5"	18"	3 1/2"	\$164
		<b>INSF124-3F</b>	13.5"	24"	3 1/2"	\$166
		<b>INSF130-3F</b>	13.5"	30"	3 1/2"	\$167
		<b>INSF136-3F</b>	13.5"	36"	3 1/2"	\$170
		<b>INSF142-3F</b>	13.5"	42"	3 1/2"	\$174
		<b>INSF148-3F</b>	13.5"	48"	3 1/2"	\$180
		<b>INSF154-3F</b>	13.5"	54"	3 1/2"	\$183
		<b>INSF160-3F</b>	13.5"	60"	3 1/2"	\$184
	20.25" H Single Stack-On	<b>INSF2018-3F</b>	20.25"	18"	3 1/2"	\$170
		<b>INSF2024-3F</b>	20.25"	24"	3 1/2"	\$175
		<b>INSF2030-3F</b>	20.25"	30"	3 1/2"	\$178
		<b>INSF2036-3F</b>	20.25"	36"	3 1/2"	\$183
		<b>INSF2042-3F</b>	20.25"	42"	3 1/2"	\$187
		<b>INSF2048-3F</b>	20.25"	48"	3 1/2"	\$191
		<b>INSF2054-3F</b>	20.25"	54"	3 1/2"	\$192
		<b>INSF2060-3F</b>	20.25"	60"	3 1/2"	\$195
	27" H Single Stack-On	<b>INSF218-3F</b>	27"	18"	3 1/2"	\$185
		<b>INSF224-3F</b>	27"	24"	3 1/2"	\$194
		<b>INSF230-3F</b>	27"	30"	3 1/2"	\$195
		<b>INSF236-3F</b>	27"	36"	3 1/2"	\$199
		<b>INSF242-3F</b>	27"	42"	3 1/2"	\$201
		<b>INSF248-3F</b>	27"	48"	3 1/2"	\$207
		<b>INSF254-3F</b>	27"	54"	3 1/2"	\$208
		<b>INSF260-3F</b>	27"	60"	3 1/2"	\$209

# Architecture

## Frames and Screens

### 3 1/2" Thick Double Glazed Stack-on Frames

# System

#### PRODUCT CODE KEY EXAMPLE

INSTGL24-3F

**INST** Inscape System  
Stack-on Frame

**GL** double glaze

**24** 24" W

**3F** 3 1/2" thick frame

- Clear and frosted acrylic options available.
- Must only be installed in the top location
- Is not load bearing.
- Stack on Double Glaze may span two frames.  
\*See *Application Guide for spanning guidelines*
- 24" to 48" W kits consist of welded frames
- 54" to 96" W kits are kitted and must be assembled onsite

#### NOTES

Be sure to specify correct thickness of stack frame based on the frame it is being installed on.

In order to get a total cost on products when upcharges are present take the list price of the product number and add the upcharge cost shown to the list price.

For example:

Product INSTGL24-3F in Frosted Acrylic would be \$474 +\$84

		Part number	H	W	Thickness	Clear acrylic	Frosted acrylic	Accent paint
	13.5" H Double Glaze Stack-On Acrylic	<b>INSTGL24-3F</b>	13.5"	24"	3 1/2"	\$474	+\$84	+\$50
		<b>INSTGL30-3F</b>	13.5"	30"	3 1/2"	\$532	+\$92	+\$56
		<b>INSTGL36-3F</b>	13.5"	36"	3 1/2"	\$607	+\$103	+\$63
		<b>INSTGL42-3F</b>	13.5"	42"	3 1/2"	\$658	+\$114	+\$67
		<b>INSTGL48-3F</b>	13.5"	48"	3 1/2"	\$726	+\$126	+\$74
		<b>INSTGL54-3F</b>	13.5"	54"	3 1/2"	\$795	+\$124	+\$84
		<b>INSTGL60-3F</b>	13.5"	60"	3 1/2"	\$863	+\$135	+\$89
		<b>INSTGL66-3F</b>	13.5"	66"	3 1/2"	\$931	+\$160	+\$96
		<b>INSTGL72-3F</b>	13.5"	72"	3 1/2"	\$958	+\$164	+\$99
		<b>INSTGL78-3F</b>	13.5"	78"	3 1/2"	\$985	+\$168	+\$101
		<b>INSTGL84-3F</b>	13.5"	84"	3 1/2"	\$1015	+\$171	+\$103
		<b>INSTGL90-3F</b>	13.5"	90"	3 1/2"	\$1043	+\$178	+\$106
		<b>INSTGL96-3F</b>	13.5"	96"	3 1/2"	\$1069	+\$182	+\$108

# Architecture

Frames and Screens  
2 3/4" Thick Standard Frames

# System

## PRODUCT CODE KEY EXAMPLE



INOF342-2F

<b>INOF</b>	Inscape System Frame
<b>3</b>	37" H
<b>42</b>	42" W
<b>2F</b>	2 3/4" thick standard frame

- Includes electrical cover kit at the beltline location painted in Eco Black
- 2" deep glide cap color of black or gray (gray default)
- 1 wire manager hanger included with frame
- Compatible with electrical launched after December 2010 only
- A Beltline power track is to be specified in the beltline location
- See Application guide for restrictions with cabling
- Rectangular glides available for an upcharge of \$15 per frame

## NOTES

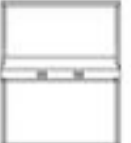
- 18" – 24" W frames do not come with electrical cutouts
- 30" W frames come with 1 electrical cutout
- 27" H tiles cannot be mounted in bottom position on a 2.75" thick standard frame
- Tiles cannot be placed over cover kit (beltline location) on 2.75" frame
- Top caps are to be ordered separately

	Part number	H	W	Thickness	List price
	37" H Standard Frame				
	<b>INOF318-2F</b>	37"	18"	2 3/4"	\$317
	<b>INOF324-2F</b>	37"	24"	2 3/4"	\$322
	<b>INOF330-2F</b>	37"	30"	2 3/4"	\$339
	<b>INOF336-2F</b>	37"	36"	2 3/4"	\$345
	<b>INOF342-2F</b>	37"	42"	2 3/4"	\$351
	<b>INOF348-2F</b>	37"	48"	2 3/4"	\$357
	<b>INOF354-2F</b>	37"	54"	2 3/4"	\$360
	<b>INOF360-2F</b>	37"	60"	2 3/4"	\$373
	44" H Standard Frame				
	<b>INOF418-2F</b>	44"	18"	2 3/4"	\$347
	<b>INOF424-2F</b>	44"	24"	2 3/4"	\$348
	<b>INOF430-2F</b>	44"	30"	2 3/4"	\$353
	<b>INOF436-2F</b>	44"	36"	2 3/4"	\$360
	<b>INOF442-2F</b>	44"	42"	2 3/4"	\$368
	<b>INOF448-2F</b>	44"	48"	2 3/4"	\$375
	<b>INOF454-2F</b>	44"	54"	2 3/4"	\$377
	<b>INOF460-2F</b>	44"	60"	2 3/4"	\$380
	51" H Standard Frame				
	<b>INOF518-2F</b>	51"	18"	2 3/4"	\$362
	<b>INOF524-2F</b>	51"	24"	2 3/4"	\$368
	<b>INOF530-2F</b>	51"	30"	2 3/4"	\$377
	<b>INOF536-2F</b>	51"	36"	2 3/4"	\$389
	<b>INOF542-2F</b>	51"	42"	2 3/4"	\$398
	<b>INOF548-2F</b>	51"	48"	2 3/4"	\$415
	<b>INOF554-2F</b>	51"	54"	2 3/4"	\$420
	<b>INOF560-2F</b>	51"	60"	2 3/4"	\$434

# Architecture

Frames and Screens  
2 3/4" Thick Standard Frames

# System

## PRODUCT CODE KEY EXAMPLE



INOF342-2F

<b>INOF</b>	Inscape System Frame
<b>3</b>	37" H
<b>42</b>	42" W
<b>2F</b>	2 3/4" thick standard frame

- Includes electrical cover kit at the beltline location painted in Eco Black
- 2" deep glide cap color of black or gray (gray default)
- 1 wire manager hanger included with frame
- Compatible with electrical launched after December 2010 only
- A Beltline power track is to be specified in the beltline location
- See Application guide for restrictions with cabling
- Rectangular glides available for an upcharge of \$15 per frame

## NOTES

- 18" – 24" W frames do not come with electrical cutouts
- 30" W frames come with 1 electrical cutout
- 27" H tiles cannot be mounted in bottom position on a 2.75" thick standard frame
- Tiles cannot be placed over cover kit (beltline location) on 2.75" frame
- Top caps are to be ordered separately

	Part number	H	W	Thickness	List price
	57" H Standard Frame				
	<b>INOF5718-2F</b>	57"	18"	2 3/4"	\$387
	<b>INOF5724-2F</b>	57"	24"	2 3/4"	\$397
	<b>INOF5730-2F</b>	57"	30"	2 3/4"	\$404
	<b>INOF5736-2F</b>	57"	36"	2 3/4"	\$424
	<b>INOF5742-2F</b>	57"	42"	2 3/4"	\$435
	<b>INOF5748-2F</b>	57"	48"	2 3/4"	\$452
	<b>INOF5754-2F</b>	57"	54"	2 3/4"	\$456
	<b>INOF5760-2F</b>	57"	60"	2 3/4"	\$471
	64" H Standard Frame				
	<b>INOF618-2F</b>	64"	18"	2 3/4"	\$403
	<b>INOF624-2F</b>	64"	24"	2 3/4"	\$416
	<b>INOF630-2F</b>	64"	30"	2 3/4"	\$428
	<b>INOF636-2F</b>	64"	36"	2 3/4"	\$445
	<b>INOF642-2F</b>	64"	42"	2 3/4"	\$463
	<b>INOF648-2F</b>	64"	48"	2 3/4"	\$479
	<b>INOF654-2F</b>	64"	54"	2 3/4"	\$484
	<b>INOF660-2F</b>	64"	60"	2 3/4"	\$502

# Architecture

Frames and Screens  
2 3/4" Thick Basic Frames

# System

## PRODUCT CODE KEY EXAMPLE

INOF342-2NPF

**INOF** Inscape System Frame

**3** 37" H



**42** 42" W

**2NPF** 2 3/4" thick frame non powered

- 2" deep glide cap color of black or gray (gray default)
- 24" H frame is equipped with hardware to attach to storage case
- 1 wire manager hanger included with frame
- Compatible with electrical launched after December 2010 only
- If powering a Basic frame, an Upper Deck power track kit is to be specified for all locations in the 2.75" thick frame
- Rectangular glides available for an upcharge of \$15 per frame

## NOTES

- 18" – 24" W frames do not come with electrical cutouts
- 30" W frames come with 1 electrical cutout
- Top caps are to be ordered separately

		Part number	H	W	Thickness	List price
	24" H Basic Frame	<b>INOF2418-2NPF</b>	24"	18"	2 3/4"	\$180
		<b>INOF2424-2NPF</b>	24"	24"	2 3/4"	\$184
		<b>INOF2430-2NPF</b>	24"	30"	2 3/4"	\$195
		<b>INOF2436-2NPF</b>	24"	36"	2 3/4"	\$199
		<b>INOF2442-2NPF</b>	24"	42"	2 3/4"	\$202
		<b>INOF2448-2NPF</b>	24"	48"	2 3/4"	\$205
		<b>INOF2454-2NPF</b>	24"	54"	2 3/4"	\$208
		<b>INOF2460-2NPF</b>	24"	60"	2 3/4"	\$211
	29" H Basic Frame	<b>INOF218-2NPF</b>	29"	18"	2 3/4"	\$227
		<b>INOF224-2NPF</b>	29"	24"	2 3/4"	\$229
		<b>INOF230-2NPF</b>	29"	30"	2 3/4"	\$243
		<b>INOF236-2NPF</b>	29"	36"	2 3/4"	\$247
		<b>INOF242-2NPF</b>	29"	42"	2 3/4"	\$250
		<b>INOF248-2NPF</b>	29"	48"	2 3/4"	\$252
		<b>INOF254-2NPF</b>	29"	54"	2 3/4"	\$254
		<b>INOF260-2NPF</b>	29"	60"	2 3/4"	\$256
	37" H Basic Frame	<b>INOF318-2NPF</b>	37"	18"	2 3/4"	\$238
		<b>INOF324-2NPF</b>	37"	24"	2 3/4"	\$243
		<b>INOF330-2NPF</b>	37"	30"	2 3/4"	\$253
		<b>INOF336-2NPF</b>	37"	36"	2 3/4"	\$256
		<b>INOF342-2NPF</b>	37"	42"	2 3/4"	\$262
		<b>INOF348-2NPF</b>	37"	48"	2 3/4"	\$263
		<b>INOF354-2NPF</b>	37"	54"	2 3/4"	\$265
		<b>INOF360-2NPF</b>	37"	60"	2 3/4"	\$270

# Architecture

Frames and Screens  
2 3/4" Thick Basic Frames

# System

## PRODUCT CODE KEY EXAMPLE

INOF342-2NPF

**INOF** Inscape System Frame

**3** 37" H





**42** 42" W

**2NPF** 2 3/4" thick frame non powered

- 2" deep glide cap color of black or gray (gray default)
- 24" H frame is equipped with hardware to attach to storage case
- 1 wire manager hanger included with frame
- Compatible with electrical launched after December 2010 only
- If powering a Basic frame, an Upper Deck power track kit is to be specified for all locations in the 2.75" thick frame
- Rectangular glides available for an upcharge of \$15 per frame

## NOTES

- 18" – 24" W frames do not come with electrical cutouts
- 30" W frames come with 1 electrical cutout
- Top caps are to be ordered separately

		Part number	H	W	Thickness	List price
	44" H Basic Frame	<b>INOF418-2NPF</b>	44"	18"	2 3/4"	\$266
		<b>INOF424-2NPF</b>	44"	24"	2 3/4"	\$270
		<b>INOF430-2NPF</b>	44"	30"	2 3/4"	\$273
		<b>INOF436-2NPF</b>	44"	36"	2 3/4"	\$277
		<b>INOF442-2NPF</b>	44"	42"	2 3/4"	\$281
		<b>INOF448-2NPF</b>	44"	48"	2 3/4"	\$286
		<b>INOF454-2NPF</b>	44"	54"	2 3/4"	\$290
		<b>INOF460-2NPF</b>	44"	60"	2 3/4"	\$294
	51" H Basic Frame	<b>INOF518-2NPF</b>	51"	18"	2 3/4"	\$283
		<b>INOF524-2NPF</b>	51"	24"	2 3/4"	\$287
		<b>INOF530-2NPF</b>	51"	30"	2 3/4"	\$292
		<b>INOF536-2NPF</b>	51"	36"	2 3/4"	\$299
		<b>INOF542-2NPF</b>	51"	42"	2 3/4"	\$309
		<b>INOF548-2NPF</b>	51"	48"	2 3/4"	\$320
		<b>INOF554-2NPF</b>	51"	54"	2 3/4"	\$324
		<b>INOF560-2NPF</b>	51"	60"	2 3/4"	\$332
	57" H Basic Frame	<b>INOF5718-2NPF</b>	57"	18"	2 3/4"	\$310
		<b>INOF5724-2NPF</b>	57"	24"	2 3/4"	\$318
		<b>INOF5730-2NPF</b>	57"	30"	2 3/4"	\$321
		<b>INOF5736-2NPF</b>	57"	36"	2 3/4"	\$333
		<b>INOF5742-2NPF</b>	57"	42"	2 3/4"	\$345
		<b>INOF5748-2NPF</b>	57"	48"	2 3/4"	\$355
		<b>INOF5754-2NPF</b>	57"	54"	2 3/4"	\$357
		<b>INOF5760-2NPF</b>	57"	60"	2 3/4"	\$370
	64" H Basic Frame	<b>INOF618-2NPF</b>	64"	18"	2 3/4"	\$328
		<b>INOF624-2NPF</b>	64"	24"	2 3/4"	\$339
		<b>INOF630-2NPF</b>	64"	30"	2 3/4"	\$340
		<b>INOF636-2NPF</b>	64"	36"	2 3/4"	\$357
		<b>INOF642-2NPF</b>	64"	42"	2 3/4"	\$374
		<b>INOF648-2NPF</b>	64"	48"	2 3/4"	\$383
		<b>INOF654-2NPF</b>	64"	54"	2 3/4"	\$385
		<b>INOF660-2NPF</b>	64"	60"	2 3/4"	\$400

# Architecture

Frames and Screens  
2 3/4" Thick Stack-on Frames

# System

## PRODUCT CODE KEY EXAMPLE





INSF048-2F

<b>INSF</b>	Inscape System Stack-on Frame
<b>0</b>	6.75" H
<b>48</b>	48" W
<b>2F</b>	2 3/4" thick fram

- Fully welded stack on kits easily installed and removed to adjust panel height.
- Load bearing – only one overhead unit on frame higher than 64" H only.
- Stack-on frames may span multiple frames.  
\*See Application Guide for spanning guidelines.

## NOTES

- Be sure to specify correct thickness of stack frame based on the frame it is being installed on
- May be stacked up to 91" H

		Part number	H	W	Thickness	List price
	6.75" H Single Stack-On	<b>INSF018-2F</b>	6.75"	18"	2 3/4"	\$157
		<b>INSF024-2F</b>	6.75"	24"	2 3/4"	\$161
		<b>INSF030-2F</b>	6.75"	30"	2 3/4"	\$162
		<b>INSF036-2F</b>	6.75"	36"	2 3/4"	\$166
		<b>INSF042-2F</b>	6.75"	42"	2 3/4"	\$169
		<b>INSF048-2F</b>	6.75"	48"	2 3/4"	\$174
		<b>INSF054-2F</b>	6.75"	54"	2 3/4"	\$175
		<b>INSF060-2F</b>	6.75"	60"	2 3/4"	\$179
	13.5" H Single Stack-On	<b>INSF118-2F</b>	13.5"	18"	2 3/4"	\$164
		<b>INSF124-2F</b>	13.5"	24"	2 3/4"	\$166
		<b>INSF130-2F</b>	13.5"	30"	2 3/4"	\$167
		<b>INSF136-2F</b>	13.5"	36"	2 3/4"	\$170
		<b>INSF142-2F</b>	13.5"	42"	2 3/4"	\$174
		<b>INSF148-2F</b>	13.5"	48"	2 3/4"	\$180
		<b>INSF154-2F</b>	13.5"	54"	2 3/4"	\$183
		<b>INSF160-2F</b>	13.5"	60"	2 3/4"	\$184
	20.25" H Single Stack-On	<b>INSF2018-2F</b>	20.25"	18"	2 3/4"	\$170
		<b>INSF2024-2F</b>	20.25"	24"	2 3/4"	\$175
		<b>INSF2030-2F</b>	20.25"	30"	2 3/4"	\$178
		<b>INSF2036-2F</b>	20.25"	36"	2 3/4"	\$183
		<b>INSF2042-2F</b>	20.25"	42"	2 3/4"	\$187
		<b>INSF2048-2F</b>	20.25"	48"	2 3/4"	\$191
		<b>INSF2054-2F</b>	20.25"	54"	2 3/4"	\$192
		<b>INSF2060-2F</b>	20.25"	60"	2 3/4"	\$195
	27" H Single Stack-On	<b>INSF218-2F</b>	27"	18"	2 3/4"	\$185
		<b>INSF224-2F</b>	27"	24"	2 3/4"	\$194
		<b>INSF230-2F</b>	27"	30"	2 3/4"	\$195
		<b>INSF236-2F</b>	27"	36"	2 3/4"	\$199
		<b>INSF242-2F</b>	27"	42"	2 3/4"	\$201
		<b>INSF248-2F</b>	27"	48"	2 3/4"	\$207
		<b>INSF254-2F</b>	27"	54"	2 3/4"	\$208
		<b>INSF260-2F</b>	27"	60"	2 3/4"	\$209

# Architecture

## Frames and Screens

### 2 3/4" Thick Double Glazed Stack-on Frames

# System

#### PRODUCT CODE KEY EXAMPLE

INSTGL24-2F

<b>INST</b>	Inscape System Stack-on Frame
<b>GL</b>	double glaze
<b>24</b>	24" W
<b>2F</b>	2 3/4" thick frame

- Clear and frosted acrylic options available
- Must only be installed in the top location
- Is not load bearing
- Stack on Double Glaze may span two frames.  
\*See *Application Guide for spanning guidelines*
- 24" to 48" W kits consist of welded frames
- 54" to 96" W kits are kitted and must be assembled onsite

#### NOTES

Be sure to specify correct thickness of stack frame based on the frame it is being installed on.

In order to get a total cost on products when upcharges are present take the list price of the product number and add the upcharge cost shown to the list price.

For example:

Product INSTGL24-2F in Frosted Acrylic would be \$462 +\$84

		Part number	H	W	Thickness	Clear acrylic	Frosted acrylic	Accent paint
	13.5" H Double Glaze Stack-On Acrylic	<b>INSTGL24-2F</b>	13.5"	24"	2 3/4"	\$462	+\$84	+\$49
		<b>INSTGL30-2F</b>	13.5"	30"	2 3/4"	\$521	+\$92	+\$54
		<b>INSTGL36-2F</b>	13.5"	36"	2 3/4"	\$596	+\$103	+\$61
		<b>INSTGL42-2F</b>	13.5"	42"	2 3/4"	\$645	+\$114	+\$66
		<b>INSTGL48-2F</b>	13.5"	48"	2 3/4"	\$714	+\$126	+\$73
		<b>INSTGL54-2F</b>	13.5"	54"	2 3/4"	\$783	+\$124	+\$83
		<b>INSTGL60-2F</b>	13.5"	60"	2 3/4"	\$862	+\$135	+\$89
		<b>INSTGL66-2F</b>	13.5"	66"	2 3/4"	\$916	+\$160	+\$94
		<b>INSTGL72-2F</b>	13.5"	72"	2 3/4"	\$944	+\$164	+\$97
		<b>INSTGL78-2F</b>	13.5"	78"	2 3/4"	\$974	+\$168	+\$100
		<b>INSTGL84-2F</b>	13.5"	84"	2 3/4"	\$999	+\$171	+\$102
		<b>INSTGL90-2F</b>	13.5"	90"	2 3/4"	\$1030	+\$178	+\$105
		<b>INSTGL96-2F</b>	13.5"	96"	2 3/4"	\$1058	+\$182	+\$107



# Architecture

Frames and Screens  
1 1/2" Thick Segmented Screens

# System

## PRODUCT CODE KEY EXAMPLE

SS378

<b>SS</b>	Segmented Screen
<b>37</b>	37" H
<b>18</b>	18" W





- Segmented screens may only be attached to the 3 1/2" thick tapered trim frames or 1 1/2" thick screens (brackets specified separately)
- These screens are not freestanding
- Screens include 2" dia glide with 1 1/2" height adjustability – optional gray (default) or black
- Segmented screens come fully trimmed
- All segments are optioned as one fabric pattern only
- Segments are tackable
- Fabric is applied in a railroad orientation
- Available with round glides only

## NOTES

The following fabrics are not available on segmented screens; U5005 Sprite Snow

In order to get a total cost on products when upcharges are present take the list price of the product number and add the upcharge cost shown to the list price.

For example:  
Product SS3718 in Grade 5 Fabric would be \$512 +\$91

	Part number	H	W	Wt (lbs)	Grade 1/ COM/ Base price	Grade 2	Grade 3	Grade 4	Grade 5	Grade 6	Grade 7	Grade 8	Accent paint
 37" H Segmented Screen	<b>SS3718</b>	37"	18"	9	\$512	+\$31	+\$44	—	+\$91	+\$194	+\$295	—	+\$53
	<b>SS3724</b>	37"	24"	10	\$538	+\$32	+\$50	—	+\$97	+\$206	+\$314	—	+\$57
	<b>SS3730</b>	37"	30"	12	\$583	+\$39	+\$60	—	+\$118	+\$237	+\$356	—	+\$60
	<b>SS3736</b>	37"	36"	14	\$630	+\$50	+\$77	—	+\$139	+\$272	+\$402	—	+\$64
	<b>SS3742</b>	37"	42"	15	\$675	+\$59	+\$92	—	+\$162	+\$303	+\$449	—	+\$69
	<b>SS3748</b>	37"	48"	17	\$701	+\$59	+\$92	—	+\$164	+\$318	+\$458	—	+\$72
	<b>SS3754</b>	37"	54"	19	\$729	+\$59	+\$92	—	+\$164	+\$332	+\$458	—	+\$74
	<b>SS3760</b>	37"	60"	21	\$754	+\$59	+\$91	—	+\$167	+\$346	+\$484	—	+\$77
 44" H Segmented Screen	<b>SS4418</b>	44"	18"	11	\$540	+\$34	+\$51	—	+\$102	+\$213	+\$323	—	+\$57
	<b>SS4424</b>	44"	24"	12	\$570	+\$36	+\$57	—	+\$106	+\$223	+\$341	—	+\$59
	<b>SS4430</b>	44"	30"	14	\$621	+\$50	+\$74	—	+\$134	+\$265	+\$395	—	+\$64
	<b>SS4436</b>	44"	36"	15	\$671	+\$60	+\$92	—	+\$164	+\$306	+\$449	—	+\$69
	<b>SS4442</b>	44"	42"	17	\$725	+\$72	+\$108	—	+\$187	+\$340	+\$501	—	+\$74
	<b>SS4448</b>	44"	48"	19	\$753	+\$71	+\$108	—	+\$188	+\$349	+\$510	—	+\$77
	<b>SS4454</b>	44"	54"	21	\$783	+\$72	+\$112	—	+\$194	+\$360	+\$526	—	+\$83
	<b>SS4460</b>	44"	60"	23	\$812	+\$72	+\$111	—	+\$192	+\$368	+\$535	—	+\$85
 51" H Segmented Screen	<b>SS5118</b>	51"	18"	12	\$602	+\$35	+\$60	—	+\$124	+\$248	+\$371	—	+\$62
	<b>SS5124</b>	51"	24"	13	\$627	+\$46	+\$63	—	+\$127	+\$262	+\$382	—	+\$64
	<b>SS5130</b>	51"	30"	15	\$687	+\$57	+\$87	—	+\$159	+\$303	+\$445	—	+\$70
	<b>SS5136</b>	51"	36"	18	\$749	+\$71	+\$106	—	+\$185	+\$346	+\$506	—	+\$77
	<b>SS5142</b>	51"	42"	20	\$810	+\$87	+\$129	—	+\$216	+\$362	+\$569	—	+\$85
	<b>SS5148</b>	51"	48"	22	\$844	+\$87	+\$129	—	+\$216	+\$383	+\$569	—	+\$88
	<b>SS5154</b>	51"	54"	24	\$877	+\$87	+\$129	—	+\$216	+\$400	+\$569	—	+\$91
	<b>SS5160</b>	51"	60"	26	\$912	+\$88	+\$131	—	+\$223	+\$427	+\$616	—	+\$94
 64" H Segmented Screen	<b>SS6418</b>	64"	18"	12	\$708	+\$54	+\$79	—	+\$148	+\$295	+\$441	—	+\$72
	<b>SS6424</b>	64"	24"	16	\$719	+\$56	+\$87	—	+\$159	+\$308	+\$456	—	+\$73
	<b>SS6430</b>	64"	30"	19	\$793	+\$76	+\$114	—	+\$198	+\$367	+\$535	—	+\$83
	<b>SS6436</b>	64"	36"	21	\$869	+\$94	+\$140	—	+\$238	+\$427	+\$615	—	+\$90
	<b>SS6442</b>	64"	42"	23	\$947	+\$112	+\$167	—	+\$276	+\$485	+\$694	—	+\$98
	<b>SS6448</b>	64"	48"	26	\$988	+\$111	+\$168	—	+\$279	+\$503	+\$714	—	+\$101
	<b>SS6454</b>	64"	54"	29	\$1031	+\$111	+\$169	—	+\$281	+\$518	+\$732	—	+\$105
	<b>SS6460</b>	64"	60"	32	\$1073	+\$112	+\$168	—	+\$285	+\$535	+\$750	—	+\$110

# Architecture

## Frames and Screens

### 1 1/2" Thick Glazed Segmented Screens

# System

#### PRODUCT CODE KEY EXAMPLE

SSG6424

<b>SS</b>	Segmented Screen
<b>G</b>	Glazed
<b>64</b>	64" H
<b>42</b>	42" W

- Glazed Segmented Screens may only be attached to the 3 1/2" thick tapered trim frames or 1 1/2" thick screens (brackets specified separately)
- These screens are not freestanding
- Screens include 2" dia glide with 1 1/2" height adjustability – optional gray (default) or black
- Segmented screens come fully trimmed
- Clear acrylic is included in the top 13.5" segment
- All other segments are optioned as one fabric pattern
- Fabric segments are tackable
- Fabric is applied in a railroad orientation
- Available with round glides only

#### NOTES

The following fabrics are not available on segmented screens; U5005 Sprite Snow

In order to get a total cost on products when upcharges are present take the list price of the product number and add the upcharge cost shown to the list price.

For example:

Product SSG6424 in Grade 5 Fabric would be \$799 +\$137

Part number	H	W	Wt (lbs)	Grade 1/ COM/ Base price	Grade 2	Grade 3	Grade 4	Grade 5	Grade 6	Grade 7	Grade 8	Accent paint
<b>SSG6424</b>	64"	24"	16	\$799	+\$44	+\$64	—	+\$137	+\$291	+\$457	—	+\$84
<b>SSG6430</b>	64"	30"	19	\$887	+\$57	+\$88	—	+\$170	+\$351	+\$533	—	+\$92
<b>SSG6436</b>	64"	36"	21	\$974	+\$72	+\$111	—	+\$201	+\$403	+\$605	—	+\$100
<b>SSG6442</b>	64"	42"	23	\$1059	+\$87	+\$131	—	+\$235	+\$457	+\$679	—	+\$107
<b>SSG6448</b>	64"	48"	26	\$1163	+\$87	+\$131	—	+\$246	+\$486	+\$726	—	+\$119
<b>SSG6454</b>	64"	54"	29	\$1264	+\$88	+\$131	—	+\$251	+\$510	+\$769	—	+\$129
<b>SSG6460</b>	64"	60"	32	\$1365	+\$88	+\$131	—	+\$251	+\$529	+\$769	—	+\$139



64" H with Clear Acrylic

# Architecture

Frames and Screens  
1 1/2" Thick Monolithic Screens

# System

## PRODUCT CODE KEY EXAMPLE

MS3718

**MS** Monolithic Screen

**37** 37" H

**18** 18" W

- Monolithic screens may only be attached to the 3 1/2" thick tapered trim frames or 1 1/2" thick screens (brackets specified separately)
- These screens are not freestanding
- Screens include 2" dia glide with 1 1/2" height adjustability – optional gray (default) or black
- Monolithic screens come fully trimmed
- Fabric screens are tackable
- Fabric is applied in a railroad orientation
- Clear and White fluted material is polycarbonate and has naturally occurring variances in the material
- Available with round glides only





## NOTES

The following fabrics are not available on monolithic screens; U5005 Sprite Snow

In order to get a total cost on products when upcharges are present take the list price of the product number and add the upcharge cost shown to the list price.

For example:

Product MS3718 in Grade 5 Fabric would be \$429 +\$88

	Part number	H	W	Wt (lbs)	Grade 1/ COM/ Base price	Grade 2	Grade 3	Grade 4	Grade 5	Grade 6	Grade 7	Grade 8	Clear fluted polycarbonate	White fluted polycarbonate	Accent paint
 37" H Monolithic Screen	<b>MS3718</b>	37"	18"	9	\$429	+\$31	+\$46	—	+\$88	+\$174	+\$262	—	—	—	+\$46
	<b>MS3724</b>	37"	24"	10	\$463	+\$31	+\$46	—	+\$88	+\$185	+\$274	—	+\$86	+\$86	+\$49
	<b>MS3730</b>	37"	30"	11	\$504	+\$37	+\$59	—	+\$105	+\$211	+\$316	—	+\$59	+\$59	+\$53
	<b>MS3736</b>	37"	36"	13	\$546	+\$50	+\$76	—	+\$129	+\$242	+\$356	—	+\$34	+\$34	+\$57
	<b>MS3742</b>	37"	42"	15	\$584	+\$57	+\$89	—	+\$152	+\$277	+\$402	—	+\$29	+\$29	+\$60
	<b>MS3748</b>	37"	48"	16	\$607	+\$58	+\$90	—	+\$153	+\$282	+\$412	—	+\$48	+\$48	+\$63
	<b>MS3754</b>	37"	54"	18	\$633	+\$60	+\$90	—	+\$156	+\$291	+\$426	—	—	—	+\$65
	<b>MS3760</b>	37"	60"	19	\$658	+\$64	+\$89	—	+\$157	+\$295	+\$435	—	—	—	+\$67
 44" H Monolithic Screen	<b>MS4418</b>	44"	18"	10	\$459	+\$36	+\$53	—	+\$100	+\$196	+\$290	—	—	—	+\$49
	<b>MS4424</b>	44"	24"	11	\$494	+\$42	+\$53	—	+\$111	+\$207	+\$303	—	+\$71	+\$71	+\$52
	<b>MS4430</b>	44"	30"	13	\$542	+\$48	+\$69	—	+\$127	+\$240	+\$353	—	+\$60	+\$60	+\$57
	<b>MS4436</b>	44"	36"	15	\$591	+\$56	+\$87	—	+\$146	+\$274	+\$400	—	+\$51	+\$51	+\$61
	<b>MS4442</b>	44"	42"	16	\$636	+\$69	+\$104	—	+\$174	+\$314	+\$453	—	+\$51	+\$51	+\$65
	<b>MS4448</b>	44"	48"	18	\$663	+\$71	+\$103	—	+\$175	+\$319	+\$463	—	+\$67	+\$67	+\$67
	<b>MS4454</b>	44"	54"	20	\$688	+\$73	+\$102	—	+\$178	+\$327	+\$475	—	—	—	+\$71
	<b>MS4460</b>	44"	60"	22	\$714	+\$76	+\$104	—	+\$180	+\$333	+\$488	—	—	—	+\$73
 51" H Monolithic Screen	<b>MS5118</b>	51"	18"	11	\$488	+\$42	+\$59	—	+\$111	+\$213	+\$316	—	—	—	+\$51
	<b>MS5124</b>	51"	24"	13	\$526	+\$48	+\$61	—	+\$114	+\$223	+\$332	—	+\$99	+\$99	+\$56
	<b>MS5130</b>	51"	30"	15	\$579	+\$54	+\$85	—	+\$142	+\$266	+\$389	—	+\$91	+\$91	+\$60
	<b>MS5136</b>	51"	36"	17	\$634	+\$64	+\$101	—	+\$171	+\$310	+\$449	—	+\$86	+\$86	+\$65
	<b>MS5142</b>	51"	42"	19	\$686	+\$83	+\$120	—	+\$200	+\$353	+\$505	—	+\$48	+\$48	+\$70
	<b>MS5148</b>	51"	48"	21	\$714	+\$84	+\$121	—	+\$205	+\$361	+\$517	—	+\$36	+\$36	+\$73
	<b>MS5154</b>	51"	54"	23	\$744	+\$87	+\$121	—	+\$207	+\$368	+\$530	—	—	—	+\$76
	<b>MS5160</b>	51"	60"	25	\$771	+\$89	+\$121	—	+\$215	+\$378	+\$540	—	—	—	+\$81
 64" H Monolithic Screen	<b>MS6418</b>	64"	18"	11	\$515	+\$51	+\$71	—	+\$129	+\$239	+\$348	—	—	—	+\$54
	<b>MS6424</b>	64"	24"	13	\$563	+\$60	+\$85	—	+\$148	+\$272	+\$394	—	—	—	+\$59
	<b>MS6430</b>	64"	30"	15	\$626	+\$52	+\$79	—	+\$142	+\$295	+\$405	—	—	—	+\$64
	<b>MS6436</b>	64"	36"	17	\$753	+\$34	+\$154	—	+\$247	+\$331	+\$588	—	—	—	+\$77
	<b>MS6442</b>	64"	42"	19	\$788	+\$67	+\$157	—	+\$249	+\$375	+\$602	—	—	—	+\$83
	<b>MS6448</b>	64"	48"	21	\$822	+\$102	+\$161	—	+\$249	+\$415	+\$615	—	—	—	+\$86

# Architecture

Frames and Screens  
1 1/2" Thick Monolithic Screens

# System

## PRODUCT CODE KEY EXAMPLE

MS7118

<b>MS</b>	Monolithic Screen
<b>71</b>	71" H
<b>18</b>	18" W

- Monolithic screens may only be attached to the 3 1/2" thick tapered trim frames or 1 1/2" thick screens (brackets specified separately)
- These screens are not freestanding
- Screens include 2" dia glide with 1 1/2" height adjustability – optional gray (default) or black
- Monolithic screens come fully trimmed
- Fabric screens are tackable
- Fabric is applied in a railroad orientation
- Clear and White fluted material is polycarbonate and has naturally occurring variances in the material
- Available with round glides only

## NOTES

The following fabrics are not available on monolithic screens; U5005 Sprite Snow

In order to get a total cost on products when upcharges are present take the list price of the product number and add the upcharge cost shown to the list price.

For example:  
Product MS7118 in Grade 5 Fabric would be \$606 +\$142

Part number	H	W	Wt (lbs)	Grade 1/ COM/ Base price	Grade 2	Grade 3	Grade 4	Grade 5	Grade 6	Grade 7	Grade 8	Clear fluted polycarbonate	White fluted polycarbonate	Accent paint
<b>MS7118</b>	71"	18"	14	\$606	+\$56	+\$79	—	+\$142	+\$272	+\$399	—	—	—	+\$62



71"h Monolithic Screen

# Architecture

Frames and Screens  
1 1/2" Thick Accessory Screens

# System

## PRODUCT CODE KEY EXAMPLE

MAS5124

**MAS** Accessory Screen

**51** 51" H

**24** 24" W

- Screens may only be attached to the 3 1/2" thick tapered trim frames or 1 1/2" thick screens (brackets specified separately)
- These screens are not freestanding
- Screens include 2" dia glide with 1 1/2" height adjustability – optional gray (default) or black
- Accessory screens come fully trimmed
- Horizontal accessories including slanted sorters, paper trays and storage compartments may be hung from accessory screen
- Fabric is applied in a railroad orientation
- Tackable
- Available with round glides only

## NOTES

The following fabrics are not available on accessory screens; U5005 Sprite Snow

In order to get a total cost on products when upcharges are present take the list price of the product number and add the upcharge cost shown to the list price.

For example:  
Product MAS5124 in Grade 5 Fabric would be \$636 +\$118

Part number	H	W	Wt (lbs)	Grade 1/ COM Base price	Grade 2	Grade 3	Grade 4	Grade 5	Grade 6	Grade 7	Grade 8	Accent paint
 <b>MAS5124</b>	51"	24"	13	\$636	+\$37	+\$59	—	+\$118	+\$247	+\$375	—	+\$65
<b>MAS5130</b>	51"	30"	14	\$698	+\$51	+\$77	—	+\$144	+\$289	+\$434	—	+\$71
<b>MAS5136</b>	51"	36"	15	\$762	+\$61	+\$98	—	+\$173	+\$333	+\$494	—	+\$79
<b>MAS5142</b>	51"	42"	15	\$823	+\$77	+\$114	—	+\$206	+\$382	+\$557	—	+\$86
<b>MAS5148</b>	51"	48"	16	\$862	+\$85	+\$116	—	+\$209	+\$386	+\$562	—	+\$89
<b>MAS5154</b>	51"	54"	17	\$901	+\$89	+\$118	—	+\$210	+\$400	+\$589	—	+\$93
<b>MAS5160</b>	51"	60"	18	\$938	+\$92	+\$119	—	+\$212	+\$410	+\$606	—	+\$97

51" H Accessory Screen

 <b>MAS6424</b>	64"	24"	16	\$745	+\$52	+\$77	—	+\$145	+\$300	+\$453	—	+\$76
<b>MAS6430</b>	64"	30"	17	\$803	+\$66	+\$101	—	+\$182	+\$350	+\$518	—	+\$84
<b>MAS6436</b>	64"	36"	18	\$864	+\$85	+\$127	—	+\$215	+\$401	+\$587	—	+\$90
<b>MAS6442</b>	64"	42"	18	\$923	+\$99	+\$148	—	+\$251	+\$453	+\$653	—	+\$96
<b>MAS6448</b>	64"	48"	19	\$967	+\$103	+\$152	—	+\$256	+\$466	+\$675	—	+\$99

64" H Accessory Screen

# Architecture

Frames and Screens  
1 1/2" Thick Freestanding Screens

# System

## PRODUCT CODE KEY EXAMPLE

MSF5136

<b>MSF</b>	Freestanding Monolithic Screen
<b>51</b>	51" H
<b>36</b>	36" W

- Screens include "L" leg for freestanding support, 3/4" height adjustability
- Accessory screens come fully trimmed
- Horizontal accessories including slanted sorters, paper trays and storage compartments may be hung from accessory screen
- Max weight load of 20lbs per side
- See specifics for whiteboard maintenance and marker requirements
- Accessory screen includes tackable surface below whiteboard
- Fabric is applied in a railroad orientation
- Available with round glides only

## NOTES

The following fabrics are not available on accessory screens; U5005 Sprite Snow

In order to get a total cost on products when upcharges are present take the list price of the product number and add the upcharge cost shown to the list price.

For example:  
Product MSF5136 in Grade 5 Fabric would be \$1048 +\$221

Part number	H	W	Wt (lbs)	Grade 1/ COM Base price	Grade 2	Grade 3	Grade 4	Grade 5	Grade 6	Grade 7	Grade 8	Accent paint
<b>SASF5136</b>	51"	36"	15	\$1168	+\$35	+\$54	—	+\$146	+\$373	+\$599	—	+\$120
<b>SASF5142</b>	51"	42"	17	\$1215	+\$37	+\$57	—	+\$152	+\$386	+\$619	—	+\$125
<b>SASF5148</b>	51"	48"	19	\$1264	+\$44	+\$61	—	+\$146	+\$394	+\$630	—	+\$129



51" H Freestanding  
Whiteboard  
Accessory Screen

<b>SASF6436</b>	64"	36"	18	\$1253	+\$47	+\$53	—	+\$162	+\$399	+\$645	—	+\$128
<b>SASF6442</b>	64"	42"	20	\$1307	+\$50	+\$54	—	+\$157	+\$408	+\$658	—	+\$133
<b>SASF6448</b>	64"	48"	22	\$1366	+\$52	+\$57	—	+\$162	+\$418	+\$659	—	+\$139



64" H Freestanding  
Whiteboard  
Accessory Screen

<b>MSF5136</b>	51"	36"	23	\$1048	+\$83	+\$120	—	+\$221	+\$441	+\$660	—	+\$106
<b>MSF5142</b>	51"	42"	25	\$1077	+\$84	+\$121	—	+\$225	+\$450	+\$674	—	+\$110
<b>MSF5148</b>	51"	48"	27	\$1105	+\$84	+\$121	—	+\$227	+\$457	+\$686	—	+\$112



51" H Freestanding  
Tackable Screen

<b>MSF6436</b>	64"	36"	28	\$1142	+\$102	+\$156	—	+\$274	+\$511	+\$759	—	+\$118
<b>MSF6442</b>	64"	42"	31	\$1174	+\$102	+\$156	—	+\$274	+\$515	+\$761	—	+\$120
<b>MSF6448</b>	64"	48"	33	\$1209	+\$102	+\$156	—	+\$274	+\$521	+\$766	—	+\$124



64" H Freestanding  
Tackable Screen

# Architecture

Frames and Screens  
1 1/2" Thick Table Mounted Screens

# System

## PRODUCT CODE KEY EXAMPLE

MST3736

<b>MST</b>	Table Mounted Screen
<b>37</b>	37" H
<b>36</b>	36" W

- May be installed on Inscape Worksurfaces
- Adjustable Framed Table Mounted Screens have height adjustment for above worksurface privacy and below the worksurface modesty. It is recommended that this screen be installed with a max of 20" above the surface.
- May not be specified to attach to a 3 1/2" thick frame connector
- Fabric is applied in railed orientation
- Table mounted screen is tackable

## NOTES

The following fabrics are not available on accessory screens; U5005 Sprite Snow

In order to get a total cost on products when upcharges are present take the list price of the product number and add the upcharge cost shown to the list price.

For example:

Product MST3736 in Grade 7 Fabric would be \$607 +\$426

Part number	H	W	Wt (lbs)	Grade 1/ COM Base price	Grade 2	Grade 3	Grade 4	Grade 5	Grade 6	Grade 7	Grade 8	Accent paint
<b>MST3736</b>	37"	36"	13	\$607	+\$58	+\$90	—	+\$156	+\$289	+\$426	—	+\$63
<b>MST3742</b>	37"	42"	15	\$633	+\$59	+\$91	—	+\$156	+\$293	+\$430	—	+\$65
<b>MST3748</b>	37"	48"	16	\$658	+\$64	+\$92	—	+\$157	+\$296	+\$435	—	+\$67
<b>MST3754</b>	37"	54"	18	\$681	+\$66	+\$98	—	+\$160	+\$305	+\$444	—	+\$70
<b>MST3760</b>	37"	60"	19	\$705	+\$72	+\$103	—	+\$160	+\$312	+\$455	—	+\$72

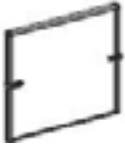

37" H Adjustable  
Framed Table  
Mounted Screen  
Tackable

**PRODUCT CODE  
KEY EXAMPLE**



**INSD5136LH-3F**

<b>IN</b>	Inscape System
<b>SD</b>	Sliding Door
<b>51</b>	51" H
<b>36</b>	36" W opening
<b>LH</b>	Left-handed
<b>3F</b>	3.5" thick frame

- Sliding doors consist of polycarbonate material which has naturally occurring variances in the material
- Sliding door includes complete door assembly (trim, polycarbonate material, two door pulls, two 2.5" adjustable casters and top/bottom connector brackets to attach to the panel – optional lock available)
- Black casters
- Locking option available at an upcharge of \$142 per door
- When locking door is specified the crossrail at the 37" H location must be accessible between two tiles for the locking mechanism to function
- See Application Guide for tile configuration to accommodate locking mechanism

**NOTES**

- Be sure to specify correct sliding door configuration based on the frame it is being installed on
- Sliding doors are specific to frame thickness being installed
- Sliding doors are handed and are based on the direction the door slides to open from front view
- Specify the 36" W sliding door on panel or combination of panels 42" W or greater
- Specify the 42" W sliding door on panel or combination of panels 48" W or greater

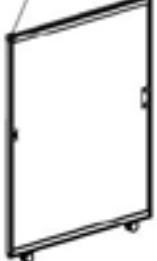
		Part number	H	W	Clear fluted / White fluted polycarbonate	Accent paint
	51" H Sliding Door 3.5" Thick Frame	<b>INSD5136LH-3F</b>	51"	49"	\$1284	+\$131
		<b>INSD5142LH-3F</b>	51"	55"	\$1414	+\$143
		<b>INSD5136RH-3F</b>	51"	49"	\$1284	+\$131
		<b>INSD5142RH-3F</b>	51"	55"	\$1414	+\$143
	64" H Sliding Door 3.5" Thick Frame	<b>INSD6436LH-3F</b>	64"	49"	\$1461	+\$147
		<b>INSD6442LH-3F</b>	64"	55"	\$1669	+\$170
		<b>INSD6436RH-3F</b>	64"	49"	\$1461	+\$147
		<b>INSD6442RH-3F</b>	64"	55"	\$1669	+\$170
	51" H Sliding Door 2.75" Thick Frame	<b>INSD5136LH-2F</b>	51"	49"	\$1290	+\$131
		<b>INSD5142LH-2F</b>	51"	55"	\$1422	+\$143
		<b>INSD5136RH-2F</b>	51"	49"	\$1290	+\$131
		<b>INSD5142RH-2F</b>	51"	55"	\$1422	+\$143
	64" H Sliding Door 2.75" Thick Frame	<b>INSD6436LH-2F</b>	64"	49"	\$1476	+\$148
		<b>INSD6442LH-2F</b>	64"	55"	\$1615	+\$165
		<b>INSD6436RH-2F</b>	64"	49"	\$1476	+\$148
		<b>INSD6442RH-2F</b>	64"	55"	\$1615	+\$165



Inscape System 2 1/2" and 3 1/2" frames may be connected in a variety of ways including on and off-module, straight inline, two-way, three-way and four-way configurations. Frames of the same height or frames of differing heights may be connected together. All top caps, end of line trim, and connectors must be specified independently from the frame. To facilitate specification, connectors are available in same height kits which include all connector brackets, plugs, plates, trim clips and finished trim. 90° and 120° connections are achievable with both thickness of panel. When creating frames of varying heights, kits need to be built up. A combination of same height "L", "T" or "X" connections along with Stack-on Connectors and vertical trim will create a finished connection. Begin by connecting all common heights and working up.

A handful of universal connectors create all Inscape System panel configurations for the 2 3/4" and 3 1/2" frames. The 1 1/2" screen has its own set of connectors which are specific for this thinner screen. A 3/16" Allen Key is all that is required to fasten connector bolts. Trim is constructed of aluminum.

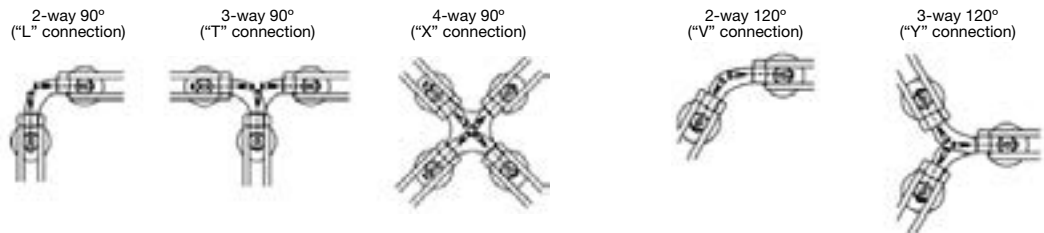

### INLINE CONNECTORS

Inline connectors are specified to join two frames together which are in alignment. These connectors are specified based on the height of the panels.

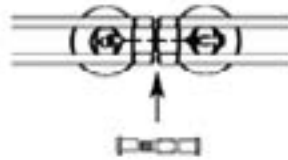

### OFF MODULE CONNECTIONS

Off module connections are specific for frame thickness as well as location where the panel will be mounted to the spine. The off-module panel may be positioned at the end of the panel or in the middle of the panel, with the corresponding bracket. Cannot be used with monolithic tiles on spine. See Inscape System Application Guide.

### CONNECTION KITS

Connection kits come in a variety of heights and configurations, within 90° and 120° connections and are based on the panel orientation. Within the connection kit, finished trim, panel connector bracket and short bolts are included depending on the configuration specified. Connector kits are panel thickness specific due to the thickness of the finished trim. The brackets and bolts within are part of the universal kit of parts and may be used for either thickness of panel. Special connectors have been structured to connect 3 1/2" and 2 3/4" in the same height connections. These are also kitted and include connecting brackets and flat trim profile only. When specifying connections on module and of varying height (when only one thickness of panel is specified) the connection will need to be "built". This can be done by specifying the lowest same height connection and building stack trims to complete the top connection portion. There are a few pre-built connector kits for varying height configurations. Connector kits for Stack-on frames allow for construction of multi height connections.



## WALL CONNECTORS

Wall connectors are specified based on the height of the panel attaching to the wall. All hardware is included in order to attach the panel to the wall. This connector is not visible, and sets frame off wall slightly.

## END TRIM

End trim is kit structured to include all brackets, bolts and finished trim; Tapered or Flat. Trim profiles are available in two profile options for the 3 1/2" thick frame; Tapered and Flat, and Flat for the 2 3/4" thick frames. When connecting these two thicknesses of frame at a connection, only the Flat trim profile may be specified. Vertical trim heights are available to match all frame heights as well as in four modular heights of 6.75", 13.5", 20.25" and 27". Trim is manufactured from aluminum and always aligns straight and true when frames are connected. All painted aluminum vertical trim and top trim are easily removed to facilitate lay in of cables.

## HI-LO TRIM

Hi-Lo trim is designed to be situated at the end of line condition of a higher frame, where the top cap of a lower height frame meets the vertical trim. The profile of the top cap has been scribed from the Hi-Lo trim.

## STACK-ON END TRIM

Stack-on end trim is used when a higher frame requires vertical end trim at a connection. Hi-Lo trim may be used in this application for Flat profile trim because there is no 'scribing' that is required for this profile.

## TOP CAPS

Top caps are specified separately. Top caps include clips to mount on a frame or combination of two frames as outlined in the Inscape System Application Guide. Painted aluminum profile is available for both thickness of frame. Painted aluminum tapered is available for 3 1/2" thick frame. When spanning two frames when 60" or less in width, two additional Jesters are required to be specified.

## 1.5" THICK SCREEN CONNECTORS

1 1/2" Thick screen connectors allow for two-way ("L"), three-way ("T"), and four way ("X") connections. Each condition, excluding the inline, includes a 1 1/2" square extruded aluminum connector post and the required number of post connector clips. The inline condition only requires inline connector clips which mount directly into the frames of the adjoining screens to complete the connection. The connector post may be finished in any of the standard Inscape System paint finishes.

Post connector clips are a standard black finish. Universal 1 1/2" connector kits include all required connector hardware and trim necessary to make 'L', 'T' and 'X' connections. Specify one height specific universal connector kit to accommodate any of the three corner conditions. Inline connector kits come complete with the required amount of connector clips.

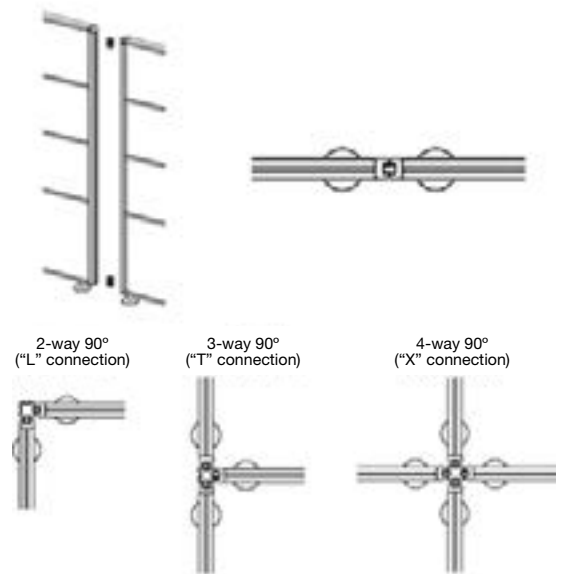

## CRENZEA STORAGE BENCHING COMPLIMENT END TRIM

Credenza storage benching compliment end trim is specified where the low height panel is situated between two Credenza Storage cases and end trim is to be specified. This trim is available with cutout or without depending if a power feed needs to enter at that location. The trim can be painted the same color as the cases. Two end trim types have been designed; one to correspond with a lateral top and one for a cushion top. These are specific to the situation in which they are being installed. This is used for 3 1/2" thick application only. See Inscape System Application Guide.

- Connectors and trim are specified independently of frames
- All mounting hardware and finish trim is included for corresponding frame thickness

**TOP CAP**

- Top caps may span two frames. See Inscape System Application Guide for details
- Top caps up to 60"W requires two additional Jesters to be specified if spanning multiple frames (ie a 60"W top trim installed on 2-30" frames)

**END TRIM**

- Stack-On End Trim is used when stack frames are specified and full height trim is not specified (whenever possible order full height trims when adding a stack on frame)



- Hi-Lo End trim is used where two frames in alignment are of different heights. The Hi-Lo End trim mounts to the side of the higher panel to finish it off
- Flat Hi-Lo End Trim may also be used in a stack on solution. The flat bottom profile allows for this trim to be used in multiple conditions

**NOTES**

In order to get a total cost on products when upcharges are present take the list price of the product number and add the upcharge cost shown to the list price.

For example:

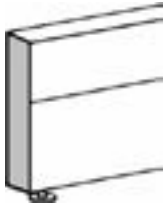
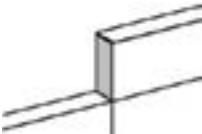
Product INTC18-3F Tapered in an accent paint would be \$44 +\$8



	Part number	H	Thickness	Tapered	Flat	Accent paint
 <p>Top Cap</p>	<b>INTC18-3F</b>	—	3 1/2"	\$44	\$44	+\$8
	<b>INTC24-3F</b>	—	3 1/2"	\$51	\$51	+\$9
	<b>INTC30-3F</b>	—	3 1/2"	\$60	\$60	+\$9
	<b>INTC36-3F</b>	—	3 1/2"	\$65	\$65	+\$10
	<b>INTC42-3F</b>	—	3 1/2"	\$71	\$71	+\$10
	<b>INTC48-3F</b>	—	3 1/2"	\$73	\$73	+\$11
	<b>INTC54-3F</b>	—	3 1/2"	\$91	\$91	+\$12
	<b>INTC60-3F</b>	—	3 1/2"	\$97	\$97	+\$13
	<b>INTC66-3F</b>	—	3 1/2"	—	\$112	+\$15
	<b>INTC72-3F</b>	—	3 1/2"	—	\$118	+\$15
	<b>INTC78-3F</b>	—	3 1/2"	—	\$126	+\$16
	<b>INTC84-3F</b>	—	3 1/2"	—	\$137	+\$17
	<b>INTC90-3F</b>	—	3 1/2"	—	\$141	+\$17
<b>INTC96-3F</b>	—	3 1/2"	—	\$144	+\$18	
 <p>End-of-Line Trim</p>	<b>INET24-3F</b>	24"	3 1/2"	\$34	\$34	+\$7
	<b>INET29-3F</b>	29"	3 1/2"	\$46	\$46	+\$8
	<b>INET37-3F</b>	37"	3 1/2"	\$54	\$54	+\$9
	<b>INET44-3F</b>	44"	3 1/2"	\$60	\$60	+\$9
	<b>INET51-3F</b>	51"	3 1/2"	\$67	\$67	+\$10
	<b>INET57-3F</b>	57"	3 1/2"	\$79	\$79	+\$11
	<b>INET64-3F</b>	64"	3 1/2"	\$88	\$88	+\$12
	<b>INET78-3F</b>	78"	3 1/2"	\$110	\$110	+\$15
	<b>INET91-3F</b>	91"	3 1/2"	\$134	\$134	+\$17
 <p>Hi-Lo End Trim</p>	<b>INETHL6.75-3F</b>	6.75"	3 1/2"	\$27	\$27	+\$7
	<b>INETHL13.5-3F</b>	13.5"	3 1/2"	\$43	\$43	+\$8
	<b>INETHL20.25-3F</b>	20.25"	3 1/2"	\$51	\$51	+\$9
	<b>INETHL27-3F</b>	27"	3 1/2"	\$79	\$79	+\$11
 <p>Stack-On Trim</p>	<b>INET6.75-3F</b>	6.75"	3 1/2"	\$25	\$25	+\$6
	<b>INET13.5-3F</b>	13.5"	3 1/2"	\$39	\$39	+\$8
	<b>INET20.25-3F</b>	20.25"	3 1/2"	\$47	\$47	+\$8
	<b>INET27-3F</b>	27"	3 1/2"	\$73	\$73	+\$11

# Architecture

Connectors and Trim  
3 1/2" Thick 90° Connector Kits

# System

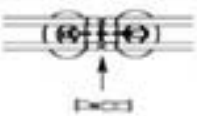
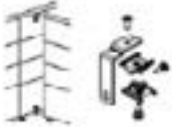
- Inline connectors are required to be specified when frames are connected inline
- Off-module bracket "MP" – when an off-module frame is to be mounted in the middle of the frame (frame thickness specific)
- Off-module bracket "EP" – when an off-module frame is to be mounted at either end of the frame. See application guide
- For back to back off-module applications at either end of a panel, 2x "EP" off-module bracket codes are required
- Two sided off-module brackets are specified when frames are of- module on both sides of the "spine" frame
- Off-module bracket suffix (3F) is based on the frame thickness
- Off-module brackets cannot be used where monolithic tiles are present on spine. The lower bracket requires segmentation in tiles to attach to crossrail
- Specify wall start connector based on the height of the frame (64" to be cut on site when used with 57" high frame)

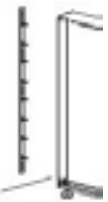
	Part number	H	List price
	Inline Connector Kit	<b>INLINE-1</b>	All Stack on Frame" \$0
		<b>INLINE-2</b>	24"h - 51"h Frame" \$0
		<b>INLINE-3</b>	57"h - 64"h Frame" \$0
		<b>INLINE-4</b>	71"h - 91"h Frame" \$0
	Off-Module Bracket	<b>INCPOFM-MP-3F</b>	— \$93
		<b>INCPOFM-EP</b>	— \$93
	Off-Module Bracket for two sided application	<b>INCPOFMX-3F</b>	— \$133
	Wall Start Connector	<b>INCPW2</b>	24 & 29" \$208
		<b>INCPW3</b>	37" \$215
		<b>INCPW4</b>	44" \$240
		<b>INCPW5</b>	51" \$263
		<b>INCPW6</b>	57 & 64" \$283
		<b>INCPW7</b>	78" \$288
		<b>INCPW9</b>	91" \$292

# Architecture

## Connectors and Trim

3 1/2" Thick 90° Same Height Connector Kits

# System

- Connector kits include connector brackets, bolts, nuts and finished trim to create connection
- Specify code based on height of frames within connection
- The connection kits may be used in conjunction with Stack-on Connectors and vertical trim to create multi-height connections





### NOTES

Be sure to specify correct thickness of connector kit based on the frame thickness

In order to get a total cost on products when upcharges are present take the list price of the product number and add the upcharge cost shown to the list price.

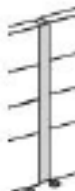
For example:

Product INCPL3300-3F in an accent paint would be \$101 +\$13

	Part number	H	Thickness	Tapered	Flat	Accent paint	
	Full Height Straight Filler	<b>INCPSLW-3F</b>	24"	3 1/2"	\$89	\$89	+\$12
		<b>INCPS2020-3F</b>	29"	3 1/2"	\$106	\$106	+\$13
		<b>INCPS3030-3F</b>	37"	3 1/2"	\$114	\$114	+\$15
		<b>INCPS4040-3F</b>	44"	3 1/2"	\$135	\$135	+\$17
		<b>INCPS5050-3F</b>	51"	3 1/2"	\$143	\$143	+\$18
		<b>INCPS57-5050-3F</b>	57"	3 1/2"	\$167	\$167	+\$20
		<b>INCPS6060-3F</b>	64"	3 1/2"	\$197	\$197	+\$22
		<b>INCPS7070-3F</b>	78"	3 1/2"	\$245	\$245	+\$26
		<b>INCPS9090-3F</b>	91"	3 1/2"	\$292	\$292	+\$31
	Full Height "L" Connector	<b>INCPLLW-3F</b>	24"	3 1/2"	\$72	\$72	+\$11
		<b>INCPL2200-3F</b>	29"	3 1/2"	\$93	\$93	+\$12
		<b>INCPL3300-3F</b>	37"	3 1/2"	\$101	\$101	+\$13
		<b>INCPL4400-3F</b>	44"	3 1/2"	\$107	\$107	+\$15
		<b>INCPL5500-3F</b>	51"	3 1/2"	\$119	\$119	+\$15
		<b>INCPL57-5500-3F</b>	57"	3 1/2"	\$131	\$131	+\$17
		<b>INCPL6600-3F</b>	64"	3 1/2"	\$154	\$154	+\$19
		<b>INCPL7700-3F</b>	78"	3 1/2"	\$180	\$180	+\$21
		<b>INCPL9900-3F</b>	91"	3 1/2"	\$215	\$215	+\$24
	Full Height "T" Connector	<b>INCPTLW-3F</b>	24"	3 1/2"	\$93	\$93	+\$12
		<b>INCPT2220-3F</b>	29"	3 1/2"	\$138	\$138	+\$17
		<b>INCPT3330-3F</b>	37"	3 1/2"	\$147	\$147	+\$18
		<b>INCPT4440-3F</b>	44"	3 1/2"	\$159	\$159	+\$19
		<b>INCPT5550-3F</b>	51"	3 1/2"	\$165	\$165	+\$19
		<b>INCPT57-5550-3F</b>	57"	3 1/2"	\$197	\$197	+\$22
		<b>INCPT6660-3F</b>	64"	3 1/2"	\$218	\$218	+\$24
		<b>INCPT7770-3F</b>	78"	3 1/2"	\$265	\$265	+\$29
		<b>INCPT9990-3F</b>	91"	3 1/2"	\$305	\$305	+\$33
	"X" Connector	<b>INCPXLW-3F</b>	24"	3 1/2"	\$131	\$131	+\$17
		<b>INCPX2222-3F</b>	29"	3 1/2"	\$178	\$178	+\$21
		<b>INCPX3333-3F</b>	37"	3 1/2"	\$191	\$191	+\$22
		<b>INCPX4444-3F</b>	44"	3 1/2"	\$198	\$198	+\$22
		<b>INCPX5555-3F</b>	51"	3 1/2"	\$204	\$204	+\$23
		<b>INCPX57-5555-3F</b>	57"	3 1/2"	\$219	\$219	+\$24
		<b>INCPX6666-3F</b>	64"	3 1/2"	\$235	\$235	+\$25
		<b>INCPX7777-3F</b>	78"	3 1/2"	\$258	\$258	+\$27
		<b>INCPX9999-3F</b>	91"	3 1/2"	\$288	\$288	+\$31

# Architecture

## Connectors and Trim

### 3 1/2" Thick 90° Stack-on Connector Kits

# System

- Available in heights matching incremental change of frame heights; 6.75", 13.5", 20.25" and 27" H
- Specify based on configuration requirement
- May be used in conjunction with same height kits and end trim to create multi height configurations



### NOTES

Be sure to specify correct thickness of connector kit based on the frame thickness

In order to get a total cost on products when upcharges are present take the list price of the product number and add the upcharge cost shown to the list price.

For example:

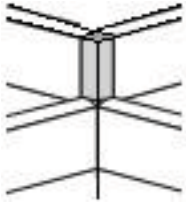
Product INCPT13.5-3F in an accent paint would be \$46 +\$8

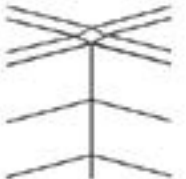
	Part number	H	Thickness	Tapered	Flat	Accent paint	
	Straight Filler Connection	<b>INCPS6.75-3F</b>	6.75"	3 1/2"	\$32	\$32	+\$7
		<b>INCPS13.5-3F</b>	13.5"	3 1/2"	\$57	\$57	+\$9
		<b>INCPS20.25-3F</b>	20.25"	3 1/2"	\$91	\$91	+\$12
		<b>INCPS27-3F</b>	27"	3 1/2"	\$102	\$102	+\$13
	"L" Connection	<b>INCPL6.75-3F</b>	6.75"	3 1/2"	\$29	\$29	+\$7
		<b>INCPL13.5-3F</b>	13.5"	3 1/2"	\$46	\$46	+\$8
		<b>INCPL20.25-3F</b>	20.25"	3 1/2"	\$70	\$70	+\$10
		<b>INCPL27-3F</b>	27"	3 1/2"	\$91	\$91	+\$12
	"T" Connection	<b>INCPT6.75-3F</b>	6.75"	3 1/2"	\$29	\$29	+\$7
		<b>INCPT13.5-3F</b>	13.5"	3 1/2"	\$46	\$46	+\$8
		<b>INCPT20.25-3F</b>	20.25"	3 1/2"	\$71	\$71	+\$10
		<b>INCPT27-3F</b>	27"	3 1/2"	\$91	\$91	+\$12
	"X" Connection	<b>INCPX6.75-3F</b>	6.75"	3 1/2"	\$20	\$20	+\$6
		<b>INCPX13.5-3F</b>	13.5"	3 1/2"	\$25	\$25	+\$6
		<b>INCPX20.25-3F</b>	20.25"	3 1/2"	\$29	\$29	+\$7
		<b>INCPX27-3F</b>	27"	3 1/2"	\$32	\$32	+\$7

# Architecture





Connectors and Trim  
3 1/2" Thick 120° Connector Kits

# System

- Connector kits include connector brackets, bolts, nuts and finished trim to create connection
- Specify code based on height of frames within connection

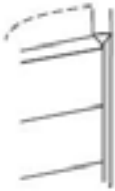
## NOTES

Be sure to specify correct thickness of connector kit based on the frame thickness

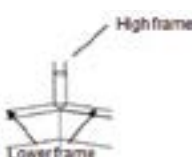
	Part number	H	Thickness	Tapered	Flat	Accent paint	
	Full Height "V" Connection	<b>INCPV220-3F</b>	29"	3 1/2"	\$169	\$169	+\$20
		<b>INCPV330-3F</b>	37"	3 1/2"	\$178	\$178	+\$21
		<b>INCPV440-3F</b>	44"	3 1/2"	\$188	\$188	+\$21
		<b>INCPV550-3F</b>	51"	3 1/2"	\$198	\$198	+\$22
		<b>INCPV57-550-3F</b>	57"	3 1/2"	\$210	\$210	+\$23
		<b>INCPV660-3F</b>	64"	3 1/2"	\$229	\$229	+\$25
	Full Height "Y" Connection	<b>INCPY222-3F</b>	29"	3 1/2"	\$318	\$318	+\$34
		<b>INCPY333-3F</b>	37"	3 1/2"	\$328	\$328	+\$34
		<b>INCPY444-3F</b>	44"	3 1/2"	\$343	\$343	+\$36
		<b>INCPY555-3F</b>	51"	3 1/2"	\$368	\$368	+\$39
		<b>INCPY57-555-3F</b>	57"	3 1/2"	\$443	\$443	+\$47
		<b>INCPY666-3F</b>	64"	3 1/2"	\$511	\$511	+\$53
	Stack-On "V" Connection	<b>INCPV6.75-3F</b>	6.75"	3 1/2"	\$178	\$178	+\$21
		<b>INCPV13.5-3F</b>	13.5"	3 1/2"	\$188	\$188	+\$21
		<b>INCPV20.25-3F</b>	20.25"	3 1/2"	\$198	\$198	+\$22
		<b>INCPV27-3F</b>	27"	3 1/2"	\$210	\$210	+\$23
	Stack-On "Y" Connection	<b>INCPY6.75-3F</b>	6.75"	3 1/2"	\$18	\$18	+\$6
		<b>INCPY13.5-3F</b>	13.5"	3 1/2"	\$25	\$25	+\$6
		<b>INCPY20.25-3F</b>	20.25"	3 1/2"	\$29	\$29	+\$7
		<b>INCPY27-3F</b>	27"	3 1/2"	\$32	\$32	+\$7
	120° Stack-On End Trim, Multi Height	<b>INST6.75Y-3F</b>	6.75"	3 1/2"	\$178	\$178	+\$21
		<b>INST13.5Y-3F</b>	13.5"	3 1/2"	\$188	\$188	+\$21
		<b>INST20.25Y-3F</b>	20.25"	3 1/2"	\$198	\$198	+\$22
		<b>INST27Y-3F</b>	27"	3 1/2"	\$210	\$210	+\$23

- Connectors and trim are specified independently of frames
- All mounting hardware and finish trim is included for corresponding frame thickness
- 2 3/4" thickness is not available in the tapered profile

**TOP CAP**

- Top caps may span two frames. See Inscape System Application Guide for details
- Top caps up to 60"w requires two additional Jesters to be specified if spanning multiple frames (ie a 60"W top trim installed on 2-30" frames).

**END TRIM**



- Hi-Lo End trim is used where two frames in alignment are of different heights. The Hi-Lo End trim mounts to the side of the higher panel to finish it off
- Flat Hi-Lo End Trim may also be used in a stack on solution. The flat bottom profile allows for this trim to be used in multiple conditions

**NOTES**

In order to get a total cost on products when upcharges are present take the list price of the product number and add the upcharge cost shown to the list price.

For example:

Product INTC18-2F in an accent paint would be \$44 +\$8

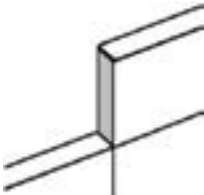
		Part number	H	Thickness	Tapered	Flat	Accent paint
	Top Cap	<b>INTC18-2F</b>	—	2 3/4"	—	\$44	+\$8
		<b>INTC24-2F</b>	—	2 3/4"	—	\$51	+\$9
		<b>INTC30-2F</b>	—	2 3/4"	—	\$60	+\$9
		<b>INTC36-2F</b>	—	2 3/4"	—	\$65	+\$10
		<b>INTC42-2F</b>	—	2 3/4"	—	\$71	+\$10
		<b>INTC48-2F</b>	—	2 3/4"	—	\$73	+\$11
		<b>INTC54-2F</b>	—	2 3/4"	—	\$91	+\$12
		<b>INTC60-2F</b>	—	2 3/4"	—	\$97	+\$13
		<b>INTC66-2F</b>	—	2 3/4"	—	\$112	+\$15
		<b>INTC72-2F</b>	—	2 3/4"	—	\$118	+\$15
		<b>INTC78-2F</b>	—	2 3/4"	—	\$126	+\$16
		<b>INTC84-2F</b>	—	2 3/4"	—	\$137	+\$17
		<b>INTC90-2F</b>	—	2 3/4"	—	\$141	+\$17
		<b>INTC96-2F</b>	—	2 3/4"	—	\$144	+\$18
	End-of-Line Trim	<b>INET24-2F</b>	24"	2 3/4"	—	\$34	+\$7
		<b>INET29-2F</b>	29"	2 3/4"	—	\$46	+\$8
		<b>INET37-2F</b>	37"	2 3/4"	—	\$54	+\$9
		<b>INET44-2F</b>	44"	2 3/4"	—	\$60	+\$9
		<b>INET51-2F</b>	51"	2 3/4"	—	\$67	+\$10
		<b>INET57-2F</b>	57"	2 3/4"	—	\$79	+\$11
		<b>INET64-2F</b>	64"	2 3/4"	—	\$88	+\$12
		<b>INET78-2F</b>	78"	2 3/4"	—	\$110	+\$15
		<b>INET91-2F</b>	91"	2 3/4"	—	\$134	+\$17
	Hi-Lo End Trim	<b>INETHL6.75-2F</b>	6.75"	2 3/4"	—	\$27	+\$7
		<b>INETHL13.5-2F</b>	13.5"	2 3/4"	—	\$43	+\$8
		<b>INETHL20.25-2F</b>	20.25"	2 3/4"	—	\$51	+\$9
		<b>INETHL27-2F</b>	27"	2 3/4"	—	\$79	+\$11





# Architecture

Connectors and Trim  
2 3/4" Thick 90° Connector Kits

# System

- Inline connectors are required to be specified when frames are connected inline
- Off-module bracket "MP" – when an off-module frame is to be mounted in the middle of the frame thickness specific)
- Off-module bracket "EP" – when an off-module frame is to be mounted at either end of the frame. See application guide
- For back to back off-module applications at either end of a panel, 2x "EP" off-module bracket codes are required
- Two sided off-module brackets are specified when frames are of- module on both sides of the "spine" frame
- Off-module bracket suffix (2F) is based on the frame thickness
- Off-module brackets cannot be used where monolithic tiles are present on spine. The lower bracket requires segmentation in tiles to attach to crossrail
- Specify wall start connector based on the height of the frame (64" to be cut on site when used with 57" H frame)

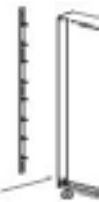
	Part number	H	List price
	Inline Connector Kit	<b>INLINE-1</b>	All Stack on Frame" \$0
		<b>INLINE-2</b>	24"h - 51"h Frame" \$0
		<b>INLINE-3</b>	57"h - 64"h Frame" \$0
		<b>INLINE-4</b>	71"h - 91"h Frame" \$0
	Off-Module Bracket	<b>INCPFM-MP-2F</b>	— \$94
		<b>INCPFM-EP</b>	— \$93
	Off-Module Bracket for two sided application	<b>INCPFMX-2F</b>	— \$133
	Wall Start Connector	<b>INCPW2</b>	24 & 29" \$208
		<b>INCPW3</b>	37" \$215
		<b>INCPW4</b>	44" \$240
		<b>INCPW5</b>	51" \$263
		<b>INCPW6</b>	57 & 64" \$283
		<b>INCPW7</b>	78" \$288
		<b>INCPW9</b>	91" \$292

# Architecture

## Connectors and Trim

2 3/4" Thick 90° Same Height Connector Kits

# System

- Configurations include all hardware and finished trim to create the configuration
- Specify code based on height of frames within connection
- The connection kits may be used in conjunction with Stack-on Connectors and vertical trim to create multi-height connections



### NOTES

Be sure to specify correct thickness of connector kit based on the frame thickness

In order to get a total cost on products when upcharges are present take the list price of the product number and add the upcharge cost shown to the list price.

For example:

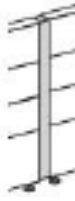
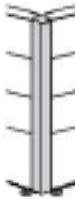
Product INCPL3300-2F in an accent paint would be \$145 +\$18

		Part number	H	Thickness	Tapered	Flat	Accent paint
	Full Height Straight Filler Connector	<b>INCPSLW-2F</b>	24"	2 3/4"	—	\$89	+\$12
		<b>INCPS2020-2F</b>	29"	2 3/4"	—	\$106	+\$13
		<b>INCPS3030-2F</b>	37"	2 3/4"	—	\$114	+\$15
		<b>INCPS4040-2F</b>	44"	2 3/4"	—	\$135	+\$17
		<b>INCPS5050-2F</b>	51"	2 3/4"	—	\$143	+\$18
		<b>INCPS57-5050-2F</b>	57"	2 3/4"	—	\$167	+\$20
		<b>INCPS6060-2F</b>	64"	2 3/4"	—	\$197	+\$22
	Full Height "L" Connector	<b>INCPLLW-2F</b>	24"	2 3/4"	—	\$129	+\$16
		<b>INCPL2200-2F</b>	29"	2 3/4"	—	\$134	+\$17
		<b>INCPL3300-2F</b>	37"	2 3/4"	—	\$145	+\$18
		<b>INCPL4400-2F</b>	44"	2 3/4"	—	\$157	+\$19
		<b>INCPL5500-2F</b>	51"	2 3/4"	—	\$165	+\$19
		<b>INCPL57-5500-2F</b>	57"	2 3/4"	—	\$242	+\$26
		<b>INCPL6600-2F</b>	64"	2 3/4"	—	\$251	+\$27
	Full Height "T" Connector	<b>INCPTLW-2F</b>	24"	2 3/4"	—	\$93	+\$12
		<b>INCPT2220-2F</b>	29"	2 3/4"	—	\$138	+\$17
		<b>INCPT3330-2F</b>	37"	2 3/4"	—	\$147	+\$18
		<b>INCPT4440-2F</b>	44"	2 3/4"	—	\$159	+\$19
		<b>INCPT5550-2F</b>	51"	2 3/4"	—	\$165	+\$19
		<b>INCPT57-5550-2F</b>	57"	2 3/4"	—	\$197	+\$22
		<b>INCPT6660-2F</b>	64"	2 3/4"	—	\$218	+\$24
	"X" Connector	<b>INCPXLW-2F</b>	24"	2 3/4"	—	\$131	+\$17
		<b>INCPX2222-2F</b>	29"	2 3/4"	—	\$178	+\$21
		<b>INCPX3333-2F</b>	37"	2 3/4"	—	\$191	+\$22
		<b>INCPX4444-2F</b>	44"	2 3/4"	—	\$198	+\$22
		<b>INCPX5555-2F</b>	51"	2 3/4"	—	\$204	+\$23
		<b>INCPX57-5555-2F</b>	57"	2 3/4"	—	\$219	+\$24
		<b>INCPX6666-2F</b>	64"	2 3/4"	—	\$235	+\$25

# Architecture

## Connectors and Trim

### 2 3/4" Thick 90° Stack-on Connector Kits

# System

- Available in heights matching incremental change of frame heights; 6.75", 13.5", 20.25" and 27" H
- Specify based on configuration requirement
- May be used in conjunction with same height kits and end trim to create multi height configurations

#### NOTES

Be sure to specify correct thickness of connector kit based on the frame thickness

In order to get a total cost on products when upcharges are present take the list price of the product number and add the upcharge cost shown to the list price.

For example:

Product INCPL13.5-2F in an accent paint would be \$67 +\$10

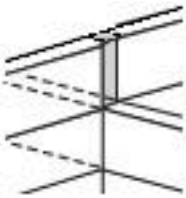
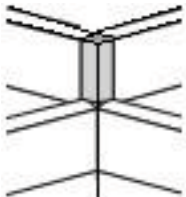
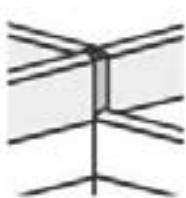
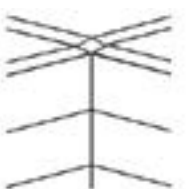
	Part number	H	Thickness	Tapered	Flat	Accent paint
	Straight Filler Connection					
	<b>INCPS6.75-2F</b>	6.75"	2 3/4"	—	\$32	+\$7
	<b>INCPS13.5-2F</b>	13.5"	2 3/4"	—	\$57	+\$9
	<b>INCPS20.25-2F</b>	20.25"	2 3/4"	—	\$91	+\$12
	<b>INCPS27-2F</b>	27"	2 3/4"	—	\$102	+\$13
	"L" Connection					
	<b>INCPL6.75-2F</b>	6.75"	2 3/4"	—	\$39	+\$8
	<b>INCPL13.5-2F</b>	13.5"	2 3/4"	—	\$67	+\$10
	<b>INCPL20.25-2F</b>	20.25"	2 3/4"	—	\$99	+\$13
	<b>INCPL27-2F</b>	27"	2 3/4"	—	\$129	+\$16
	"T" Connection					
	<b>INCPT6.75-2F</b>	6.75"	2 3/4"	—	\$29	+\$7
	<b>INCPT13.5-2F</b>	13.5"	2 3/4"	—	\$46	+\$8
	<b>INCPT20.25-2F</b>	20.25"	2 3/4"	—	\$71	+\$10
	<b>INCPT27-2F</b>	27"	2 3/4"	—	\$91	+\$12
	"X" Connection					
	<b>INCPX6.75-2F</b>	6.75"	2 3/4"	—	\$20	+\$6
	<b>INCPX13.5-2F</b>	13.5"	2 3/4"	—	\$25	+\$6
	<b>INCPX20.25-2F</b>	20.25"	2 3/4"	—	\$29	+\$7
	<b>INCPX27-2F</b>	27"	2 3/4"	—	\$32	+\$7

# Architecture



Connectors and Trim  
2 3/4" Thick 120° Connector Kits

# System

- Connector kits include connector brackets, bolts, nuts and finished trim to create connection
- Specify code based on height of frames within connection

## NOTES

Be sure to specify correct thickness of connector kit based on the frame thickness

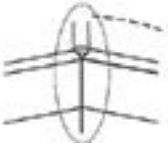
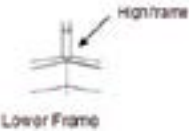

	Part number	H	Thickness	Flat/ base price	Accent paint	
	Full Height "V" Connector	<b>INCPV220-2F</b>	29"	2 3/4"	\$169	+\$20
		<b>INCPV330-2F</b>	37"	2 3/4"	\$178	+\$21
		<b>INCPV440-2F</b>	44"	2 3/4"	\$188	+\$21
		<b>INCPV550-2F</b>	51"	2 3/4"	\$198	+\$22
		<b>INCPV57-550-2F</b>	57"	2 3/4"	\$210	+\$23
		<b>INCPV660-2F</b>	64"	2 3/4"	\$229	+\$25
	Full Height "Y" Connector	<b>INCPY222-2F</b>	29"	2 3/4"	\$318	+\$34
		<b>INCPY333-2F</b>	37"	2 3/4"	\$328	+\$34
		<b>INCPY444-2F</b>	44"	2 3/4"	\$343	+\$36
		<b>INCPY555-2F</b>	51"	2 3/4"	\$368	+\$39
		<b>INCPY57-555-2F</b>	57"	2 3/4"	\$443	+\$47
		<b>INCPY666-2F</b>	64"	2 3/4"	\$511	+\$53
	Stack-On "V" Connector	<b>INCPV6.75-2F</b>	6.75"	2 3/4"	\$180	+\$21
		<b>INCPV13.5-2F</b>	13.5"	2 3/4"	\$189	+\$22
		<b>INCPV20.25-2F</b>	20.25"	2 3/4"	\$198	+\$22
		<b>INCPV27-2F</b>	27"	2 3/4"	\$210	+\$23
		<b>INCPV10-2F</b>	10.125"	2 3/4"	\$185	+\$21
	Stack-On "Y" Connector	<b>INCPY6.75-2F</b>	6.75"	2 3/4"	\$20	+\$6
		<b>INCPY13.5-2F</b>	13.5"	2 3/4"	\$25	+\$6
		<b>INCPY20.25-2F</b>	20.25"	2 3/4"	\$29	+\$7
		<b>INCPY27-2F</b>	27"	2 3/4"	\$32	+\$7
		<b>INCPY10-2F</b>	10.125"	2 3/4"	\$22	+\$6
	120° Stack-On End Trim, Multi Height	<b>INST6.75Y-2F</b>	6.75"	2 3/4"	\$180	+\$21
		<b>INST13.5Y-2F</b>	13.5"	2 3/4"	\$189	+\$22
		<b>INST20.25Y-2F</b>	20.25"	2 3/4"	\$198	+\$22
		<b>INST27Y-2F</b>	27"	2 3/4"	\$210	+\$23
		<b>INST10Y-2F</b>	10.125"	2 3/4"	\$185	+\$21

# Architecture

Connectors and Trim  
1 1/2" Thick Screen Connectors

# System

- Inline Connectors differ from those of the Inscape System panel
- Universal connectors are self finished and solve all L, T and X connections
- Specify universal connector code based on height of the frames within connection

	Part number	H	Neutral paint/ base price	Accent paint
	<b>FSSC</b>	3 <sup>3</sup> / <sub>4</sub> "/51"	\$29	—
	<b>FSSC64</b>	64"	\$42	—
	<b>FSUC37</b>	37"	\$121	+\$16
	<b>FSUC44</b>	44"	\$130	+\$16
	<b>FSUC51</b>	51"	\$137	+\$17
	<b>FSUC64</b>	64"	\$185	+\$21
	<b>CFW</b>	—	\$48	—

# Architecture

## Connectors and Trim





1 1/2" Screen to 3 1/2" Frame Connector Kits

# System

- Configurations include all hardware and finished trim to create the configuration
- Two sided off-module brackets are specified when frames are off module on both sides of the "spine" panel
- Specify code based on height of frames within connection
- The connection kits may be used in conjunction with Stack-on Connectors and vertical trim to create multi-height connections
- 1.5" screen connectors are available for tapered trim only
- **(3F)** suffix is based on the spine panel thickness

### NOTES

Be sure to specify correct thickness of connector kit based on the frame thickness

		Part number	H	Wt (lbs)	Neutral paint/ base price	Accent paint
	Off-Module (1side)	<b>INFSPOMC-3F</b>	—	2	\$103	—
	Off-Module (2side) screens must be off module at same locations on spine back to back	<b>INFSPOMB-3F</b>	—	2	\$156	—
	"L" Connector 1 1/2" left side	<b>INFSPLC37LH-3F</b>	37"	2	\$139	+\$17
		<b>INFSPLC44LH-3F</b>	44"	2	\$148	+\$18
		<b>INFSPLC51LH-3F</b>	51"	2	\$152	+\$18
		<b>INFSPLC64LH-3F</b>	64"	2	\$192	+\$22
	"L" Connector 1 1/2" right side	<b>INFSPLC37RH-3F</b>	37"	2	\$139	+\$17
		<b>INFSPLC44RH-3F</b>	44"	2	\$148	+\$18
		<b>INFSPLC51RH-3F</b>	51"	2	\$152	+\$18
		<b>INFSPLC64RH-3F</b>	64"	2	\$192	+\$22

## Architecture

### Connectors and Trim



1 1/2" Screen to 3 1/2" Frame Connector Kits

# System

- Configurations include all hardware and finished trim to create the configuration
- Specify code based on height of frames within connection
- The connection kits may be used in conjunction with Stack-on Connectors and vertical trim to create multi-height connections
- 1.5" screen connectors are available for tapered trim only
- **(3F)** suffix is based on the spine panel thickness.

### NOTES

Be sure to specify correct thickness of connector kit based on the frame thickness

		Part number	H	Wt (lbs)	Neutral paint/ base price	Accent paint
	"T" Connector 1x3 1/2" Frame	<b>INFPSTC37-3F</b>	37"	2	\$174	+\$20
		<b>INFPSTC44-3F</b>	44"	2	\$180	+\$21
		<b>INFPSTC51-3F</b>	51"	2	\$199	+\$22
		<b>INFPSTC64-3F</b>	64"	2	\$223	+\$25
	"X" Connection 2x1 1/2" Screens, 2x3 1/2" Frames	<b>INFPSXC37-3F</b>	37"	2	\$111	+\$15
		<b>INFPSXC44-3F</b>	44"	2	\$114	+\$15
		<b>INFPSXC51-3F</b>	51"	2	\$118	+\$15
		<b>INFPSXC64-3F</b>	64"	2	\$121	+\$16

# Architecture

## Connectors and Trim

### 2 3/4" Frame to 3 1/2" Frame Same Height Connector Kits

# System

- Configurations include all hardware and finished trim to create the configuration
- Specify code based on height of frames within connection
- The connection kits may be used in conjunction with Stack-on Connectors and vertical trim to create multi-height connections

#### NOTES

- Number in diagrams depict panel thickness
- Lefts and rights are determined from the inside view of the connection

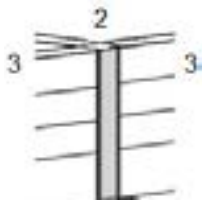
	Part number	H	Thickness	Neutral paint/ base price	Accent paint
 <p>"T" Connector 2x3 1/2" Frame, 1x2 3/4" Frames</p>	<b>INMHC24-332</b>	24"	2 3/4"	\$170	+\$20
	<b>INMHC29-332</b>	29"	2 3/4"	\$172	+\$20
	<b>INMHC37-332</b>	37"	2 3/4"	\$179	+\$21
	<b>INMHC44-332</b>	44"	2 3/4"	\$185	+\$21
	<b>INMHC51-332</b>	51"	2 3/4"	\$191	+\$22
	<b>INMHC57-332</b>	57"	2 3/4"	\$197	+\$22
	<b>INMHC64-332</b>	64"	2 3/4"	\$289	+\$31







# Architecture

Connectors and Trim  
Planna Storage Benching End Trim

# System

- Includes mounting hardware to attach to the adjacent storage cases
- 3 1/2" thick version only
- Specific for worksurface or cushion above
- Specify whether a cutout is required to allow electrical feed and data cabling to enter frame behind

		Part number	H	W	Wt (lbs)	Neutral paint/ base price	Accent paint
	End Trim with Electrical Cutout, Worksurface compatible (worksurface above)	<b>PLNCETCO</b>	25"	3.5"	2	\$91	+\$12
	End Trim without Cutout / Private Office Case Back Filler, Worksurface compatible (worksurface above)	<b>PLNCET</b>	25"	3.5"	2	\$88	+\$12
	End Trim with Electrical Cutout, Cushion compatible (cushion above)	<b>PLNCETCOCUSH</b>	25"	3.5"	2	\$73	+\$11
	End Trim without Cutout / Private Office Case Back Filler, Cushion compatible (cushion above)	<b>PLNCETCUSH</b>	25"	3.5"	2	\$69	+\$10

Tiles are available as fabric, painted, tackable, Nuform, Double Glazed and whiteboard. Tiles are interchangeable between 2.75" and 3.5" frame thickness (the thickness of the frame is determined by the tile clips which come with the frame). Tile heights vary and must always align with a crossrail on the frame as this is where the tile clips are located. If alternative tile configurations are required, additional crossrails may be specified separately and installed in the field (crossrails will include tile clips depending on thickness opted for). Tiles may be positioned in any location unless otherwise stated or crossrail does not permit.

Tiles are held in place by tile clips. These clips snap between panel crossrails and may easily be removed and/or replaced if necessary when changing the thickness of the panel. Clips support panel tiles and top trim. The clips are made of Delrin which is a resin similar to nylon in strength but has more rigidity and superior memory. These characteristics allow the Inscape System clips to retain their original shape without permanently deforming under continual pressure. This ensures tiles and trim will snap into place with a solid "click" time after time.

### FABRIC AND PAINTED TILES

Fabric and painted tiles are available 27", 20.25" and 6.75" H, as well as 13.5" and are constructed from 24 gauge galvanized steel. Powder-coated and fabric-covered steel tiles have a flame spread rating of less than 200 when tested according to ASTM-E84. Fabric-covered tiles are available in standard fabrics or COM. COM fabrics are subject to approval. White or extremely light colored COM fabrics will incur an upcharge of 25% to the tile pricing with which the fabric is being applied. This is due to special handling of the fabric and tiles, in addition to painting of the tiles. Painted tiles are available in the colors shown in our Color Guide and are available in the following styles: plain steel, perforated, and steel screen. Fabric on tiles is applied in a railroad orientation.

### TACKABLE TILES

Tackable tiles are constructed from 24 gauge cold rolled steel with a paint finish on all surfaces to prevent corrosion. The same general rules from the fabric tile section apply to the Tackable tiles. Fabric on tiles is applied in a railroad orientation. NRC 0.57, STC 9.

**Tackable Acoustical tiles are available through Standard Specials with NRC of .73 and an STC of 12.**

Nuform Tiles consist of gray melamine-backed MDF substrate 0.375" thick, with vacuum-formed Nuform foil over the front's surface and sides. The back-side of the tile also has routing features that accept zinc die-cast tile clips. All Nuform tiles incorporate a stiffener on the rear of the tile to ensure straightness and rigidity. This stiffener limits where the tile may be placed on a 2.75" thick frame. Nuform tiles cannot be specified in a location where a power track is installed due to interference. A sticker on the back of Nuform tiles provides UL flame / smoke-rating information. Woodgrain pattern is vertical. Due to limitations in the foil size, 48" and wider tiles are not available in F06 Walnut.

### WHITEBOARD TILES

Whiteboard tiles are available in two heights, 13.5" and 20.25". Tiles are constructed from 24 gauge cold rolled steel with optional white, gray or black paint finishes that has been specifically formulated for dry erase markers. Whiteboards are seamless and fit same locations as standard painted tiles.

**NOTE: Inscape whiteboards are specifically designed for use with DRY-ERASE markers only. WHITEBOARDS ARE NOT INTENDED FOR USE WITH PERMANENT MARKERS. Inscape advises the use of Sanford Expo Dry Erase markers with whiteboards. For a thorough cleaning, use Sanford Expo spray cleaner.**

## PAPER MANAGEMENT TILES

Paper management tiles support horizontal paper management accessories. Organizers may be positioned at any point along the width of the tile. Three slats structured into the tile allow for three different height options for the accessories to be installed. Accessories may be found under Horizontal Accessories under the "Storage and Accessories" section. Maximum load capacity is 75lbs. When specifying paper management tiles which will be supporting a monitor arm, a Paper Management Reinforcing kit is required for additional structure. The 54" and 60" w tiles are pre-structured with these kits.

## PERFORATED TILES

Perforated tiles are constructed of 24 gauge galvanized steel, the Steel Screen tiles are constructed from 24 gauge cold rolled steel. Tiles may be painted in any of Inscape's standard colors or color matches.

## COMMUNICATION TILES

Communication tiles provide power OR data access. The 24" and 30" W include one cutout while all wider tile widths include two cutouts. Tiles provide electrical access in frames 30"w and wider only and data access in all panel widths. Bezels in tile may be specified in black, white (close match to P290 – Aluminum Leaf) and gray (close match to P326 – Moonlight) as well with the data or electrical components. Bezels are flush with tile, NOT recessed.

## FABRIC/FINISHES & WORKSURFACE GENERAL NOTES

Fabric patterns which are available in 54" and 55" both have limitations on the sizes of tiles available. Tile sizes longer than 42" are not available.

Codes with the following suffix have specific install locations

<b>UD</b>	Upper Deck
<b>BL</b>	Beltline
<b>BS</b>	Base

## MULTI ACCESS TILES

Multi access tiles provide electrical AND data access. Cutouts align with power track and proper tiles must be specified in specific areas if stated. Data and Electrical components may be specified from the Technology section. Bezels in tile may be specified in black, white (close match to P168 – Glacier White) and gray (close match to P290 – Aluminum Leaf) as well with the data or electrical components. Bezels are flush with tile, NOT recessed.

Codes with the following suffix have specific install locations

<b>UD</b>	Upper Deck
<b>BL</b>	Beltline
<b>BS</b>	Base

## MONOLITHIC TILES

Monolithic tiles are specified based on the height and width of the frame with which they are being installed. Monolithic tiles are available in painted or fabric (fabric wrapped steel).

## DOUBLE GLAZED TILES

Double glazed tiles are available in 13.5" H and may be installed on frames 24" to 48" W in place of a tile. Double Glazed tiles feature a double pane of frosted acrylic or clear acrylic framed by vertical and horizontal trim. Double Glazed tiles may be installed one on top of another. If wider than 60" of glaze is desired; Stack on Double Glazed Kits may be specified.

## PLANNA MULTI ACCESS TILE

The Planna multi access tile is required for termination of electrical and data at points behind the Planna case. The multi access tile can be optioned in any standard paint color. The multi access tile designed for Planna includes proper hardware to mount the tile to the frame. Be sure to specify electrical components such as the Upper Deck electrical kit, duplexes and phone/ data components separately.

This tile is only structured in conjunction with the 3.5" thickness.

LEGEND

● Available



Tile Height & Type		Tile Width													
		18"	24"	30"	36"	42"	48"	54"	60"	66"	72"	78"	84"	90"	96"
6.75"H	Painted	●	●	●	●	●	●	●	●						
13.5"H	Painted	●	●	●	●	●	●	●	●	●	●	●	●	●	●
20.25"H	Painted	●	●	●	●	●	●	●	●	●	●	●	●	●	●
27"H	Painted	●	●	●	●	●	●	●	●						
37"H	Monolithic painted	●	●	●	●	●	●	●	●						
44"H	Monolithic painted	●	●	●	●	●	●	●	●						
51"H	Monolithic painted	●	●	●	●	●	●	●	●						
57"H	Monolithic painted	●	●	●	●	●	●	●	●						
64"H	Monolithic painted	●	●	●	●	●	●	●	●						
6.75"H	Fabric	●	●	●	●	●	●	●	●						
13.5"H	Fabric	●	●	●	●	●	●	●	●	●	●	●	●	●	●
20.25"H	Fabric	●	●	●	●	●	●	●	●	●	●	●	●	●	●
27"H	Fabric	●	●	●	●	●	●								
37"H	Monolithic fabric	●	●	●	●	●	●								
44"H	Monolithic fabric	●	●	●	●	●	●								
51"H	Monolithic fabric	●	●	●	●	●	●								
57"H	Monolithic fabric	●	●	●	●	●	●								
64"H	Monolithic fabric	●	●	●	●	●	●								
13.5"H	Tackable	●	●	●	●	●	●								
20.25"H	Tackable	●	●	●	●	●	●								
6.75"H	Nuform	●	●	●	●	●	●								
13.5"H	Nuform	●	●	●	●	●	●								
20.25"H	Nuform	●	●	●	●	●	●								
27"H	Nuform	●	●	●	●	●	●								
13.5"H	Whiteboard	●	●	●	●	●	●	●	●	●	●	●	●	●	●
20.25"H	Whiteboard	●	●	●	●	●	●	●	●	●	●	●	●	●	●
6.75"H	Paper management	●	●	●	●	●	●	●	●	●	●	●	●	●	●
13.5"H	Double glazed		●	●	●	●	●								
6.75"H	Comm - UD - fabric/painted		●	●	●	●	●	●	●						
13.5"H	Comm - UD - fabric/painted		●	●	●	●	●	●	●						
20.25"H	Comm - BS - fabric/painted		●	●	●	●	●	●	●						
6.75"H	Comm - BL - fabric/painted		●	●	●	●	●	●	●						
13.5"H	Comm - BL - fabric/painted		●	●	●	●	●	●	●						
6.75"H	Planna m/a - UD -fabric/painted			●	●	●									
6.75"H	M/A - UD - fabric/painted				●	●	●	●	●						
13.5"H	M/A - UD - fabric/painted				●	●	●	●	●						
20.25"H	M/A - BS - fabric/painted				●	●	●	●	●						
6.75"H	M/A - BL - fabric/painted				●	●	●	●	●						
13.5"H	M/A - BL - fabric/painted				●	●	●	●	●						

**PRODUCT CODE  
KEY EXAMPLE**

IN6.75P18

<b>IN</b>	Inscape System
<b>6.75</b>	6.75" H
<b>P</b>	Painted
<b>18</b>	18" W

- Painted tiles are available in any of Inscape's standard paint colors or a custom color can be accommodated
- Painted tile is magnetic
- Be sure to confirm crossrail locations will accommodate tile height
- Crossrails can be found in the accessory section of the price list under Panel and Table accessories
- Tiles 66"W or wider span two frames. See Application Guide for frame spanning guidelines



		Part number	H	W	Neutral paint/ base price	Accent paint
	6.75" H Painted Tile	<b>IN6.75P18</b>	6.75"	18"	\$58	+\$9
		<b>IN6.75P24</b>	6.75"	24"	\$63	+\$10
		<b>IN6.75P30</b>	6.75"	30"	\$69	+\$10
		<b>IN6.75P36</b>	6.75"	36"	\$71	+\$10
		<b>IN6.75P42</b>	6.75"	42"	\$72	+\$11
		<b>IN6.75P48</b>	6.75"	48"	\$76	+\$11
		<b>IN6.75P54</b>	6.75"	54"	\$79	+\$11
		<b>IN6.75P60</b>	6.75"	60"	\$84	+\$11
	13.5" H Painted Tile	<b>IN13.5P18</b>	13.5"	18"	\$59	+\$9
		<b>IN13.5P24</b>	13.5"	24"	\$65	+\$10
		<b>IN13.5P30</b>	13.5"	30"	\$71	+\$10
		<b>IN13.5P36</b>	13.5"	36"	\$72	+\$11
		<b>IN13.5P42</b>	13.5"	42"	\$74	+\$11
		<b>IN13.5P48</b>	13.5"	48"	\$77	+\$11
		<b>IN13.5P54</b>	13.5"	54"	\$81	+\$11
		<b>IN13.5P60</b>	13.5"	60"	\$86	+\$12
		<b>IN13.5P66</b>	13.5"	66"	\$178	+\$21
		<b>IN13.5P72</b>	13.5"	72"	\$184	+\$21
		<b>IN13.5P78</b>	13.5"	78"	\$188	+\$21
		<b>IN13.5P84</b>	13.5"	84"	\$194	+\$22
		<b>IN13.5P90</b>	13.5"	90"	\$197	+\$22
<b>IN13.5P96</b>	13.5"	96"	\$199	+\$22		

**PRODUCT CODE  
KEY EXAMPLE**

IN6.75P18

<b>IN</b>	Inscape System
<b>6.75</b>	6.75" H
<b>P</b>	Painted
<b>18</b>	18" W

- Painted tiles are available in any of Inscape's standard paint colors or a custom color can be accommodated
- Painted tile is magnetic
- Be sure to confirm crossrail locations will accommodate tile height
- Crossrails can be found in the accessory section of the price list under Panel and Table accessories
- Tiles 66"W or wider span two frames. See Application Guide for frame spanning guidelines

		Part number	H	W	Neutral paint/ base price	Accent paint
	20.25" H Painted Tile	<b>IN20.25P18</b>	20.25"	18"	\$77	+\$11
		<b>IN20.25P24</b>	20.25"	24"	\$81	+\$11
		<b>IN20.25P30</b>	20.25"	30"	\$86	+\$12
		<b>IN20.25P36</b>	20.25"	36"	\$90	+\$12
		<b>IN20.25P42</b>	20.25"	42"	\$92	+\$12
		<b>IN20.25P48</b>	20.25"	48"	\$94	+\$12
		<b>IN20.25P54</b>	20.25"	54"	\$99	+\$13
		<b>IN20.25P60</b>	20.25"	60"	\$102	+\$13
		<b>IN20.25P66</b>	20.25"	66"	\$208	+\$23
		<b>IN20.25P72</b>	20.25"	72"	\$213	+\$24
		<b>IN20.25P78</b>	20.25"	78"	\$219	+\$24
		<b>IN20.25P84</b>	20.25"	84"	\$223	+\$25
	27" H Painted Tile	<b>IN27P18</b>	27"	18"	\$92	+\$12
		<b>IN27P24</b>	27"	24"	\$94	+\$12
		<b>IN27P30</b>	27"	30"	\$97	+\$13
		<b>IN27P36</b>	27"	36"	\$112	+\$15
		<b>IN27P42</b>	27"	42"	\$121	+\$16
		<b>IN27P48</b>	27"	48"	\$137	+\$17

**PRODUCT CODE  
KEY EXAMPLE**

IN6.75F18

<b>IN</b>	Inscape System
<b>6.75</b>	6.75" H
<b>F</b>	Fabric
<b>18</b>	18" W

- Fabric applied in a railroad orientation as standard
- Fabric tile is magnetic
- Be sure to confirm crossrail locations will accommodate tile height
- Crossrails can be found in the accessory section of the price list under Panel and Table accessories
- Tiles 66" W or wider span two frames. See Application Guide for frame spanning guidelines

**NOTES**



See finishes section for fabrics that require scrim.

Tile size limitations exist for some fabrics, see finishes section.

In order to get a total cost on products when upcharges are present take the list price of the product number and add the upcharge cost shown to the list price.

For example:

Product IN6.75F18 in Grade 2 with scrim would be \$86 +\$7 +\$15

	Part number	W	Grade 1/ COM/ Base price	Grade 2	Grade 3	Grade 4	Grade 5	Grade 6	Grade 7	Grade 8	Scrim
 <p>6.75" H Fabric Tile</p>	<b>IN6.75F18</b>	18"	\$86	+\$7	+\$10	+\$15	+\$18	+\$32	+\$48	+\$65	+\$15
	<b>IN6.75F24</b>	24"	\$89	+\$8	+\$11	+\$17	+\$21	+\$36	+\$53	+\$73	+\$15
	<b>IN6.75F30</b>	30"	\$91	+\$9	+\$12	+\$17	+\$21	+\$37	+\$54	+\$76	+\$15
	<b>IN6.75F36</b>	36"	\$93	+\$9	+\$12	+\$22	+\$31	+\$52	+\$73	+\$102	+\$16
	<b>IN6.75F42</b>	42"	\$96	+\$10	+\$16	+\$24	+\$32	+\$54	+\$77	+\$106	+\$16
	<b>IN6.75F48</b>	48"	\$98	+\$10	+\$16	+\$24	+\$32	+\$54	+\$77	+\$106	+\$16
	<b>IN6.75F54</b>	54"	\$99	+\$11	+\$20	+\$26	+\$33	+\$58	+\$84	+\$114	+\$16
	<b>IN6.75F60</b>	60"	\$102	+\$12	+\$21	+\$29	+\$35	+\$60	+\$87	+\$119	+\$17
 <p>13.5" H Fabric Tile</p>	<b>IN13.5F18</b>	18"	\$98	+\$7	+\$22	+\$24	+\$31	+\$46	+\$61	+\$87	+\$16
	<b>IN13.5F24</b>	24"	\$101	+\$7	+\$24	+\$27	+\$34	+\$45	+\$60	+\$86	+\$16
	<b>IN13.5F30</b>	30"	\$105	+\$8	+\$26	+\$33	+\$37	+\$45	+\$61	+\$87	+\$17
	<b>IN13.5F36</b>	36"	\$110	+\$12	+\$26	+\$35	+\$45	+\$67	+\$92	+\$128	+\$17
	<b>IN13.5F42</b>	42"	\$116	+\$15	+\$27	+\$36	+\$47	+\$72	+\$98	+\$135	+\$18
	<b>IN13.5F48</b>	48"	\$120	+\$15	+\$27	+\$36	+\$47	+\$72	+\$99	+\$137	+\$18
	<b>IN13.5F54</b>	54"	\$124	+\$16	+\$29	+\$42	+\$52	+\$81	+\$106	+\$147	+\$20
	<b>IN13.5F60</b>	60"	\$129	+\$16	+\$29	+\$42	+\$52	+\$81	+\$106	+\$147	+\$20
	<b>IN13.5F66</b>	66"	\$239	+\$17	+\$29	+\$42	+\$52	+\$83	+\$107	+\$151	+\$93
	<b>IN13.5F72</b>	72"	\$243	+\$17	+\$18	+\$25	+\$33	+\$66	+\$99	+\$137	+\$94
	<b>IN13.5F78</b>	78"	\$245	+\$17	+\$20	+\$27	+\$35	+\$71	+\$105	+\$146	+\$94
	<b>IN13.5F84</b>	84"	\$255	+\$18	+\$20	+\$27	+\$35	+\$71	+\$105	+\$146	+\$96
	<b>IN13.5F90</b>	90"	\$256	+\$18	+\$21	+\$31	+\$42	+\$77	+\$112	+\$157	+\$118
<b>IN13.5F96</b>	96"	\$259	+\$19	+\$22	+\$33	+\$45	+\$84	+\$119	+\$166	+\$118	

**PRODUCT CODE  
KEY EXAMPLE**

IN6.75F18

<b>IN</b>	Inscape System
<b>6.75</b>	6.75" H
<b>F</b>	Fabric
<b>18</b>	18" W

- Fabric applied in a railroad orientation as standard
- Fabric tile is magnetic
- Be sure to confirm crossrail locations will accommodate tile height
- Crossrails can be found in the accessory section of the price list under Panel and Table accessories
- Tiles 66" W or wider span two frames. See Application Guide for frame spanning guidelines

**NOTES**



See finishes section for fabrics that require scrim.

Tile size limitations exist for some fabrics, see finishes section.

In order to get a total cost on products when upcharges are present take the list price of the product number and add the upcharge cost shown to the list price.

For example:

Product IN20.25F18 in Grade 2 with scrim would be \$116 +\$7 +\$27

	Part number	W	Grade 1/ COM/ Base price	Grade 2	Grade 3	Grade 4	Grade 5	Grade 6	Grade 7	Grade 8	Scrim
 20.25" H Fabric Tile	<b>IN20.25F18</b>	18"	\$116	+\$7	+\$13	+\$23	+\$33	+\$54	+\$76	+\$105	+\$27
	<b>IN20.25F24</b>	24"	\$127	+\$8	+\$20	+\$29	+\$37	+\$61	+\$86	+\$118	+\$27
	<b>IN20.25F30</b>	30"	\$133	+\$8	+\$21	+\$30	+\$39	+\$63	+\$88	+\$120	+\$29
	<b>IN20.25F36</b>	36"	\$140	+\$9	+\$22	+\$33	+\$45	+\$71	+\$99	+\$137	+\$30
	<b>IN20.25F42</b>	42"	\$147	+\$9	+\$16	+\$30	+\$45	+\$72	+\$101	+\$140	+\$31
	<b>IN20.25F48</b>	48"	\$156	+\$11	+\$29	+\$42	+\$52	+\$86	+\$115	+\$161	+\$31
	<b>IN20.25F54</b>	54"	\$160	+\$11	+\$31	+\$46	+\$59	+\$94	+\$128	+\$177	+\$32
	<b>IN20.25F60</b>	60"	\$170	+\$13	+\$44	+\$58	+\$73	+\$108	+\$144	+\$202	+\$33
	<b>IN20.25F66</b>	66"	\$293	+\$13	+\$44	+\$59	+\$74	+\$110	+\$145	+\$204	+\$97
	<b>IN20.25F72</b>	72"	\$296	+\$13	+\$44	+\$59	+\$74	+\$110	+\$145	+\$204	+\$98
	<b>IN20.25F78</b>	78"	\$304	+\$27	+\$33	+\$48	+\$60	+\$107	+\$156	+\$216	+\$98
	<b>IN20.25F84</b>	84"	\$319	+\$30	+\$34	+\$50	+\$65	+\$114	+\$164	+\$226	+\$121
	<b>IN20.25F90</b>	90"	\$322	+\$31	+\$37	+\$54	+\$70	+\$121	+\$172	+\$240	+\$121
	<b>IN20.25F96</b>	96"	\$326	+\$32	+\$39	+\$58	+\$76	+\$130	+\$182	+\$253	+\$124
 27" H Fabric Tile	<b>IN27F18</b>	18"	\$134	+\$7	+\$15	+\$25	+\$35	+\$63	+\$90	+\$125	+\$27
	<b>IN27F24</b>	24"	\$139	+\$8	+\$15	+\$26	+\$39	+\$67	+\$97	+\$134	+\$29
	<b>IN27F30</b>	30"	\$147	+\$9	+\$16	+\$29	+\$44	+\$73	+\$104	+\$144	+\$30
	<b>IN27F36</b>	36"	\$157	+\$10	+\$22	+\$35	+\$49	+\$86	+\$119	+\$166	+\$31
	<b>IN27F42</b>	42"	\$171	+\$11	+\$24	+\$37	+\$51	+\$88	+\$125	+\$171	+\$32
	<b>IN27F48</b>	48"	\$174	+\$12	+\$26	+\$42	+\$54	+\$94	+\$133	+\$185	+\$33



# Architecture

Tiles  
Tackable

# System

## PRODUCT CODE KEY EXAMPLE

IN13.5TK18

<b>IN</b>	Inscape System
<b>13.5</b>	13.5" H
<b>TK</b>	Tackable
<b>18</b>	18" W

- Fabric applied in a railroad orientation as standard
- Fabric tile is magnetic
- NRC 0.55, STC 9
- Wall Mount Tile Kit must match height of tile
- It is recommended that tackable tiles are not to be used on the outside of a workstation
- Be sure to confirm crossrail locations will accommodate tile height
- Crossrails can be found in the accessory section of the price list under Panel and Table accessories

## NOTES



See finishes section for fabrics that require scrim.

Tile size limitations exist for some fabrics, see finishes section.

In order to get a total cost on products when upcharges are present take the list price of the product number and add the upcharge cost shown to the list price.

For example:

Product IN13.5TK18 in Grade 2 with scrim would be \$145 +\$7 +\$25

	Part number	W	Grade 1/ COM/ Base price	Grade 2	Grade 3	Grade 4	Grade 5	Grade 6	Grade 7	Grade 8	Scrim
 13.5" H Tackable Tile	<b>IN13.5TK18</b>	18"	\$145	+\$7	+\$11	+\$20	+\$29	+\$51	+\$73	+\$102	+\$25
	<b>IN13.5TK24</b>	24"	\$151	+\$8	+\$12	+\$21	+\$29	+\$52	+\$74	+\$103	+\$27
	<b>IN13.5TK30</b>	30"	\$156	+\$9	+\$12	+\$21	+\$29	+\$53	+\$77	+\$106	+\$29
	<b>IN13.5TK36</b>	36"	\$160	+\$12	+\$22	+\$32	+\$44	+\$73	+\$103	+\$143	+\$30
	<b>IN13.5TK42</b>	42"	\$165	+\$13	+\$23	+\$33	+\$45	+\$76	+\$106	+\$147	+\$32
	<b>IN13.5TK48</b>	48"	\$187	+\$13	+\$23	+\$35	+\$48	+\$84	+\$115	+\$161	+\$33
 20.25" H Tackable Tile	<b>IN20.25TK18</b>	18"	\$216	+\$6	+\$13	+\$22	+\$31	+\$56	+\$83	+\$111	+\$27
	<b>IN20.25TK24</b>	24"	\$220	+\$8	+\$15	+\$25	+\$36	+\$64	+\$92	+\$128	+\$30
	<b>IN20.25TK30</b>	30"	\$223	+\$9	+\$15	+\$26	+\$39	+\$76	+\$112	+\$157	+\$32
	<b>IN20.25TK36</b>	36"	\$228	+\$10	+\$22	+\$33	+\$46	+\$81	+\$114	+\$160	+\$34
	<b>IN20.25TK42</b>	42"	\$233	+\$10	+\$16	+\$27	+\$39	+\$73	+\$106	+\$147	+\$36
	<b>IN20.25TK48</b>	48"	\$238	+\$12	+\$22	+\$36	+\$51	+\$88	+\$121	+\$169	+\$39
 33.75" H Tackable Tile	<b>IN33.75TK18</b>	18"	\$324	+\$15	+\$22	+\$30	+\$37	+\$73	+\$108	+\$152	+\$32
	<b>IN33.75TK24</b>	24"	\$342	+\$16	+\$22	+\$30	+\$37	+\$76	+\$112	+\$157	+\$35
	<b>IN33.75TK30</b>	30"	\$360	+\$16	+\$26	+\$31	+\$39	+\$79	+\$118	+\$165	+\$42
	<b>IN33.75TK36</b>	36"	\$380	+\$30	+\$34	+\$51	+\$66	+\$119	+\$170	+\$237	+\$45
	<b>IN33.75TK42</b>	42"	\$399	+\$30	+\$35	+\$51	+\$66	+\$121	+\$174	+\$245	+\$48
	<b>IN33.75TK48</b>	48"	\$416	+\$31	+\$36	+\$53	+\$69	+\$127	+\$182	+\$253	+\$52

	Part number	Neutral paint/ base price	Accent paint
	<b>WMTL13</b>	\$60	+\$9
	<b>WMTL20</b>	\$63	+\$10

Wall Mount Tackable Tile  
Kits



**PRODUCT CODE  
KEY EXAMPLE**

IN6.75NF18

<b>IN</b>	Inscape System
<b>6.75</b>	6.75" H
<b>NF</b>	Nuform
<b>18</b>	18" W

- Stiffener bar prevents installation of this tile in any location where power track is installed in a 2 ¾" frame. See Inscape System Application Guide
- Some tile configurations require crossrails to be cut and additional crossrails ordered separately, See Inscape System Application Guide
- Be sure to confirm crossrail locations will accommodate tile height

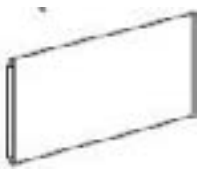
- Crossrails can be found in the accessory section of the price list under Panel and Table accessories
- Due to limitations in the foil size, 48" and wider tiles are not available in F06 Walnut
- Direction of woodgrain is vertical

		Part number	H	W	Nuform classic/ base price	Nuform select
	6.75" H Nuform Tile	<b>IN6.75NF18</b>	6.75"	18"	\$235	+\$27
		<b>IN6.75NF24</b>	6.75"	24"	\$243	+\$27
		<b>IN6.75NF30</b>	6.75"	30"	\$250	+\$29
		<b>IN6.75NF36</b>	6.75"	36"	\$255	+\$30
		<b>IN6.75NF42</b>	6.75"	42"	\$262	+\$30
		<b>IN6.75NF48</b>	6.75"	48"	\$268	+\$31
	13.5" H Nuform Tile	<b>IN13.5NF18</b>	13.5"	18"	\$247	+\$29
		<b>IN13.5NF24</b>	13.5"	24"	\$253	+\$29
		<b>IN13.5NF30</b>	13.5"	30"	\$263	+\$30
		<b>IN13.5NF36</b>	13.5"	36"	\$274	+\$31
		<b>IN13.5NF42</b>	13.5"	42"	\$286	+\$33
		<b>IN13.5NF48</b>	13.5"	48"	\$293	+\$33
	20.25" H Nuform Tile	<b>IN20.25NF18</b>	20.25"	18"	\$283	+\$32
		<b>IN20.25NF24</b>	20.25"	24"	\$294	+\$34
		<b>IN20.25NF30</b>	20.25"	30"	\$316	+\$36
		<b>IN20.25NF36</b>	20.25"	36"	\$331	+\$37
		<b>IN20.25NF42</b>	20.25"	42"	\$344	+\$39
		<b>IN20.25NF48</b>	20.25"	48"	\$358	+\$42
	27" H Nuform Tile	<b>IN27NF18</b>	27"	18"	\$293	+\$33
		<b>IN27NF24</b>	27"	24"	\$310	+\$35
		<b>IN27NF30</b>	27"	30"	\$329	+\$37
		<b>IN27NF36</b>	27"	36"	\$345	+\$39
		<b>IN27NF42</b>	27"	42"	\$362	+\$42
		<b>IN27NF48</b>	27"	48"	\$380	+\$44

**PRODUCT CODE  
KEY EXAMPLE**

IN13.5NFPHE18

<b>IN</b>	Inscape System
<b>13.5</b>	13.5" H
<b>NFP</b>	Nuform patterned tile
<b>HE</b>	Herringbone
<b>18</b>	18" W





- Only available for use on 37", 44" and 51" H frames
- Patterned tiles must be applied in specific configurations based on the height of the frame in order for the pattern to line up correctly
- Due to limitations in the foil size, 48" and wider tiles are not available in F06 Walnut
- Direction of woodgrain is horizontal

**NOTES**

Patterned tiles cannot be used with the following as they will interfere with the installation:

- Off-module brackets
- Power poles
- Worksurfaces front edge support brackets
- Up-mount bins
- Transaction Tops
- Electrical covers
- Dekko power tracks for 2 3/4" frames

Can only be used on the outside face of a workstation



		Part number	H	W	Nuform classic/ 2 3/4" thick frame/ Base price	3 1/2" thick frame	Nuform select
	13.5" H Nuform Patterned Tile, Herringbone for top location only	<b>IN13.5NFPHE72</b>	13.5"	72"	\$602	+\$22	+\$67
		<b>IN13.5NFPHE84</b>	13.5"	84"	\$625	+\$47	+\$70
		<b>IN13.5NFPHE96</b>	13.5"	96"	\$654	+\$51	+\$73
	20.25" H Nuform Patterned Tile, Herringbone for top location only	<b>IN20.25NFPHE72</b>	20.25"	72"	\$667	+\$23	+\$74
		<b>IN20.25NFPHE84</b>	20.25"	84"	\$699	+\$48	+\$79
		<b>IN20.25NFPHE96</b>	20.25"	96"	\$741	+\$51	+\$84
	20.25" H Nuform Patterned Tile, Herringbone for bottom location only	<b>IN20.25NFPHEB72</b>	20.25"	72"	\$667	+\$23	+\$74
		<b>IN20.25NFPHEB84</b>	20.25"	84"	\$699	+\$48	+\$79
		<b>IN20.25NFPHEB96</b>	20.25"	96"	\$741	+\$51	+\$84
	27" H Nuform Patterned Tile, Herringbone for bottom location only	<b>IN27NFPHEB72</b>	27"	72"	\$845	+\$31	+\$94
		<b>IN27NFPHEB84</b>	27"	84"	\$888	+\$69	+\$99
		<b>IN27NFPHEB96</b>	27"	96"	\$944	+\$76	+\$105

**PRODUCT CODE  
KEY EXAMPLE**

IN13.5WB18

<b>IN</b>	Inscape System
<b>13.5</b>	13.5" H
<b>WB</b>	Whiteboard
<b>18</b>	18" W

- Only Expo Markers are to be used on any Inscape Whiteboard. Whiteboards should be cleaned with Expo Eraser or a Microfiber cleaning cloth along with Expo Cleaning Solution which is formulated to remove residue from Expo Dry Erase Markers
  - Be sure to confirm crossrail locations will accommodate tile height
  - Wall Mount Tile Kit must match height of tile
  - Tiles 66" W or wider span two frames.
- \*See Application Guide for frame spanning guidelines*

	Part number	H	W	List price
	13.5" H Whiteboard Tile			
	<b>IN13.5WB18</b>	13.5"	18"	\$96
	<b>IN13.5WB24</b>	13.5"	24"	\$100
	<b>IN13.5WB30</b>	13.5"	30"	\$103
	<b>IN13.5WB36</b>	13.5"	36"	\$105
	<b>IN13.5WB42</b>	13.5"	42"	\$107
	<b>IN13.5WB48</b>	13.5"	48"	\$114
	<b>IN13.5WB54</b>	13.5"	54"	\$127
	<b>IN13.5WB60</b>	13.5"	60"	\$132
	<b>IN13.5WB66</b>	13.5"	66"	\$227
	<b>IN13.5WB72</b>	13.5"	72"	\$234
	<b>IN13.5WB78</b>	13.5"	78"	\$245
	<b>IN13.5WB84</b>	13.5"	84"	\$250
<b>IN13.5WB90</b>	13.5"	90"	\$255	
<b>IN13.5WB96</b>	13.5"	96"	\$262	
	20.25" H Whiteboard Tile			
	<b>IN20.25WB18</b>	20.25"	18"	\$104
	<b>IN20.25WB24</b>	20.25"	24"	\$110
	<b>IN20.25WB30</b>	20.25"	30"	\$115
	<b>IN20.25WB36</b>	20.25"	36"	\$120
	<b>IN20.25WB42</b>	20.25"	42"	\$127
	<b>IN20.25WB48</b>	20.25"	48"	\$131
	<b>IN20.25WB54</b>	20.25"	54"	\$153
	<b>IN20.25WB60</b>	20.25"	60"	\$159
	<b>IN20.25WB66</b>	20.25"	66"	\$240
	<b>IN20.25WB72</b>	20.25"	72"	\$248
	<b>IN20.25WB78</b>	20.25"	78"	\$255
	<b>IN20.25WB84</b>	20.25"	84"	\$264
<b>IN20.25WB90</b>	20.25"	90"	\$273	
<b>IN20.25WB96</b>	20.25"	96"	\$281	
	Wall Mount Tackable Tile Kits			
	<b>WMTL13</b>	13.5"	—	\$60
	<b>WMTL20</b>	20.25"	—	\$63



**PRODUCT CODE  
 KEY EXAMPLE**

IN6.75PM18-3F	
<b>IN</b>	Inscape System
<b>6.75</b>	6.75" H
<b>PM</b>	Paper Management
<b>18</b>	18" W
<b>3F</b>	3 1/2" thick frame application

- "2F" denotes use with 2 3/4" thick frame, "3F" denotes use with 3 1/2" thick frame
- Be sure to confirm crossrail locations will accommodate tile configuration
- Paper management tiles are not to be installed below the work surface
- Tiles 66" W or wider span two frames. See Application Guide for frame spanning guidelines

**NOTES**

54" and 60" W Paper Management tiles include reinforcing brackets

		Part number	H	W	Neutral paint/ base price	Accent paint
	6.75" H Paper Management Tile for use with 3 1/2" T frames	<b>IN6.75PM18-3F</b>	6.75"	18"	\$126	+\$16
		<b>IN6.75PM24-3F</b>	6.75"	24"	\$140	+\$17
		<b>IN6.75PM30-3F</b>	6.75"	30"	\$160	+\$19
		<b>IN6.75PM36-3F</b>	6.75"	36"	\$174	+\$20
		<b>IN6.75PM42-3F</b>	6.75"	42"	\$195	+\$22
		<b>IN6.75PM48-3F</b>	6.75"	48"	\$211	+\$23
		<b>IN6.75PM54-3F</b>	6.75"	54"	\$227	+\$25
		<b>IN6.75PM60-3F</b>	6.75"	60"	\$249	+\$27
		<b>IN6.75PM66-3F</b>	6.75"	66"	\$336	+\$35
		<b>IN6.75PM72-3F</b>	6.75"	72"	\$348	+\$36
		<b>IN6.75PM78-3F</b>	6.75"	78"	\$358	+\$37
		<b>IN6.75PM84-3F</b>	6.75"	84"	\$410	+\$44
		<b>IN6.75PM90-3F</b>	6.75"	90"	\$424	+\$46
<b>IN6.75PM96-3F</b>	6.75"	96"	\$436	+\$47		
	6.75" H Paper Management Tile for use with 2 3/4" T frames	<b>IN6.75PM18-2F</b>	6.75"	18"	\$126	+\$16
		<b>IN6.75PM24-2F</b>	6.75"	24"	\$140	+\$17
		<b>IN6.75PM30-2F</b>	6.75"	30"	\$160	+\$19
		<b>IN6.75PM36-2F</b>	6.75"	36"	\$174	+\$20
		<b>IN6.75PM42-2F</b>	6.75"	42"	\$195	+\$22
		<b>IN6.75PM48-2F</b>	6.75"	48"	\$211	+\$23
		<b>IN6.75PM54-2F</b>	6.75"	54"	\$227	+\$25
		<b>IN6.75PM60-2F</b>	6.75"	60"	\$249	+\$27
		<b>IN6.75PM66-2F</b>	6.75"	66"	\$328	+\$34
		<b>IN6.75PM72-2F</b>	6.75"	72"	\$341	+\$36
		<b>IN6.75PM78-2F</b>	6.75"	78"	\$353	+\$37
		<b>IN6.75PM84-2F</b>	6.75"	84"	\$401	+\$44
		<b>IN6.75PM90-2F</b>	6.75"	90"	\$414	+\$45
<b>IN6.75PM96-2F</b>	6.75"	96"	\$429	+\$46		

# Architecture

Tiles

Paper Management Tile Reinforcing Kit

# System

**PRODUCT CODE  
KEY EXAMPLE**

INPMRK-3F



**IN** Inscape System

**PM** Paper Management

**RK** Reinforcement Kit

**3F** 3 1/2" thick frame

- “2F” denotes use with 2.75" thick frame, “3F” denotes use with 3.5" thick frame
- When specifying monitor arms to mount on paper management tile, reinforcing bracket must be specified (frame thickness specific)
- Reinforcement Kit includes reinforcing brackets for Paper Management Tile



		Part number	H	W	List price
	Paper Management Reinforcing Kit for use with 3 1/2" T frames	<b>INPMRK-3F</b>	—	18"	\$126
	Paper Management Reinforcing Kit for use with 2 3/4" T frames	<b>INPMRK-2F</b>	—	18"	\$126

**PRODUCT CODE  
KEY EXAMPLE**

IN13.5PF18

<b>IN</b>	Inscape System
<b>13.5</b>	13.5" H
<b>PF</b>	Perforated
<b>18</b>	18" W

- Perforated tiles are available in any of Inscape's standard paint colors or a custom color can be accommodated
- Painted tile is magnetic
- Be sure to confirm crossrail locations will accommodate tile height
- Crossrails can be found in the accessory section of the price list under Panel and Table accessories

		Part number	H	W	Neutral paint/ base price	Accent paint
	13.5" H Perforated Tile	<b>IN13.5PF18</b>	13.5"	18"	\$74	+\$11
		<b>IN13.5PF24</b>	13.5"	24"	\$77	+\$11
		<b>IN13.5PF30</b>	13.5"	30"	\$86	+\$12
		<b>IN13.5PF36</b>	13.5"	36"	\$87	+\$12
		<b>IN13.5PF42</b>	13.5"	42"	\$88	+\$12
		<b>IN13.5PF48</b>	13.5"	48"	\$91	+\$12
		<b>IN13.5PF54</b>	13.5"	54"	\$92	+\$12
		<b>IN13.5PF60</b>	13.5"	60"	\$94	+\$12
	20.25" H Perforated Tile	<b>IN20.25PF18</b>	20.25"	18"	\$90	+\$12
		<b>IN20.25PF24</b>	20.25"	24"	\$92	+\$12
		<b>IN20.25PF30</b>	20.25"	30"	\$94	+\$12
		<b>IN20.25PF36</b>	20.25"	36"	\$100	+\$13
		<b>IN20.25PF42</b>	20.25"	42"	\$103	+\$13
		<b>IN20.25PF48</b>	20.25"	48"	\$107	+\$15
		<b>IN20.25PF54</b>	20.25"	54"	\$112	+\$15
		<b>IN20.25PF60</b>	20.25"	60"	\$116	+\$15
	27" H Perforated Tile	<b>IN27PF18</b>	27"	18"	\$102	+\$13
		<b>IN27PF24</b>	27"	24"	\$104	+\$13
		<b>IN27PF30</b>	27"	30"	\$106	+\$13
		<b>IN27PF36</b>	27"	36"	\$108	+\$15
		<b>IN27PF42</b>	27"	42"	\$119	+\$15
		<b>IN27PF48</b>	27"	48"	\$127	+\$16

# Architecture

## Tiles

Communication - Painted

# System

### PRODUCT CODE KEY EXAMPLE

IN6.75CTP24-UD

<b>IN</b>	Inscape System
<b>6.75</b>	6.75" H
<b>CTP</b>	Painted Communication Tile
<b>24</b>	24" W
<b>UD</b>	Upper deck location

- Painted tiles are available in any of Inscape's standard paint colors or a custom color can be accommodated
- Painted tile is magnetic
- Specific locations where these tiles may be installed on frame; \*See *Inscape System Application Guide*
- Flush bezel color option of black, white and gray (default black)
- Be sure to confirm crossrail locations will accommodate tile height
- Crossrails are required with the 6.75"h bottom location tiles
- Crossrails can be found in the accessory section of the price list under Panel and Table accessories





### NOTES

Code suffix denote specific tile location:

UD = Upper deck

BL = Beltline

BS = Base

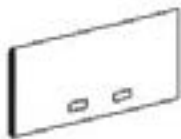
		Part number	H	W	Neutral paint/ base price	Accent paint
	6.75" H Painted Communication Tile Upper Deck Location	<b>IN6.75CTP24-UD</b>	6.75"	24"	\$71	+\$10
		<b>IN6.75CTP30-UD</b>	6.75"	30"	\$74	+\$11
		<b>IN6.75CTP36-UD</b>	6.75"	36"	\$76	+\$11
		<b>IN6.75CTP42-UD</b>	6.75"	42"	\$79	+\$11
		<b>IN6.75CTP48-UD</b>	6.75"	48"	\$81	+\$11
		<b>IN6.75CTP54-UD</b>	6.75"	54"	\$87	+\$12
		<b>IN6.75CTP60-UD</b>	6.75"	60"	\$90	+\$12
	13.5" H Painted Communication Tile Upper Deck Location	<b>IN13.5CTP24-UD</b>	13.5"	24"	\$99	+\$13
		<b>IN13.5CTP30-UD</b>	13.5"	30"	\$102	+\$13
		<b>IN13.5CTP36-UD</b>	13.5"	36"	\$107	+\$15
		<b>IN13.5CTP42-UD</b>	13.5"	42"	\$112	+\$15
		<b>IN13.5CTP48-UD</b>	13.5"	48"	\$119	+\$15
		<b>IN13.5CTP54-UD</b>	13.5"	54"	\$120	+\$16
		<b>IN13.5CTP60-UD</b>	13.5"	60"	\$124	+\$16
	6.75" H Painted Communication Tile Beltline Location	<b>IN6.75CTP24-BL</b>	6.75"	24"	\$71	+\$10
		<b>IN6.75CTP30-BL</b>	6.75"	30"	\$74	+\$11
		<b>IN6.75CTP36-BL</b>	6.75"	36"	\$76	+\$11
		<b>IN6.75CTP42-BL</b>	6.75"	42"	\$79	+\$11
		<b>IN6.75CTP48-BL</b>	6.75"	48"	\$81	+\$11
		<b>IN6.75CTP54-BL</b>	6.75"	54"	\$87	+\$12
		<b>IN6.75CTP60-BL</b>	6.75"	60"	\$90	+\$12
	13.5" H Painted Communication Tile Beltline Location	<b>IN13.5CTP24-BL</b>	13.5"	24"	\$99	+\$13
		<b>IN13.5CTP30-BL</b>	13.5"	30"	\$102	+\$13
		<b>IN13.5CTP36-BL</b>	13.5"	36"	\$107	+\$15
		<b>IN13.5CTP42-BL</b>	13.5"	42"	\$112	+\$15
		<b>IN13.5CTP48-BL</b>	13.5"	48"	\$119	+\$15
		<b>IN13.5CTP54-BL</b>	13.5"	54"	\$120	+\$16
		<b>IN13.5CTP60-BL</b>	13.5"	60"	\$124	+\$16
	6.75" H Painted Communication Tile Bottom Location	<b>IN6.75CTP30-BS</b>	6.75"	30"	\$91	+\$9
		<b>IN6.75CTP36-BS</b>	6.75"	36"	\$98	+\$9
		<b>IN6.75CTP42-BS</b>	6.75"	42"	\$103	+\$10
		<b>IN6.75CTP48-BS</b>	6.75"	48"	\$114	+\$11
	20.25" H Painted Communication Tile Bottom Location	<b>IN20.25CTP24-BS</b>	20.25"	24"	\$124	+\$16
		<b>IN20.25CTP30-BS</b>	20.25"	30"	\$128	+\$16
		<b>IN20.25CTP36-BS</b>	20.25"	36"	\$135	+\$17
		<b>IN20.25CTP42-BS</b>	20.25"	42"	\$144	+\$18
		<b>IN20.25CTP48-BS</b>	20.25"	48"	\$151	+\$18
		<b>IN20.25CTP54-BS</b>	20.25"	54"	\$169	+\$20
		<b>IN20.25CTP60-BS</b>	20.25"	60"	\$172	+\$20



# Architecture

Tiles

Communication - Fabric

# System

## PRODUCT CODE KEY EXAMPLE

IN6.75CTF24-UD

<b>IN</b>	Inscape System
<b>6.75</b>	6.75" H
<b>CTF</b>	Fabric Communication Tile
<b>24</b>	24" W
<b>UD</b>	Upper deck location

- Fabric applied in a railroad orientation as standard
- Fabric tile is magnetic.
- Specific locations where these tiles may be installed on frame; \*See *Inscape System Application Guide*
- Flush bezel color option of black, white and gray (default black)
- Be sure to confirm crossrail locations will accommodate tile height
- Crossrails can be found in the accessory section of the price list under Panel and Table accessories

## NOTES

Code suffix denote specific tile location:

UD = Upper deck

BL = Beltline

BS = Base





See finishes section for fabrics that requires scrim.

Tile size limitations exist for some fabrics, see finishes section.

In order to get a total cost on products when upcharges are present take the list price of the product number and add the upcharge cost shown to the list price.

For example:

Product IN6.75CTF24-UD in Grade 2 with scrim would be \$91 +\$7 +\$15

	Part number	W	Grade 1/ COM/ Base price	Grade 2	Grade 3	Grade 4	Grade 5	Grade 6	Grade 7	Grade 8	Scrim
 6.75" H Fabric Communication Tile Upper Deck Location	<b>IN6.75CTF24-UD</b>	24"	\$91	+\$7	+\$9	+\$13	+\$18	+\$35	+\$53	+\$73	+\$15
	<b>IN6.75CTF30-UD</b>	30"	\$93	+\$7	+\$9	+\$13	+\$18	+\$35	+\$53	+\$73	+\$15
	<b>IN6.75CTF36-UD</b>	36"	\$105	+\$9	+\$12	+\$21	+\$30	+\$52	+\$74	+\$103	+\$16
	<b>IN6.75CTF42-UD</b>	42"	\$110	+\$10	+\$11	+\$20	+\$27	+\$50	+\$72	+\$101	+\$16
	<b>IN6.75CTF48-UD</b>	48"	\$114	+\$10	+\$13	+\$22	+\$30	+\$53	+\$77	+\$106	+\$16
	<b>IN6.75CTF54-UD</b>	54"	\$120	+\$11	+\$13	+\$22	+\$30	+\$54	+\$79	+\$108	+\$16
	<b>IN6.75CTF60-UD</b>	60"	\$131	+\$11	+\$13	+\$24	+\$34	+\$63	+\$91	+\$127	+\$17
 13.5" H Fabric Communication Tile Upper Deck Location	<b>IN13.5CTF24-UD</b>	24"	\$114	+\$9	+\$15	+\$23	+\$31	+\$54	+\$79	+\$108	+\$16
	<b>IN13.5CTF30-UD</b>	30"	\$119	+\$8	+\$12	+\$21	+\$29	+\$53	+\$77	+\$106	+\$17
	<b>IN13.5CTF36-UD</b>	36"	\$131	+\$9	+\$16	+\$27	+\$39	+\$69	+\$98	+\$135	+\$17
	<b>IN13.5CTF42-UD</b>	42"	\$134	+\$10	+\$20	+\$29	+\$37	+\$71	+\$100	+\$140	+\$18
	<b>IN13.5CTF48-UD</b>	48"	\$139	+\$12	+\$25	+\$35	+\$46	+\$76	+\$106	+\$147	+\$18
	<b>IN13.5CTF54-UD</b>	54"	\$140	+\$13	+\$27	+\$39	+\$50	+\$84	+\$114	+\$160	+\$20
	<b>IN13.5CTF60-UD</b>	60"	\$153	+\$15	+\$16	+\$27	+\$42	+\$73	+\$105	+\$146	+\$20
 6.75" H Fabric Communication Tile Beltline Location	<b>IN6.75CTF24-BL</b>	24"	\$91	+\$7	+\$9	+\$13	+\$18	+\$35	+\$53	+\$73	+\$15
	<b>IN6.75CTF30-BL</b>	30"	\$93	+\$7	+\$9	+\$13	+\$18	+\$35	+\$53	+\$73	+\$15
	<b>IN6.75CTF36-BL</b>	36"	\$105	+\$9	+\$10	+\$21	+\$25	+\$52	+\$74	+\$103	+\$16
	<b>IN6.75CTF42-BL</b>	42"	\$110	+\$10	+\$11	+\$21	+\$27	+\$50	+\$72	+\$101	+\$16
	<b>IN6.75CTF48-BL</b>	48"	\$114	+\$10	+\$12	+\$22	+\$30	+\$53	+\$77	+\$106	+\$16
	<b>IN6.75CTF54-BL</b>	54"	\$120	+\$11	+\$13	+\$22	+\$30	+\$54	+\$79	+\$108	+\$16
	<b>IN6.75CTF60-BL</b>	60"	\$131	+\$11	+\$13	+\$24	+\$34	+\$63	+\$91	+\$127	+\$17
 13.5" H Fabric Communication Tile Beltline Location	<b>IN13.5CTF24-BL</b>	24"	\$114	+\$8	+\$15	+\$23	+\$31	+\$54	+\$79	+\$108	+\$16
	<b>IN13.5CTF30-BL</b>	30"	\$119	+\$9	+\$15	+\$25	+\$34	+\$53	+\$77	+\$106	+\$17
	<b>IN13.5CTF36-BL</b>	36"	\$131	+\$9	+\$16	+\$27	+\$39	+\$69	+\$98	+\$135	+\$17
	<b>IN13.5CTF42-BL</b>	42"	\$134	+\$10	+\$20	+\$29	+\$43	+\$71	+\$100	+\$143	+\$18
	<b>IN13.5CTF48-BL</b>	48"	\$139	+\$12	+\$25	+\$35	+\$46	+\$76	+\$106	+\$147	+\$18
	<b>IN13.5CTF54-BL</b>	54"	\$140	+\$13	+\$27	+\$39	+\$50	+\$84	+\$114	+\$160	+\$20
	<b>IN13.5CTF60-BL</b>	60"	\$153	+\$15	+\$27	+\$42	+\$52	+\$86	+\$116	+\$162	+\$20

# Architecture

## Tiles

Communication - Fabric

# System

IN6.75CTF24-UD

<b>IN</b>	Inscape System
<b>6.75</b>	6.75" H
<b>CTF</b>	Fabric Communication Tile
<b>24</b>	24" W
<b>UD</b>	Upper deck location

- Fabric applied in a railroad orientation as standard
- Fabric tile is magnetic.
- Specific locations where these tiles may be installed on frame; \*See *Inscape System Application Guide*
- Flush bezel color option of black, white and gray (default black)
- Be sure to confirm crossrail locations will accommodate tile height
- Crossrails can be found in the accessory section of the price list under Panel and Table accessories

### NOTES

Code suffix denote specific tile location:

UD = Upper deck

BL = Beltline

BS = Base

See finishes section for fabrics that requires scrim.

Tile size limitations exist for some fabrics, see finishes section.

In order to get a total cost on products when upcharges are present take the list price of the product number and add the upcharge cost shown to the list price.

For example:

Product IN20.25CTF24-BS in Grade 2 with scrim would be \$137 +\$8 +\$27

Part number	W	Grade 1/ COM/ Base price	Grade 2	Grade 3	Grade 4	Grade 5	Grade 6	Grade 7	Grade 8	Scrim
<b>IN20.25CTF24-BS</b>	24"	\$137	+\$8	+\$21	+\$31	+\$42	+\$71	+\$101	+\$140	+\$27
<b>IN20.25CTF30-BS</b>	30"	\$139	+\$7	+\$22	+\$32	+\$44	+\$73	+\$103	+\$143	+\$29
<b>IN20.25CTF36-BS</b>	36"	\$162	+\$9	+\$22	+\$34	+\$48	+\$85	+\$119	+\$166	+\$30
<b>IN20.25CTF42-BS</b>	42"	\$167	+\$10	+\$25	+\$37	+\$51	+\$88	+\$126	+\$174	+\$31
<b>IN20.25CTF48-BS</b>	48"	\$171	+\$12	+\$29	+\$44	+\$56	+\$96	+\$133	+\$185	+\$31
<b>IN20.25CTF54-BS</b>	54"	\$174	+\$12	+\$31	+\$47	+\$61	+\$103	+\$143	+\$201	+\$32
<b>IN20.25CTF60-BS</b>	60"	\$179	+\$13	+\$42	+\$58	+\$74	+\$119	+\$162	+\$225	+\$33

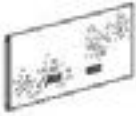

20.25" H Fabric Communication Tile Bottom Location

# Architecture

Tiles  
Multi Access - Painted

# System

## PRODUCT CODE KEY EXAMPLE

IN6.75MAP30-UD

<b>IN</b>	Inscape System
<b>6.75</b>	6.75" H
<b>MAP</b>	Painted Multi Access Tile
<b>30</b>	30" W
<b>UD</b>	Upper deck location

- Painted tiles are available in any of Inscape's standard paint colors or a custom color can be accommodated
- Painted tile is magnetic
- Specific locations where these tiles may be installed on frame; \*See *Inscape System Application Guide*
- Flush bezel color option of black (default), white and gray
- Be sure to confirm crossrail locations will accommodate tile height
- Crossrails can be found in the accessory section of the price list under Panel and Table accessories





## NOTES

Code suffix denote specific tile location:

UD = Upper deck

BL = Beltline

BS = Base

		Part number	H	W	Neutral paint/ base price	Accent paint
	6.75" H Painted Multi Access Tile Upper Deck Location	<b>IN6.75MAP30-UD</b>	6.75"	30"	\$74	+\$11
		<b>IN6.75MAP36-UD</b>	6.75"	36"	\$76	+\$11
		<b>IN6.75MAP42-UD</b>	6.75"	42"	\$79	+\$11
		<b>IN6.75MAP48-UD</b>	6.75"	48"	\$81	+\$11
		<b>IN6.75MAP54-UD</b>	6.75"	54"	\$87	+\$12
		<b>IN6.75MAP60-UD</b>	6.75"	60"	\$90	+\$12
	13.5" H Painted Multi Access Tile Upper Deck Location	<b>IN13.5MAP30-UD</b>	13.5"	30"	\$103	+\$13
		<b>IN13.5MAP36-UD</b>	13.5"	36"	\$107	+\$15
		<b>IN13.5MAP42-UD</b>	13.5"	42"	\$112	+\$15
		<b>IN13.5MAP48-UD</b>	13.5"	48"	\$119	+\$15
		<b>IN13.5MAP54-UD</b>	13.5"	54"	\$120	+\$16
		<b>IN13.5MAP60-UD</b>	13.5"	60"	\$124	+\$16
	6.75" H Painted Multi Access Tile Beltline Location	<b>IN6.75MAP30-BL</b>	6.75"	30"	\$74	+\$11
		<b>IN6.75MAP36-BL</b>	6.75"	36"	\$76	+\$11
		<b>IN6.75MAP42-BL</b>	6.75"	42"	\$79	+\$11
		<b>IN6.75MAP48-BL</b>	6.75"	48"	\$81	+\$11
		<b>IN6.75MAP54-BL</b>	6.75"	54"	\$87	+\$12
		<b>IN6.75MAP60-BL</b>	6.75"	60"	\$90	+\$12
	13.5" H Painted Multi Access Tile Beltline Location	<b>IN13.5MAP30-BL</b>	13.5"	30"	\$103	+\$13
		<b>IN13.5MAP36-BL</b>	13.5"	36"	\$107	+\$15
		<b>IN13.5MAP42-BL</b>	13.5"	42"	\$112	+\$15
		<b>IN13.5MAP48-BL</b>	13.5"	48"	\$119	+\$15
		<b>IN13.5MAP54-BL</b>	13.5"	54"	\$120	+\$16
		<b>IN13.5MAP60-BL</b>	13.5"	60"	\$124	+\$16
	20.25" H Painted Multi Access Tile Bottom Location	<b>IN20.25MAP30-BS</b>	20.25"	30"	\$138	+\$17
		<b>IN20.25MAP36-BS</b>	20.25"	36"	\$140	+\$17
		<b>IN20.25MAP42-BS</b>	20.25"	42"	\$147	+\$18
		<b>IN20.25MAP48-BS</b>	20.25"	48"	\$157	+\$19
		<b>IN20.25MAP54-BS</b>	20.25"	54"	\$174	+\$20
		<b>IN20.25MAP60-BS</b>	20.25"	60"	\$178	+\$21

# Architecture

Tiles  
Multi Access - Fabric

# System

## PRODUCT CODE KEY EXAMPLE

IN6.75MAF30

<b>IN</b>	Inscape System
<b>6.75</b>	6.75" H
<b>MAF</b>	Multi Access Fabric
<b>30</b>	30" W

- Fabric applied in a railroad orientation as standard
- Fabric tile is magnetic.
- Specific locations where these tiles may be installed on frame; \*See *Inscape System Application Guide*
- Flush bezel color option of black (default), white and gray
- Be sure to confirm crossrail locations will accommodate tile height
- Crossrails can be found in the accessory section of the price list under Panel and Table accessories

## NOTES

Code suffix denote specific tile location:

UD = Upper deck

BL = Beltline

BS = Base





See finishes section for fabrics that requires scrim

Tile size limitations exist for some fabrics, see finishes section

In order to get a total cost on products when upcharges are present take the list price of the product number and add the upcharge cost shown to the list price.

For example:

Product IN6.75MAF30-UD in Grade 2 with scrim would be \$94 +\$7 +\$15

	Part number	W	Grade 1/ COM/ Base price	Grade 2	Grade 3	Grade 4	Grade 5	Grade 6	Grade 7	Grade 8	Scrim
 6.75" H Fabric Multi Access Tile Upper Deck Location	<b>IN6.75MAF30-UD</b>	30"	\$94	+\$7	+\$9	+\$13	+\$18	+\$35	+\$53	+\$73	+\$15
	<b>IN6.75MAF36-UD</b>	36"	\$105	+\$9	+\$12	+\$21	+\$25	+\$50	+\$70	+\$97	+\$16
	<b>IN6.75MAF42-UD</b>	42"	\$110	+\$10	+\$11	+\$21	+\$27	+\$52	+\$72	+\$101	+\$16
	<b>IN6.75MAF48-UD</b>	48"	\$114	+\$10	+\$13	+\$22	+\$30	+\$53	+\$77	+\$106	+\$16
	<b>IN6.75MAF54-UD</b>	54"	\$120	+\$11	+\$13	+\$22	+\$30	+\$54	+\$79	+\$108	+\$16
	<b>IN6.75MAF60-UD</b>	60"	\$131	+\$11	+\$13	+\$24	+\$34	+\$63	+\$91	+\$127	+\$17
 13.5" H Fabric Multi Access Tile Upper Deck Location	<b>IN13.5MAF30-UD</b>	30"	\$120	+\$8	+\$12	+\$21	+\$29	+\$53	+\$77	+\$106	+\$17
	<b>IN13.5MAF36-UD</b>	36"	\$131	+\$9	+\$16	+\$27	+\$39	+\$69	+\$98	+\$135	+\$17
	<b>IN13.5MAF42-UD</b>	42"	\$134	+\$10	+\$23	+\$29	+\$44	+\$72	+\$103	+\$143	+\$18
	<b>IN13.5MAF48-UD</b>	48"	\$139	+\$12	+\$25	+\$35	+\$46	+\$76	+\$106	+\$147	+\$18
	<b>IN13.5MAF54-UD</b>	54"	\$140	+\$13	+\$27	+\$39	+\$50	+\$84	+\$114	+\$160	+\$20
	<b>IN13.5MAF60-UD</b>	60"	\$153	+\$15	+\$30	+\$43	+\$52	+\$87	+\$116	+\$162	+\$20
 6.75" H Fabric Multi Access Tile Beltline Location	<b>IN6.75MAF30-BL</b>	30"	\$94	+\$7	+\$9	+\$13	+\$18	+\$35	+\$53	+\$73	+\$15
	<b>IN6.75MAF36-BL</b>	36"	\$105	+\$9	+\$11	+\$21	+\$26	+\$48	+\$61	+\$88	+\$16
	<b>IN6.75MAF42-BL</b>	42"	\$110	+\$10	+\$11	+\$21	+\$27	+\$50	+\$72	+\$101	+\$16
	<b>IN6.75MAF48-BL</b>	48"	\$114	+\$10	+\$13	+\$22	+\$30	+\$53	+\$77	+\$106	+\$16
	<b>IN6.75MAF54-BL</b>	54"	\$120	+\$11	+\$13	+\$22	+\$30	+\$54	+\$79	+\$108	+\$16
	<b>IN6.75MAF60-BL</b>	60"	\$131	+\$11	+\$13	+\$24	+\$34	+\$63	+\$91	+\$127	+\$17
 13.5" H Fabric Multi Access Tile Beltline Location	<b>IN13.5MAF30-BL</b>	30"	\$120	+\$7	+\$12	+\$21	+\$29	+\$53	+\$77	+\$106	+\$17
	<b>IN13.5MAF36-BL</b>	36"	\$131	+\$9	+\$16	+\$27	+\$34	+\$65	+\$96	+\$121	+\$17
	<b>IN13.5MAF42-BL</b>	42"	\$134	+\$8	+\$20	+\$29	+\$37	+\$67	+\$98	+\$135	+\$18
	<b>IN13.5MAF48-BL</b>	48"	\$139	+\$12	+\$25	+\$35	+\$46	+\$76	+\$106	+\$147	+\$18
	<b>IN13.5MAF54-BL</b>	54"	\$140	+\$13	+\$27	+\$39	+\$50	+\$84	+\$114	+\$160	+\$20
	<b>IN13.5MAF60-BL</b>	60"	\$153	+\$6	+\$16	+\$27	+\$42	+\$73	+\$105	+\$146	+\$20
 20.25" H Fabric Multi Access Tile Bottom Location	<b>IN20.25MAF30-BS</b>	30"	\$140	+\$7	+\$22	+\$32	+\$44	+\$73	+\$103	+\$143	+\$29
	<b>IN20.25MAF36-BS</b>	36"	\$162	+\$9	+\$22	+\$34	+\$48	+\$85	+\$119	+\$166	+\$30
	<b>IN20.25MAF42-BS</b>	42"	\$167	+\$9	+\$20	+\$33	+\$47	+\$85	+\$119	+\$166	+\$31
	<b>IN20.25MAF48-BS</b>	48"	\$171	+\$12	+\$29	+\$44	+\$56	+\$96	+\$133	+\$185	+\$31
	<b>IN20.25MAF54-BS</b>	54"	\$174	+\$12	+\$31	+\$47	+\$61	+\$103	+\$143	+\$201	+\$32
	<b>IN20.25MAF60-BS</b>	60"	\$179	+\$15	+\$33	+\$58	+\$74	+\$119	+\$162	+\$225	+\$33

# Architecture

Tiles  
Double Glazed

# System

## PRODUCT CODE KEY EXAMPLE

IN13.5GL24-3F

<b>IN</b>	Inscape System
<b>1.35</b>	13.5" H
<b>GL24</b>	24" W double glaze
<b>3F</b>	for 3 1/2" thick frame

- "2F" denotes use with 2 3/4" thick frame, "3F" denotes use with 3 1/2" thick frame
- Be sure to confirm crossrail locations will accommodate tile height
- Crossrails can be found in the accessory section of the price list under Panel and Table accessories



## NOTES

Standard tiles may NOT be installed in locations above Double Glaze Tile on the 2 3/4" thick frame

In order to get a total cost on products when upcharges are present take the list price of the product number and add the upcharge cost shown to the list price.

For example:

IN13.5GL24-3F in Frosted Acrylic would be \$329 +\$42





		Part number	H	W	Clear acrylic/ base price	Frosted acrylic	Accent paint
	Double Glaze Tile for 3 1/2" Frames	<b>IN13.5GL24-3F</b>	13.5"	24"	\$329	+\$42	+\$35
		<b>IN13.5GL30-3F</b>	13.5"	30"	\$343	+\$54	+\$36
		<b>IN13.5GL36-3F</b>	13.5"	36"	\$356	+\$58	+\$37
		<b>IN13.5GL42-3F</b>	13.5"	42"	\$381	+\$88	+\$42
		<b>IN13.5GL48-3F</b>	13.5"	48"	\$391	+\$98	+\$43
	Double Glaze Tile for 2 3/4" Frames	<b>IN13.5GL24-2F</b>	13.5"	24"	\$317	+\$42	+\$33
		<b>IN13.5GL30-2F</b>	13.5"	30"	\$331	+\$54	+\$35
		<b>IN13.5GL36-2F</b>	13.5"	36"	\$344	+\$58	+\$36
		<b>IN13.5GL42-2F</b>	13.5"	42"	\$369	+\$88	+\$39
		<b>IN13.5GL48-2F</b>	13.5"	48"	\$378	+\$98	+\$42

**PRODUCT CODE  
 KEY EXAMPLE**

IN37P18

<b>IN</b>	Inscape System
<b>37</b>	37" H
<b>P</b>	Painted
<b>18</b>	18" W

- Painted tiles are available in any of Inscape's standard paint colors or a custom color can be accommodated
- Painted tile is magnetic.
- Be sure to confirm crossrail locations will accommodate tile height
- Crossrails can be found in the accessory section of the price list under Panel and Table accessories

		Part number	H	W	Neutral paint/ base price	Accent paint
	37" H Painted Monolithic Tile	<b>IN37P18</b>	37"	18"	\$171	+\$20
		<b>IN37P24</b>	37"	24"	\$177	+\$20
		<b>IN37P30</b>	37"	30"	\$180	+\$21
		<b>IN37P36</b>	37"	36"	\$185	+\$21
		<b>IN37P42</b>	37"	42"	\$188	+\$21
		<b>IN37P48</b>	37"	48"	\$192	+\$22
	44" H Painted Monolithic Tile	<b>IN44P18</b>	44"	18"	\$197	+\$22
		<b>IN44P24</b>	44"	24"	\$204	+\$23
		<b>IN44P30</b>	44"	30"	\$211	+\$23
		<b>IN44P36</b>	44"	36"	\$218	+\$24
		<b>IN44P42</b>	44"	42"	\$225	+\$25
		<b>IN44P48</b>	44"	48"	\$231	+\$25
	51" H Painted Monolithic Tile	<b>IN51P18</b>	51"	18"	\$209	+\$23
		<b>IN51P24</b>	51"	24"	\$219	+\$24
		<b>IN51P30</b>	51"	30"	\$223	+\$25
		<b>IN51P36</b>	51"	36"	\$231	+\$25
		<b>IN51P42</b>	51"	42"	\$243	+\$26
		<b>IN51P48</b>	51"	48"	\$252	+\$27
	57" H Painted Monolithic Tile	<b>IN57P18</b>	57"	18"	\$221	+\$24
		<b>IN57P24</b>	57"	24"	\$231	+\$25
		<b>IN57P30</b>	57"	30"	\$245	+\$26
		<b>IN57P36</b>	57"	36"	\$251	+\$27
		<b>IN57P42</b>	57"	42"	\$260	+\$29
		<b>IN57P48</b>	57"	48"	\$273	+\$30
	64" H Painted Monolithic Tile	<b>IN64P18</b>	64"	18"	\$247	+\$26
		<b>IN64P24</b>	64"	24"	\$262	+\$29
		<b>IN64P30</b>	64"	30"	\$278	+\$30
		<b>IN64P36</b>	64"	36"	\$294	+\$32
		<b>IN64P42</b>	64"	42"	\$306	+\$33
		<b>IN64P48</b>	64"	48"	\$317	+\$33

# Architecture

Tiles  
Monolithic - Fabric

# System

## PRODUCT CODE KEY EXAMPLE

IN37F18

<b>IN</b>	Inscape System
<b>37</b>	37" H
<b>F</b>	Fabric
<b>18</b>	18" W

- Fabric applied in a railroad orientation as standard
- Fabric tile is magnetic
- Be sure to confirm crossrail locations will accommodate tile height
- Crossrails can be found in the accessory section of the price list under Panel and Table accessories

## NOTES





See finishes section for fabrics that requires scrim.

Tile size limitations exist for some fabrics, see finishes section.

In order to get a total cost on products when upcharges are present take the list price of the product number and add the upcharge cost shown to the list price.

For example:

Product IN37F18 in Grade 2 with scrim would be \$258 +\$15 +\$33

	Part number	W	Grade 1/ COM/ Base price	Grade 2	Grade 3	Grade 4	Grade 5	Grade 6	Grade 7	Grade 8	Scrim
	<b>IN37F18</b>	18"	\$258	+\$15	+\$21	+\$30	+\$37	+\$73	+\$108	+\$152	+\$33
	<b>IN37F24</b>	24"	\$272	+\$16	+\$22	+\$30	+\$37	+\$76	+\$112	+\$157	+\$44
	<b>IN37F30</b>	30"	\$283	+\$16	+\$22	+\$31	+\$39	+\$79	+\$118	+\$165	+\$53
	<b>IN37F36</b>	36"	\$294	+\$30	+\$34	+\$51	+\$66	+\$119	+\$170	+\$237	+\$63
	<b>IN37F42</b>	42"	\$312	+\$30	+\$35	+\$51	+\$66	+\$121	+\$174	+\$245	+\$72
	<b>IN37F48</b>	48"	\$322	+\$31	+\$36	+\$53	+\$69	+\$127	+\$182	+\$253	+\$85
37" H Fabric Monolithic Tile											
	<b>IN44F18</b>	18"	\$287	+\$20	+\$23	+\$33	+\$45	+\$84	+\$120	+\$168	+\$39
	<b>IN44F24</b>	24"	\$304	+\$20	+\$23	+\$33	+\$45	+\$86	+\$126	+\$173	+\$52
	<b>IN44F30</b>	30"	\$319	+\$22	+\$25	+\$34	+\$46	+\$89	+\$130	+\$180	+\$64
	<b>IN44F36</b>	36"	\$333	+\$33	+\$42	+\$45	+\$73	+\$133	+\$194	+\$273	+\$76
	<b>IN44F42</b>	42"	\$348	+\$33	+\$42	+\$57	+\$77	+\$139	+\$200	+\$276	+\$90
	<b>IN44F48</b>	48"	\$364	+\$33	+\$42	+\$59	+\$77	+\$139	+\$200	+\$278	+\$101
44" H Fabric Monolithic Tile											
	<b>IN51F18</b>	18"	\$314	+\$21	+\$25	+\$36	+\$47	+\$89	+\$129	+\$178	+\$46
	<b>IN51F24</b>	24"	\$328	+\$22	+\$26	+\$37	+\$50	+\$96	+\$139	+\$195	+\$60
	<b>IN51F30</b>	30"	\$343	+\$24	+\$27	+\$42	+\$58	+\$98	+\$143	+\$204	+\$74
	<b>IN51F36</b>	36"	\$357	+\$34	+\$30	+\$63	+\$83	+\$140	+\$199	+\$277	+\$91
	<b>IN51F42</b>	42"	\$374	+\$35	+\$46	+\$64	+\$84	+\$143	+\$206	+\$286	+\$104
	<b>IN51F48</b>	48"	\$388	+\$37	+\$48	+\$66	+\$87	+\$145	+\$210	+\$292	+\$120
51" H Fabric Monolithic Tile											
	<b>IN57F18</b>	18"	\$326	+\$26	+\$32	+\$46	+\$57	+\$104	+\$152	+\$211	+\$51
	<b>IN57F24</b>	24"	\$342	+\$29	+\$33	+\$47	+\$59	+\$111	+\$164	+\$226	+\$66
	<b>IN57F30</b>	30"	\$357	+\$34	+\$37	+\$48	+\$61	+\$116	+\$170	+\$237	+\$85
	<b>IN57F36</b>	36"	\$375	+\$44	+\$49	+\$77	+\$98	+\$168	+\$238	+\$331	+\$99
	<b>IN57F42</b>	42"	\$394	+\$45	+\$53	+\$81	+\$99	+\$170	+\$242	+\$336	+\$115
	<b>IN57F48</b>	48"	\$411	+\$46	+\$56	+\$84	+\$100	+\$174	+\$250	+\$348	+\$131
57" H Fabric Monolithic Tile											
	<b>IN64F18</b>	18"	\$348	+\$26	+\$32	+\$46	+\$57	+\$104	+\$152	+\$211	+\$57
	<b>IN64F24</b>	24"	\$369	+\$29	+\$34	+\$47	+\$59	+\$111	+\$164	+\$226	+\$74
	<b>IN64F30</b>	30"	\$387	+\$33	+\$42	+\$48	+\$61	+\$116	+\$170	+\$237	+\$94
	<b>IN64F36</b>	36"	\$407	+\$37	+\$56	+\$77	+\$98	+\$168	+\$238	+\$331	+\$112
	<b>IN64F42</b>	42"	\$430	+\$44	+\$57	+\$81	+\$102	+\$170	+\$242	+\$336	+\$131
	<b>IN64F48</b>	48"	\$449	+\$46	+\$59	+\$84	+\$104	+\$174	+\$250	+\$348	+\$148
64" H Fabric Monolithic Tile											

# Architecture

Tiles

Planna Storage Benching Multi Access

# System

**PRODUCT CODE**  
**KEY EXAMPLE**

IN6.75MAP30B

**INPL** Inscape System  
Planna

**6.75** 6.75" H

**MAP** Multi access - painted

**30** 30" W

- Use with 3.5" thick panel only
- Paint finish only
- Painted tiles are available in any of Inscape's standard paint colors or a custom color can be accommodated
- Painted tile is magnetic
- Flush bezel color option of black (default), white and gray
- Be sure to confirm crossrail locations will accommodate tile height
- Crossrails can be found in the accessory section of the price list under Panel and Table accessories

	Part number	H	W	Neutral paint/ base price	Accent paint	
	6.75" H Painted Multi Access Tile for use with Planna Storage	<b>INPL6.75MAP30</b>	6.75"	30"	\$104	+\$13
		<b>INPL6.75MAP36</b>	6.75"	36"	\$107	+\$15
		<b>INPL6.75MAP42</b>	6.75"	42"	\$115	+\$15



**Architecture**

Tiles  
Foam Bumper

**System**

The Foam Bumpers are required for the following tiles then they are used directly below a top can on a 3.5" frame:

- 13 1/2"h tiles that are 54" or 60" wide that are NOT Screen, Tackable, Wall Mounted Tackable or Whiteboard require 1 bumper
- 20 1/4"h tiles that are 54" or 60" wide that are NOT Screen, Tackable, Wall Mounted Tackable or Whiteboard require 1 bumper
- Whiteboard tiles 36" wide or wider require 2 bumpers
- 27"h tiles that are 48" wide that are NOT Nuform require 2 bumpers

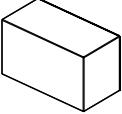
	Part number	H	W	List price
 <p>Foam Bumper for back of select tiles</p>	<b>QSDB</b>	—	—	\$0

# System Technology

**inscape**

work for tomorrow

Inscape System electrical is UL and CSA approved. New York City and Chicago solutions are also available as standard offering. The electrical system features 8 wires and 4 circuits that can be configured in a 2+2 or 3+1 circuit configuration. All electrical components, with the exception of the power feed (which must be connected to the building power supply by a licensed electrician) may be installed by furniture installers, unless otherwise stated by jurisdiction of the installation.

Inscape System electrical components consist of the following: Floor/Wall power in-feed, ceiling power in-feed, chimney feed, power tracks, jumper cables and duplex receptacles. Power components snap into place without the need of tools.

**POWER IN-FEED CONNECTIONS**

Power in-feed connections can be made through a wall, column, or floor connection. Power in-feed connections consist of an 84" long liquid tight cable and a 45" flex cable connected by a 3" metal coupler and elbow joint to sit between bottom rails. The liquid tight portion of the Power in-feed must be connected to the building power supply by an electrician.

If two power feeds are being specified for one cluster of stations, care must be taken not to cross connect the two feeds through jumper cables and power tracks.

New York City has requirements for special power entry assemblies. A qualified electrician is required to hard-wire the **New York City In-feed** from the entry box to the power source. The New York City feed works for side feed, end feed or ceiling feed.

The City of Chicago does not permit the use of pre-wired modular electrical systems. To simplify hardwiring of the Inscape System panel, the **City of Chicago Hold Down Bracket** is available. When requiring power and data in the beltline location, it is required that basic frames be specified with the width specific code (ECHB-BL- ). The beltline location code includes the beltline cover as well as the City of Chicago Hold Down bracket which is based on the width of the frame. When specifying in locations other than at the beltline, an attachment bracket (INECHB) is available. Specify two INECHB for each power entry point, one for the power feed and one for the outlet. (The outlet box is NOT supplied by Inscape). INECHB's are available in packages of 6. **Boxes should be sourced through Ental Industries or J&A Sheet both local Chicago suppliers of electrical junction boxes.**

**NOTE: Panels 30" W will accept one double-sided outlet box. Panels 36" W and wider will accept two boxes. INECHB's may also be specified to mount multi-user termination boxes inside the panel.**

**WIRE DESIGNATION**

**2 + 2 Circuit Configuration**

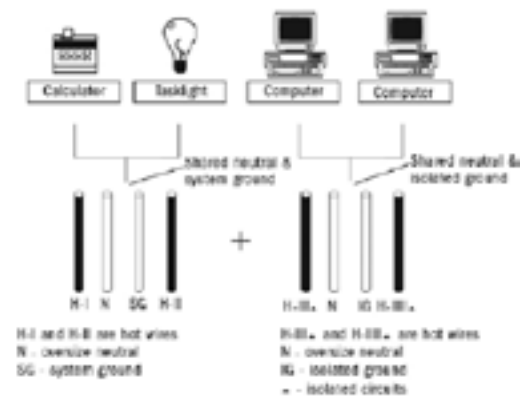

**2+2**

- Circuits #1 and #2 share one oversize neutral and one shared ground to provide convenience power for task lights, calculators, radios etc.
- Circuits #3 and #4 share the other oversize neutral and isolated ground to provide isolated power to computers.

**3 + 1 Circuit Configuration**

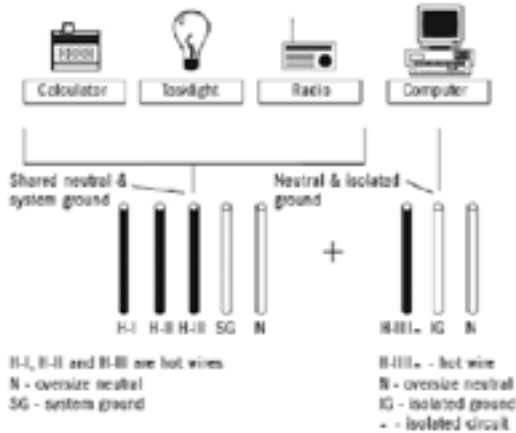

**3+1**

- Circuits #1, #2 and #3 share one oversized neutral and one shared ground to provide convenience power for task lights, calculators, radios etc.
- Circuit #4 uses the other oversized neutral and isolated ground to provide isolated power to computers.

**CEILING POWER AND DATA FEEDS KIT**

Ceiling power and data feeds kit includes a split top trim to facilitate cable entry into the panel, a ceiling grommet, a 16' long electrical cable and power pole featuring a septum to separate power from data cables to avoid electromagnetic interference (EMI). Specify ceiling power pole according to panel width. The ceiling power entry cable must be connected to the building power supply by an electrician. If two power feeds are being specified for one cluster of stations, care must be taken not to cross connect the two feeds through jumper cables and power tracks. The entire power pole accommodates 61 Cat6 and 78 Cat5 cables at a 60% fill capacity if no electrical cable is routed through pole. If electrical is routed within power pole, at a 60% fill capacity, 46 Cat6 and 59 Cat5 cables may be accommodated.



**THE CHIMNEY CEILING FEED**

The chimney ceiling feed carries up to 99 Cat6 or 128 Cat5 cables from the ceiling into the panel at 60% capacity when electrical is routed within chimney feed as well. If only data is being routed through Chimney Feed 147 Cat6 or 189 Cat5 cables may be routed through the chimney feed. The chimney kit consists of an 18" W Basic frame which includes an internal channel, ceiling collar (white only), and top trim. A septum within the chimney feed separates power and data cables. All tiles and vertical end trim must be specified separately. The 16' power entry cable is optional and is specified by the appropriate code.



## POWER TRACKS

Power tracks are specified for frames 30" W and wider. This power track mounts at the beltline location of a 3 1/2" thick Standard frame by clips that are shipped with the frame. The 30" W power track accepts one duplex per side. A power track 36" W and wider accepts two duplexes per side. Power tracks do not include jumper cables. Jumper cables must be specified to carry power from track to track (see Application Guide for length requirements).

## POWER TRACK KITS

Power track kits consist of a power track and clips to attach the power track to a crossrail. The kit allows for power tracks to be mounted in all locations of the 2 3/4" thick panel and in locations other than the beltline location in the 3 1/2" thick standard frames. Jumper cables and receptacles are specified separately. The 30" W Power Track Kit accepts one duplex per side. Power Track Kits which are 36" W and wider accept two duplexes per side. Power Track Kits may be specified below the following; Transaction Tops, Up mount Bins, Stack on Glaze, Add on Glaze and Double Glazed Tiles. Power Track Kits MAY NOT be specified below Twin Bins or Power Poles.

## JUMPER CABLES

Jumper cables by-pass non-powered panels and also facilitates connections from power track to power track. Jumper cables must attach to power tracks only and cannot be attached to adjacent jumper cables or power in-feeds. Product codes indicate the width of the jumper cable which may be cross-referenced in the Inscape System Application Guide. Various widths of jumper cables are available to facilitate various applications and configurations.

*\*See Inscape System Application Guide for details.*

## DUPLEX RECEPTACLES

Duplex receptacles snap into power tracks back-to-back and may be accessed through cutouts in either the electrical cover plate with standard frames or multi-access and communication tiles in all other locations and basic frames. Duplexes are interchangeable amongst the varying power track locations. However, specific duplexes are required for various frame thicknesses and Electrified Storage, and need to be specified accordingly. Specify duplexes according to circuit configuration, 2+2 or 3+1. The IN3D3-\_ duplex is specific to 2+2 wire configurations and the IN3DU3-\_ duplex is specified for 3+1 wire configurations. General rule is no more than 12 receptacles per circuit per power in feed. Duplexes may be specified in black, white (close match to P168 – Glacier White) and gray (close match to P290 – Aluminum Leaf).

Controlled receptacles to satisfy California Title 24 are available. These receptacles control circuits through building switches. When circuits are controlled through building switches, it is required to identify which circuit is controlled to the end user. To identify the receptacles on the controlled circuit, Inscape's controlled receptacles have a power mark (circle with the vertical line). The fit and function of these receptacles are same as the standard receptacle offering only application is in controlled circuits.

USB receptacles are also available. The snap into the standard power track. Each module provides 2 amp output via 2 USB ports and are available for both 2+2 and 3+1 wire configurations. Duplexes may be specified in black, white (close match to P168 – Glacier White) and gray (close match to P290 – Aluminum Leaf.)

## TASK LIGHTS

The LED task light is 20" in length and is silver in color. It is 7.5" W and has light color of cool white; 4,500° - 5,500°. The LED task light may be positioned on an overhead bin, shelf or twin bin. When mounted, because of its height of 7/8" H, it is not as visible as other task lights. This task light is magnetic but can also be mounted with screws if needed.

The Tuck Light comes in three length options; 17", 31" and 44". These options are nominal, see dimension info on pricing chart for actual dimensions. It is an LED fixture that comes stand in silver with black endcaps and frosted lens. This light offers 18-watt wall transformer with 9' black cord. The light output can be customized with the touch-and-hold dimming feature. Each code comes with one light fixture, one on/off/dimmer pack, one 18-watt power supply, magnet or screw mount options and two cord managers.

## DATA COMPONENTS

### DATA HANGER BRACKET

The Data Hanger Bracket provides a place for a voice/data box to be installed within the panel behind the tile (voice/data box not included). The bracket will accommodate up to a 6 outlet faceplate and is packaged in pairs.

### HINGED COVER (INHRC)

The hinged cover (INHRC) snaps into the cutouts which are found in multi access and communication tiles. When data faceplates and receptacles are not required the hinged cover provides a visual and protective cover.

### FIBER OPTIC OUTLET (INCFO)

Fiber optic outlet (INCFO) is specified to be installed in a cutout in a multi access or communication tile. May be specified in black, white (close match to P168 – Glacier White) and gray (close match to P290 – Aluminum Leaf).

### DATA AND COMMUNICATION FACEPLATE (INCDP)

The data and communication faceplate (INCDP) installs in a cutout in a multi access or communication tile where plug and play access is required. The faceplate provides three “slots” where the Category 5 (INCABRJ45), Category 6 (INCABR6J45), and/or Telephone Jacks (INCRJ11) may be inserted. All “openings” need to be filled with data or phone jacks, The Blank Data Plate Insert (INCB) fills in any which are not being used. Data components may be specified in black, white (close match to P168 – Glacier White) and gray (close match to P290 – Aluminum Leaf). Telephone Jacks (INCRJ11) are not available in gray. Data Communication Plates (INCDP) are not currently available in white.

### WORKSURFACE GROMMETS

Worksurface grommets are field installed and instructions are available. Inscape cannot and will not be held responsible for the quality of workmanship executed by any installation firm engaged to provide grommet-cutting services required for the field installation of our grommet sleeve/cap offering.

### CLAMP-ON POWER MODULES

Clamp-on power may be clamped along edge of worksurface for plug and play access to electrical/voice/data. Power Modules plug into the duplexes and attach to 1” and 1 ¼” thick worksurfaces.

The Clamp-On Power Module has a 3 receptacle/1 dual USB port configuration and is available in a black or white finish. It has a 96” long power cord and LED surge protection indication. The mount includes a device holder.

The Clamp-On Power Module with Colored Components comes in many different configurations with receptacles, USB (1 type A and 1 type B) ports and availability lights. Power Modules come in black, white or gray and have colored options for the lid; Black, White, Teal, Red, Purple, Blue, Green, Gray. The availability light is user controlled and requires free software download.

### CABLE HOOKS

Cable Hooks support and segregate data cables. Each frame 37” and higher ships with one cable manager. Cable hooks carry data cables to their termination voice/data point at a multi access or communication tile for plug and play access or to hanger brackets which are located behind the tile.

### WIRE MANAGEMENT CLIPS

Wire management clips are required when power is being routed from a Credenza Storage benching application frame to the worksurface. Where cabling is running from behind a Credenza Storage case, these wire management clips are mounted to the underside of the inside of the case and the wires are cleanly routed to the main surface. These clips come in a package of 10 and are white in color.

### WIRE CASING

Wire casing manages cables and technology from a worksurface to the floor. Casing is 29” long but can be adjustable in length by removing or adding “links”. Casing is available in gray. As standard the wire casing accommodates 28.5” H worksurface heights. The wire casing accommodates 30 Cat5 cables with electrical works at a 60% fill capacity which is recommended. Approximately 36 Cat5 cables may be accommodated in the wire casing at a 60% fill capacity without electrical works.

### POWER BAR

Power bar is a white power bar consisting of 6 outlets and a 10’ cord which may be specified to provide additional outlets. Addition of power bars should be taken into account when determining the amount of power required for a single or a cluster of stations. The power bar may be mounted under the worksurface.

### ELECTRIFIED STORAGE COMPLIMENT TECHNOLOGY COMPONENTS

Electrified storage compliment technology components have been designed to fit within or compliment the Electrified Storage case. These components essentially work the same as the frame components but are specified based on specific lengths in relation to Electrified Storage.

#### ELECTRIFIED STORAGE CABLE CLOSETS

The electrified storage cable closets are designed to facilitate technology entering the Electrified Storage cases if a panel is not present. The cable closet is specified for the end of an Electrified Storage single case or run of cases. The closet is 1 ½" space thick, 18" W and is specified based on the height of the case with which it is mounting to. Technology may enter the cable closet via the floor or ceiling. Specify correct closet for desired application.

When ceiling feed is required, the **Cable Feed Kit** for the cable closet is required to be specified separately based on the ceiling height. Cable closets which attach to the 1 ½" screen are available to allow for technology to enter an Electrified Storage unit when the 1 ½" screen is being utilized which does not carry power. Be sure to specify inline connectors for the connection of this cable closet to the screen. Closets include all hardware to attach to the Electrified Storage case.

**NOTE: Holes are required to be drilled in the case in order to attach cable closet brackets.**



#### ELECTRICAL MODULE SIDE COVER

Electrical module side cover is specified for the end of an Electrified Storage unit to conceal the technology zone when a panel, screen or cable closet is not specified. This is a value engineered solution for the finishing of an Electrified Storage run. This cover may be painted the same colors as the Electrified Storage cases.

#### ELECTRICAL MODULE FRONT COVER

Electrical module front cover come standard with all Electrified Storage base cases; one side with cutout and one side without. When the configuration of an Electrified Storage base unit calls for additional cutouts or no cutouts on the other side of the unit, the appropriate front cover may be specified. The 30" W front cover only includes one cutout.

- Power in-feed connections consist of an 84" long liquid tight cable and a 45" flex cable connected by a 3" metal coupler and elbow joint to sit between bottom rails
- All electrical components are standard 8 wire configuration



	Part number	List price
 <p>Standard Floor/Wall Power In Feed Kits</p>	<b>INEFWK-8</b>	<b>\$361</b>
 <p>New York City Power In Feed Kit</p>	<b>INEFWK-NY-8</b>	<b>\$641</b>



- The ceiling power pole accommodates a maximum ceiling height of 11' when placed atop any systems frame height
- See Inscape System Application Guide for compatibility with ceiling heights
- Power pole kit includes top trim, power pole (exposed height noted below) and electrical power in-feed
- "2F" denotes use with 2 ¾" thick frame  
"3F" denotes use with 3 ½" thick frame

**NOTES**

- Beltline Power Track or Power Track Kit must be located in frame where power pole is entering in order for in-feed to connect

	Part number	H	W	Tapered	Flat	Accent paint	
	Ceiling Power Pole Kit For use with 3 ½" T Frames	<b>INECFK24-8-3F</b>	113"	24"	\$1169	\$1169	+\$120
		<b>INECFK30-8-3F</b>	113"	30"	\$1176	\$1176	+\$120
		<b>INECFK36-8-3F</b>	113"	36"	\$1183	\$1183	+\$121
		<b>INECFK42-8-3F</b>	113"	42"	\$1194	\$1194	+\$123
		<b>INECFK48-8-3F</b>	113"	48"	\$1200	\$1200	+\$123
		<b>INECFK54-8-3F</b>	113"	54"	\$1217	\$1217	+\$125
		<b>INECFK60-8-3F</b>	113"	60"	\$1222	\$1222	+\$125
	Ceiling Power Pole Kit For use with 2 ¾" T Frames	<b>INECFK24-8-2F</b>	113"	24"	—	\$1169	+\$120
		<b>INECFK30-8-2F</b>	113"	30"	—	\$1176	+\$120
		<b>INECFK36-8-2F</b>	113"	36"	—	\$1183	+\$121
		<b>INECFK42-8-2F</b>	113"	42"	—	\$1194	+\$123
		<b>INECFK48-8-2F</b>	113"	48"	—	\$1200	+\$123
		<b>INECFK54-8-2F</b>	113"	54"	—	\$1217	+\$125
		<b>INECFK60-8-2F</b>	113"	60"	—	\$1222	+\$125

- Chimney Feed Kit consists of an 18" W frame and top cap as well as electrical if optioned
- Tiles may span the 18" W Chimney frame along with adjacent frame (see Inscape System Application Guide for acceptable spans)
- "2F" denotes use with 2 ¾" thick frame
- "3F" denotes use with 3 ½" thick frame
- 96" version is a 64" H frame with additional 27" H stack
- 104" version is a 64" H frame with additional 27" and 13.5" H stack

**NOTES**

- Tiles, vertical trim, inline connectors or corner connectors are specified separately
- A Beltline power track or a Power Track Kit must be specified in directly adjacent panel to the Chimney Power Feed Frame
- 96" H Chimney Power Feed Frame to be ordered for ceiling heights of 8' +/-6"
- 104" H Chimney Power Feed Frame to be ordered for ceiling height of 9' +/-6"

		Part number	H	W	Tapered	Flat	Accent paint
i	Chimney Power Feed Frame with Electrical For use with 3 ½" T Frames	<b>INCF1896E-8-3F</b>	96"	18"	\$1737	\$1737	+\$177
		<b>INCF18104E-8-3F</b>	104"	18"	\$2014	\$2014	+\$204
i	Chimney Power Feed Frame without Electrical For use with 3 ½" T Frame	<b>INCF1896-8-3F</b>	96"	18"	\$1691	\$1691	+\$172
		<b>INCF18104-8-3F</b>	104"	18"	\$1967	\$1967	+\$199
i	Chimney Power Feed Frame with Electrical For use with 2 ¾" T Frames	<b>INCF1896E-8-2F</b>	96"	18"	—	\$1737	+\$177
		<b>INCF18104E-8-2F</b>	104"	18"	—	\$2014	+\$204
i	Chimney Power Feed Frame without Electrical For use with 2 ¾" T Frames	<b>INCF1896-8-2F</b>	96"	18"	—	\$1691	+\$172
		<b>INCF18104-8-2F</b>	104"	18"	—	\$1967	+\$199

- City of Chicago bracket for beltline is for 3 ½" thick frame beltline location only
- City of Chicago bracket is compatible with upper deck and base locations in 2 ¾" and 3 ½" thick frames
- "2F" denotes use with 2 ¾" thick frame, "3F" denotes use with 3 ½" thick frame
- Boxes should be sourced through Ental Industries or J&A Sheet both local Chicago suppliers of electrical junction boxes
- Brackets are painted in Eco Black

	Part number	H	W	List price
 City of Chicago Brackets (pkg of 6)	<b>INECHB</b>	—	—	\$90
City of Chicago Bracket for Beltline Location For use with 3 ½" T Standard Frames	<b>INECHB-BL-30-3F</b>	—	30"	\$243
	<b>INECHB-BL-36-3F</b>	—	36"	\$247
	<b>INECHB-BL-42-3F</b>	—	42"	\$249
	<b>INECHB-BL-48-3F</b>	—	48"	\$251
	<b>INECHB-BL-54-3F</b>	—	54"	\$256
	<b>INECHB-BL-60-3F</b>	—	60"	\$263
City of Chicago Bracket for Beltline Location For use with 2 ¾" T Standard Frames	<b>INECHB-BL-30-2F</b>	—	30"	\$243
	<b>INECHB-BL-36-2F</b>	—	36"	\$247
	<b>INECHB-BL-42-2F</b>	—	42"	\$249
	<b>INECHB-BL-48-2F</b>	—	48"	\$251
	<b>INECHB-BL-54-2F</b>	—	54"	\$256
	<b>INECHB-BL-60-2F</b>	—	60"	\$263

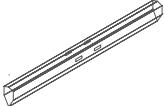
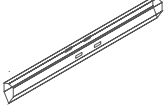

- Add beltline cover kit to a Basic Frame to provide power at beltline location (power track separate)
- Cover kits are painted in Eco Black

		Part number	H	W	List price
	Beltline Cover Kit For use with 3 1/2" T Frames	<b>INBCVRKIT-18-3F</b>	6.75"	18"	\$124
		<b>INBCVRKIT-24-3F</b>	6.75"	24"	\$127
		<b>INBCVRKIT-30-3F</b>	6.75"	30"	\$129
		<b>INBCVRKIT-36-3F</b>	6.75"	36"	\$131
		<b>INBCVRKIT-42-3F</b>	6.75"	42"	\$133
		<b>INBCVRKIT-48-3F</b>	6.75"	48"	\$135
		<b>INBCVRKIT-54-3F</b>	6.75"	54"	\$138
		<b>INBCVRKIT-60-3F</b>	6.75"	60"	\$142
	Beltline Cover Kit For use with 2 3/4" T Frames	<b>INBCVRKIT-18-2F</b>	6.75"	18"	\$124
		<b>INBCVRKIT-24-2F</b>	6.75"	24"	\$127
		<b>INBCVRKIT-30-2F</b>	6.75"	30"	\$129
		<b>INBCVRKIT-36-2F</b>	6.75"	36"	\$131
		<b>INBCVRKIT-42-2F</b>	6.75"	42"	\$133
		<b>INBCVRKIT-48-2F</b>	6.75"	48"	\$135
		<b>INBCVRKIT-54-2F</b>	6.75"	54"	\$138
		<b>INBCVRKIT-60-2F</b>	6.75"	60"	\$142

- Specify power tracks for open beltline location in the 3.5" and 2.75" thick standard frames
- Specify Power Track Kit for all locations other than open beltline in 3.5" and 2.75" thick standard frames, where ever a communication or multi access tile is used
- Receptacles and Jumper Cables (track to track connectors) specified separately

**NOTES**

- Power tracks are required to match the width of the frame it is being installed in
- Power Track Kits may be specified below the following; Transaction Tops, Up mount Bins, Stack on Glaze, Add on Glaze and Double Glazed Tiles
- Power Track Kits MAY NOT be specified below Twin Bins or Power Poles

		Part number	W	List price
	Power Track For use with standard frame at beltline only	<b>INETP30-8</b>	30"	\$144
		<b>INETP36-8</b>	36"	\$160
		<b>INETP42-8</b>	42"	\$171
		<b>INETP48-8</b>	48"	\$182
		<b>INETP54-8</b>	54"	\$195
		<b>INETP60-8</b>	60"	\$204
	Power Track Kit For use in all locations on basic frame	<b>INRUDKIT-30-8</b>	30"	\$185
		<b>INRUDKIT-36-8</b>	36"	\$201
		<b>INRUDKIT-42-8</b>	42"	\$219
		<b>INRUDKIT-48-8</b>	48"	\$238
		<b>INRUDKIT-54-8</b>	54"	\$253
		<b>INRUDKIT-60-8</b>	60"	\$273
	Electrified Twin-Bin Power Track	<b>INETPTWB-8</b>	8"	\$88

- Jumper Cables do not connect together nor do they attach to power in feeds
- See Inscape System Application Guide for length requirements for varying panel configurations
- 24" and 25" W jumper cables are made of a black flexible mesh material
- 28" W and larger jumper cables are made of a more rigid metal Conduit material

	Part number	W	List price
 <p>Jumper Cables</p>	<b>INETC24-8</b>	24"	\$72
	<b>INETC25-8</b>	25"	\$72
	<b>INETC28-8</b>	28"	\$72
	<b>INETC31-8</b>	31"	\$74
	<b>INETC44-8</b>	44"	\$79
	<b>INETC53-8</b>	53"	\$88
	<b>INETC64-8</b>	64"	\$104
	<b>INETC88-8</b>	88"	\$135
	<b>INETC104-8</b>	104"	\$156
	<b>INETC122-8</b>	122"	\$192
	<b>INETC141-8</b>	141"	\$194
	<b>INETC158-8</b>	158"	\$212
	<b>INETC182-8</b>	182"	\$243







- Receptacles are available in color options of black (default), white and gray
- White close match to 168 Glacier White and Gray close match to 290 – Aluminum Leaf
- Receptacles are specific for frame thickness and location in which they are being specified
- The circuit 3 receptacle requires 2+2 or 3+1 wire designation (“U” in the code signifies 3+1 compatibility)
- The “UD” receptacles are to be specified in conjunction with the Electrified Twin Bin
- Controlled receptacles satisfy California Title 24 and are indicated with a “power mark” which is represented buy a circle with a line

**NOTES**



In order to get a total cost on products when upcharges are present take the list price of the product number and add the upcharge cost shown to the list price.

For example:

Product IN3D1-8 in Gray would be \$27 +\$11

	Part number	Black/ base price	White	Gray	
	Receptacle for open Beltline	<b>IN3D1-8</b>	\$27	+\$11	+\$11
	For use in 3 1/2" and 2 3/4" frames	<b>IN3D2-8</b>	\$27	+\$11	+\$11
		<b>IN3D3-8</b>	\$27	+\$11	+\$11
		<b>IN3D3U-8</b>	\$27	+\$11	+\$11
		<b>IN3D4-8</b>	\$27	+\$11	+\$11
	Receptacle for cutout tiles application in 3 1/2" frames	<b>IN3D1-UD-8</b>	\$27	+\$11	+\$11
		<b>IN3D2-UD-8</b>	\$27	+\$11	+\$11
		<b>IN3D3-UD-8</b>	\$27	+\$11	+\$11
		<b>IN3D3U-UD-8</b>	\$27	+\$11	+\$11
		<b>IN3D4-UD-8</b>	\$27	+\$11	+\$11
	Receptacle for cutout tiles application in 2 3/4" frames	<b>IN2D1-8</b>	\$27	+\$11	+\$11
		<b>IN2D2-8</b>	\$27	+\$11	+\$11
		<b>IN2D3-8</b>	\$27	+\$11	+\$11
		<b>IN2D3U-8</b>	\$27	+\$11	+\$11
		<b>IN2D4-8</b>	\$27	+\$11	+\$11
	Controlled Receptacle for open Beltline	<b>IN3D1-8C</b>	\$32	+\$11	+\$11
	For use in 3 1/2" and 2 3/4" frames	<b>IN3D2-8C</b>	\$32	+\$11	+\$11
		<b>IN3D3-8C</b>	\$32	+\$11	+\$11
		<b>IN3D3U-8C</b>	\$32	+\$11	+\$11
		<b>IN3D4-8C</b>	\$32	+\$11	+\$11
	Controlled Receptacle for cutout tiles application in 3 1/2" frames	<b>IN3D1-UD-8C</b>	\$32	+\$11	+\$11
		<b>IN3D2-UD-8C</b>	\$32	+\$11	+\$11
		<b>IN3D3-UD-8C</b>	\$32	+\$11	+\$11
		<b>IN3D3U-UD-8C</b>	\$32	+\$11	+\$11
		<b>IN3D4-UD-8C</b>	\$32	+\$11	+\$11
	Controlled Receptacle for cutout tiles application in 2 3/4" frames	<b>IN2D1-8C</b>	\$32	+\$11	+\$11
		<b>IN2D2-8C</b>	\$32	+\$11	+\$11
		<b>IN2D3-8C</b>	\$32	+\$11	+\$11
		<b>IN2D3U-8C</b>	\$32	+\$11	+\$11
		<b>IN2D4-8C</b>	\$32	+\$11	+\$11

- USB power modules are available in color options of black (default), white and gray
- White close match to 168 Glacier White and Gray close match to 290 – Aluminum Leaf
- USB power modules are specific for frame thickness and location in which they are being specified
- The circuit 3 USB power modules requires 2+2 or 3+1 wire designation (“U” in the code signifies 3+1 compatibility)
- The “UD” USB power modules are to be specified in conjunction with the Electrified Twin Bin

		Part number	List price
 <p>USB Charging Module</p>	USB outlet For use with 2 ¾” T cut out tile	<b>IN2USB1-8</b>	\$166
		<b>IN2USB2-8</b>	\$166
		<b>IN2USB3-8</b>	\$166
		<b>IN2USB3U-8</b>	\$166
		<b>IN2USB4-8</b>	\$166
 <p>USB Charging Module</p>	USB outlet For use with 3 ½” T cut out tile	<b>IN3USB1-UD-8</b>	\$168
		<b>IN3USB2-UD-8</b>	\$168
		<b>IN3USB3-UD-8</b>	\$168
		<b>IN3USB3U-UD-8</b>	\$168
		<b>IN3USB4-UD-8</b>	\$168
 <p>USB Charging Module</p>	USB outlet For use in open beltline location	<b>IN3USB1-8</b>	\$164
		<b>IN3USB2-8</b>	\$164
		<b>IN3USB3-8</b>	\$164
		<b>IN3USB3U-8</b>	\$164
		<b>IN3USB4-8</b>	\$164



- Task Lights mount to the underside of Overhead Bins and Shelves
- Task Lights can be mounted either with screws or magnetically
- A power track must be specified in frame to connect task light
- The LED Magnetic Task Light is magnetic and fits below a Twin Bin and other Overhead Storage
- The Tuck Light is silver with black endcaps and frosted lens

	Part number	H	W	Wt (lbs)	List price
 LED Magnetic Task Light (silver)	<b>INMAGTL</b>	7/8"	20"	1	<b>\$416</b>

	Part number	H	W	D	List price
 Tuck Light	<b>INTL-17</b>	1/2"	18.6"	1.18"	<b>\$265</b>
	<b>INTL-31</b>	1/2"	32.6"	1.18"	<b>\$299</b>
	<b>INTL-44</b>	1/2"	45.6"	1.18"	<b>\$339</b>

- The Hinged Cover is a plastic cover that acts as a hinged door to allow access to the cables if needed. Available in color options of black (default), white and gray
- White close match to 168 Glacier White and Gray close match to 290 Aluminum Leaf
- Data hanger bracket is paint Eco Black and allows for industry standard face data plate mount



**NOTES**

Data cannot be installed directly back to back in a 2 ¾" thick frame application







In order to get a total cost on products when upcharges are present take the list price of the product number and add the upcharge cost shown to the list price.

For example:

Product INHRC in Gray would be \$22 +\$11

	Part number	Wt (lbs)	Black/ base price	White	Gray
 <p>Data Outlet Hanger Brackets (pair)</p>	<b>INDPMT-W</b>	2	\$49	—	—
 <p>Hinged Cover for Tiles with Cutouts</p>	<b>INHRC</b>	—	\$22	+\$11	+\$11

- Grommets must be field installed
- Round Grommet = 2" diameter
- Rectangular Grommet = 3" x 5.25"
- Power Modules mount to the back edge of a surface and are accessible by the user above the surface
- Power Modules plug into the duplexes
- The Clamp-On Power Module is available in a black or white finish. It has a 96" long power cord and LED surge protection indication. It attaches to 1" and 1 ¼" thick worksurfaces and the mount includes a device holder.
- The Clamp-On Power Module with Colored Components comes in many different configurations with receptacles, USB (1 type A and 1 type B) ports and availability lights. Power Modules come in black, white or gray and have colored options for the lid; Black, White, Teal, Red, Purple, Blue, Green, Gray. The availability light is user controlled and requires free software download.
- Flip-up Power & Data Module is finished with a clear anodized aluminum with white inserts and a 72" long power cord
- All electrical components on this page are field installed









	Part number	Dimensions	Black/ base price	White	Silver	Stainless steel
 <p>Grommet Sleeve &amp; Cover Kit</p>	<b>PLNGRKIT</b>	5 ¼"	\$208	—	—	+\$85
 <p>Worksurface Grommet-PVC Sleeve &amp; CAP</p>	<b>GROMMET-WS</b>	—	\$18	—	—	—
	Part number					List price
 <p>Clamp-On Power Module 3 receptacles/1 dual USB port</p>	<b>INPMOD-3P1U</b>					\$173
 <p>Clamp-On Power Module with Colored Components 2 Ports: 1 receptacle + 1 USB AC</p>	<b>INBPMOD-1P1U</b>					\$437
 <p>Clamp-On Power Module with Colored Components 4 Ports: 2 receptacles + 1 USB AC + 1 open data port data not provided</p>	<b>INBPMOD-2P1U1O</b>					\$548
 <p>Clamp-On Power Module with Colored Components 4 Ports: 2 receptacles + 1 USB AC + 1 availability light</p>	<b>INBPMOD-2P1U1L</b>					\$867

# Technology

Clamp On Power & Data Modules

# System

- One cable hook is included with each standard frame
- Wire Casing (INFWC) is 29" long and allows for electrical and data cables to be brought neatly from floor into a table – available in gray only, works with 28.5" worksurface heights
- Power bar available in black only
- Cable Management Tray (INCMTXX) is available in two lengths, painted Eco Black and includes mounting hardware
- Wire Management clips are white and attach by double sided tape which is included

		Part number	W	Wt (lbs)	List price
	Flip-up Power & Data Module 2 outlets + 1 dual USB + 1 data finished in aluminium with white insert	<b>PVDMODFL</b>			\$902
	Extension Cord for Recessed Duplexes	<b>INEXTCORD-1</b>	12"	—	\$72
	Cable Hooks	<b>INEPWMH</b>	—	0.1	\$18
	Wire Management Clip (pkg of 10)	<b>INWMCLIP</b>	—	—	\$30
	Wire Casing (Gray color)	<b>INFWC</b>	—	—	\$130
	Power Bar (6 outlets, 10' cord)	<b>INPBAR</b>	—	—	\$53
	Cable Management Tray	<b>INCMT18</b>	18"	—	\$36
		<b>INCMT30</b>	30"	—	\$47
	Wire mesh cable tray (silver)	<b>INWMTRAY</b>	—	—	\$133

**System**  
Worksurfaces  
& Supports

**inscape**

work for tomorrow

# Worksurfaces & Supports

Panel Mounted Worksurfaces  
General Information

# System

Depth dimension is nominal. Depths are 1" less than stated to provide a 1" gap between the worksurface and panel to facilitate wire management.

True sized worksurfaces are actual size for both the depth and the width.

## IMPERIAL TO METRIC CONVERSIONS

Inches	mm
18"	457
24"	610
30"	762
36"	914
42"	1067
48"	1219
54"	1372
60"	1524
66"	1676
72"	1829
78"	1981
84"	2134
90"	2286
96"	2438

## ELECTRIFIED STORAGE WORKSURFACES

Electrified storage worksurface lengths are true size to what is printed in the price list and are 1" less in length than a module line (panel). This allows for a 1" gap between the Electrified Storage unit and the end of the worksurface facilitating wire management and space for the Electrified Storage worksurface support bracket. This 1" less in length also allows the worksurface to line up on-module with a panel. Optional pencil groove is available.

## NUFORM CLASSIC AND NUFORM SELECT WORKSURFACES

The Nuform top is a thermo-formable polymer based sheet continuously bonded to a 1/4" or 1" thick MDF substrate. The polymer sheet is surface coated with a scratch resistant film. Colors are homogenous throughout the film thickness. Top and edge are one continuous surface with no edge seams. The underside of the top is finished in a low pressure melamine. Nuform tops have the option of a pencil groove running across the width of the worksurface as standard and depth for conference tables. Two price options are available - Nuform Classic and Nuform Select.

Limitations exist with the F09, F38, F40, F42, F43, F45, F46, F47, F48, F49, F50, F51, F57, F58 & F59 Nuforms due to the directional pattern. 48"w standard and split corners are not possible for the above referenced Nuform.

## EDGE DETAILED - NUFORM CLASSIC & NUFORM SELECT

1 1/4" Straight Edge



1" Straight Edge



1 1/4" Tapered Edge



1" Tapered Edge



Top and edge are one continuous surface with no edge seams.

## LAMINATE WORKSURFACES

Plastic laminate is laminated to 1.25" thick particle-board. The underside of the worksurface is finished with a man-made, wood-fiber veneer backer. Worksurfaces specified with a plastic laminate finish include a 2mm edge banding in a coordinating color. Plastic laminate tops do not include a pencil groove.

All worksurfaces default to 1.25" thick, Straight edge. Pencil Groove is only available on Nuform.

## EDGE DETAIL - LAMINATE

Straight Edge



**Load capacity for freestanding and panel mounted worksurfaces is 4.5lbs per linear inch.**

## Worksurfaces & Supports

Panel Mounted Worksurfaces  
General Information

# System

### GRAIN DIRECTION

Grain direction on woodgrain Nuform worksurfaces is as denoted below.

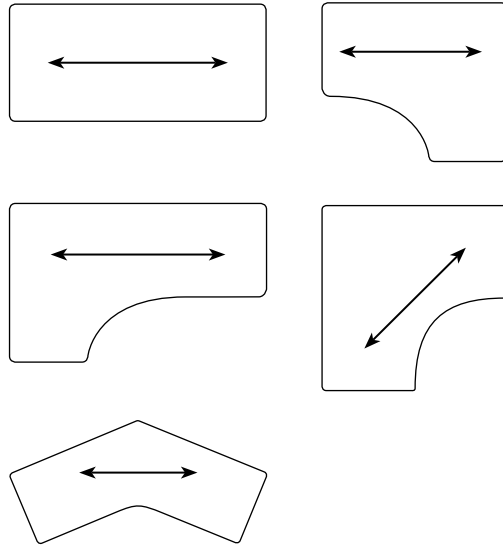

### ADJUSTABLE HEIGHT WORKSURFACES

Adjustable height worksurfaces are available in a panel mounted version which mounts on-module to the Inscape System frame. Worksurfaces provide gas cylinder height adjustment ranging from 28.5" to 49.5" with a lift capacity and calibration of a recommended 25lbs (not including the worksurface). Worksurfaces structured on the height adjustable mechanism are 1" less in stated width in the price list, and are meant to be installed on center to the base allowing for a gap between adjacent surfaces to eliminate pinch points. The base mechanism of the worksurface is available in gray only. See the Inscape System Application Guide for application notes and restrictions.

# Worksurfaces & Supports

## Panel Mounted Worksurfaces

### Rectangular Tops

# System

#### PRODUCT CODE KEY EXAMPLE

INW2024

<b>INW</b>	Inscape System worksurface
<b>20</b>	20" D
<b>18</b>	24" W

- Depth dimension is nominal. Depths are 1" less than stated to provide a 1" gap between the worksurface and panel to facilitate wire management.
- When manually specifying worksurface in laminate, add suffix "-S" to the code
- Optional pencil groove with Nuform
- To manually specify Nuform worksurfaces; begin with the desired thickness then build up options
- 20" deep tops should not be specified with cantilever brackets as mid span support
- 1" thick worksurfaces are not available in laminate
- Stretcher bars are required to be specified with worksurfaces 54" and wider which do have any mid support- ensure not to interfere with support brackets, cable trays or other work tools



#### NOTES

In order to get a total cost on products when an upcharge or downcharge is present you take the list price of the product number and add the upcharge or deduct the downcharge cost shown to the list price.

For example:

Product INW2024 in Nuform Select with a tapered edge would be \$237 +\$29 +\$17

Product INW2024 in Nuform Select with a 1" straight edge would be \$237 +\$29 -\$27

	Part number	W	D	1 1/4" straight edge Nuform classic/ laminate/base price	Nuform select	Nuform tapered edge	Nuform 1" straight edge	Grade 1 laminate 1 1/4" straight edge only
 <p>20" D Rectangular Top</p>	<b>INW2024</b>	24"	20"	\$237	+\$29	+\$17	-\$27	+\$77
	<b>INW2030</b>	30"	20"	\$255	+\$31	+\$20	-\$30	+\$85
	<b>INW2036</b>	36"	20"	\$289	+\$33	+\$20	-\$32	+\$94
	<b>INW2042</b>	42"	20"	\$304	+\$33	+\$21	-\$32	+\$99
	<b>INW2048</b>	48"	20"	\$347	+\$37	+\$23	-\$36	+\$112
	<b>INW2054</b>	54"	20"	\$388	+\$47	+\$29	-\$39	+\$126
	<b>INW2060</b>	60"	20"	\$432	+\$51	+\$31	-\$46	+\$140
	<b>INW2066</b>	66"	20"	\$474	+\$53	+\$33	-\$50	+\$153
	<b>INW2072</b>	72"	20"	\$518	+\$59	+\$34	-\$52	+\$168
	<b>INW2078</b>	78"	20"	\$562	+\$64	+\$36	-\$58	+\$181
	<b>INW2084</b>	84"	20"	\$692	+\$71	+\$37	-\$127	+\$222
	<b>INW2090</b>	90"	20"	\$734	+\$77	+\$44	-\$108	+\$237
<b>INW2096</b>	96"	20"	\$781	+\$87	+\$46	-\$102	+\$251	
 <p>24" D Rectangular Top</p>	<b>INW2424</b>	24"	24"	\$292	+\$33	+\$17	-\$32	+\$96
	<b>INW2430</b>	30"	24"	\$318	+\$35	+\$20	-\$34	+\$103
	<b>INW2436</b>	36"	24"	\$360	+\$39	+\$20	-\$37	+\$118
	<b>INW2442</b>	42"	24"	\$377	+\$42	+\$21	-\$39	+\$123
	<b>INW2448</b>	48"	24"	\$432	+\$47	+\$23	-\$46	+\$140
	<b>INW2454</b>	54"	24"	\$485	+\$53	+\$29	-\$52	+\$158
	<b>INW2460</b>	60"	24"	\$538	+\$57	+\$31	-\$56	+\$173
	<b>INW2466</b>	66"	24"	\$590	+\$61	+\$33	-\$60	+\$191
	<b>INW2472</b>	72"	24"	\$646	+\$67	+\$34	-\$66	+\$209
	<b>INW2478</b>	78"	24"	\$701	+\$73	+\$36	-\$72	+\$226
	<b>INW2484</b>	84"	24"	\$755	+\$79	+\$37	-\$77	+\$243
	<b>INW2490</b>	90"	24"	\$812	+\$87	+\$44	-\$86	+\$262
<b>INW2496</b>	96"	24"	\$867	+\$90	+\$46	-\$89	+\$279	



# Worksurfaces & Supports

Panel Mounted Worksurfaces  
Rectangular Tops

# System

## PRODUCT CODE KEY EXAMPLE

INW2024

<b>INW</b>	Inscape System worksurface
<b>20</b>	20" D
<b>18</b>	24" W

- Depth dimension is nominal. Depths are 1" less than stated to provide a 1" gap between the worksurface and panel to facilitate wire management.
- When manually specifying worksurface in laminate, add suffix "-S" to the code
- Optional pencil groove with Nuform
- To manually specify Nuform worksurfaces; begin with the desired thickness then build up options
- 1" thick worksurfaces are not available in laminate
- Stretcher bars are required to be specified with worksurfaces 54" and wider which do have any mid support- ensure not to interfere with support brackets, cable trays or other work tools



## NOTES

In order to get a total cost on products when an upcharge or downcharge is present you take the list price of the product number and add the upcharge or deduct the downcharge cost shown to the list price.

For example:

Product INW3024 in Nuform Select with a tapered edge would be \$373 +\$42 +\$21

Product INW3024 in Nuform Select with a 1" straight edge would be \$373 +\$42 -\$39

	Part number	W	D	1 1/4" straight edge Nuform classic/ laminate/base price	Nuform select	Nuform tapered edge	Nuform 1" straight edge	Grade 1 laminate 1 1/4" straight edge only
 <p>30" D Rectangular Top</p>	<b>INW3024</b>	24"	30"	\$373	+\$42	+\$21	-\$39	+\$121
	<b>INW3030</b>	30"	30"	\$393	+\$45	+\$25	-\$44	+\$128
	<b>INW3036</b>	36"	30"	\$448	+\$48	+\$26	-\$47	+\$144
	<b>INW3042</b>	42"	30"	\$472	+\$51	+\$27	-\$50	+\$153
	<b>INW3048</b>	48"	30"	\$538	+\$57	+\$31	-\$56	+\$173
	<b>INW3054</b>	54"	30"	\$604	+\$63	+\$32	-\$61	+\$196
	<b>INW3060</b>	60"	30"	\$674	+\$70	+\$35	-\$69	+\$216
	<b>INW3066</b>	66"	30"	\$720	+\$74	+\$39	-\$73	+\$233
	<b>INW3072</b>	72"	30"	\$807	+\$85	+\$42	-\$84	+\$259
	<b>INW3078</b>	78"	30"	\$895	+\$91	+\$47	-\$90	+\$288
	<b>INW3084</b>	84"	30"	\$980	+\$102	+\$52	-\$100	+\$316
	<b>INW3090</b>	90"	30"	\$1066	+\$111	+\$57	-\$106	+\$343
<b>INW3096</b>	96"	30"	\$1156	+\$120	+\$60	-\$118	+\$371	
 <p>36" D Rectangular Top</p>	<b>INW3624</b>	24"	36"	\$431	+\$48	+\$67	-\$48	+\$139
	<b>INW3630</b>	30"	36"	\$456	+\$51	+\$72	-\$51	+\$147
	<b>INW3636</b>	36"	36"	\$519	+\$56	+\$83	-\$56	+\$168
	<b>INW3642</b>	42"	36"	\$548	+\$57	+\$86	-\$57	+\$177
	<b>INW3648</b>	48"	36"	\$621	+\$66	+\$97	-\$70	+\$201
	<b>INW3654</b>	54"	36"	\$699	+\$73	+\$105	-\$70	+\$225
	<b>INW3660</b>	60"	36"	\$783	+\$84	+\$118	-\$84	+\$252
	<b>INW3666</b>	66"	36"	\$830	+\$87	+\$124	-\$87	+\$267
	<b>INW3672</b>	72"	36"	\$935	+\$94	+\$129	-\$93	+\$301

# Worksurfaces & Supports

Panel Mounted Worksurfaces  
90° Rectangular Tops

# System

## PRODUCT CODE KEY EXAMPLE

INSWW2423

<b>IN</b>	Inscape System
<b>SWW</b>	90° worksurface
<b>24</b>	24" D
<b>23</b>	23" W

- 90° worksurfaces are 1" less in length than standard worksurfaces to accommodate a wire management gap all the way around an L shaped workstation
- When manually specifying worksurface in laminate, add suffix "-S" to the code
- Optional pencil groove with Nuform
- To manually specify Nuform worksurfaces; begin with the desired thickness then build up options
- 1" thick worksurfaces are not available in laminate
- Stretcher bars are required to be specified with worksurfaces 54" and wider which do have any mid support – ensure not to interfere with support brackets, cable trays or other work tools



## NOTES

In order to get a total cost on products when an upcharge or downcharge is present you take the list price of the product number and add the upcharge or deduct the downcharge cost shown to the list price.

For example:

Product INSWW2423 in Nuform Select with a tapered edge would be \$292 +\$33 +\$17

Product INSWW2423 in Nuform Select with a 1" straight edge would be \$292 +\$33 -\$32

	Part number	W	D	1 1/4" straight edge Nuform classic/ laminate/base price	Nuform select	Nuform tapered edge	Nuform 1" straight edge	Grade 1 laminate 1 1/4" straight edge only
 <p>24" D 90° Rectangular Top</p>	<b>INSWW2423</b>	23"	24"	\$292	+\$33	+\$17	-\$32	+\$96
	<b>INSWW2429</b>	29"	24"	\$318	+\$35	+\$20	-\$34	+\$103
	<b>INSWW2435</b>	35"	24"	\$360	+\$39	+\$20	-\$37	+\$118
	<b>INSWW2441</b>	41"	24"	\$377	+\$42	+\$21	-\$39	+\$123
	<b>INSWW2447</b>	47"	24"	\$432	+\$47	+\$23	-\$46	+\$140
	<b>INSWW2453</b>	53"	24"	\$485	+\$53	+\$29	-\$52	+\$158
	<b>INSWW2459</b>	59"	24"	\$538	+\$57	+\$31	-\$56	+\$173
	<b>INSWW2465</b>	65"	24"	\$590	+\$61	+\$33	-\$60	+\$191
	<b>INSWW2471</b>	71"	24"	\$646	+\$67	+\$34	-\$66	+\$209
	<b>INSWW2477</b>	77"	24"	\$701	+\$73	+\$36	-\$72	+\$226
	<b>INSWW2483</b>	83"	24"	\$755	+\$79	+\$37	-\$77	+\$243
	<b>INSWW2489</b>	89"	24"	\$812	+\$87	+\$44	-\$86	+\$262
<b>INSWW2495</b>	95"	24"	\$867	+\$90	+\$46	-\$89	+\$279	
 <p>30" D 90° Rectangular Top</p>	<b>INSWW3023</b>	23"	30"	\$373	+\$42	+\$21	-\$39	+\$121
	<b>INSWW3029</b>	29"	30"	\$393	+\$45	+\$25	-\$44	+\$128
	<b>INSWW3035</b>	35"	30"	\$448	+\$48	+\$26	-\$47	+\$144
	<b>INSWW3041</b>	41"	30"	\$472	+\$51	+\$27	-\$50	+\$153
	<b>INSWW3047</b>	47"	30"	\$538	+\$57	+\$31	-\$56	+\$173
	<b>INSWW3053</b>	53"	30"	\$604	+\$63	+\$32	-\$61	+\$196
	<b>INSWW3059</b>	59"	30"	\$674	+\$70	+\$35	-\$69	+\$216
	<b>INSWW3065</b>	65"	30"	\$720	+\$74	+\$39	-\$73	+\$233
	<b>INSWW3071</b>	71"	30"	\$807	+\$85	+\$42	-\$84	+\$259
	<b>INSWW3077</b>	77"	30"	\$895	+\$91	+\$47	-\$90	+\$288
	<b>INSWW3083</b>	83"	30"	\$980	+\$102	+\$52	-\$100	+\$316
	<b>INSWW3089</b>	89"	30"	\$1066	+\$111	+\$57	-\$106	+\$343
<b>INSWW3095</b>	95"	30"	\$1156	+\$120	+\$60	-\$118	+\$371	
 <p>36" D 90° Rectangular Top</p>	<b>INSWW3623</b>	23"	36"	\$431	+\$48	+\$67	-\$48	+\$139
	<b>INSWW3629</b>	29"	36"	\$456	+\$51	+\$72	-\$51	+\$147
	<b>INSWW3635</b>	35"	36"	\$519	+\$56	+\$83	-\$56	+\$168
	<b>INSWW3641</b>	41"	36"	\$548	+\$57	+\$86	-\$57	+\$177
	<b>INSWW3647</b>	47"	36"	\$621	+\$66	+\$97	-\$70	+\$201
	<b>INSWW3653</b>	53"	36"	\$699	+\$73	+\$105	-\$73	+\$225
	<b>INSWW3659</b>	59"	36"	\$783	+\$84	+\$118	-\$84	+\$252
	<b>INSWW3665</b>	65"	36"	\$830	+\$87	+\$124	-\$87	+\$267
	<b>INSWW3671</b>	71"	36"	\$935	+\$94	+\$129	-\$93	+\$301

# Worksurfaces & Supports

Panel Mounted Worksurfaces  
True Sized Rectangular Tops

# System

## PRODUCT CODE KEY EXAMPLE

INSTW1830

**INSTW** Inscape System  
worksurface

**18** 18" D

**30** 30" W

- These worksurfaces are true sized for both depth & width
- When manually specifying worksurface in laminate, add suffix “-S” to the code
- To manually specify Nuform worksurfaces; begin with the desired thickness then build up options
- 18" deep tops should not be specified with cantilever brackets as mid span support
- 1" thick worksurfaces are not available in laminate
- Stretcher bars are required to be specified with worksurfaces 54" and wider which do have any mid support – ensure not to interfere with support brackets, cable trays or other work tools



## NOTES

In order to get a total cost on products when an upcharge or downcharge is present you take the list price of the product number and add the upcharge or deduct the downcharge cost shown to the list price.

For example:

Product INSTW1830 in Nuform Select would be \$222 +\$27

Product INSTW1830 in Nuform Select with a 1" straight edge would be \$222 +\$27 -\$25

	Part number	W	D	1 1/4" straight edge Nuform classic/laminate/base price	Nuform select	Nuform 1" straight edge	Grade 1 laminate 1 1/4" straight edge only
 <p>18" D True Sized Rectangular Top</p>	<b>INSTW1830</b>	30"	18"	\$222	+\$27	-\$25	+\$72
	<b>INSTW1836</b>	36"	18"	\$248	+\$31	-\$29	+\$80
	<b>INSTW1842</b>	42"	18"	\$276	+\$34	-\$32	+\$89
	<b>INSTW1848</b>	48"	18"	\$302	+\$37	-\$34	+\$98
	<b>INSTW1854</b>	54"	18"	\$329	+\$40	-\$37	+\$106
	<b>INSTW1860</b>	60"	18"	\$400	+\$49	-\$45	+\$129
	<b>INSTW1866</b>	66"	18"	\$417	+\$51	-\$47	+\$134
	<b>INSTW1872</b>	72"	18"	\$467	+\$57	-\$52	+\$151
 <p>24" D True Sized Rectangular Top</p>	<b>INSTW2430</b>	30"	24"	\$318	+\$36	-\$35	+\$103
	<b>INSTW2436</b>	36"	24"	\$360	+\$39	-\$37	+\$116
	<b>INSTW2442</b>	42"	24"	\$377	+\$42	-\$40	+\$121
	<b>INSTW2448</b>	48"	24"	\$432	+\$47	-\$46	+\$139
	<b>INSTW2454</b>	54"	24"	\$485	+\$53	-\$53	+\$156
	<b>INSTW2460</b>	60"	24"	\$538	+\$57	-\$56	+\$173
	<b>INSTW2466</b>	66"	24"	\$590	+\$61	-\$61	+\$189
	<b>INSTW2472</b>	72"	24"	\$646	+\$67	-\$66	+\$208

# Worksurfaces & Supports

Panel Mounted Worksurfaces

Reducing Tops

# System

## PRODUCT CODE KEY EXAMPLE

INRDL302430

<b>IN</b>	Inscape System
<b>RD</b>	reducing top
<b>L</b>	left hand
<b>3024</b>	30 – 24" D
<b>30</b>	30" W

- Depth dimension is nominal. Depths are 1" less than stated to provide a 1" gap between the worksurface and panel to facilitate wire management.
- Reducing tops are available in Nuform finish only
- Optional pencil groove with Nuform
- To manually specify Nuform worksurfaces; begin with the desired thickness then build up options
- 1" thick worksurfaces are not available in laminate
- Stretcher bars are required to be specified with worksurfaces 54" and wider which do have any mid support– ensure not to interfere with support brackets, cable trays or other work tools



## NOTES

In order to get a total cost on products when an upcharge or downcharge is present you take the list price of the product number and add the upcharge or deduct the downcharge cost shown to the list price.

For example:

Product INRDL302430 in Nuform Select with a tapered edge would be \$391 +\$37 +\$22

Product INRDL302430 in Nuform Select with a 1" straight edge would be \$391 +\$37 -\$36

	Part number	W	D	1 1/4" straight edge Nuform classic/ laminate/base price	Nuform select	Nuform tapered edge	Nuform 1" straight edge
 <p>Left Hand Reducing Top</p>	<b>INRDL302430</b>	30"	30-24"	\$391	+\$37	+\$22	-\$36
	<b>INRDL302436</b>	36"	30-24"	\$448	+\$46	+\$25	-\$45
	<b>INRDL302442</b>	42"	30-24"	\$472	+\$47	+\$26	-\$46
	<b>INRDL302448</b>	48"	30-24"	\$538	+\$52	+\$30	-\$51
	<b>INRDL302454</b>	54"	30-24"	\$604	+\$57	+\$32	-\$56
	<b>INRDL302460</b>	60"	30-24"	\$674	+\$63	+\$35	-\$61
	<b>INRDL302466</b>	66"	30-24"	\$720	+\$67	+\$37	-\$66
	<b>INRDL302472</b>	72"	30-24"	\$803	+\$74	+\$43	-\$73
	<b>INRDL302478</b>	78"	30-24"	\$844	+\$79	+\$44	-\$74
	<b>INRDL302484</b>	84"	30-24"	\$884	+\$87	+\$46	-\$86
	<b>INRDL302490</b>	90"	30-24"	\$923	+\$86	+\$52	-\$86
<b>INRDL302496</b>	96"	30-24"	\$974	+\$94	+\$53	-\$93	
 <p>Right Hand Reducing Top</p>	<b>INRDR243030</b>	30"	24-30"	\$391	+\$37	+\$22	-\$36
	<b>INRDR243036</b>	36"	24-30"	\$448	+\$46	+\$25	-\$45
	<b>INRDR243042</b>	42"	24-30"	\$472	+\$47	+\$26	-\$46
	<b>INRDR243048</b>	48"	24-30"	\$538	+\$52	+\$30	-\$51
	<b>INRDR243054</b>	54"	24-30"	\$604	+\$57	+\$32	-\$56
	<b>INRDR243060</b>	60"	24-30"	\$674	+\$63	+\$35	-\$61
	<b>INRDR243066</b>	66"	24-30"	\$720	+\$67	+\$37	-\$66
	<b>INRDR243072</b>	72"	24-30"	\$803	+\$74	+\$43	-\$73
	<b>INRDR243078</b>	78"	24-30"	\$844	+\$79	+\$44	-\$74
	<b>INRDR243084</b>	84"	24-30"	\$884	+\$87	+\$46	-\$86
	<b>INRDR243090</b>	90"	24-30"	\$923	+\$86	+\$52	-\$86
<b>INRDR243096</b>	96"	24-30"	\$974	+\$94	+\$53	-\$93	

# Worksurfaces & Supports

Panel Mounted Worksurfaces  
Saddle Tops

# System

## PRODUCT CODE KEY EXAMPLE

INSD3048

<b>IN</b>	Inscape System worksurface
<b>SD</b>	saddle top
<b>30</b>	30" D
<b>48</b>	48" W

- Depth dimension is nominal. Depths are 1" less than stated to provide a 1" gap between the worksurface and panel to facilitate wire management.
- When manually specifying worksurface in laminate, add suffix "-S" to the code
- Optional pencil groove with Nuform
- To manually specify Nuform worksurfaces; begin with the desired thickness then build up options
- 1" thick worksurfaces are not available in laminate
- Stretcher bars are required to be specified with worksurfaces 54" and wider which do have any mid support- ensure not to interfere with support brackets, cable trays or other work tools

## NOTES

In order to get a total cost on products when an upcharge or downcharge is present you take the list price of the product number and add the upcharge or deduct the downcharge cost shown to the list price.

For example:

Product INSD3048 in Nuform Select with a tapered edge would be \$565 +\$59 +\$32

Product INSD3048 in Nuform Select with a 1" straight edge would be \$565 +\$59 -\$58

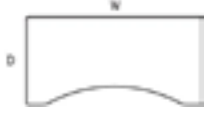
	Part number	W	D	1 1/4" straight edge Nuform classic/ laminate/base price	Nuform select	Nuform tapered edge	Nuform 1" straight edge	Grade 1 laminate 1 1/4" straight edge only
 <p>30" D Saddle Top</p>	<b>INSD3048</b>	48"	30"	\$565	+\$59	+\$32	-\$58	+\$182
	<b>INSD3054</b>	54"	30"	\$634	+\$66	+\$33	-\$64	+\$205
	<b>INSD3060</b>	60"	30"	\$708	+\$74	+\$36	-\$73	+\$228
	<b>INSD3066</b>	66"	30"	\$753	+\$77	+\$42	-\$76	+\$242
	<b>INSD3072</b>	72"	30"	\$847	+\$88	+\$44	-\$87	+\$274
	<b>INSD3084</b>	84"	30"	\$1017	+\$106	+\$54	-\$93	+\$327
	<b>INSD3096</b>	96"	30"	\$1199	+\$126	+\$64	-\$106	+\$386

# Worksurfaces & Supports

Panel Mounted Worksurfaces

90° Saddle Tops

# System

## PRODUCT CODE KEY EXAMPLE

INSWSD3047

**IN** Inscape System

**SWSD** 90° worksurface

**24** 30" D

**23** 47" W

- 90° worksurfaces are 1" less in length than standard worksurfaces to accommodate a wire management gap all the way around an L shaped workstation
- When manually specifying worksurface in laminate, add suffix "-S" to the code
- Optional pencil groove with Nuform
- To manually specify Nuform worksurfaces; begin with the desired thickness then build up options
- 1" thick worksurfaces are not available in laminate
- Stretcher bars are required to be specified with worksurfaces 54" and wider which do have any mid support – ensure not to interfere with support brackets, cable trays or other work tools



## NOTES

In order to get a total cost on products when an upcharge or downcharge is present you take the list price of the product number and add the upcharge or deduct the downcharge cost shown to the list price.

For example:

Product INSWSD3047 in Nuform Select with a tapered edge would be \$565 +\$59 +\$32

Product INSWSD3047 in Nuform Select with a 1" straight edge would be \$565 +\$59 -\$58

	Part number	W	D	1 1/4" straight edge Nuform classic/ laminate/base price	Nuform select	Nuform tapered edge	Nuform 1" straight edge	Grade 1 laminate 1 1/4" straight edge only
 30"D 90° Saddle Top	<b>INSWSD3047</b>	47"	30"	\$565	+\$59	+\$32	-\$58	+\$182
	<b>INSWSD3053</b>	53"	30"	\$634	+\$66	+\$33	-\$64	+\$205
	<b>INSWSD3059</b>	59"	30"	\$708	+\$74	+\$36	-\$73	+\$228
	<b>INSWSD3065</b>	65"	30"	\$753	+\$77	+\$42	-\$76	+\$242
	<b>INSWSD3071</b>	71"	30"	\$847	+\$88	+\$44	-\$87	+\$274
 36"D 90° Saddle Top	<b>INSWSD3647</b>	47"	36"	\$646	+\$64	+\$33	-\$70	+\$209
	<b>INSWSD3653</b>	53"	36"	\$723	+\$74	+\$37	-\$73	+\$234
	<b>INSWSD3659</b>	59"	36"	\$807	+\$87	+\$43	-\$86	+\$259
	<b>INSWSD3665</b>	65"	36"	\$860	+\$89	+\$46	-\$88	+\$277
	<b>INSWSD3671</b>	71"	36"	\$966	+\$98	+\$50	-\$97	+\$312

# Worksurfaces & Supports

Panel Mounted Worksurfaces  
Galley Tops

# System

## PRODUCT CODE KEY EXAMPLE

INWG362460

<b>INW</b>	Inscape System worksurface
<b>G</b>	galley top
<b>3624</b>	36 – 24" D
<b>4608</b>	60" W

- Depth dimension is nominal. Depths are 1" less than stated to provide a 1" gap between the worksurface and panel to facilitate wire management.
- When manually specifying worksurface in laminate, add suffix "-S" to the code
- Optional pencil groove with Nuform
- To manually specify Nuform worksurfaces; begin with the desired thickness then build up options
- 1" thick worksurfaces are not available in laminate
- Stretcher bars are required to be specified with worksurfaces 54" and wider which do have any mid support– ensure not to interfere with support brackets, cable trays or other work tools



## NOTES

In order to get a total cost on products when an upcharge or downcharge is present you take the list price of the product number and add the upcharge or deduct the downcharge cost shown to the list price.

For example:

Product INWG362460 in Nuform Select with a tapered edge would be \$783 +\$84 +\$37

Product INWG362460 in Nuform Select with a 1" straight edge would be \$783 +\$84 -\$76

	Part number	W	D	1 1/4" straight edge Nuform classic/ laminate/base price	Nuform select	Nuform tapered edge	Nuform 1" straight edge	Grade 1 laminate 1 1/4" straight edge only
 Left Hand Galley Top	<b>INWG362460</b>	60"	36-24"	\$783	+\$84	+\$37	-\$76	+\$252
	<b>INWG362466</b>	66"	36-24"	\$841	+\$88	+\$43	-\$87	+\$272
	<b>INWG362472</b>	72"	36-24"	\$935	+\$96	+\$48	-\$94	+\$301
	<b>INWG362478</b>	78"	36-24"	\$1035	+\$105	+\$54	-\$103	+\$332
	<b>INWG362484</b>	84"	36-24"	\$1137	+\$119	+\$59	-\$116	+\$366
	<b>INWG362490</b>	90"	36-24"	\$1170	+\$120	+\$64	-\$118	+\$376
	<b>INWG362496</b>	96"	36-24"	\$1228	+\$126	+\$69	-\$124	+\$395
 Right Hand Galley Top	<b>INWG243660</b>	60"	24-36"	\$783	+\$84	+\$37	-\$76	+\$252
	<b>INWG243666</b>	66"	24-36"	\$841	+\$88	+\$43	-\$87	+\$272
	<b>INWG243672</b>	72"	24-36"	\$935	+\$96	+\$48	-\$94	+\$301
	<b>INWG243678</b>	78"	24-36"	\$1035	+\$105	+\$54	-\$103	+\$332
	<b>INWG243684</b>	84"	24-36"	\$1137	+\$119	+\$59	-\$116	+\$366
	<b>INWG243690</b>	90"	24-36"	\$1170	+\$120	+\$64	-\$118	+\$376
	<b>INWG243696</b>	96"	24-36"	\$1228	+\$126	+\$69	-\$124	+\$395

# Worksurfaces & Supports

Panel Mounted Worksurfaces  
Standard Corners

# System

## PRODUCT CODE KEY EXAMPLE

INCR3636-22

**INCR** Inscape System  
standard corner

**3636** 36x 36" W

**24** 24" D

- Depth dimension is nominal. Depths are 1" less than stated to provide a 1" gap between the worksurface and panel to facilitate wire management.
- When manually specifying worksurface in laminate, add suffix "-S" to the code
- Optional pencil groove with Nuform
- To manually specify Nuform worksurfaces; begin with the desired thickness then build up options
- 48" Split Corner accommodates 24" or 30" returns
- Standard Corner and Split Corner include a radius front edge
- Limitations exist with the F09, F38, F40, F42, F43, F45, F46, F47, F48, F49, F50, F51, F57, F58 & F59 Nuforms due to the directional pattern. 48" w standard and split corners are not possible for the above referenced Nuform.
- 1" thick worksurfaces are not available in laminate
- Stretcher bars are required to be specified with worksurfaces 54" and wider which do have any mid support– ensure not to interfere with support brackets, cable trays or other work tools

## NOTES

In order to get a total cost on products when an upcharge or downcharge is present you take the list price of the product number and add the upcharge or deduct the downcharge cost shown to the list price.

For example:

Product INCR3636-22 in Nuform Select with a tapered edge would be \$505 +\$52 +\$29

Product INCR3636-22 in Nuform Select with a 1" straight edge would be \$505 +\$52 -\$51

Part number	W	D	1 1/4" straight edge Nuform classic/ laminate/base price	Nuform select	Nuform tapered edge	Nuform 1" straight edge	Grade 1 laminate 1 1/4" straight edge only
 <b>INCR3636-22</b>	36"	24"	\$505	+\$52	+\$29	-\$51	+\$164
<b>INCR4242-22</b>	42"	24"	\$719	+\$74	+\$37	-\$73	+\$233
<b>INCR4848-22</b>	48"	24"	\$875	+\$89	+\$47	-\$83	+\$282

Standard Corners  
24" returns

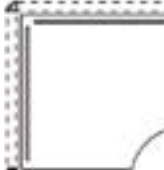
 <b>INCR4242-33</b>	42"	30"	\$719	+\$74	+\$37	-\$73	+\$233
<b>INCR4848-33</b>	48"	30"	\$875	+\$89	+\$47	-\$83	+\$282

Standard Corners  
30" returns

 <b>INCSLS4242-22</b>	42"	24"	\$1546	+\$64	—	-\$63	+\$496
<b>INCSLS4848</b>	48"	24 or 30"	\$1711	+\$70	—	-\$69	+\$549

Split Corners



# Worksurfaces & Supports

Panel Mounted Worksurfaces  
Extended Corners

# System

## PRODUCT CODE KEY EXAMPLE

INECR6036-22	
<b>INCR</b>	Inscape System
<b>ECR</b>	Extended corner worksurfaces
<b>60</b>	60" W
<b>36</b>	36" long
<b>-22</b>	24" deep returns on both ends

- Depth dimension is nominal. Depths are 1" less than stated to provide a 1" gap between the worksurface and panel to facilitate wire management.
- Extended Corners accommodate 24" deep returns
- When manually specifying worksurface in laminate, add suffix "-S" to the code
- Optional pencil groove with Nuform
- To manually specify Nuform worksurfaces; begin with thickness then build up options
- 1" thick worksurfaces are not available in laminate
- Stretcher bars are required to be specified with worksurfaces 54" and wider which do have any mid support- ensure not to interfere with support brackets, cable trays or other work tools

## NOTES

In order to get a total cost on products when an upcharge or downcharge is present you take the list price of the product number and add the upcharge or deduct the downcharge cost shown to the list price.

For example:

Product INECR6036-22 in Nuform Select with a tapered edge would be \$826 +\$86 +\$45

Product INECR6036-22 in Nuform Select with a 1" straight edge would be \$826 +\$86 -\$85

	Part number	W	D	1 1/4" straight edge Nuform classic/ laminate/base price	Nuform select	Nuform tapered edge	Nuform 1" straight edge	Grade 1 laminate 1 1/4" straight edge only
	<b>INECR6036-22</b>	60"	24"	\$826	+\$86	+\$45	-\$85	+\$266
	<b>INECR6636-22</b>	66"	24"	\$843	+\$89	+\$45	-\$88	+\$272
	<b>INECR7236-22</b>	72"	24"	\$859	+\$90	+\$47	-\$89	+\$277
	<b>INECR7836-22</b>	78"	24"	\$875	+\$91	+\$47	-\$90	+\$282
	<b>INECR8436-22</b>	84"	24"	\$897	+\$92	+\$48	-\$91	+\$288
	<b>INECR9036-22</b>	90"	24"	\$914	+\$94	+\$48	-\$93	+\$294
	<b>INECR9636-22</b>	96"	24"	\$933	+\$94	+\$50	-\$93	+\$300

36" Left Hand  
Extended Corners

	<b>INECR3660-22</b>	60"	24"	\$826	+\$86	+\$45	-\$85	+\$266
	<b>INECR3666-22</b>	66"	24"	\$843	+\$89	+\$45	-\$88	+\$272
	<b>INECR3672-22</b>	72"	24"	\$859	+\$90	+\$47	-\$89	+\$277
	<b>INECR3678-22</b>	78"	24"	\$875	+\$91	+\$47	-\$90	+\$282
	<b>INECR3684-22</b>	84"	24"	\$897	+\$92	+\$48	-\$91	+\$288
	<b>INECR3690-22</b>	90"	24"	\$914	+\$94	+\$48	-\$93	+\$294
	<b>INECR3696-22</b>	96"	24"	\$933	+\$94	+\$50	-\$93	+\$300

36" Right Hand  
Extended Corners

# Worksurfaces & Supports

Panel Mounted Worksurfaces  
Extended Corners

# System

## PRODUCT CODE KEY EXAMPLE

INECR6036-22	
<b>INCR</b>	Inscape System
<b>ECR</b>	Extended corner worksurfaces
<b>60</b>	60" W
<b>36</b>	36" long
<b>-22</b>	24" deep returns on both ends

- Depth dimension is nominal. Depths are 1" less than stated to provide a 1" gap between the worksurface and panel to facilitate wire management.
- Extended Corners accommodate 24" deep returns
- When manually specifying worksurface in laminate, add suffix "-S" to the code
- Optional pencil groove with Nuform
- To manually specify Nuform worksurfaces; begin with thickness then build up options
- 1" thick worksurfaces are not available in laminate
- Stretcher bars are required to be specified with worksurfaces 54" and wider which do have any mid support- ensure not to interfere with support brackets, cable trays or other work tools

## NOTES

In order to get a total cost on products when an upcharge or downcharge is present you take the list price of the product number and add the upcharge or deduct the downcharge cost shown to the list price.

For example:

Product INECR6036-22 in Nuform Select with a tapered edge would be \$826 +\$86 +\$45

Product INECR6036-22 in Nuform Select with a 1" straight edge would be \$826 +\$86 -\$85

	Part number	W	D	1 1/4" straight edge Nuform classic/ laminate/base price	Nuform select	Nuform tapered edge	Nuform 1" straight edge	Grade 1 laminate 1 1/4" straight edge only
	<b>INECR6042-22</b>	60"	24"	\$869	+\$89	+\$46	-\$88	+\$280
	<b>INECR6642-22</b>	66"	24"	\$885	+\$91	+\$46	-\$90	+\$285
	<b>INECR7242-22</b>	72"	24"	\$904	+\$92	+\$47	-\$91	+\$291
	<b>INECR7842-22</b>	78"	24"	\$923	+\$94	+\$48	-\$93	+\$296
	<b>INECR8442-22</b>	84"	24"	\$943	+\$96	+\$48	-\$94	+\$304
	<b>INECR9042-22</b>	90"	24"	\$962	+\$97	+\$51	-\$97	+\$310
	<b>INECR9642-22</b>	96"	24"	\$980	+\$102	+\$52	-\$100	+\$316

42" Left Hand  
Extended Corners

	<b>INECR4260-22</b>	60"	24"	\$869	+\$89	+\$46	-\$88	+\$280
	<b>INECR4266-22</b>	66"	24"	\$885	+\$91	+\$46	-\$90	+\$285
	<b>INECR4272-22</b>	72"	24"	\$904	+\$92	+\$47	-\$91	+\$291
	<b>INECR4278-22</b>	78"	24"	\$923	+\$94	+\$48	-\$93	+\$296
	<b>INECR4284-22</b>	84"	24"	\$943	+\$96	+\$48	-\$94	+\$304
	<b>INECR4290-22</b>	90"	24"	\$962	+\$97	+\$51	-\$97	+\$310
	<b>INECR4296-22</b>	96"	24"	\$980	+\$102	+\$52	-\$100	+\$316

42" Right Hand  
Extended Corners

# Worksurfaces & Supports

Panel Mounted Worksurfaces  
Extended Corners

# System

## PRODUCT CODE KEY EXAMPLE

INECR6042-33	
<b>IN</b>	Inscape System
<b>ECR</b>	Extended corner worksurfaces
<b>60</b>	60" W
<b>42</b>	42" long
<b>-33</b>	30" deep returns on both ends

- Depth dimension is nominal. Depths are 1" less than stated to provide a 1" gap between the worksurface and panel to facilitate wire management.
- Extended Corners accommodate 30" deep returns
- When manually specifying worksurface in laminate, add suffix "-S" to the code
- Optional pencil groove with Nuform
- To manually specify Nuform worksurfaces; begin with thickness then build up options
- 1" thick worksurfaces are not available in laminate
- Stretcher bars are required to be specified with worksurfaces 54" and wider which do have any mid support- ensure not to interfere with support brackets, cable trays or other work tools

## NOTES

In order to get a total cost on products when an upcharge or downcharge is present you take the list price of the product number and add the upcharge or deduct the downcharge cost shown to the list price.

For example:

Product INECR6042-33 in Nuform Select with a tapered edge would be \$1017 +\$104 +\$52

Product INECR6042-33 in Nuform Select with a 1" straight edge would be \$1017 +\$104 -\$102

	Part number	W	D	1 1/4" straight edge Nuform classic/ laminate/base price	Nuform select	Nuform tapered edge	Nuform 1" straight edge	Grade 1 laminate 1 1/4" straight edge only
	<b>INECR6042-33</b>	60"	30"	\$1017	+\$104	+\$52	-\$102	+\$327
	<b>INECR6642-33</b>	66"	30"	\$1037	+\$108	+\$56	-\$105	+\$333
	<b>INECR7242-33</b>	72"	30"	\$1059	+\$108	+\$56	-\$105	+\$341
	<b>INECR7842-33</b>	78"	30"	\$1138	+\$118	+\$58	-\$115	+\$366
	<b>INECR8442-33</b>	84"	30"	\$1160	+\$177	+\$72	-\$115	+\$373
	<b>INECR9042-33</b>	90"	30"	\$1208	+\$187	+\$72	-\$115	+\$388
	<b>INECR9642-33</b>	96"	30"	\$1237	+\$197	+\$72	-\$112	+\$397

42" Left Hand  
Extended Corners

	<b>INECR4260-33</b>	60"	30"	\$1017	+\$104	+\$52	-\$102	+\$327
	<b>INECR4266-33</b>	66"	30"	\$1037	+\$108	+\$56	-\$105	+\$333
	<b>INECR4272-33</b>	72"	30"	\$1059	+\$108	+\$56	-\$105	+\$341
	<b>INECR4278-33</b>	78"	30"	\$1138	+\$118	+\$58	-\$115	+\$366
	<b>INECR4284-33</b>	84"	30"	\$1160	+\$177	+\$72	-\$115	+\$373
	<b>INECR4290-33</b>	90"	30"	\$1208	+\$187	+\$72	-\$115	+\$388
	<b>INECR4296-33</b>	96"	30"	\$1237	+\$197	+\$72	-\$112	+\$397

42" Right Hand  
Extended Corners

# Worksurfaces & Supports

Panel Mounted Worksurfaces

120° Corners

# System

## PRODUCT CODE KEY EXAMPLE

INCRV3636-3F

<b>IN</b>	Inscape System
<b>CRV</b>	120 corner worksurfaces
<b>3636</b>	36" X 36" W
<b>-3F</b>	3 1/2" thick frame application

- Depth dimension is nominal. Depths are 1" less than stated to provide a 1" gap between the worksurface and panel to facilitate wire management.
- 120° worksurfaces accommodate 24" deep returns on either side
- "2F" denotes use with 2 3/4" thick frame, "3F" denotes use with 3 1/2" thick frame
- When manually specifying worksurface in laminate, add suffix "-S" to the code
- Optional pencil groove with Nuform
- To manually specify Nuform worksurfaces; begin with the desired thickness then build up options
- 1" thick worksurfaces are not available in laminate
- Stretcher bars are required to be specified with worksurfaces 54" and wider which do have any mid support– ensure not to interfere with support brackets, cable trays or other work tools

## NOTES

In order to get a total cost on products when an upcharge or downcharge is present you take the list price of the product number and add the upcharge or deduct the downcharge cost shown to the list price.

For example:

Product INCRV3636-2F in Nuform Select with a tapered edge would be \$539 +\$54 +\$31

Product INCRV3636-2F in Nuform Select with a 1" straight edge would be \$539 +\$54 -\$53

Part number	W	D	1 1/4" straight edge Nuform classic/ laminate/base price	Nuform select	Nuform tapered edge	Nuform 1" straight edge	Grade 1 laminate 1 1/4" straight edge only
<b>INCRV3636-3F</b>	36"	24"	\$539	+\$54	+\$31	-\$53	+\$174
<b>INCRV4242-3F</b>	42"	24"	\$767	+\$79	+\$43	-\$77	+\$247
<b>INCRV4848-3F</b>	48"	24"	\$939	+\$94	+\$48	-\$93	+\$302

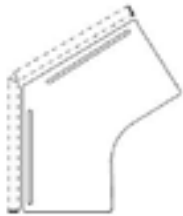

120° Corner Worksurfaces  
For use with 3 1/2" T Frames

<b>INCRV3636-2F</b>	36"	24"	\$539	+\$54	+\$31	-\$53	+\$174
<b>INCRV4242-2F</b>	42"	24"	\$767	+\$79	+\$43	-\$77	+\$247
<b>INCRV4848-2F</b>	48"	24"	\$939	+\$94	+\$48	-\$93	+\$302

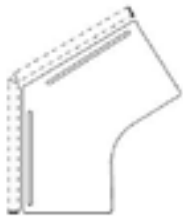

120° Corner Worksurfaces  
For use with 2 3/4" T Frames

# Worksurfaces & Supports

Panel Mounted Worksurfaces  
Conference Tops

# System

## PRODUCT CODE KEY EXAMPLE

INCTR3060

<b>IN</b>	Inscape System
<b>CTR</b>	Conference top
<b>30</b>	30" D
<b>60</b>	60" W

- Conference Tops are 1" less in width to provide 1" gap between worksurface and panel
- Conference Tops depths are true sized
- When manually specifying worksurface in laminate, add suffix "-S" to the code
- Optional pencil groove with Nuform
- To manually specify Nuform worksurfaces; begin with the desired thickness then build up options
- Support brackets to panel and leg specified separately
- 1" thick worksurfaces are not available in laminate
- Stretcher bars are required to be specified with worksurfaces 54" and wider which do have any mid support– ensure not to interfere with support brackets, cable trays or other work tools

## NOTES

In order to get a total cost on products when an upcharge or downcharge is present you take the list price of the product number and add the upcharge or deduct the downcharge cost shown to the list price.

For example:

Product INCTR3060 in Nuform Select would be \$823 +\$88

Product INCTR3060 in Nuform Select with a 1" straight edge would be \$823 +\$88 -\$87

	Part number	W	D	1 1/4" straight edge Nuform classic/ laminate/base price	Nuform select	Nuform tapered edge	Nuform 1" straight edge	Grade 1 laminate 1 1/4" straight edge only
	<b>INCTR3060</b>	60 (59)"	30"	\$823	+\$88	—	-\$87	+\$265
	<b>INCTR3066</b>	66 (65)"	30"	\$875	+\$91	—	-\$90	+\$282
	<b>INCTR3072</b>	72 (71)"	30"	\$974	+\$94	—	-\$52	+\$314
	<b>INCTR3078</b>	78 (77)"	30"	\$1092	+\$112	—	-\$108	+\$351

Rectangular Top  
Top only

	<b>INCTB3060</b>	60 (59)"	30"	\$823	+\$88	—	-\$87	+\$265
	<b>INCTB3066</b>	66 (65)"	30"	\$876	+\$91	—	-\$90	+\$282
	<b>INCTB3072</b>	72 (71)"	30"	\$976	+\$100	—	-\$76	+\$314
	<b>INCTB3078</b>	78 (77)"	30"	\$1092	+\$112	—	-\$108	+\$351

Bullet Top  
Top only

## Worksurfaces & Supports

Transaction tops  
General Information

# System

Transaction tops are commonly specified for reception areas but have a variety of applications including help desks and banks.

Transaction Tops are commonly specified with 37" high panels. Widths indicated refer to panel width. Stanchions and top trim are included. Installed height of transaction top on 37" high panel is 41 1/2". Transaction Top worksurfaces are 1" thick and available in Nuform options. The edge detail is straight only. Transaction tops are panel thickness specific.

The suffix "2F" denotes compatibility with 2 3/4" thick panel, "3F" denotes compatibility with 3 1/2" thick panel.

**Note: 72", 84" and 96" W kits consist of two top caps and four stanchions (based on "Symmetrical Frame Configuration" module lines). Top Caps can be specified as an option and are included with the kit.**

### GENERAL

- Straight-line transaction tops are available
- Straight-line transaction tops are 12" deep and are available in the following widths: 24", 30", 36", 42", 48", 54", 60", 72", 84" and 96"
- Transaction tops may be specified for 37" standard frames. Overall height of 37" high frame and transaction top is 41 1/2"
- All transaction tops shorter than 72" W are supported by 2 stanchions
- Transaction tops 72" or wider include two top trims and four stanchions
- A top trim with two cutouts, to accommodate the stanchions, is included with each transaction top
- Stanchions are not height adjustable
- Do not specify upper deck electrical beneath

### PRODUCT CODE KEY EXAMPLE

#### INTT1236-3F

INTT	Inscape System rectangular transaction top
12	12" D
36	36" W
3F	3 1/2" thick frame application



## Worksurfaces & Supports

Transaction Tops  
For 3 1/2" Thick Frames

# System

- Straight Edge Nuform worksurface
- 1" thick worksurface
- Specific frame configurations only for the spanning tops
- 72" (36" top caps), 84" (42" top caps) and 96" (48" top caps) wide kits consist of two top caps and four stanchions
- On-module installation only
- Stanchions have a rectangular profile

### NOTES

In order to get a total cost on products when an upcharge or downcharge is present you take the list price of the product number and add the upcharge or deduct the downcharge cost shown to the list price.

For example:

Product INTT1224-3F in Nuform Select with tapered trim would be \$374 +\$21

	Part number	H	W	Tapered trim		Flat trim		Accent paint
				1" Straight edge Nuform classic/base price	1" Nuform select	1" Straight edge Nuform classic/base price	1" Nuform select	
 <p>Rectangular Transaction Top</p>	<b>INTT1224-3F</b>	12"	24"	\$374	+\$21	\$374	+\$21	+\$39
	<b>INTT1230-3F</b>	12"	30"	\$400	+\$22	\$400	+\$22	+\$44
	<b>INTT1236-3F</b>	12"	36"	\$426	+\$23	\$426	+\$23	+\$46
	<b>INTT1242-3F</b>	12"	42"	\$451	+\$25	\$451	+\$25	+\$48
	<b>INTT1248-3F</b>	12"	48"	\$486	+\$27	\$486	+\$27	+\$51
	<b>INTT1254-3F</b>	12"	54"	\$511	+\$29	\$511	+\$29	+\$53
	<b>INTT1260-3F</b>	12"	60"	\$517	+\$29	\$517	+\$29	+\$54
	<b>INTT1272-3F</b>	12"	72"	\$848	+\$45	\$848	+\$45	+\$88
	<b>INTT1284-3F</b>	12"	84"	\$898	+\$47	\$898	+\$47	+\$92
	<b>INTT1296-3F</b>	12"	96"	\$961	+\$50	\$961	+\$50	+\$99

## Worksurfaces & Supports

Transaction Tops  
For 2 3/4" Thick Frames

# System

- Straight Edge Nuform worksurface
- 1" thick worksurface
- Specific frame configurations only for the spanning tops
- 72" (36" top caps), 84" (42" top caps) and 96" (48" top caps) wide kits consist of two top caps and four stanchions
- On-module installation only
- Stanchions have a rectangular profile

### NOTES

In order to get a total cost on products when an upcharge or downcharge is present you take the list price of the product number and add the upcharge or deduct the downcharge cost shown to the list price.

For example:

Product INTT1224-2F in Nuform Select with flat trim would be \$374 +\$21

	Part number	H	W	Tapered trim		Flat trim		Accent paint
				1" Straight edge Nuform classic/base price	1" Nuform select	1" Straight edge Nuform classic/base price	1" Nuform select	
 <p>Rectangular Transaction Top</p>	<b>INTT1224-2F</b>	12"	24"	—	—	\$374	+\$21	+\$39
	<b>INTT1230-2F</b>	12"	30"	—	—	\$400	+\$22	+\$44
	<b>INTT1236-2F</b>	12"	36"	—	—	\$426	+\$23	+\$46
	<b>INTT1242-2F</b>	12"	42"	—	—	\$451	+\$25	+\$48
	<b>INTT1248-2F</b>	12"	48"	—	—	\$486	+\$27	+\$51
	<b>INTT1254-2F</b>	12"	54"	—	—	\$511	+\$29	+\$53
	<b>INTT1260-2F</b>	12"	60"	—	—	\$517	+\$29	+\$54
	<b>INTT1272-2F</b>	12"	72"	—	—	\$848	+\$45	+\$88
	<b>INTT1284-2F</b>	12"	84"	—	—	\$898	+\$47	+\$92
	<b>INTT1296-2F</b>	12"	96"	—	—	\$961	+\$50	+\$99



## END GABLE & END GABLE BRACKETS

End gable & end gable brackets support panel mounted worksurfaces 28.5" high and. The left and right-handed brackets match the height of the end gable. End gables and brackets are available in any of Inscape's standard paint finishes and are frame thickness specific.

## 'H' LEG

'H' leg is a freestanding leg which may also be specified in a panel mounted application. Small glides provide leveling capability.

## 'O' LEG

'O' leg is a fully welded 'O' structure which mounts to the underside of a worksurface. This leg is freestanding.

## FRAMED LEG

Framed leg is a panel mounted worksurface support that has the bracket to attach to panel incorporated in the design. Legs are specified based on depth of worksurface. Small leveling glide included with no glide cap. For version with glide cap see standard specials.

## CANTILEVER BRACKET

Cantilever brackets support panel mounted worksurfaces on-module and are available in fixed or adjustable. Brackets are handed and adjustable to achieve 5 standard worksurface heights: 24.5", 27", 28.5", 30" and 31.5". Fixed cantilever brackets do not adjust vertically.

## MID SPAN CANTILEVER BRACKET

The mid span cantilever bracket is specified when there is a long tile being specified in the zone directly above the bottom 20.25" H tile which would interfere with the middle upright for a standard cantilever to attach into. The Mid Span Cantilever mounts lower to the upright allowing the wide tile aesthetic.

## CORNER CANTILEVER BRACKET

The corner cantilever bracket is specified where the 1" gap behind a worksurface wraps around a corner.

## BRIDGE BRACKET

Bridge bracket install onto Cantilever brackets only. These brackets are handed and an adjustable version is available to achieve the same five heights as Cantilever brackets. Fixed bridge brackets do not adjust vertically and must only be specified with fixed Cantilever brackets.

## FLUSH BRACKETS

Flush brackets are specified when two adjoining worksurfaces need to be held flush together and come in pairs. Maximum span of overhang when supported with a flush bracket is 18" per side.

## MULTI SURFACE SUPPORT BRACKETS

Multi surface support brackets are adjustable to achieve five standard worksurface heights: 25.5", 27", 28.5", 30" and 31.5". MSSB's provide corner support for panel-mounted worksurfaces, support panel mounted conference tops and provide mid-span support for worksurfaces up to 72" W. MSSB's are handed and may be specified for either thickness of Inscape System panel. Fixed Multi-surface Support Brackets are available and do not adjust vertically.

## FRONT EDGE SUPPORT BRACKETS

Front edge support brackets provide front edge support for 24" and 30" deep worksurfaces and also dock freestanding tables to panel's on-module. Brackets may be positioned to achieve five standard worksurface heights. Front Edge Support Brackets are handed and may be specified for either thickness of panel.

## FRAMED LEG FRONT SUPPORT BRACKET

The framed leg front support bracket provides additional stability to a wing panel which is longer than the depth of the adjacent worksurface. The bracket must have access to a crossrail (at any location within the height of the leg) via a segmentation in tiles. The bracket is then double side taped to the inside of the leg.

## PLANNA SUPPORT BRACKET

Planna support bracket is specified to be mounted on Planna rail and floats the worksurface off the bracket. Bracket is available in all standard paint colors. Bracket "snaps" into the rail without the need for tools. These are shipped as a pair and both must be installed per worksurface.

## HAT CHANNEL

Hat channels are used to support a worksurface off of a 21" ID Planna storage case and are available in any of Inscape's standard paint finishes. They are nominal in height and support a worksurface at a standard 28.5" height.

### **WORKSURFACE STRETCHER BAR**

Worksurface stretcher bar is additional structural support for unsupported worksurfaces of 54" or greater. It is 1 ½" high and the length of the stretcher bar is chosen based on the width of the worksurface. Be sure that there are no legs or panel mounted worksurface support brackets that may interfere with the stretcher bar.

### **WORKSURFACE TO TOWER BRACKET**

This bracket is attached to a storage unit with screws (included) to support a worksurface from the underside. The 18" W bracket is used in a lateral, bookcase or locker application. The 24" W bracket is used with modular and workplace towers. These brackets are painted. Silicone caps to cover exposed screw tips are provided.

### **1.5" SCREEN DOCKING BRACKETS**

Brackets dock the screen to a worksurface but are NOT worksurface supporting. Worksurfaces must always be freestanding. The Single Docking bracket docks one surface to a screen, the double docks two surfaces on either side of the screen. The Front edge docks the front edge of a freestanding table to the edge of a screen. Mid Span Docking bracket simply dock the mid of the worksurface to the 1.5" screen but does not support it.

# Worksurfaces & Supports

## Supports

### Panel Mounted Worksurface Supports

# System



- Worksurface support brackets are universal between two panel thicknesses (unless otherwise stated)
- Value Engineer Option – Eco Black finish
- If visible it is suggested the paint option be chosen
- Cantilevers cannot be specified to support 20"d or less worksurfaces

### NOTES

In order to get a total cost on products when an upcharge or downcharge is present you take the list price of the product number and add the upcharge or deduct the downcharge cost shown to the list price.

For example:

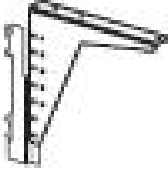
INLHCBFX in neutral paint would be \$46 +\$13INLHCBFX  
in accent paint would be \$46 +\$13 +\$8

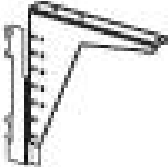
		Part number	H	Wt (lbs)	Eco black/ base price	Neutral paint	Accent paint
	Cantilever Bracket Fixed Height Handed	<b>INLHCBFX</b>	—	5	\$46	+\$13	+\$8
		<b>INRHCBFX</b>	—	5	\$46	+\$13	+\$8
	Cantilever Bracket Adjustable Height Handed	<b>INLHCB</b>	—	5	\$54	+\$20	+\$9
		<b>INRHCB</b>	—	5	\$54	+\$20	+\$9
	Mid Span Cantilever Bracket Fixed Height Handed	<b>INLHCBS</b>	—	5	\$81	+\$13	+\$11
		<b>INRHCBS</b>	—	5	\$81	+\$13	+\$11
	Corner Cantilever Bracket Adjustable Height Handed	<b>INLHCB1CRNR</b>	—	5	\$93	+\$13	+\$12
		<b>INRHCB1CRNR</b>	—	5	\$93	+\$13	+\$12

# Worksurfaces & Supports

## Supports

### Panel Mounted Worksurface Supports

# System



- Worksurface support brackets are universal between two panel thicknesses (unless otherwise stated)
- Value Engineer Option – Eco Black finish
- If visible it is suggested the paint option be chosen
- Cantilevers cannot be specified to support 20" d or less worksurfaces

### NOTES

In order to get a total cost on products when an upcharge or downcharge is present you take the list price of the product number and add the upcharge or deduct the downcharge cost shown to the list price.

For example:

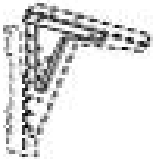
INBBFX in neutral paint would be \$16 +\$8 INBBFX in accent paint would be \$16 +\$8 +\$6

		Part number	H	Wt (lbs)	Eco black/ base price	Neutral paint	Accent paint
	Bridge Bracket Fixed Height	<b>INBBFX</b>	—	1	\$16	+\$8	+\$6
	Bridge Bracket Adjustable Height Handed	<b>INLBB</b> <b>INRBB</b>	— —	1 1	\$25 \$25	+\$11 +\$11	+\$6 +\$6
	Multi Surface Support Bracket Fixed Height Handed	<b>INLHMSSBFX</b> <b>INRHMSSBFX</b>	— —	2 2	\$22 \$22	+\$8 +\$8	+\$6 +\$6
	Multi Surface Support Bracket Adjustable Height Handed	<b>INLHMSSB</b> <b>INRHMSSB</b>	— —	2 2	\$36 \$36	+\$11 +\$11	+\$7 +\$7

# Worksurfaces & Supports

## Supports

### Panel Mounted Worksurface Supports

# System

- Worksurface support brackets are universal between two panel thicknesses (unless otherwise stated)
- Value Engineer Option – Eco Black finish
- If visible it is suggested the paint option be chosen
- A break in tile segmentation (horizontally) below the worksurface must be present for the Framed Leg Front Support Bracket to attach to the crossrail of the panel
- "H" Leg Docking Bracket ties an "H" leg or "O" leg into a frame





### NOTES

In order to get a total cost on products when an upcharge or downcharge is present you take the list price of the product number and add the upcharge or deduct the downcharge cost shown to the list price.

For example:

INLHFSB in neutral paint would be \$27 +\$20

INLHFSB in accent paint would be \$27 +\$20 +\$7

		Part number	H	Wt (lbs)	Eco black/ base price	Neutral paint	Accent paint
	Front Edge Support Bracket	<b>INLHFSB</b>	—	1	\$27	+\$20	+\$7
	Fixed Height Handed	<b>INRHFSB</b>	—	1	\$27	+\$20	+\$7
	Framed Leg Front Support Bracket	<b>INLHPFRSB</b>	—	1	—	\$37	+\$8
	Adjustable Height Handed	<b>INRHHPFRSB</b>	—	1	—	\$37	+\$8
	"H" Leg Docking Bracket For use with 3 1/2" T Frames	<b>INLHHLDB-3F</b>	—	1	—	\$87	+\$12
	Handed	<b>INRHHLDB-3F</b>	—	1	—	\$87	+\$12
	"H" Leg Docking Bracket For use with 2 3/4" T Frames	<b>INLHHLDB-2F</b>	—	1	—	\$87	+\$12
	Handed	<b>INRHHLDB-2F</b>	—	1	—	\$87	+\$12





# Worksurfaces & Supports

## Supports

### Panel Mounted Worksurface Supports

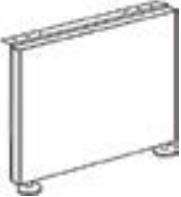
# System

- “2F” denotes use with 2 ¾" thick frame, “3F” denotes use with 3 ½" thick frame
- Worksurface support brackets are universal between two panel thicknesses (unless otherwise stated)
- Value Engineer Option – Eco Black finish
- If support is visible it is suggested the paint option be chosen
- End panel must be docked to the frame with brackets
- Frame Support Leg mounts to both thicknesses of panel
- Frame Support Legs are handed and based on which side of frame attaching to
- The Center Frame Support Leg cannot be used in an end location

		Part number	H	Wt (lbs)	Eco black/ base price	Neutral paint	Accent paint
	End Panel Bracket For use with 3 ½" T Frames Handed	<b>INLHEGB28.5-3F</b>	28 ½"	5	—	\$94	+\$12
		<b>INRHEGB28.5-3F</b>	28 ½"	5	—	\$94	+\$12
	End Panel Bracket For use with 2 ¾" T Frames Handed	<b>INLHEGB28.5-2F</b>	28 ½"	5	—	\$94	+\$12
		<b>INRHEGB28.5-2F</b>	28 ½"	5	—	\$94	+\$12
	End Panel	<b>INEG2428.5</b>	28 ½"	50	—	\$351	+\$36
		<b>INEG3028.5</b>	28 ½"	50	—	\$357	+\$37
	Left Hand Frame Support Leg New Style	<b>INLFRMLEG2428.5</b>	28 ½"	24"		\$391	+\$43
		<b>INLFRMLEG3028.5</b>	28 ½"	30"		\$438	+\$47
		<b>INLFRMLEG3628.5</b>	28 ½"	36"		\$488	+\$51
	Right Hand Frame Support Leg New Style	<b>INRFRMLEG2428.5</b>	28 ½"	24"		\$391	+\$43
		<b>INRFRMLEG3028.5</b>	28 ½"	30"		\$438	+\$47
		<b>INRFRMLEG3628.5</b>	28 ½"	36"		\$488	+\$51
	Centre Framed Support Leg New Style	<b>INCFRMLEG2428.5</b>	28 ½"	24"		\$391	+\$43
		<b>INCFRMLEG3028.5</b>	28 ½"	30"		\$438	+\$47
		<b>INCFRMLEG3628.5</b>	28 ½"	36"		\$488	+\$51

# Worksurfaces & Supports

Supports  
Worksurface Supports

# System

- Value Engineer Option – Eco Black finish
- If bracket visible it is suggested the paint option be chosen
- Stretcher bars are required to be specified with worksurfaces 54" and wider which do have any mid support– ensure not to interfere with support brackets, cable trays or other work tools
- Stretcher bars are 1 ½" high

## NOTES







In order to get a total cost on products when an upcharge or downcharge is present you take the list price of the product number and add the upcharge or deduct the downcharge cost shown to the list price.

For example:

INWMB24-36 in neutral paint would be \$33

+\$11INWMB24-36 in accent paint would be \$33 +\$11

+\$7

		Part number	Wt (lbs)			List price	
	Flush Bracket Kit of 2	<b>INFB</b>	0.2			\$18	
	20" Flush Bracket	<b>INFB20</b>	1			\$26	
	Screws for Worksurfaces (box of 100)	<b>INCBSCREWS</b>	0.5			\$29	
		Part number	W	Wt (lbs)	Eco black/ base price	Neutral paint	Accent paint
	Worksurface Stretcher Bar For use with worksurfaces 54" and wider	<b>INSBK54</b>	44"	—	\$77	—	—
		For use with 54" surface					
		<b>INSBK60</b>	50"	—	\$114	—	—
		For use with 60" surface					
		<b>INSBK72</b>	62"	—	\$135	—	—
	For use with 72" surface						
		<b>INSBK84</b>	74"	—	\$162	—	—
	For use with 84" surface						
		<b>INSBK96</b>	86"	—	\$183	—	—
	For use with 96" surface						
	Wall Mount Bracket	<b>INWMB24-36</b>	24-36"	—	\$33	+\$11	+\$7
		<b>INWMB42-54</b>	42-54"	—	\$44	+\$13	+\$8
		<b>INWMB60-72</b>	60-72"	—	\$59	+\$18	+\$9
	Storage to worksurface bracket	<b>INMTWBKT-18</b>	18"	—	—	\$36	+\$7
		Lateral/locker application					
		<b>INMTWBKT-24</b>	24"	—	—	\$53	+\$9
	Modular tower application						



## Worksurfaces & Supports

### Supports

#### Planna Worksurface Support Brackets

# System

- Planna Storage Support Brackets are shipped as a pair and are both required per Planna Storage worksurface installation
- Hat Chanel heights are nominal and they support a standard worksurface height of 28.5"

		Part number	H	Wt (lbs)	Natural paint/ base price	Accent paint
	Planna Bracket (pair) Adjustable Height	<b>PSUPBKT</b>	—	1	\$92	+\$12
	9" W x 2.89"H Hat Channel For use over Planna case with 1/2" top with no rail	<b>HATCHNL2.89</b>	2.89"	2	\$52	+\$9
	9" W x 2.375"H Hat Channel For use over Planna case with 1/2" top and 1/2" rail	<b>HATCHNL2.3759</b>	2.375"	2	\$52	+\$9







# Worksurfaces & Supports

## Supports

### Legs and Leg Docking Brackets

# System

- Height adjustable leg provides manual adjustability to five heights -25.5", 27", 28.5", 30", 31.5"
- Legs are available in any of Inscape's standard paint colors
- To adjust the height there are two bolts that unthread and then pull out so that inner leg can then move up and down

		Part number	H	Wt (lbs)	Natural paint/ base price	Accent paint
	"H" Leg Fixed Height	<b>INHLEG2428.5</b>	28 ½"	—	\$485	+\$51
		<b>INHLEG3028.5</b>	28 ½"	—	\$511	+\$53
		<b>INHLEG3628.5</b>	28 ½"	—	\$529	+\$56
	"O" Leg Fixed Height	<b>INOLEG2428.5</b>	28 ½"	—	\$403	+\$44
		<b>INOLEG3028.5</b>	28 ½"	—	\$416	+\$45
		<b>INOLEG3628.5</b>	28 ½"	—	\$421	+\$45
	Post Leg Fixed Height Existing Storwal Storage version	<b>INLEG28.5F</b>	28 ½"	3	\$192	+\$22
	Post Leg Fixed Height	<b>INPLEG28.5F</b>	28 ½"	5	\$199	+\$22
	Post Leg Adjustable Height	<b>INPLEGM</b>	28 ½"	7	\$319	+\$34



# Worksurfaces & Supports

## Supports

### Legs and Leg Docking Brackets

# System

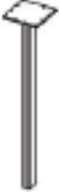
- Height adjustable leg provides manual adjustability to five heights -25.5", 27", 28.5", 30", 31.5"
- Legs are available in any of Inscape's standard paint colors
- The Triangular post leg provides concealed wire management

		Part number	H	Wt (lbs)	Natural paint/ base price	Accent paint
	Round Post Leg Fixed Height	<b>INFFLEG28.5</b>	28 ½"	4	\$89	+\$12
	Rectangular Post Leg	<b>INRECPLEG-28.5</b>	28 ½"	—	\$171	+\$20
	Triangular Leg Fixed Height	<b>INTWMLEG-28.5</b>	28 ½"	—	\$258	+\$27



## Worksurfaces & Supports

### Supports

#### 1 1/2" Screen Worksurfaces Docking Brackets

# System

- Docking brackets only, not worksurface supporting - legs for surfaces are required
- Compatible with 1" and 1 1/4" thick worksurfaces
- Brackets are available in any of Inscape's standard paint colors

		Part number	Wt (lbs)	Natural paint/ base price	Accent paint
	1.5" Screen Single Docking Bracket	<b>FWSDB</b>	2	\$30	+\$7
	1.5" Screen Back to Back Docking Bracket	<b>FWSBDB</b>	2	\$47	+\$8
	1.5" Screen Front Edge Docking Bracket	<b>FWSFESB</b>	2	\$33	+\$7
	1.5" Screen Mid-Span Docking Bracket	<b>FF-MSSB</b>	1	\$23	+\$6

# System Storage

**inscape**

work for tomorrow

**Storage**  
Lock locations

# System

For all product lines except modular towers and Nuform.

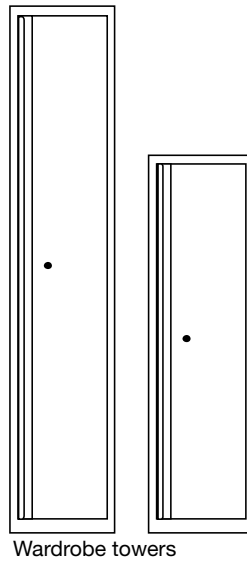
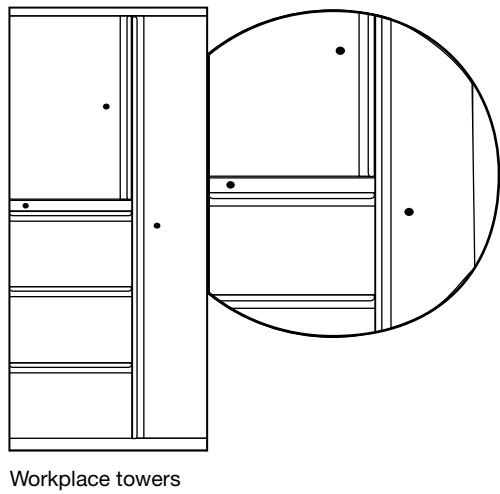
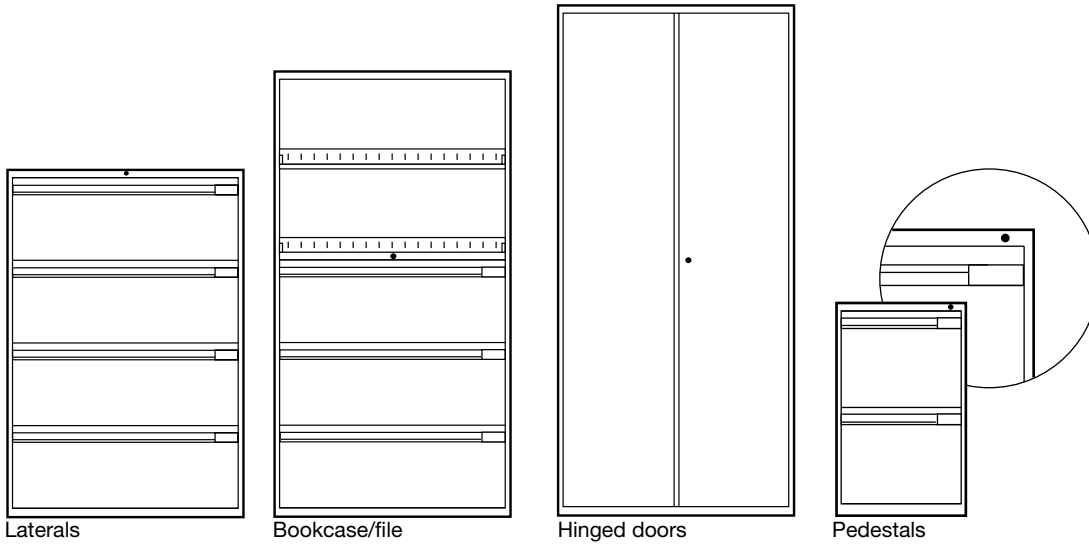

**Storage**  
Lock locations

# System

Nuform.

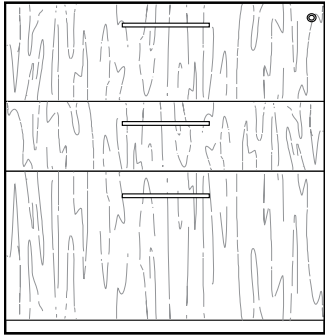

Laterals

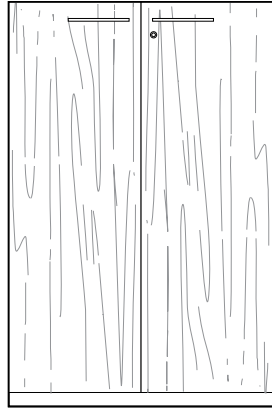

Hinged doors  
- 24" interior height

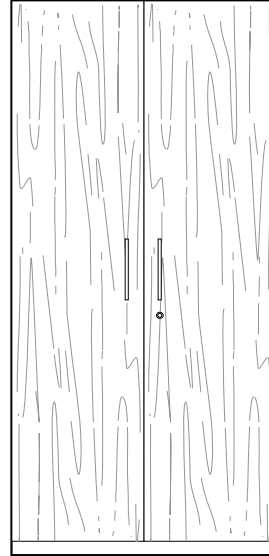

Hinged doors  
- all except 24" interior height

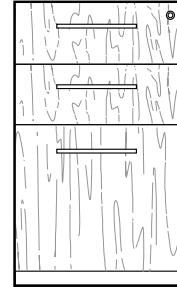

Pedestals

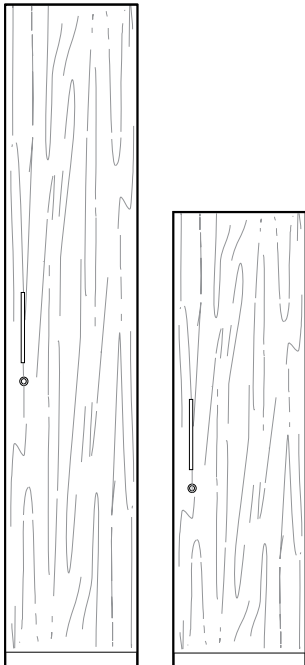

Wardrobe towers

Pedestals are of all-welded "wrap-around" construction of 20 and 22 gauge high quality, tension leveled, cold rolled steel. The steel gauge selected for drawer fronts, bodies and accessories ensure the highest quality durability and performance for all components. All glides on cases consist of flat glides with 5/8" height adjustability. Pedestal corners are welded at junction of top and case, eliminating horizontal lines for a cleaner, flush appearance, and strengthened with reinforcing gussets. A completely enclosed case provides rigid construction and dust-free interiors.

### **ANSI/BIFMA**

With the addition of counterweights where appropriate, cabinets meet all BIFMA specifications.

### **CONSTRUCTION FEATURES & BENEFITS**

Box drawer sides are slotted on 1" centers to allow for maximum flexibility for drawer division. Double-wall construction allows lift-up doors to be picked up and recede smoothly, eliminates deformation, ensures flush fit within cabinet and improves lock performance. Storage with Handles is single-wall construction. File (10.5" and 12") and EDP (15") drawer bodies have full-height sides to accommodate hanging file folders, eliminating the need for optional file frames. Fully progressive ball bearing suspensions on all drawers, including pencil and box drawers, are staged so that the left and right sides work in unison; this provides smooth drawer operation with minimum force. Staged suspensions allow the drawer to be completely pulled out, providing access to the entire drawer depth.

Special "claw-like" device incorporated in the suspension "grips" the fixed section of the suspension channel preventing drawer body bounce back or creep when drawer is closed. Modular interior allows complete interchangeability of drawer types within the pedestal case. For example, two 6" box drawers may be replaced by a 12" file drawer. Pedestals are standard with keyholes for attachment to underside of worksurface. For the Storage with Handles only cases: 18" deep pedestals come standard with 18" deep drawers, 22" and 28" deep pedestals come standard with 22" deep drawers. For all other Series, pedestal drawers match case depth.

Pedestals are available in mobile and worksurface supporting. Worksurface supporting pedestals are designed for use with the Inscape System and are standard with flat glides. Worksurface supporting pedestals are available in two depths to fit under 24" and 30" deep worksurfaces and support finished worksurface height of 28.5". Pedestals with 3", 6" or 7.5" drawers have the option to order one pencil tray per pedestal. The 6" and 7.5" drawers have the additional option to order one steel divider. The 10.5" and 12" drawers have the option to order one hang file suspension bar (two in a 28" deep pedestal) for side-to-side filing of legal or letter size folders or printout binders. Storage with Handles Pedestals do not include any suspension bars.

**NOTE: System storage pedestal cases consist of holes in the top of the case and back of the case to allow for worksurface docking and panel mounted brackets to be secured.**

### **COUNTERWEIGHTS**

Counterweights are required for ALL freestanding units that are not anchored or ganged to other cabinets or bolted to walls/floor. Counterweights come standard with ALL mobile pedestals and must be field installed.

### **OPTIONAL HANDLE**

Mobile Pedestals have the option to select a face mounted contemporary style handle for the case. There is an upcharge of \$32 list if this handle is selected. This handle is available in two finish options: Brushed Nickel (default) or Polished Nickel.

### **DOCKING BRACKET**

The pedestal docking bracket docks a pedestal to an Inscape System panel on-module. Specify bracket according to case front style and based on the thickness of panel. Pedestal -to-panel brackets are available in full height version.

### **GLIDES**

Inscape System pedestals are standard with flat glides. Glides provide 0.125" height adjustment when docked and 0.75" height adjustment if unit is not docked. 2 glides in front and 2 in back are adjustable from inside the cabinet so that cabinets can be leveled regardless of whether they are backed against a wall or banked.

### **LOCKS**

Standard with single bitted lock. If lock is not required add suffix 'NL' after product number and deduct \$57 list per lock. For applications requiring higher security a double bitted solution is available. Random keying is standard, and keyed alike may be ordered. Master keys are available; refer to the accessories section to specify.

Cabinets originally ordered as non-locking may be field installed with the addition of locking bars and a lock core. Contact your client services representative for required parts.

Locks feature removable core and are standard with two keys, one of which has a black neoprene plastic key cover. Locks may be ordered for field installation. Specify cabinet height and width or model number.

**NOTE: Locks cannot be field installed on hinged door cabinets.**



**9900 Series NOTE: Pedestals with 9900 series fronts must be specified beneath 1" Nuform worksurfaces only.**

### FINISHES

All laterals are finished in standard 36.5° gloss baked enamel, electrostatically applied in a 2-coat process. Refer to the surface materials section for available colors. With the exception of custom micas, whites and metallic; custom colors are available at an up-charge and are be subject to extended lead times. All interior drawers/ shelf bodies, exposed hardware (excluding European style hinges) hang file bars, dividers and media frames are finished in Eco Black.

### FRONT DETAILS & PULL OPTIONS

9900 Series fronts have full width integral pulls with enamel finish to match case fronts. Storage with Handles is single-wall construction. Refer to the images and chart below for pull application on Storage with Handles and Nuform fronts.

Pull	Storage with Handles	Nuform
 <b>FP001</b> P290 Aluminum Leaf Finish	●	●
 <b>FP004</b> Brushed Nickel Finish	●	●
 <b>FP005</b> Brushed Nickel Finish	●	○

● Available    ○ Unavailable

Pulls FP004 and FP005 meet the guidelines for ADA compliance.

**FP005 is the default pull for Storage with Handles**

**FP001 is the default pull for Nuform**



## CUSHION MOBILE PEDESTALS

The **Classic Cushion** is 1 ¼" thick CAL 117 compliant polyurethane foam with a 2.3 lb/ft. density. This upholstered cushion is balanced with a 7/16" board and is attached to the pedestal top with heavy duty Velcro. The 5-pc construction, features double row top stitching on all seams, seen in fine upholstered pieces. The result provides crisp rectilinear styling.

The **Lite Cushion** is ¾" thick CAL 117 compliant polyurethane foam with a 2.3 lb/ft. density. This upholstered cushion is balanced with a ¼" board and is attached to the pedestal top with Velcro. Our Lite Cushion has seamless features allowing it to highlight the fabric details. The result provides a modern and simple look.

The Lite Cushion is available in the following Grade A fabrics only: Fedora, Glint, Pebble, Rancho & Script

Select from our graded upholstery program of solid color fabrics and vinyl's or choose COM option (Customer Own Material). To determine if a COM fabric has been pre-approved for use on our cushion topper, contact your client services representative or log into INSITE. For application of ALL fabrics, both from our graded program as well as COM (Customer Own Material) please specify layout orientation at time of order. If layup instructions are not provided Inscape will choose the direction to maximize production. Refer to the diagram below for layup options.

After calculating the total amount of material needed in inches, divide the total number of inches by 36 for the total yardage and round up to the next full yard. Allow additional for repeat. Add 15% of total fabric required for small and medium pattern repeats. Add 20% of total fabric required for large patterns.

Due to the nature of the design and manufacture of our cushion, only approved fabrics will be accepted for application. For a description of the procedure required for COM fabric approval see sample 'Cushion COM Test Request' form found in the General Information section of this price list. This form can be downloaded from the Administration section of Insite or by contacting your client services representative for assistance.

All directional/patterned fabrics (Graded or COM) require cushion layup instructions with order placement. Depending on layup additional fabric may be required and upcharges may apply. If layup instructions are not provided the layup that maximizes the production yield will be chosen. (Refer to the layup diagrams)

**Please see Finishes section for COM calculator.**

## FABRIC LAY UP OF PEDESTAL CUSHIONS

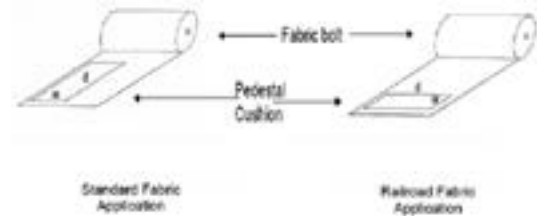

# Storage

## Pedestals

Storage with Handles Pedestals with Flat Glides

# System



- Consult General Information for pull options
- Includes worksurface mounting holes in top and bracket slots in back of case
- 15" letter width pedestal
- Worksurface supporting for 28.5" high

### OPTIONAL ACCESSORIES

All pedestal accessories are optional. See chart below for information an accessories by drawer height.

Drawer Height	Product Code	Product Description	Price
3" & 4.5"	PFWS-PTxx	Pencil Tray	\$37
6" & 7.5"	PFWS-PTxx	Pencil Tray	\$37
	PFWS-DVxx	Divider	\$22
18"D, 22"D, 28"D Pedestals Only (28"D requires 2 per drawer)			
10.5", 12", 13.5, & 15"	PFSSFxx	Side-To-Side Filing Bar	\$8

Visit the [Pedestal Accessories](#) section for full accessory details.

	Part number	H	W	D	Wt (lbs)	Neutral paint/ base price	Accent paint
 2-6" box, 12" file	<b>GHF1522-2BF</b>	26 7/8"	15"	22"	100	\$1023	+\$104
	<b>GHF1528-2BF</b>	26 7/8"	15"	28"	110	\$1077	+\$110
 2-12" files	<b>GHF1522-2F</b>	26 7/8"	15"	22"	100	\$899	+\$93
	<b>GHF1528-2F</b>	26 7/8"	15"	28"	110	\$927	+\$96
 3" pencil, 2-10.5" file	<b>GHF1522-P2F10</b>	26 7/8"	15"	22"	100	\$1023	+\$104
	<b>GHF1528-P2F10</b>	26 7/8"	15"	28"	110	\$1077	+\$110

# Storage

## Pedestals

### Storage with Handles Mobile Pedestals

# System

- Consult General Information for pull options
- 15" letter width pedestal
- Pedestals that include a cushion come with Classic Cushion
- For application of ALL fabrics, both from our graded program as well as COM (customers own material), please specify layup orientation at time of order. If layup instructions are not provided we will choose the direction to maximize our production. Refer to the Finishes Section for additional layout and COM details.

#### NOTES

In order to get a total cost on products when upcharges are present take the list price of the product number and add the upcharge cost shown to the list price.

For example:

Product PH1518-BFMCNH in Grade B/COM fabric would be \$1124 +\$57

PH1518-BFMCNH in Grade C fabric would be \$1124 +\$103 **OPTIONAL ACCESSORIES**



All pedestal accessories are optional. See chart below for information an accessories by drawer height.

Drawer Height	Product Code	Product Description	Price
3" & 4.5"	PFWS-PTxx	Pencil Tray	\$37
6" & 7.5"	PFWS-PTxx	Pencil Tray	\$37
	PFWS-DVxx	Divider	\$22

18"D, 22"D, 28"D Pedestals Only (28"D requires 2 per drawer)

Drawer Height	Product Code	Product Description	Price
10.5", 12", 13.5, & 15"	PFSSFxx	Side-To-Side Filing Bar	\$8

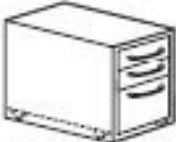
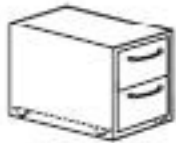
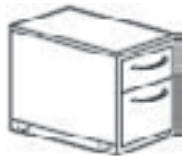
Visit the [Pedestal Accessories](#) section for full accessory details.

	Part number	H	W	D	Wt (lbs)	Neutral paint/ Grade A/ base price	Accent paint
 <p>2-6" box, 10.5" file Mobile No cushion</p>	PH1518-2BF10M	26"	15"	18"	85	\$1089	+\$111
	PH1522-2BF10M	26"	15"	22"	95	\$1207	+\$124
	PH1528-2BF10M	26"	15"	28"	105	\$1260	+\$129
 <p>10.5" file, 12" file Mobile No cushion</p>	PH1518-F10FM	26"	15"	18"	85	\$1018	+\$104
	PH1522-F10FM	26"	15"	22"	95	\$1089	+\$111
	PH1528-F10FM	26"	15"	28"	105	\$1118	+\$114
 <p>6" box, 12" file Mobile Includes cushion, no handle</p>	PH1518-BFMCNH	22 3/4"	15"	18"	90	\$1124	+\$115
	PH1522-BFMCNH	22 3/4"	15"	22"	100	\$1165	+\$119
	PH1528-BFMCNH	22 3/4"	15"	28"	105	\$1212	+\$125
 <p>7.5" box, 10.5" file Mobile Includes cushion, no handle</p>	PH1518B7F10MCNH	22 3/4"	15"	18"	90	\$1089	+\$111
	PH1522B7F10MCNH	22 3/4"	15"	22"	100	\$1212	+\$125
	PH1528B7F10MCNH	22 3/4"	15"	28"	105	\$1260	+\$129

#### FABRIC UPCHARGE FOR MOBILE CUSHION PEDESTALS - CLASSIC CUSHION OPTION ONLY

Note: To price fabric grade options, add the upcharge (+\$) in the chart below to the base price of the List price (Grade A) column.

This will be the total cost for that product.

Grade B/COM	Grade C	Grade D	Grade E	Grade F
+\$57	+\$103	+\$145	+\$174	+\$249

# Storage

## Pedestals

9900 Series Front Pedestals with Flat Glides

# System

- Includes worksurface mounting holes in top and bracket slots in back of case
- Worksurface supporting for 28.5" high
- Recommended installation below 1" worksurfaces only for clean aesthetic due to the tight corner radius of the worksurface

### OPTIONAL ACCESSORIES



All pedestal accessories are optional. See chart below for information an accessories by drawer height.

Drawer Height	Product Code	Product Description	Price
3" & 4.5"	PFWS-PTxx	Pencil Tray	\$37
6" & 7.5"	PFWS-PTxx	Pencil Tray	\$37
	PFWS-DVxx	Divider	\$22

18"D, 22"D, 28"D Pedestals Only (28"D requires 2 per drawer)

10.5", 12", 13.5, & 15"	PFSSFxx	Side-To-Side Filing Bar	\$8
-------------------------	---------	-------------------------	-----

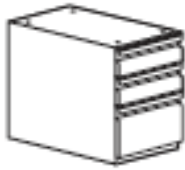
Visit the [Pedestal Accessories](#) section for full accessory details.

	Part number	H	W	D	Wt (lbs)	Neutral paint/ base price	Accent paint
 2-12" files Flat Glides	<b>GEF1522-2F</b>	26 7/8"	15"	22 3/4"	100	\$786	+\$94
	<b>GEF1528-2F</b>	26 7/8"	15"	28 3/4"	110	\$863	+\$98
	Letter Width						
 2-6" box, 1-12" file Flat Glides	<b>GEF1522-2BF</b>	26 7/8"	15"	22 3/4"	100	\$918	+\$105
	<b>GEF1528-2BF</b>	26 7/8"	15"	28 3/4"	110	\$1002	+\$111
	Letter Width						
 3" pencil, 2-10.5" files Flat Glides	<b>GEF1522-P2F10</b>	26 7/8"	15"	22 3/4"	100	\$930	+\$106
	<b>GEF1528-P2F10</b>	26 7/8"	15"	28 3/4"	110	\$1002	+\$111
	Letter Width						

# Storage

## Pedestals

### 9900 Series Front Pedestals with Rectangular Glides

# System

- Includes worksurface mounting holes in top and bracket slots in back of case
- Worksurface supporting for 28.5" high
- Recommended installation below 1" worksurfaces only for clean aesthetic due to the tight corner radius of the worksurface
- Rectangular glides are gray
- **Rectangular glides have an upcharge of \$29 per unit**

### OPTIONAL ACCESSORIES



All pedestal accessories are optional. See chart below for information an accessories by drawer height.

Drawer Height	Product Code	Product Description	Price
3" & 4.5"	PFWS-PTxx	Pencil Tray	\$37
6" & 7.5"	PFWS-PTxx	Pencil Tray	\$37
	PFWS-DVxx	Divider	\$22

18"D, 22"D, 28"D Pedestals Only (28"D requires 2 per drawer)

10.5", 12", 13.5, & 15"	PFSSFxx	Side-To-Side Filing Bar	\$8
-------------------------	---------	-------------------------	-----

Visit the [Pedestal Accessories](#) section for full accessory details.

	Part number	H	W	D	Wt (lbs)	Neutral paint/ base price	Accent paint
 10.5" File, 12" File Rectangular Glides	<b>INGE1522-F10F</b>	26 7/8"	15"	22 3/4"	95	\$914	+\$94
	<b>INGE1528-F10F</b> Letter Width	26 7/8"	15"	28 3/4"	105	\$950	+\$98
 2-6" box, 1-10.5" file Rectangular Glides	<b>INGE1522-2BF10</b>	26 7/8"	15"	22 3/4"	95	\$1036	+\$105
	<b>INGE1528-2BF10</b> Letter Width	26 7/8"	15"	28 3/4"	105	\$1086	+\$111
 3" pencil, 7.5" box, and 12" file Rectangular Glides	<b>INGE1522-PB7F</b>	26 7/8"	15"	22 3/4"	95	\$1038	+\$106
	<b>INGE1528-PB7F</b> Letter Width	26 7/8"	15"	28 3/4"	105	\$1090	+\$111

# Storage

## Pedestals

### 9900 Series Front Mobile Pedestals

# System

- 15" letter width mobile pedestals
- Pedestals that include a cushion have the option of Classic or Lite Cushion
- For application of ALL fabrics, both from our graded program as well as COM (customers own material), please specify layup orientation at time of order. If layup instructions are not provided we will choose the direction to maximize our production. Refer to the Finishes Section for additional layout and COM details.

#### NOTES

Optional face-mounted contemporary style handle available for mobile cushion pedestals, add \$32 list per pedestal. Handle is available in two finish options: Brushed Nickel (default) or Polished Nickel.

In order to get a total cost on products when upcharges are present take the list price of the product number and add the upcharge cost shown to the list price.

For example:

Product PF1518EBFMC in Grade B/COM fabric would be \$1002 +\$57  
 PF1518EBFMC in Grade C fabric would be \$1002 +\$103

All pedestal accessories are optional. See chart below for information on accessories by drawer height.

Drawer Height	Product Code	Product Description	Price
3" & 4.5"	PFWS-PTxx	Pencil Tray	\$37
6" & 7.5"	PFWS-PTxx	Pencil Tray	\$37
	PFWS-DVxx	Divider	\$22

18"D, 22"D, 28"D Pedestals Only (28"D requires 2 per drawer)

Drawer Height	Product Code	Product Description	Price
10.5", 12", 13.5, & 15"	PFSSFx	Side-To-Side Filing Bar	\$8

Visit the [Pedestal Accessories](#) section for full accessory details.

Part number	H	W	D	Wt (lbs)	Neutral paint/ Grade A/ base price	Accent paint
-------------	---	---	---	----------	--	-----------------



3" pencil, 6" box and 12" file  
No cushion

<b>PE1518-PBFM</b>	24 1/2"	15"	18 3/4"	85	\$975	+\$111
<b>PE1522-PBFM</b>	24 1/2"	15"	22 3/4"	95	\$1058	+\$121
<b>PE1528-PBFM</b>	24 1/2"	15"	28 3/4"	105	\$1141	+\$127



2-10.5" files  
No cushion

<b>PE1518-2F10.5M</b>	24 1/2"	15"	18 3/4"	85	\$1031	+\$105
<b>PE1522-2F10.5M</b>	24 1/2"	15"	22 3/4"	95	\$1100	+\$112
<b>PE1528-2F10.5M</b>	24 1/2"	15"	28 3/4"	105	\$1138	+\$116

Part number	H	W	D	Wt (lbs)	Classic Cushion/ Grade A/ Neutral paint/ base price	Lite Cushion/ Grade A only/ Neutral paint	Accent paint
-------------	---	---	---	----------	---	---	-----------------

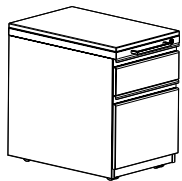

6" box, 12" file  
Includes cushion

<b>PF1518EBFMC</b>	22 3/4"	15"	18 3/4"	90	\$1002	-\$114	+\$116
<b>PF1522EBFMC</b>	22 3/4"	15"	22 3/4"	100	\$1058	-\$114	+\$121
<b>PF1528EBFMC</b>	22 3/4"	15"	28 3/4"	110	\$1125	-\$114	+\$126

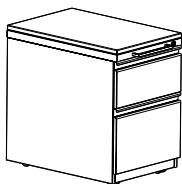

7.5" box, 10.5" file  
Includes cushion

<b>PF1518EB7F10MC</b>	22 3/4"	15"	18 3/4"	90	\$1002	-\$114	+\$116
<b>PF1522EB7F10MC</b>	22 3/4"	15"	22 3/4"	100	\$1058	-\$114	+\$121
<b>PF1528EB7F10MC</b>	22 3/4"	15"	28 3/4"	110	\$1125	-\$114	+\$126

#### FABRIC UPCHARGE FOR MOBILE CUSHION PEDESTALS - CLASSIC CUSHION OPTION ONLY

Note: To price fabric grade options, add the upcharge (+\$) in the chart below to the base price of the List price (Grade A) column. This will be the total cost for that product.

Grade B/COM	Grade C	Grade D	Grade E	Grade F
+\$57	+\$103	+\$145	+\$174	+\$249

# Storage

## Pedestals

### Nuform Front Pedestals with Flat Glides

# System

- Consult General Information for pull options
- Includes worksurface mounting holes in top and bracket slots in back of case
- 15" letter width pedestal
- Worksurface supporting for 28.5" high
- Nuform Classic and colors available

### OPTIONAL ACCESSORIES



All pedestal accessories are optional. See chart below for information an accessories by drawer height.

Drawer Height	Product Code	Product Description	Price
3" & 4.5"	PFWS-PTxx	Pencil Tray	\$37
6" & 7.5"	PFWS-PTxx	Pencil Tray	\$37
	PFWS-DVxx	Divider	\$22
<b>18"D, 22"D, 28"D Pedestals Only (28"D requires 2 per drawer)</b>			
10.5", 12", 13.5, & 15"	PFSSFxx	Side-To-Side Filing Bar	\$8

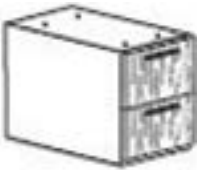
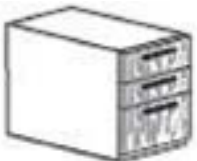
Visit the [Pedestal Accessories](#) section for full accessory details.



	Part number	H	W	D	Wt (lbs)	Nuform classic/ neutral paint/ base price	Nuform select	Accent paint
 2-12" files Flat Glides	<b>GQF1522-2F</b>	26 7/8"	15"	22 3/4"	95	\$1232	+\$137	+\$126
	<b>GQF1528-2F</b>	26 7/8"	15"	28 3/4"	105	\$1408	+\$157	+\$142
 2-6" box, 1-12" file Flat Glides	<b>GQF1522-2BF</b>	26 7/8"	15"	22 3/4"	95	\$1376	+\$153	+\$140
	<b>GQF1528-2BF</b>	26 7/8"	15"	28 3/4"	105	\$1510	+\$168	+\$153

- Pedestal brackets are full height and may be painted to match case finish
- The height is nominal and includes the thickness of the worksurface above the storage
- Specific brackets are required for case type and mounting application
- "2F" denotes use with 2 ¾" thick frame
- "3F" denotes use with 3 ½" thick frame
- Brackets are handed and are ordered based on which side of the frame the bracket is being mounted to

		Part number	H	Wt (lbs)	Neutral paint/ base price	Accent paint
	Full Height Pedestal Docking Bracket for Storage with Handles series and Nuform fronts For use with 3 ½" T frames Handed	<b>IN28.5PEDLH-3F</b>	28 ½"	2	\$92	+\$12
		left handed				
		<b>IN28.5PEDRH-3F</b>	28 ½"	2	\$92	+\$12
		right handed				
	Full Height Pedestal Docking Bracket for 9900 Series fronts For use with 3 ½" T frames Handed	<b>IN28.5PEDGLH-3F</b>	28 ½"	2	\$92	+\$12
		left handed				
		<b>IN28.5PEDGRH-3F</b>	28 ½"	2	\$92	+\$12
		right handed				
	Full Height Pedestal Docking Bracket for Storage with Handles Series and Nuform fronts For use with 2 ¾" T frames Handed	<b>IN28.5PEDLH-2F</b>	28 ½"	2	\$92	+\$12
		left handed				
		<b>IN28.5PEDRH-2F</b>	28 ½"	2	\$92	+\$12
		right handed				



- Pedestal brackets are full height and may be painted to match case finish
- The height is nominal and includes the thickness of the worksurface above the storage
- Specific brackets are required for case type and mounting application
- "2F" denotes use with 2 ¾" thick frame  
"3F" denotes use with 3 ½" thick frame
- Brackets are handed and are ordered based on which side of the frame the bracket is being mounted to

		Part number	H	Wt (lbs)	Neutral paint/ base price	Accent paint
	Full Height Pedestal Docking Bracket for 9900 Series fronts For use with 2 ¾" T frames Handed	<b>IN28.5PEDGLH-2F</b>	28 ½"	2	\$92	+\$12
		left handed				
		<b>IN28.5PEDGRH-2F</b>	28 ½"	2	\$92	+\$12
		right handed				
	Full Height Pedestal Docking Bracket for Storage with Handles Series and Nuform fronts For use with 1 ½" T screens Handed	<b>PEDBRKTLH</b>	28 ½"	2	\$48	+\$8
		left handed				
		<b>PEDBRKTRH</b>	28 ½"	2	\$48	+\$8
		right handed				
	Full Height Pedestal Docking Bracket for 9900 Series fronts For use with 1 ½" T screens Handed	<b>PEDBRKTLH</b>	28 ½"	2	\$48	+\$8
		left handed				
		<b>PEDBRKTRH</b>	28 ½"	2	\$48	+\$8
		right handed				

Lateral cabinets are of all-welded construction using 20 and 22 gauge high quality, tension leveled, and cold rolled steel. Drawer fronts, lift-up doors, roll-out shelves and all steel accessories are manufactured of the steel gauge appropriate to function at the highest quality level.

### **ANSI/BIFMA**

With the addition of counterweights where appropriate, cabinets meet all BIFMA specifications.

### **CONSTRUCTION FEATURES & BENEFITS**

All interiors are completely modular and interchangeable so that cabinets can be retrofitted with new accessories and interiors as required. Cabinet corners are welded at junction of top and case, eliminating horizontal lines for cleaner, flush appearance, and strengthened with reinforcing gussets. Double-wall construction allows lift-up doors to be picked up and receded smoothly, eliminates deformation, ensures flush fit within cabinet and improves lock performance. Lift-up door carrier mechanism has four nylon rollers two on each side - for smooth receding action with no binding or snagging. Self-closing, 110° opening, European style cupboard hinges for smooth door operations. Storage with Handles Series storage is single-wall construction.

The absence of scissor mechanism in doors and drawers eliminates the potential for scissors binding, and facilitates reconfiguration of cabinet openings as needed. Front leading edge of pullout shelves is beaded and rolled to provide grip for pullout action and strengthen shelf; front leading edge of fixed shelf is flat for easy removal of material. Fully progressive ball bearing suspension slides provide smooth action with minimum force.

Special "claw-like" device incorporated in suspension slide channel "grips" the fixed section of the suspension channel preventing drawer bounce-back or creep when drawer is closed. A patented Safelock™ interlock mechanism provides complete security and user safety against accidental opening of two or more drawers simultaneously. Lock fingers are configured with right angle bend upward not downward so that lift-up doors cannot be pulled down to disengage fingers from door slots and be forced to circumvent lock system. Lock bars operate vertically on both sides of cabinet for maximum security.

Laterals include 1 pair of hang file bars in 10.5" and 12" fixed fronts, 1 EDP kit in 13.5" and 15" fixed fronts, pencil tray in 3" multi-file drawer and steel divider in 7.5" multi-file drawer, steel divider in 6" multi-file drawers and 3 divider plates in 13.5" liftups. Fixed shelf in lift-up is slotted in 1" increments. Lateral-to-panel bracket is required if lateral is positioned on-module.

**NOTE: System storage laterals and multi-files consist of slots in the back of the case to allow for panel mounted brackets to be secured.**

### **COUNTERWEIGHTS**

Counterweights are required for ALL freestanding units that are not anchored or ganged to other cabinets or bolted to walls/floor. Counterweights come standard with ALL mobile pedestals and must be field installed.

### **DOCKING BRACKET**

The Lateral Docking Bracket docks a lateral to an Inscape System panel on-module. Specify bracket according to depth of worksurface and based on the thickness of panel. Counterweights are not required for laterals which are tied into the panel and worksurface supporting.

### **GLIDES**

Inscape System laterals are standard with flat glides. Glides provide 0.125" height adjustment when docked and 0.625" height adjustment if unit is not docked. 2 glides in front and 2 in back are adjustable from inside the cabinet so that cabinets can be leveled regardless of whether they are backed against a wall or banked.

### **LOCKS**

Standard with single bitted lock. If lock is not required add suffix '**NL**' after product number and deduct \$57 list per lock. For applications requiring higher security a double bitted solution is available. Random keying is standard, and keyed alike may be ordered. Master keys are available; refer to the accessories section to specify.

Cabinets originally ordered as non-locking may be field installed with the addition of locking bars and a lock core. Contact your client services representative for required parts.

Locks feature removable core and are standard with two keys, one of which has a black neoprene plastic key cover. Locks may be ordered for field installation. Specify cabinet height and width or model number.

**NOTE: Locks cannot be field installed on hinged door cabinets.**

## **STORAGE STABILIZER BRACKET**

Storage Stabilizer Bracket is specified when a storage case/Planna Storage lateral or pedestal is positioned directly adjacent to an Inscape System panel. This bracket does not create a gap between the case and the panel like a pedestal or lateral bracket does. No factory holes are required to be in the back of the case and are added at time of installation.

## **FINISHES**

All laterals are finished in standard 36.5° gloss baked enamel, electrostatically applied in a 2-coat process. Refer to Finishes section for available colors. With the exception of custom micas, whites and metallic; custom colors are available at an up-charge and are be subject to extended lead times. All interior drawers/shelf bodies, exposed hardware (excluding European style hinges) hang file bars, dividers and media frames are finished in Eco Black.

## **COM**

Select from our graded upholstery program of solid color fabrics and vinyl's or choose COM option (Customer Own Material). To determine if a COM fabric has been pre-approved for use on our cushion topper, contact your client services representative or log into INSITE. For application of ALL fabrics, both from our graded program as well as COM (Customer Own Material) please specify layout orientation at time of order. If layup instructions are not provided Inscape will choose the direction to maximize production. Refer to the diagram for layup options.

After calculating the total amount of material needed in inches, divide the total number of inches by 36 for the total yardage and round up to the next full yard. Allow additional for repeat. Add 15% of total fabric required for small and medium pattern repeats. Add 20% of total fabric required for large patterns.



Due to the nature of the design and manufacture of our cushion, only approved fabrics will be accepted for application. For a description of the procedure required for COM fabric approval see sample 'Cushion COM Test Request' form found in the General Information section of this price list. This form can be downloaded from the Administration section of Insite or by contacting your client services representative for assistance.

All directional/patterned fabrics (Graded or COM) require cushion layup instructions with order placement. Depending on layup additional fabric may be required and upcharges may apply. If layup instructions are not provided the layup that maximizes the production yield will be chosen. (Refer to the layup diagrams)

**Please see Finishes section for COM calculator.**

**FRONT DETAILS & PULL OPTIONS**

9900 Series fronts have full width integral pulls with enamel finish to match case fronts. Storage with Handles is single-wall construction. Refer to the images and chart below for pull application on Storage with Handles and Nuform fronts.

Pull	Storage with Handles	Nuform
 FP001 P290 Aluminum Leaf Finish	●	●
 FP004 Brushed Nickel Finish	●	●
 FP005 Brushed Nickel Finish	●	○

● Available    ○ Unavailable

Pulls FP004 and FP005 meet the guidelines for ADA compliance.

**FP005 is the default pull for Storage with Handles**  
**FP001 is the default pull for Nuform**



# Storage

## Laterals

Storage with Handles Laterals with Flat Glides

# System

- Includes slots in back for lateral to panel bracket, no holes on top
- Laterals are 18" deep
- Worksurface supporting for 28.5" high
- Consult General Information for pull options

		Part number	H	W	Wt (lbs)	Neutral paint/ base price	Accent paint
	3" pencil, 2-10.5" file Flat Glides	<b>GHF3024-P2F10</b>	26 7/8"	30"	105	\$1110	+\$114
		<b>GHF3624-P2F10</b>	26 7/8"	36"	125	\$1209	+\$124
		<b>GHF4224-P2F10</b>	26 7/8"	42"	135	\$1315	+\$133
	2-12" files Flat Glides	<b>GHF3024-FF</b>	26 7/8"	30"	105	\$927	+\$96
		<b>GHF3624-FF</b>	26 7/8"	36"	125	\$1020	+\$104
		<b>GHF4224-FF</b>	26 7/8"	42"	135	\$1123	+\$115







# Storage

## Laterals

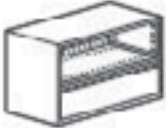
9900 Series Front Laterals with Flat Glides

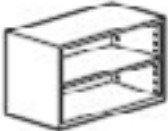
# System

- Includes slots in back for lateral to panel bracket, no holes on top
- Laterals are 18" deep
- Worksurface supporting for 28.5" high

		Part number	H	W	Wt (lbs)	Neutral paint/ base price	Accent paint
	13.5 bookcase Insert, 10.5" file Flat Glides	<b>GEF3024-BKF10</b>	26 7/8"	30"	100	\$1092	+\$111
		<b>GEF3624-BKF10</b>	26 7/8"	36"	125	\$1170	+\$120
		<b>GEF4224-BKF10</b>	26 7/8"	42"	135	\$1272	+\$130
	Display Cabinet Flat Glides	<b>GEF3024-2MS</b>	26 7/8"	30"	100	\$787	+\$83
		<b>GEF3624-2MS</b>	26 7/8"	36"	125	\$832	+\$87
		<b>GEF4224-2MS</b>	26 7/8"	42"	135	\$915	+\$94
	7.5" box, 16.5" bookcase insert Flat Glides	<b>GEF3024-B7BK</b>	26 7/8"	30"	98	\$1209	+\$124
		<b>GEF3624-B7BK</b>	26 7/8"	36"	108	\$1286	+\$131
		<b>GEF4224-B7BK</b>	26 7/8"	42"	121	\$1386	+\$140
	Bookcase with 1 shelf Flat Glides Adjustable or fixed shelf options	<b>GF3024-1BK18</b>	26 7/8"	30"	49	\$951	+\$98
		<b>GF3624-1BK18</b>	26 7/8"	36"	57	\$981	+\$101
		<b>GF4224-1BK18</b>	26 7/8"	42"	65	\$996	+\$102
	2-12" files Flat Glides	<b>GEF3024-FF</b>	26 7/8"	30"	105	\$1058	+\$111
		<b>GEF3624-FF</b>	26 7/8"	36"	125	\$1107	+\$123
		<b>GEF4224-FF</b>	26 7/8"	42"	135	\$1158	+\$134
	2-6" box, 12" file Flat Glides	<b>GEF3024-2BF</b>	26 7/8"	30"	105	\$1251	+\$128
		<b>GEF3624-2BF</b>	26 7/8"	36"	125	\$1372	+\$139
		<b>GEF4224-2BF</b>	26 7/8"	42"	135	\$1511	+\$153
	3" pencil, 2-10.5" files Flat Glides	<b>GEF3024-P2F10</b>	26 7/8"	30"	105	\$1305	+\$132
		<b>GEF3624-P2F10</b>	26 7/8"	36"	125	\$1423	+\$144
		<b>GEF4224-P2F10</b>	26 7/8"	42"	135	\$1547	+\$157
	13.5 lift up with Fixed Shelf, 10.5" file Flat Glides	<b>GEF3024-LUF10</b>	26 7/8"	30"	105	\$1091	+\$111
		<b>GEF3624-LUF10</b>	26 7/8"	36"	125	\$1205	+\$124
		<b>GEF4224-LUF10</b>	26 7/8"	42"	135	\$1333	+\$135



# Storage

## Laterals

9900 Series Front Laterals with Rectangular Glides

# System

- Includes slots in back for lateral to panel bracket, no holes on top
- Laterals are 18" deep
- Worksurface supporting for 28.5" high
- **Rectangular glides have an upcharge of \$29 per unit**

		Part number	H	W	Wt (lbs)	Neutral paint/ base price	Accent paint
	10.5" file, 12" file Rectangular Glides	<b>INGE3022.5-F10F</b>	25 ¼"	30"	—	\$1095	+\$111
		<b>INGE3622.5-F10F</b>	25 ¼"	36"	—	\$1200	+\$123
		<b>INGE4222.5-F10F</b>	25 ¼"	42"	—	\$1318	+\$134
	2-6" box, 10.5" file Rectangular Glides	<b>INGE3022.52BF10</b>	25 ¼"	30"	—	\$1251	+\$128
		<b>INGE3622.52BF10</b>	25 ¼"	36"	—	\$1384	+\$140
		<b>INGE4222.52BF10</b>	25 ¼"	42"	—	\$1511	+\$153
	3" pencil, 7.5" box ,12" file Rectangular Glides	<b>INGE3022.5-PB7F</b>	25 ¼"	30"	—	\$1123	+\$115
		<b>INGE3622.5-PB7F</b>	25 ¼"	36"	—	\$1228	+\$126
		<b>INGE4222.5-PB7F</b>	25 ¼"	42"	—	\$1344	+\$137



# Storage

## Laterals

### Nuform Front Laterals with Flat Glides



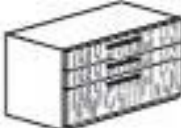



# System

- Includes slots in back for lateral to panel bracket, no holes on top
- Laterals are 18" deep
- Worksurface supporting for 28.5" high
- FP001 pull is standard. Consult General Information for pull options
- Nuform Classic and Select colors available



		Part number	H	W	Wt (lbs)	Nuform classic/ neutral paint/ base price	Nuform select	Accent paint
	2-12" files Flat Glides	<b>GQF3024-2FF</b>	26 7/8"	30"	95	\$1473	+\$164	+\$148
		<b>GQF3624-2FF</b>	26 7/8"	36"	105	\$1583	+\$175	+\$161
		<b>GQF4224-2FF</b>	26 7/8"	42"	115	\$1640	+\$182	+\$167
	2-6" box, 12" file Flat Glides	<b>GQF3024-2BF</b>	26 7/8"	30"	95	\$1773	+\$197	+\$180
		<b>GQF3624-2BF</b>	26 7/8"	36"	105	\$1892	+\$209	+\$192
		<b>GQF4224-2BF</b>	26 7/8"	42"	115	\$1976	+\$219	+\$200
	Nuform Front Hinged Door Cabinet with no interior accessories	<b>GQF3024HD</b>	26 7/8"	30"	75	\$1107	+\$124	+\$114
		<b>GQF3624HD</b>	26 7/8"	36"	95	\$1198	+\$133	+\$123
		<b>GQF4224HD</b>	26 7/8"	42"	110	\$1358	+\$152	+\$138
	Nuform Front Hinged Door Cabinet with 1 slotted shelf	<b>GQF3024HD-SH</b>	26 7/8"	30"	75	\$1207	+\$134	+\$124
		<b>GQF3624HD-SH</b>	26 7/8"	36"	95	\$1295	+\$144	+\$132
		<b>GQF4224HD-SH</b>	26 7/8"	42"	110	\$1458	+\$162	+\$147



- Lateral brackets are full height and may be painted to match case finish
- The height is nominal and includes the thickness of the worksurface above the storage
- Specific brackets are required for case type and for worksurfaces depth
- "2F" denotes use with 2 ¾" thick frame
- "3F" denotes use with 3 ½" thick frame
- Brackets are handed and are ordered based on which side of the frame the bracket is being mounted to

		Part number	H	Wt (lbs)	Neutral paint/ base price	Accent paint
	Full Height Lateral Docking Bracket for 24"D worksurfaces For Storage with Handles and 9900 series For use with 3 ½" T frames Handed	<b>IN28.5LBLH-3F</b> left handed	28 ½"	5	\$101	+\$13
		<b>IN28.5LBRH-3F</b> right handed	28 ½"	5	\$101	+\$13
	Full Height Lateral Docking Bracket for 24"D worksurfaces For GRID series For use with 3 ½" T frames Handed	<b>IN28.5LBGLH-3F</b> left handed	28 ½"	5	\$101	+\$13
		<b>IN28.5LBGRH-3F</b> right handed	28 ½"	5	\$101	+\$13
	Full Height Lateral Docking Bracket for 30"D worksurfaces For all series For use with 3 ½" T frames Handed	<b>IN28.5LB30LH-3F</b> left handed	28 ½"	5	\$131	+\$17
		<b>IN28.5LB30RH-3F</b> right handed	28 ½"	5	\$131	+\$17
	Full Height Lateral Docking Bracket for 24"D worksurfaces For Storage with Handles and 9900 Series For use with 2 ¾" T frames Handed	<b>IN28.5LBLH-2F</b> left handed	28 ½"	5	\$101	+\$13
		<b>IN28.5LBRH-2F</b> right handed	28 ½"	5	\$101	+\$13
	Full Height Lateral Docking Bracket for 24"D worksurfaces For GRID series For use with 2 ¾" T frames Handed	<b>IN28.5LBGLH-2F</b> left handed	28 ½"	5	\$101	+\$13
		<b>IN28.5LBGRH-2F</b> right handed	28 ½"	5	\$101	+\$13
	Full Height Lateral Docking Bracket for 30"D worksurfaces For all series For use with 2 ¾" T frames Handed	<b>IN28.5LB30LH-2F</b> left handed	28 ½"	5	\$131	+\$17
		<b>IN28.5LB30RH-2F</b> right handed	28 ½"	5	\$131	+\$17

- “2F” denotes use with 2 ¾" thick frame
- “3F” denotes use with 3 ½" thick frame
- Stabilizer brackets cannot be used with Modular Towers as they have chamfered corners

	Part number	Wt (lbs)	Neutral paint/ base price	Accent paint
 <p>Storage to Panel Stabilizer Bracket For use with 3 ½" T frames</p>	<b>INPSSB-3F</b>	1	\$48	+\$8
 <p>Storage to Panel Stabilizer Bracket For use with 2 ¾" T frames</p>	<b>INPSSB-2F</b>	1	\$48	+\$8

Workplace Towers are constructed of all-welded construction using high quality, tension leveled cold rolled steel. The steel gauge selected for drawer fronts, bodies and accessories ensure the highest quality durability and performance for all components.

### **SAFELOCK™**

The patented Safelock mechanism is standard on the 42" W locker and on towers and lockers that have more than one file (10.5" and 12") drawer. It provides complete security against accidental opening of two or more drawers simultaneously. When any drawer is extended, even fractionally, Safelock ensures that all other openings immediately become inoperable.

### **DRAWER STANDARD EQUIPMENT**

On pre-configured units, Lockers and towers containing 3" or 6" drawers are provided with one pencil tray per cabinet. 6" drawers are additionally standard with one steel divider. 10.5", 12" and 15" letter-width file drawers have one suspension bar for side-to-side filing of letter or legal-size folders. Full-width pullout drawers are standard with one pair hang file bars for side-to-side suspended filing. Full-width fixed shelves are standard with 3 plate dividers. Optional accessories are available. Build ups are ordered separately.

### **GLIDES**

Overall heights are inclusive of metal glides. Heights may be increased up to ¾" by extending the standard glide. Glides are accessible from inside the cabinet when the bottom drawer is fully extended or removed and may be adjusted with a 0.25" socket driver. Optional 1.5" stem glides are available.

### **LOCKS**

Standard with single bitted lock. If lock is not required add suffix '/NL' after product number and deduct \$57 list per lock. For applications requiring higher security a double bitted solution is available. Random keying is standard, and keyed alike may be ordered. Master keys are available; refer to the accessories section to specify.

Cabinets originally ordered as non-locking may be field installed with the addition of locking bars and a lock core. Contact your client services representative for required parts.

Locks feature removable core and are standard with two keys, one of which has a black neoprene plastic key cover. Locks may be ordered for field installation. Specify cabinet height and width or model number.

**Note: Locks cannot be field installed on hinged door cabinets.**

### **WARDROBE UNITS**

Freestanding wardrobe units are available in widths of 12", 15" and 18". The freestanding wardrobes match panel heights of 44", 51", 57" and 64" H. Wardrobe units are available in 9900 series, Nuform Classic and Select. Wardrobe units include the option of a coat rod and upper shelf or multiple shelves (quantities listed below)

44" H version includes 2 shelves

51" H version includes 2 shelves

57" H version includes 2 shelves

64" H version includes 3 shelves



Wardrobe units are locking and include flat glides on the freestanding versions.

### **FINISHES**

All towers are finished in standard 36.5° gloss baked enamel, electrostatically applied in a 2-coat process. Refer to the surface materials section for available colors. With the exception of custom micas, whites and metallic; custom colors are available at an up-charge and are be subject to extended lead times. All interior drawers/ shelf bodies, exposed hardware (excluding European style hinges) hang file bars, dividers and media frames are finished in Eco Black.

### FRONT DETAILS & PULL OPTIONS

9900 Series fronts have full width integral pulls with enamel finish to match case fronts. Storage with Handles is single-wall construction. Refer to the images and chart below for pull application on Storage with Handles and Nuform fronts.

Pull	Storage with Handles	Nuform
 <b>FP001</b> P290 Aluminum Leaf Finish	●	●
 <b>FP004</b> Brushed Nickel Finish	●	●
 <b>FP005</b> Brushed Nickel Finish	●	○

● Available    ○ Unavailable

Pulls FP004 and FP005 meet the guidelines for ADA compliance.

**FP005 is the default pull for Storage with Handles**

**FP001 is the default pull for Nuform**

# Storage

Towers  
9900 Series Front Workplace Towers

# System

- Towers are 24" deep
- Flat glides
- Glides which come standard with towers will level to lower than the actual frame height
- System glides are required to be ordered separately in order to match top of 64" H frame top trim

**CAUTION: Un-level floors may result in towers with leveling higher than the frame top trim**

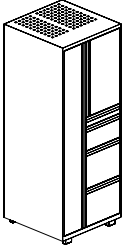
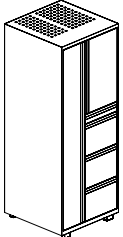
		Part number	H	W	Wt (lbs)	Neutral paint/ base price	Rectangular glides	Accent paint	
	Full-length door 14 1/4" wide on one side, 24" hinged door insert, 1-3" pencil, 1-7.5" box and 2-12" file drawers 13 5/8" wide on the other Optional Rectangular Glides	<b>GETL2458-PB7FF</b>	64"	24"	—	\$3691	+\$29	+\$371	
		<b>GETL3058-PB7FF</b>	64"	30"	—	\$4225	+\$29	+\$426	
		left-handed hinged door (illustrated)							
		<b>GETR2458-PB7FF</b>	64"	24"	—	\$3691	+\$29	+\$371	
	Full-length door 14 1/4" wide on one side, 24" hinged door insert, 1-3" pencil and 3-10.5" file drawers 13 5/8" wide on the other Optional Rectangular Glides	<b>GETL2458-P3F10</b>	64"	24"	—	\$3691	+\$29	+\$371	
		<b>GETL3058-P3F10</b>	64"	30"	—	\$4225	+\$29	+\$426	
		left-handed hinged door (illustrated)							
		<b>GETR2458-P3F10</b>	64"	24"	—	\$3691	+\$29	+\$371	
		<b>GETR3058-P3F10</b>	64"	30"	—	\$4225	+\$29	+\$426	
		right-handed hinged door							

- Option of mitten shelf with coat rod or shelves
- Use flat glides to match frame heights noted in descriptions
- Adding rectangular glides increases exterior height

**NOTES**

In order to get a total cost on products when upcharges are present take the list price of the product number and add the upcharge cost shown to the list price.

For example:

Product INVR121852E-HD with Rectangular Glides would be \$1524 +\$33

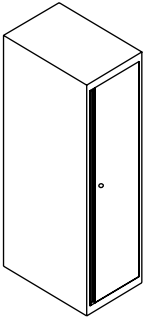
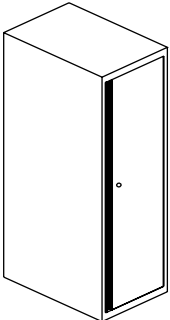
	Part number	H	W	D	Flat & Round Glides		Rectangular glides	Accent paint	
					Coat rod + shelf/ base price	Shelves			
 <p>9900 Series Wardrobe Tower to match 44" h panel</p>	<b>INVL121839E-HD</b>	41 7/8"	12"	18"	\$1295	\$1295	+\$29	+\$132	
	<b>INVL122439E-HD</b>	41 7/8"	12"	24"	\$1397	\$1397	+\$29	+\$141	
	<b>INVL151839E-HD</b>	41 7/8"	15"	18"	\$1397	\$1397	+\$29	+\$141	
	<b>INVL152439E-HD</b>	41 7/8"	15"	24"	\$1438	\$1438	+\$29	+\$145	
	<b>INVL181839E-HD</b>	41 7/8"	18"	18"	\$1438	\$1438	+\$29	+\$145	
	<b>INVL182439E-HD</b>	41 7/8"	18"	24"	\$1454	\$1454	+\$29	+\$146	
	left-handed hinged door								
	<b>INVR121839E-HD</b>	41 7/8"	12"	18"	\$1295	\$1295	+\$29	+\$132	
	<b>INVR122439E-HD</b>	41 7/8"	12"	24"	\$1397	\$1397	+\$29	+\$141	
	<b>INVR151839E-HD</b>	41 7/8"	15"	18"	\$1397	\$1397	+\$29	+\$141	
	<b>INVR152439E-HD</b>	41 7/8"	15"	24"	\$1438	\$1438	+\$29	+\$145	
	<b>INVR181839E-HD</b>	41 7/8"	18"	18"	\$1438	\$1438	+\$29	+\$145	
<b>INVR182439E-HD</b>	41 7/8"	18"	24"	\$1454	\$1454	+\$29	+\$146		
right-handed hinged door (illustrated)									
 <p>9900 Series Wardrobe Tower to match 51" h panel</p>	<b>INVL121846E-HD</b>	49 3/8"	12"	18"	\$1401	\$1401	+\$29	+\$142	
	<b>INVL122446E-HD</b>	49 3/8"	12"	24"	\$1479	\$1479	+\$29	+\$148	
	<b>INVL151846E-HD</b>	49 3/8"	15"	18"	\$1479	\$1479	+\$29	+\$148	
	<b>INVL152446E-HD</b>	49 3/8"	15"	24"	\$1562	\$1562	+\$29	+\$160	
	<b>INVL181846E-HD</b>	49 3/8"	18"	18"	\$1562	\$1562	+\$29	+\$160	
	<b>INVL182446E-HD</b>	49 3/8"	18"	24"	\$1645	\$1645	+\$29	+\$168	
	left-handed hinged door								
	<b>INVR121846E-HD</b>	49 3/8"	12"	18"	\$1401	\$1401	+\$29	+\$142	
	<b>INVR122446E-HD</b>	49 3/8"	12"	24"	\$1479	\$1479	+\$29	+\$148	
	<b>INVR151846E-HD</b>	49 3/8"	15"	18"	\$1479	\$1479	+\$29	+\$148	
	<b>INVR152446E-HD</b>	49 3/8"	15"	24"	\$1562	\$1562	+\$29	+\$160	
	<b>INVR181846E-HD</b>	49 3/8"	18"	18"	\$1562	\$1562	+\$29	+\$160	
<b>INVR182446E-HD</b>	49 3/8"	18"	24"	\$1645	\$1645	+\$29	+\$168		
right-handed hinged door (illustrated)									

- Option of mitten shelf with coat rod or shelves
- Use flat glides to match frame heights noted in descriptions
- Adding rectangular glides increases exterior height

**NOTES**

In order to get a total cost on products when upcharges are present take the list price of the product number and add the upcharge cost shown to the list price.

For example:

Product INVL121852E-HD with Rectangular Glides would be \$1524 +\$33

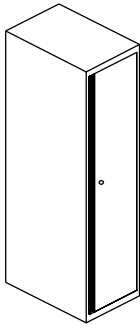
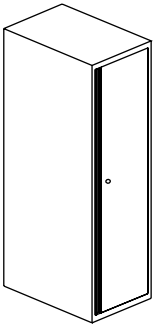
	Part number	H	W	D	Flat & Round Glides		Rectangular glides	Accent paint	
					Coat rod + shelf/ base price	Shelves			
 <p>9900 Series Wardrobe Tower to match 57" h panel</p>	<b>INVL121852E-HD</b>	55 3/8"	12"	18"	\$1524	\$1524	+\$29	+\$154	
	<b>INVL122452E-HD</b>	55 3/8"	12"	24"	\$1577	\$1577	+\$29	+\$161	
	<b>INVL151852E-HD</b>	55 3/8"	15"	18"	\$1577	\$1577	+\$29	+\$161	
	<b>INVL152452E-HD</b>	55 3/8"	15"	24"	\$1633	\$1633	+\$29	+\$167	
	<b>INVL181852E-HD</b>	55 3/8"	18"	18"	\$1633	\$1633	+\$29	+\$167	
	<b>INVL182452E-HD</b>	55 3/8"	18"	24"	\$1687	\$1687	+\$29	+\$171	
	left-handed hinged door								
	<b>INVR121852E-HD</b>	55 3/8"	12"	18"	\$1524	\$1524	+\$29	+\$154	
	<b>INVR122452E-HD</b>	55 3/8"	12"	24"	\$1577	\$1577	+\$29	+\$161	
	<b>INVR151852E-HD</b>	55 3/8"	15"	18"	\$1577	\$1577	+\$29	+\$161	
	<b>INVR152452E-HD</b>	55 3/8"	15"	24"	\$1633	\$1633	+\$29	+\$167	
	<b>INVR181852E-HD</b>	55 3/8"	18"	18"	\$1633	\$1633	+\$29	+\$167	
<b>INVR182452E-HD</b>	55 3/8"	18"	24"	\$1687	\$1687	+\$29	+\$171		
right-handed hinged door (illustrated)									
 <p>9900 Series Wardrobe Tower to match 64" h panel</p>	<b>INVL121860E-HD</b>	62 7/8"	12"	18"	\$1557	\$1557	+\$29	+\$159	
	<b>INVL122460E-HD</b>	62 7/8"	12"	24"	\$1645	\$1645	+\$29	+\$168	
	<b>INVL151860E-HD</b>	62 7/8"	15"	18"	\$1645	\$1645	+\$29	+\$168	
	<b>INVL152460E-HD</b>	62 7/8"	15"	24"	\$1692	\$1692	+\$29	+\$172	
	<b>INVL181860E-HD</b>	62 7/8"	18"	18"	\$1692	\$1692	+\$29	+\$172	
	<b>INVL182460E-HD</b>	62 7/8"	18"	24"	\$1739	\$1739	+\$29	+\$177	
	left-handed hinged door								
	<b>INVR121860E-HD</b>	62 7/8"	12"	18"	\$1557	\$1557	+\$29	+\$159	
	<b>INVR122460E-HD</b>	62 7/8"	12"	24"	\$1645	\$1645	+\$29	+\$168	
	<b>INVR151860E-HD</b>	62 7/8"	15"	18"	\$1645	\$1645	+\$29	+\$168	
	<b>INVR152460E-HD</b>	62 7/8"	15"	24"	\$1692	\$1692	+\$29	+\$172	
	<b>INVR181860E-HD</b>	62 7/8"	18"	18"	\$1692	\$1692	+\$29	+\$172	
<b>INVR182460E-HD</b>	62 7/8"	18"	24"	\$1739	\$1739	+\$29	+\$177		
right-handed hinged door (illustrated)									

- Option of mitten shelf with coat rod or shelves
- Use flat glides to match frame heights noted in descriptions
- Adding rectangular glides increases exterior height
- Consult General Information for pull options
- Nuform Classic and Select colors available
- Optional shelves or coat rod with shelf can be selected

**NOTES**

Nuform Wardrobes are available with an eLock option. Add \$411 to list price for eLock.

**eLocks come in two styles: Dead Bolt style or Slam style**

**There are two eLock types: Multi-use or Single-use**

In order to get a total cost on products when upcharges are present take the list price of the product number and add the upcharge cost shown to the list price.

For example:

Product INVR121852Q-HD with Rectangular Glides would be \$1829 +\$33

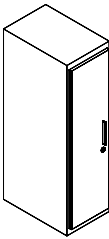
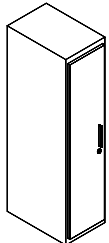
	Part number	H	W	D	Flat & Round Glides		Rectangular glides	Accent paint	
					Nuform classic/ Neutral paint	Nuform select/ Neutral paint			
 <p>Nuform Wardrobe Tower to match 44" h panel eLock option available</p>	<b>INVL121839Q-HD</b>	41 7/8"	12"	18"	\$1557	+\$172	+\$29	+\$159	
	<b>INVL122439Q-HD</b>	41 7/8"	12"	24"	\$1678	+\$185	+\$29	+\$171	
	<b>INVL151839Q-HD</b>	41 7/8"	15"	18"	\$1678	+\$185	+\$29	+\$171	
	<b>INVL152439Q-HD</b>	41 7/8"	15"	24"	\$1725	+\$192	+\$29	+\$175	
	<b>INVL181839Q-HD</b>	41 7/8"	18"	18"	\$1725	+\$192	+\$29	+\$175	
	<b>INVL182439Q-HD</b>	41 7/8"	18"	24"	\$1743	+\$194	+\$29	+\$177	
	left-handed hinged door								
	<b>INVR121839Q-HD</b>	41 7/8"	12"	18"	\$1557	+\$172	+\$29	+\$159	
	<b>INVR122439Q-HD</b>	41 7/8"	12"	24"	\$1678	+\$185	+\$29	+\$171	
	<b>INVR151839Q-HD</b>	41 7/8"	15"	18"	\$1678	+\$185	+\$29	+\$171	
	<b>INVR152439Q-HD</b>	41 7/8"	15"	24"	\$1725	+\$192	+\$29	+\$175	
	<b>INVR181839Q-HD</b>	41 7/8"	18"	18"	\$1725	+\$192	+\$29	+\$175	
<b>INVR182439Q-HD</b>	41 7/8"	18"	24"	\$1743	+\$194	+\$29	+\$177		
right-handed hinged door (illustrated)									
 <p>Nuform Wardrobe Tower to match 51" h panel eLock option available</p>	<b>INVL121846Q-HD</b>	49 3/8"	12"	18"	\$1683	+\$187	+\$29	+\$171	
	<b>INVL122446Q-HD</b>	49 3/8"	12"	24"	\$1774	+\$197	+\$29	+\$180	
	<b>INVL151846Q-HD</b>	49 3/8"	15"	18"	\$1774	+\$197	+\$29	+\$180	
	<b>INVL152446Q-HD</b>	49 3/8"	15"	24"	\$1871	+\$207	+\$29	+\$189	
	<b>INVL181846Q-HD</b>	49 3/8"	18"	18"	\$1871	+\$207	+\$29	+\$189	
	<b>INVL182446Q-HD</b>	49 3/8"	18"	24"	\$1975	+\$219	+\$29	+\$200	
	left-handed hinged door								
	<b>INVR121846Q-HD</b>	49 3/8"	12"	18"	\$1683	+\$187	+\$29	+\$171	
	<b>INVR122446Q-HD</b>	49 3/8"	12"	24"	\$1774	+\$197	+\$29	+\$180	
	<b>INVR151846Q-HD</b>	49 3/8"	15"	18"	\$1774	+\$197	+\$29	+\$180	
	<b>INVR152446Q-HD</b>	49 3/8"	15"	24"	\$1871	+\$207	+\$29	+\$189	
	<b>INVR181846Q-HD</b>	49 3/8"	18"	18"	\$1871	+\$207	+\$29	+\$189	
<b>INVR182446Q-HD</b>	49 3/8"	18"	24"	\$1975	+\$219	+\$29	+\$200		
right-handed hinged door (illustrated)									



- Option of mitten shelf with coat rod or shelves
- Use flat glides to match frame heights noted in descriptions
- Adding rectangular glides increases exterior height
- Consult General Information for pull options
- Nuform Classic and Select colors available
- Optional shelves or coat rod with shelf can be selected

**NOTES**

Nuform Wardrobes are available with an eLock option. Add \$411 to list price for eLock.

**eLocks come in two styles: Dead Bolt style or Slam style**

**There are two eLock types: Multi-use or Single-use**

In order to get a total cost on products when upcharges are present take the list price of the product number and add the upcharge cost shown to the list price.

For example:

Product INVR121852Q-HD with Rectangular Glides would be \$1829 +\$33

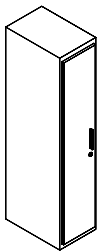

Nuform Wardrobe Tower to match 57" h panel

eLock option available

Part number	H	W	D	Flat & Round Glides		Rectangular glides	Accent paint
				Nuform classic/ Neutral paint	Nuform select/ Neutral paint		
<b>INVL121852Q-HD</b>	55 3/8"	12"	18"	\$1829	+\$202	+\$29	+\$185
<b>INVL122452Q-HD</b>	55 3/8"	12"	24"	\$1892	+\$209	+\$29	+\$192
<b>INVL151852Q-HD</b>	55 3/8"	15"	18"	\$1892	+\$209	+\$29	+\$192
<b>INVL152452Q-HD</b>	55 3/8"	15"	24"	\$1956	+\$216	+\$29	+\$198
<b>INVL181852Q-HD</b>	55 3/8"	18"	18"	\$1956	+\$216	+\$29	+\$198
<b>INVL182452Q-HD</b>	55 3/8"	18"	24"	\$2023	+\$223	+\$29	+\$205
left-handed hinged door							
<b>INVR121852Q-HD</b>	55 3/8"	12"	18"	\$1829	+\$202	+\$29	+\$185
<b>INVR122452Q-HD</b>	55 3/8"	12"	24"	\$1892	+\$209	+\$29	+\$192
<b>INVR151852Q-HD</b>	55 3/8"	15"	18"	\$1892	+\$209	+\$29	+\$192
<b>INVR152452Q-HD</b>	55 3/8"	15"	24"	\$1956	+\$216	+\$29	+\$198
<b>INVR181852Q-HD</b>	55 3/8"	18"	18"	\$1956	+\$216	+\$29	+\$198
<b>INVR182452Q-HD</b>	55 3/8"	18"	24"	\$2023	+\$223	+\$29	+\$205
right-handed hinged door (illustrated)							

- Option of mitten shelf with coat rod or shelves
- Use flat glides to match frame heights noted in descriptions
- Adding rectangular glides increases exterior height
- Consult General Information for pull options
- Nuform Classic and Select options available

**NOTES**

Nuform Wardrobes are available with an eLock option. Add \$411 to list price for eLock.

**eLocks come in two styles: Dead Bolt style or Slam style**

**There are two eLock types: Multi-use or Single-use**

In order to get a total cost on products when upcharges are present take the list price of the product number and add the upcharge cost shown to the list price.

For example:

Product INVR121860Q-HD with Rectangular Glides would be \$1868 +\$33

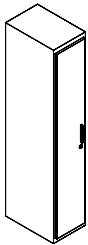

Nuform Wardrobe Tower to match 64" h panel

eLock option available

Part number	H	W	D	Flat & Round Glides		Rectangular glides	Accent paint
				Nuform classic/ Neutral paint	Nuform select/ Neutral paint		
<b>INVL121860Q-HD</b>	62 7/8"	12"	18"	\$1868	+\$207	+\$29	+\$189
<b>INVL122460Q-HD</b>	62 7/8"	12"	24"	\$1975	+\$219	+\$29	+\$200
<b>INVL151860Q-HD</b>	62 7/8"	15"	18"	\$1975	+\$219	+\$29	+\$200
<b>INVL152460Q-HD</b>	62 7/8"	15"	24"	\$2031	+\$225	+\$29	+\$206
<b>INVL181860Q-HD</b>	62 7/8"	18"	18"	\$2031	+\$225	+\$29	+\$206
<b>INVL182460Q-HD</b>	62 7/8"	18"	24"	\$2086	+\$232	+\$29	+\$211
left-handed hinged door							
<b>INVR121860Q-HD</b>	62 7/8"	12"	18"	\$1868	+\$207	+\$29	+\$189
<b>INVR122460Q-HD</b>	62 7/8"	12"	24"	\$1975	+\$219	+\$29	+\$200
<b>INVR151860Q-HD</b>	62 7/8"	15"	18"	\$1975	+\$219	+\$29	+\$200
<b>INVR152460Q-HD</b>	62 7/8"	15"	24"	\$2031	+\$225	+\$29	+\$206
<b>INVR181860Q-HD</b>	62 7/8"	18"	18"	\$2031	+\$225	+\$29	+\$206
<b>INVR182460Q-HD</b>	62 7/8"	18"	24"	\$2086	+\$232	+\$29	+\$211
right-handed hinged door (illustrated)							

## OVERHEAD STORAGE BINS

Overhead storage bins may be panel mounted on or off module as well as wall mounted. Overhead bins are fabricated from minimum 20 gauge steel with horizontal reinforcing channels. Task lights and bin-mounted sorters are easily installed beneath bins without tools. Bins are available in 6" increments from 24" to 48" W. General maximum recommended load for overhead bins is 3lbs per linear inch. Bins are finished in standard 37.5° gloss baked enamel, electrostatically applied in a 2-coat process and are available in all colors shown in the Inscope color guide.

Overhead bins are 13 3/8" deep and have lift-up flipper doors that glide on ball bearing slides. Soft-down bins feature a soft-down mechanism that slows the speed at which the overhead doors close. Bins are available with and without locks. The lock mechanism engages both sides of the overhead case to prevent forcible entry. Standard and soft-down overhead bins may be specified with Nuform fronts. Nuform fronts are available in any of Inscope's standard finishes.

## OVERHEAD BIN BRACKETS

Overhead bin brackets are finished in black and mount into the panel upright for on module bracket or utilize special brackets for off-module condition. Off-module brackets are specific to frame thickness. Specific Overhead Bin brackets are required for mounting onto a 44" and 57" H frame as well as 6.75" and 20.25" H stack-ons (on module).



On module bracket	Off-module
Both brackets attach into upright slots on upright	Both brackets are mounted off module only
Does not require tile behind	Must be further than 5/16" from module line
	Requires tile behind

## ALIGNMENT BRACKETS

Alignment brackets are required if overhead storage units are mounted bin-to-bin or bin-to-shelf or shelf-to-shelf. One bracket is required.

## TWIN-BINS

Twin-bins are 5.75" deep on each side of the supporting frame. Twin-Bins may be specified to install in both the lower and upper position of the frame. Bins are manufactured from minimum 20 gauge steel with an extruded aluminum reinforced top. Double wall, sliding doors on each side of the unit, slide easily across the recessed groove built into the bin front. Twin-Bins are available with or without locks. The locking mechanism is individualized for each side of the unit, allowing for personal privacy on either side. Twin-Bins are available in 36", 42", 48" and 60" widths. Recommended maximum load for Twin-Bins is 3lbs per linear inch. Bins are finished in standard 37.5° gloss baked enamel, electrostatically applied in a 2-coat process and are available in any of the colors shown in our Color Guide. Woodgrain fronts are available in any of our standard woodgrain finishes.

Handles are standard in aluminum finish and are located on the front of the sliding door. Case may still be ordered in any of the colors shown in our Color Guide.

## ELECTRIFIED TWIN BIN

The electrified twin bin is built on the same premise as the standard Twin Bin with the addition of electrical and a sliding door with locking capabilities in two positions. All electrical components are specified separately including power track, receptacles and jumper cables. The sliding door may lock either the binder storage portion (full depth of bin) or the electrified portion which is the center portion which is approximately 5" D. The back of the Electrified Twin Bin may be clad with either a tackboard or whiteboard which are both specific to this storage unit. A shelf may also be optioned for the electrified portion which is field installed midway between top and bottom of opening. A gap in the shelf allows for the cord of an electronic unit to plug into duplex (located near base of opening) and still sit on top of shelf.

**NOTE: these accessories are NOT compatible with the standard Twin Bin. See Application Guide for more details.**

Specify Twin-Bin mounting brackets separately according to location on frame. 1 bracket per Twin-Bin is required. Specify 13.5" high bottom tiles when lower position mounting bracket is specified. When stacking Twin-Bins a 6.75" high tile minimum must separate the two. Do not specify over Power Track Kit. Twin-Bins specified with 44" H frames cannot be used above a worksurface. It is not recommended to specify Twin-Bins on wing panels. Twin-Bins should only be specified on spine panels for adequate stability.

## OVERHEAD SHELVES

Overhead Shelves may be panel-mounted both on and off-module or wall-mounted. Shelves are manufactured from minimum 20 gauge steel. Shelves are 13.75" deep.

Task lights and shelf-mounted sorters may easily be installed beneath panel-mounted shelves without tools. General maximum recommended load for overhead shelves is 3 lbs. per linear inch. Shelves are finished in standard 37.5° gloss baked enamel, electrostatically applied in a 2-coat process.

## OVERHEAD SHELF BRACKETS

Overhead Shelf Brackets are specified to mount shelf on or off-module to the frame. The on-module bracket may be used with either thickness of panel. If a shelf is desired in an off-module condition a special bracket is required. Wall mount brackets are also available. Drywall mounting brackets do not include fasteners. The installer must ensure the surface is adequately constructed and/or braced and that adequate fasteners are used to ensure a secure installation.

## UP-MOUNT BIN

The Up-Mount Bin is constructed of 24 gauge steel on the back and 20 gauge steel on bottom, sides and top. The Up-Mount Bin is ordered and shipped independent of the stanchion kit, top trim and accessories to hang on back of bin. The stanchion kit includes hardware to mount the stanchions on the crossrail of the frame and top trim (tapered or flat). Stanchion kits are specified based on thickness of frame in which the Up-Mount Bin is being installed. The backs of all Up-Mount Bins require either a whiteboard or a tackboard to provide a clean aesthetic. These accessories are specific to the Up-Mount Bin and include mounting hardware. The stanchion and Up-Mount Bin provide an overall height of 20.25" module matching adjacent panel heights. The bin is 12.75" deep and may be specified directly adjacent to another Up-Mount Bin facing the opposite direction; creating a "Twin-Bin" effect. Separate top cap and two stanchions will be required for each bin.

The Up-Mount Bin has the option to also be mounted on either thickness of frame like a traditional bin. When this option is selected covers will be included to hide the bracket hooks.

## LOCKS

Standard with single bitted lock. If lock is not required add suffix '**NL**' after product number and deduct \$57 list per lock. For applications requiring higher security a double bitted solution is available. Random keying is standard, and keyed alike may be ordered. Master keys are available; refer to the accessories section to specify.

Cabinets originally ordered as non-locking may be field installed with the addition of locking bars and a lock core. Contact your client services representative for required parts.

Locks feature removable core and are standard with two keys, one of which has a black neoprene plastic key cover. Locks may be ordered for field installation. Specify cabinet height and width or model number.



**Note: Locks cannot be field installed on hinged door cabinets.**

## FINISHES

All overhead units are finished in standard 36.5° gloss baked enamel, electrostatically applied in a 2-coat process. Refer to the surface materials section for available colors. With the exception of custom micas, whites and metallic; custom colors are available at an up-charge and are subject to extended lead times. All interior drawers/ shelf bodies, exposed hardware (excluding European style hinges) hang file bars, dividers and media frames are finished in Eco Black.

### FRONT DETAILS & PULL OPTIONS

9900 Series fronts have full width integral pulls with enamel finish to match case fronts. Storage with Handles is single-wall construction. Refer to the images and chart below for pull application on Storage with Handles and Nuform fronts.

Pull	Storage with Handles	Nuform
 <b>FP001</b> P290 Aluminum Leaf Finish	●	●
 <b>FP004</b> Brushed Nickel Finish	●	●
 <b>FP005</b> Brushed Nickel Finish	●	○





● Available    ○ Unavailable

Pulls FP004 and FP005 meet the guidelines for ADA compliance.

**FP005 is the default pull for Storage with Handles**

**FP001 is the default pull for Nuform**

- Bracket ordered separately
- Ensure the wall is braced to accept the weight of a loaded overhead unit
- On module and aff module mounting options available
- Consult General Information for pull options
- Nuform Classic and Select options available
- Cannot span tiles below overhead bins

		Part number	H	W	Wt (lbs)	Nuform classic/ neutral paint/ base price	Nuform select	Accent paint
	Storage with Handles Standard Overhead Bin	<b>INPHHB24</b>	14"	24"	34	\$469	—	+\$50
		<b>INPHHB30</b>	14"	30"	40	\$480	—	+\$51
		<b>INPHHB36</b>	14"	36"	46	\$493	—	+\$52
		<b>INPHHB42</b>	14"	42"	52	\$523	—	+\$54
		<b>INPHHB48</b>	14"	48"	58	\$550	—	+\$58
	9900 Series Front Standard Overhead Bin	<b>INPHEB24</b>	14"	24"	34	\$550	—	+\$58
		<b>INPHEB30</b>	14"	30"	40	\$564	—	+\$59
		<b>INPHEB36</b>	14"	36"	46	\$579	—	+\$60
		<b>INPHEB42</b>	14"	42"	52	\$612	—	+\$63
		<b>INPHEB48</b>	14"	48"	58	\$648	—	+\$66
	9900 Series Front Soft- Down Overhead Bin	<b>INPHEB24SD</b>	14"	24"	34	\$678	—	+\$70
		<b>INPHEB30SD</b>	14"	30"	40	\$687	—	+\$70
		<b>INPHEB36SD</b>	14"	36"	46	\$712	—	+\$72
		<b>INPHEB42SD</b>	14"	42"	52	\$753	—	+\$77
		<b>INPHEB48SD</b>	14"	48"	58	\$794	—	+\$84
	Nuform Front Standard Overhead Bin	<b>INPHQB24</b>	14"	24"	34	\$783	+\$88	+\$83
		<b>INPHQB30</b>	14"	30"	40	\$795	+\$89	+\$84
		<b>INPHQB36</b>	14"	36"	46	\$822	+\$92	+\$86
		<b>INPHQB42</b>	14"	42"	52	\$870	+\$97	+\$90
		<b>INPHQB48</b>	14"	48"	58	\$915	+\$102	+\$94
	Nuform Front Soft-Down Overhead Bin	<b>INPHQB24SD</b>	14"	24"	34	\$829	+\$92	+\$87
		<b>INPHQB30SD</b>	14"	30"	40	\$858	+\$96	+\$89
		<b>INPHQB36SD</b>	14"	36"	46	\$885	+\$99	+\$91
		<b>INPHQB42SD</b>	14"	42"	52	\$913	+\$102	+\$94
		<b>INPHQB48SD</b>	14"	48"	58	\$943	+\$105	+\$97

- Bracket ordered separately
- Hinged door bin is for wall mounted application only
- Hinged Door Bin options Nuform and laminate come with a lock. Options glass and acrylic do not.
- Hinged door bins have a door that extends down a little bit below the bin so that it acts like a handle. No face mounted handle is required.
- Up-Mount Bin may be installed on a wall or panel using wall or panel brackets
- If the option to panel mount the Up-Mount Bin is selected cover will be included to hide the bracket hooks
- Optional colored insert available for Up-Mount bin only. See accessories section
- Optional top available for Up-mount bin only. See accessories section
- When the Up-Mount Bin is being mounted on a wall, the optional Flush Mount Kit can be installed on the bottom side of the bin to cover understructure typically used for stanchion mount. 54" and 60" Up-Mount Bins do not have this as a standard option.
- The Flush Mount Kit is not to be used when stanchion mounting to the bin
- Ensure the wall is braced to accept the weight of a loaded overhead unit

**LOCK OPTION**

Hinged Door Overhead Bins come standard with lock. If lock is not required as suffix"/NL" after product number. Deduct \$57 list per lock.

**NOTES**

Up-Mount Bins MUST always be specified to include a tack board or whiteboard specific to the up-mount bin width when installed on stanchion, as they cover holes on the back of the bin. See accessories section

If selecting the panel mounted option for the Up-Mount Bin, add \$108 list per bin.

In order to get a total cost on products when upcharges are present take the list price of the product number and add the upcharge cost shown to the list price.

For example:

Product INWMBHG24 in Grade 1 laminate would be \$1101 +\$355

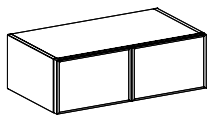



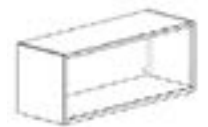

Hinged Door Bin

Part number	H	W	Nuform/ laminate/ base price	Grade 1 laminate	Pure white glass	Frosted acrylic	Flush bottom required	Accent paint
<b>INWMBHG24</b>	14"	24"	\$1101	+\$355	+\$469	+\$382	+\$112	+\$112
<b>INWMBHG30</b>	14"	30"	\$1161	+\$373	+\$515	+\$411	+\$116	+\$119

	Part number	H	W	Neutral paint/ base price	Flush bottom required	Accent paint
Up-Mount Bin	<b>INPHUMB24</b>	14"	24"	\$636	+\$112	+\$65
	<b>INPHUMB30</b>	14"	30"	\$657	+\$116	+\$67
	<b>INPHUMB36</b>	14"	36"	\$677	+\$120	+\$69
	<b>INPHUMB42</b>	14"	42"	\$709	+\$128	+\$72
	<b>INPHUMB48</b>	14"	48"	\$724	+\$134	+\$74
	<b>INPHUMB54</b>	14"	54"	\$755	—	+\$77
	<b>INPHUMB60</b>	14"	60"	\$829	—	+\$87



- Brackets are for use with both standard and soft-down bins
- On-module and off module brackets are black and ship as pairs
- Off-module brackets must be situated so both sides are off module on the frame (min 5/16" from module line)
- Wall mount bracket available in standard paint colors
- Alignment bracket must be specified when any overhead unit is specified adjacent to another
- "2F" denotes use with 2 3/4" thick frame
- "3F" denotes use with 3 1/2" thick frame
- Specific Overhead Bin brackets are required for mounting onto a 44" and 57" H frame as well as 6.75" and 20.25" H stack-ons (on module)

	Part number	W	Wt (lbs)	Neutral paint/ base price	Accent paint	
	On Module Overhead Bin Bracket	<b>INBBKT</b>	—	0.2	\$56	—
		<b>INBBKT-4457</b>	—	0.2	\$56	—
for use with 44" H & 57" H frames						
	Off Module Overhead Bin Bracket	<b>INOFBBKT-3F</b>	—	0.2	\$160	—
	For use with 3 1/2" T frames					
	Off Module Overhead Bin Bracket	<b>INOFBBKT-2F</b>	—	0.2	\$160	—
	For use with 2 3/4" T frames					
	Alignment Bracket (pair)	<b>INAB</b>	—	0.1	\$17	—
	Wall Mounted Bin Bracket	<b>INWMBBKT-24</b>	24"	2	\$263	+\$29
		<b>INWMBBKT-30</b>	30"	5	\$265	+\$29
		<b>INWMBBKT-36</b>	36"	5	\$267	+\$29
		<b>INWMBBKT-42</b>	42"	6	\$276	+\$30
		<b>INWMBBKT-48</b>	48"	6	\$279	+\$30







# Storage





## Overhead Storage Up-Mount Bin Supports and Brackets

# System

- Up-mount bins stanchions must be specified to support a frame mounted up-mount bin
- Top caps included with stanchion kits and are specified to match frame and bin width
- Stanchions are specific to the Inscape System frame and can not be used with Bench
- "2F" denotes use with 2 3/4" thick frame
- "3F" denotes use with 3 1/2" thick frame
- Specific Overhead Bin brackets are required for mounting onto a 44" and 57" H frame as well as 6.75" and 20.25" H stack-ons (on module)

	Part number	H	W	Wt (lbs)	Neutral paint/ base price	Accent paint	
	Stanchion Kit for Up-Mount Bins	<b>INUBSTNKT24-3F</b>	5 1/4"	24"	—	\$355	+\$37
	For use with 3 1/2" T frames	<b>INUBSTNKT30-3F</b>	5 1/4"	30"	—	\$367	+\$39
		<b>INUBSTNKT36-3F</b>	5 1/4"	36"	—	\$375	+\$42
		<b>INUBSTNKT42-3F</b>	5 1/4"	42"	—	\$386	+\$42
		<b>INUBSTNKT48-3F</b>	5 1/4"	48"	—	\$394	+\$43
		<b>INUBSTNKT54-3F</b>	5 1/4"	54"	—	\$405	+\$44
		<b>INUBSTNKT60-3F</b>	5 1/4"	60"	—	\$417	+\$45
	Stanchion Kit for Up-Mount Bins	<b>INUBSTNKT24-2F</b>	5 1/4"	24"	—	\$355	+\$37
	For use with 2 3/4" T frames	<b>INUBSTNKT30-2F</b>	5 1/4"	30"	—	\$367	+\$39
		<b>INUBSTNKT36-2F</b>	5 1/4"	36"	—	\$375	+\$42
		<b>INUBSTNKT42-2F</b>	5 1/4"	42"	—	\$386	+\$42
		<b>INUBSTNKT48-2F</b>	5 1/4"	48"	—	\$394	+\$43
		<b>INUBSTNKT54-2F</b>	5 1/4"	54"	—	\$405	+\$44
		<b>INUBSTNKT60-2F</b>	5 1/4"	60"	—	\$417	+\$45
	Part number	W	Wt (lbs)			List price	
	On Module Overhead Bin Bracket	<b>INBBKTUP-3F</b>	—	0.2		\$56	
	For use with the Up-Mount Bin on a 3 1/2" T frame	<b>INBBKTUP-3F4457</b>	—	0.2		\$56	
		for use with 44" H & 57" H frames					
	On Module Overhead Bin Bracket	<b>INBBKT</b>	—	0.2		\$56	
	For use with the Up-Mount Bin on a 2 3/4" T frame	<b>INBBKT-4457</b>	—	0.2		\$56	
		for use with 44" H & 57" H frames					
	Alignment Bracket (pair)	<b>INAB</b>	—	0.1		\$17	

- On-module brackets are painted and ship as pairs
- "2F" denotes use with 2 3/4" thick frame  
"3F" denotes use with 3 1/2" thick frame
- Alignment bracket must be specified when any shelf is specified adjacent to another

	Part number	H	W	Wt (lbs)	Neutral paint/ base price	Accent paint	
	13 3/8" D Standard Shelf	<b>INPS1324</b>	—	24"	4	\$72	+\$11
		<b>INPS1330</b>	—	30"	6	\$88	+\$12
		<b>INPS1336</b>	—	36"	8	\$92	+\$12
		<b>INPS1342</b>	—	42"	10	\$99	+\$13
		<b>INPS1348</b>	—	48"	12	\$103	+\$13
		<b>INPS1354</b>	—	54"	14	\$119	+\$15
		<b>INPS1360</b>	—	60"	16	\$128	+\$16
	On Module Standard Shelf Bracket For use with 3 1/2" T frames	<b>INSB13-3F</b>	—	—	3	\$146	+\$18
	On Module Standard Shelf Bracket For use with 2 3/4" T frames	<b>INSB13-2F</b>	—	—	3	\$146	+\$18
	Wall Mount Standard Shelf Bracket	<b>INSB1324W</b>	—	24"	7	\$305	+\$33
		<b>INSB1330W</b>	—	30"	8	\$310	+\$33
		<b>INSB1336W</b>	—	36"	8	\$315	+\$33
		<b>INSB1342W</b>	—	42"	9	\$319	+\$34
		<b>INSB1348W</b>	—	48"	9	\$323	+\$34
	Alignment Bracket (pair)	<b>INAB</b>	—	—	0.1	\$17	—

- Up-mount overhead bins MUST always be specified to include a tackboard or whiteboard specific to the up-mount bin width (cover holes in back) when mounted on stantions
- Overhead bin top is an optional aesthetic
- ¾" top is installation ready, complete with double sided tape for adhesion to case

**NOTE**

Only Expo Markers are to be used on any Inscape Whiteboard. Whiteboards should be cleaned with Expo Eraser or a Microfiber cleaning cloth along with Expo Cleaning Solution which is formulated to remove residue from Expo Dry Erase Markers.

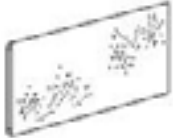

	Part number	H	W	Wt (lbs)	Neutral paint/ base price	Accent paint	
	Colored Insert for back of bin	<b>IN12INSRT24</b>	12 ½"	24"	—	\$104	+\$13
	For Up-Mounted bin only	<b>IN12INSRT30</b>	12 ½"	30"	—	\$108	+\$15
		<b>IN12INSRT36</b>	12 ½"	36"	—	\$116	+\$15
		<b>IN12INSRT42</b>	12 ½"	42"	—	\$121	+\$16
		<b>IN12INSRT48</b>	12 ½"	48"	—	\$128	+\$16

	Part number	H	W	Wt (lbs)	Neutral paint/ base price	Accent paint	
	Up-Mount Bin Whiteboard	<b>INUBWHB1424</b>	14"	24"	—	\$45	—
	<b>INUBWHB1430</b>	14"	30"	—	\$48	—	
	<b>INUBWHB1436</b>	14"	36"	—	\$52	—	
	<b>INUBWHB1442</b>	14"	42"	—	\$59	—	
	<b>INUBWHB1448</b>	14"	48"	—	\$65	—	
	<b>INUBWHB1454</b>	14"	54"	—	\$74	—	
	<b>INUBWHB1460</b>	14"	60"	—	\$77	—	

	Part number	H	W	Grade 1/ COM/ base price	Grade 2	Grade 3	Grade 4	Grade 5	Grade 6	Grade 7	Grade 8	
	Up-Mount Bin Tackboard	<b>INUBTAC1424</b>	14"	24"	\$171	+\$8	+\$12	—	+\$29	—	+\$74	—
	<b>INUBTAC1430</b>	14"	30"	\$195	+\$7	+\$12	—	+\$29	—	+\$77	—	
	<b>INUBTAC1436</b>	14"	36"	\$198	+\$12	+\$22	—	+\$44	—	+\$103	—	
	<b>INUBTAC1442</b>	14"	42"	\$204	+\$13	+\$23	—	+\$45	—	+\$106	—	
	<b>INUBTAC1448</b>	14"	48"	\$209	+\$13	+\$23	—	+\$48	—	+\$115	—	
	<b>INUBTAC1454</b>	14"	54"	\$212	+\$12	+\$25	—	+\$47	—	+\$114	—	
	<b>INUBTAC1460</b>	14"	60"	\$219	+\$10	+\$22	—	+\$46	—	+\$114	—	

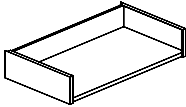

	Part number	W	D	Nuform classic/ base price	Nuform select pattern	
	¾" T Up-Mount Bin Top	<b>PHUMBTOP-1324</b>	24"	13"	\$159	+\$20
	<b>PHUMBTOP-1330</b>	30"	13"	\$187	+\$20	
	<b>PHUMBTOP-1336</b>	36"	13"	\$221	+\$17	
	<b>PHUMBTOP-1342</b>	42"	13"	\$245	+\$27	
	<b>PHUMBTOP-1348</b>	48"	13"	\$272	+\$30	
	<b>PHUMBTOP-1354</b>	54"	13"	\$299	+\$31	
	<b>PHUMBTOP-1360</b>	60"	13"	\$327	+\$34	
	<b>PHUMBTOP-1372</b>	72"	13"	\$429	+\$45	
	<b>PHUMBTOP-1384</b>	84"	13"	\$479	+\$48	
	<b>PHUMBTOP-1396</b>	96"	13"	\$526	+\$54	

- Up-Mount shelf mounts below the Up-Mount Bin on module
- Wall mount bracket available in standard paint colors
- Sliding door must be mounted on two up-mount bins of equal size that are side by side

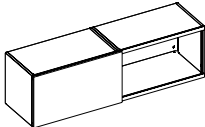





	Part number	H	W	Wt (lbs)	Neutral paint/ base price	Accent paint
	Up-Mount Bin shelf					
	<b>INUMBSH24</b>	4 1/8"	24"	—	\$304	+\$32
	<b>INUMBSH30</b>	4 1/8"	30"	—	\$310	+\$33
	<b>INUMBSH36</b>	4 1/8"	36"	—	\$315	+\$33
	<b>INUMBSH42</b>	4 1/8"	42"	—	\$344	+\$36
	<b>INUMBSH48</b>	4 1/8"	48"	—	\$355	+\$37
	Wall Mounted Bin Bracket					
	<b>INWMBBKT-24</b>	—	24"	2	\$263	+\$29
	<b>INWMBBKT-30</b>	—	30"	5	\$265	+\$29
	<b>INWMBBKT-36</b>	—	36"	5	\$267	+\$29
	<b>INWMBBKT-42</b>	—	42"	6	\$276	+\$30
	<b>INWMBBKT-48</b>	—	48"	6	\$279	+\$30

	Part number	W	Nufrom classic/ laminated/ base price	Nufrom select	Grade 1 laminated	Glass	Frosted acrylic
	Sliding Door & Track Up-Mount bin specified separately						
	<b>INUMBSLDR24</b>	24"	\$441	+\$50	+\$142	+400	+\$341
	<b>INUMBSLDR30</b>	30"	\$564	+\$63	+\$182	+428	+\$306
	<b>INUMBSLDR36</b>	36"	\$580	+\$65	+\$187	+522	+\$376
	<b>INUMBSLDR42</b>	42"	\$589	+\$66	+\$191	+625	+\$453
	<b>INUMBSLDR48</b>	48"	\$605	+\$67	+\$196	+720	+\$522

- Requires a 13.5" opening within either thickness of frame
- Twin-Bin cannot be installed directly above a worksurface as it causes interference
- Twin-Bin brackets are quoted separately and are specific to panel thickness
- Cannot span tiles below twin-bins
- Upperdeck electrical cannot be installed directly below a twin-bin
- Jumper cables and receptacles for the Electrified Twin Bin power track specified separately
- The "IN3D\_-UD-8" receptacles are to be specified in conjunction with the Electrified Twin-Bin

	Part number	H	W	Wt (lbs)	Nuform classic/ neutral paint/ base price	Nuform select	Accent paint	
	Nuform Front Twin-Bin	<b>INTWQB36LH</b>	14"	36"	42	\$1449	+\$161	+\$146
		<b>INTWQB42LH</b>	14"	42"	52	\$1506	+\$167	+\$153
		<b>INTWQB48LH</b>	14"	48"	58	\$1558	+\$172	+\$159
		<b>INTWQB54LH</b>	14"	54"	62	\$1576	+\$174	+\$161
		<b>INTWQB60LH</b>	14"	60"	68	\$1593	+\$177	+\$162
	Nuform Front Electrified Twin-Bin	<b>INETWBQ36</b>	14"	36"	42	\$1886	+\$209	+\$191
		<b>INETWBQ42</b>	14"	42"	52	\$1975	+\$219	+\$200
		<b>INETWBQ48</b>	14"	48"	58	\$2024	+\$225	+\$205
		<b>INETWBQ54</b>	14"	54"	62	\$2048	+\$227	+\$207
		<b>INETWBQ60</b>	14"	60"	68	\$2071	+\$229	+\$209

- The mid and lower brackets include crossrails which are required for installation of Twin-Bin
- Frame crossrail is required to be cut on site to install the mid Twin-Bin bracket
- See Inscape System Application Guide for bracket details and locations
- Twin-Bin brackets are specific to frame thickness
- "2F" denotes use with 2.75" thick frame,  
"3F" denotes use with 3.5" thick frame

		Part number	H	W	Wt (lbs)	List price
	Upper Twin-Bin Bracket For use with 3 1/2" T frames	<b>INTWBKT-U-3F</b>	—	—	0.4	\$114
	Mid Twin-Bin Bracket For use with 3 1/2" T frames	<b>INTWBKTUH-36-3F</b>	—	36"	—	\$178
		<b>INTWBKTUH-42-3F</b>	—	42"	—	\$180
		<b>INTWBKTUH-48-3F</b>	—	48"	—	\$183
		<b>INTWBKTUH-54-3F</b>	—	54"	—	\$185
		<b>INTWBKTUH-60-3F</b>	—	60"	—	\$188
	Lower Twin-Bin Bracket For use with 3 1/2" T frames	<b>INTWBKT-B-36-3F</b>	—	36"	—	\$178
		<b>INTWBKT-B-42-3F</b>	—	42"	—	\$180
		<b>INTWBKT-B-48-3F</b>	—	48"	—	\$183
		<b>INTWBKT-B-54-3F</b>	—	54"	—	\$185
		<b>INTWBKT-B-60-3F</b>	—	60"	—	\$188
	Upper Twin-Bin Bracket For use with 2 3/4" T frames	<b>INTWBKT-U-2F</b>	—	—	0.4	\$114
	Mid Twin-Bin Bracket For use with 2 3/4" T frames	<b>INTWBKTUH-36-2F</b>	—	36"	—	\$178
		<b>INTWBKTUH-42-2F</b>	—	42"	—	\$180
		<b>INTWBKTUH-48-2F</b>	—	48"	—	\$183
		<b>INTWBKTUH-54-2F</b>	—	54"	—	\$185
		<b>INTWBKTUH-60-2F</b>	—	60"	—	\$188
	Lower Twin-Bin Bracket For use with 2 3/4" T frames	<b>INTWBKT-B-36-2F</b>	—	36"	—	\$178
		<b>INTWBKT-B-42-2F</b>	—	42"	—	\$180
		<b>INTWBKT-B-48-2F</b>	—	48"	—	\$183
		<b>INTWBKT-B-54-2F</b>	—	54"	—	\$185
		<b>INTWBKT-B-60-2F</b>	—	60"	—	\$188

- Electrified Twin Bin shelf is installed in opening where electrical is located (center)
- Electrified Twin Bin Whiteboard + Tackboard only compatible with Electrified Twin Bin
- Receptacles are available in color options of black (default), white and gray
- White close match to 168 Glacier White and Gray close match to 290 – Aluminum Leaf
- The circuit 3 receptacle requires 2+2 or 3+1 wire designation ("4" in the code signifies 3+1 compatibility)
- USB power modules can be used with the Electrified Twin-Bin

**NOTE**

Only Expo Markers are to be used on any Inscape Whiteboard. Whiteboards should be cleaned with Expo Eraser or a Microfiber cleaning cloth along with Expo Cleaning Solution which is formulated to remove residue from Expo Dry Erase Markers.

Part number	H	W	Grade 1/ COM/ base price	Grade 2	Grade 3	Grade 4	Grade 5	Grade 6	Grade 7	Grade 8
 <b>INTWBTB-12</b>	14"	12"	\$130	+\$8	+\$16	—	+\$29	—	+\$74	—
<b>INTWBTB-14</b>	14"	14"	\$133	+\$8	+\$16	—	+\$29	—	+\$74	—
<b>INTWBTB-16</b>	14"	16"	\$139	+\$8	+\$16	—	+\$29	—	+\$74	—
<b>INTWBTB-18</b>	14"	18"	\$145	+\$8	+\$16	—	+\$29	—	+\$74	—
<b>INTWBTB-20</b>	14"	20"	\$159	+\$8	+\$16	—	+\$29	—	+\$74	—

Electrified Twin-Bin Tackboard

Part number	H	W	Wt (lbs)	Neutral paint/ base price	Accent paint	
 Electrified Twin-Bin Shelf	<b>INETWBSHF-12</b>	—	12"	—	\$105	+\$13
	<b>INETWBSHF-14</b>	—	14"	—	\$105	+\$13
	<b>INETWBSHF-16</b>	—	16"	—	\$105	+\$13
	<b>INETWBSHF-18</b>	—	18"	—	\$105	+\$13
	<b>INETWBSHF-20</b>	—	20"	—	\$105	+\$13

 Electrified Twin-Bin Whiteboard	<b>INTWBWB-12</b>	14"	12"	—	\$39	—
	<b>INTWBWB-14</b>	14"	14"	—	\$39	—
	<b>INTWBWB-16</b>	14"	16"	—	\$39	—
	<b>INTWBWB-18</b>	14"	18"	—	\$45	—
	<b>INTWBWB-20</b>	14"	20"	—	\$45	—

 Electrified Twin-Bin Power Track	<b>INETPTWB-8</b>	—	8"	—	\$88	—
--	-------------------	---	----	---	------	---

Part number	Black/ base price	White	Gray	
 Receptacle for use in Electrified Twin-Bin	<b>IN3D1-UD-8</b>	\$27	+\$11	+\$11
	<b>IN3D2-UD-8</b>	\$27	+\$11	+\$11
	<b>IN3D3-UD-8</b>	\$27	+\$11	+\$11
	<b>IN3D3U-UD-8</b>	\$27	+\$11	+\$11
	<b>IN3D4-UD-8</b>	\$27	+\$11	+\$11

Planna Storage exterior cabinet heights are nominal, interior case height is 21". Lateral and pedestal options are available. Units include mounting rails (see Inscape System Application Guide) that are pre-installed by the factory to accommodate the Planna Storage lateral top which is specified separately (see Accessories section). These mounting rails are ready to accept application of this lateral top on site. Bench support bracket must also be specified separately. Lateral cabinets are priced inclusive of one pair of hang file bars in each 10.5" and 12" pull out openings.

### **ANSI/BIFMA**

With the addition of counterweights where appropriate, cabinets meet all BIFMA specifications.

### **COUNTERWEIGHTS**

Counterweights are required for ALL freestanding units that are not anchored or ganged to other cabinets or bolted to walls/floor. Counterweights come standard with ALL mobile pedestals and must be field installed.

### **GLIDES**

Planna units are standard with flat glides. Glides allow for 3/8" height adjustability.

### **LOCKS**

Cabinets come standard with lock. 9900 series cabinets can be ordered non-locking. Bookcase cabinets come standard without locks. Standard with single bitted lock. If lock is not required add suffix 'N/L' after product number and deduct \$57 list per lock. For applications requiring higher security a double bitted solution is available. Random keying is standard, and keyed alike may be ordered. Master keys are available; refer to the accessories section to specify.

Cabinets originally ordered as non-locking may be field installed with the addition of locking bars and a lock core. Contact your client services representative for required parts.

Locks feature removable core and are standard with two keys, one of which has a black neoprene plastic key cover. Locks may be ordered for field installation. Specify cabinet height and width or model number.

**NOTE: Locks cannot be field installed on hinged door cabinets.**

**9900 Series Note: Pedestals with 9900 series fronts must be specified beneath 1" Nuform worksurfaces only.**



### **FINISHES**

All units are finished in standard 36.5° gloss baked enamel, electrostatically applied in a 2-coat process. Refer to the surface materials section for available colors. With the exception of custom micas, whites and metallic; custom colors are available at an up-charge and are be subject to extended lead times. All interior drawers/ shelf bodies, exposed hardware (excluding European style hinges) hang file bars, dividers and media frames are finished in Eco Black.



**FRONT DETAILS & PULL OPTIONS**

9900 Series fronts have full width integral pulls with enamel finish to match case fronts. Refer to the images and chart below for pull application on Nuform fronts.

Pull	Nuform
 FP001 P290 Aluminum Leaf Finish	●
 FP004 Brushed Nickel Finish	●
 FP005 Brushed Nickel Finish	○

● Available    ○ Unavailable

Pulls FP004 and FP005 meet the guidelines for ADA compliance.





**FP001 is the default pull for Nuform**

- Planna Storage case comes with optional Planna Storage rail
- **DO NOT option yes for rail if mounting a cushion on the case**
- **When "no rail" is optioned there will still be mounting holes in the top of the case. Cover with cushion or common top**
- 18"D lateral case
- Height noted below includes ½" Planna Storage rail.  
Adding a Planna common top will add an additional ½"
- FP001 pull is standard for Nuform fronts
- Consult General Information for pull options

**NOTE**

If Planna Storage rail is not required deduct the following:

- 30" W unit deduct \$157
- 36" W unit deduct \$162
- 42" W unit deduct \$168





		Part number	H	W	Wt (lbs)	Neutral paint/ base price	Accent paint
	Bookcase with 1 shelf	<b>PLN3021BK-SH</b>	24 ¾"	30"	59	\$1065	+\$108
		<b>PLN3621BK-SH</b>	24 ¾"	36"	69	\$1115	+\$114
		<b>PLN4221BK-SH</b>	24 ¾"	42"	79	\$1183	+\$121
	Bookcase with Electrical Cut Out	<b>PLN3021BKCO-SH</b>	24 ¾"	30"	59	\$1313	+\$133
		<b>PLN3621BKCO-SH</b>	24 ¾"	36"	69	\$1353	+\$138
		<b>PLN4221BKCO-SH</b>	24 ¾"	42"	79	\$1401	+\$142
	Bookcase with Electrical Cut Out and Drop Down Hinge Door	<b>PLN3021BKOPDM</b>	24 ¾"	30"	62	\$1518	+\$154
		<b>PLN3621BKOPDM</b>	24 ¾"	36"	72	\$1571	+\$160
		<b>PLN4221BKOPDM</b>	24 ¾"	42"	82	\$1635	+\$167
	Bookcase with Magazine Shelf	<b>PLN3021-SHMS</b>	24 ¾"	30"	59	\$1098	+\$112
		<b>PLN3621-SHMS</b>	24 ¾"	36"	69	\$1145	+\$118
		<b>PLN4221-SHMS</b>	24 ¾"	42"	79	\$1206	+\$124
	9900 Series Front 2-10.5" files	<b>PLN30-2F10E</b>	24 ¾"	30"	80	\$1252	+\$128
		<b>PLN36-2F10E</b>	24 ¾"	36"	90	\$1304	+\$132
		<b>PLN42-2F10E</b>	24 ¾"	42"	116	\$1353	+\$138

- Planna Storage case comes with optional Planna Storage rail
- **DO NOT option yes for rail if mounting a cushion on the case**
- **When "no rail" is optioned there will still be mounting holes in the top of the case. Cover with cushion or common top**
- 18" D lateral case
- Height noted below includes ½" Planna Storage rail. Adding a Planna common top will add an additional ½"
- FP001 pull is standard for Nuform fronts
- Consult General Information for pull options

**NOTE**

If Planna Storage rail is not required deduct the following:

- 30" W unit deduct \$157
- 36" W unit deduct \$162
- 42" W unit deduct \$168



		Part number	H	W	Wt (lbs)	Nuform classic/ neutral paint/ base price	Nuform select	Accent paint
	Nuform Front 2-10.5" files	<b>PLN30-2F10Q</b>	24 ¾"	30"	80	\$1551	+\$172	+\$159
		<b>PLN36-2F10Q</b>	24 ¾"	36"	90	\$1617	+\$179	+\$165
		<b>PLN42-2F10Q</b>	24 ¾"	42"	116	\$1683	+\$187	+\$171
	9900 Series Front 3" pencil, 6" box, 12" file	<b>PLN30-PBFE</b>	24 ¾"	30"	80	\$1388	—	+\$141
		<b>PLN36-PBFE</b>	24 ¾"	36"	90	\$1439	—	+\$145
		<b>PLN42-PBFE</b>	24 ¾"	42"	116	\$1489	—	+\$151
	9900 Series Front 3" pencil, 7.5" box, 10.5" file	<b>PLN30-PB7F10E</b>	24 ¾"	30"	80	\$1325	—	+\$134
		<b>PLN36-PB7F10E</b>	24 ¾"	36"	90	\$1381	—	+\$140
		<b>PLN42-PB7F10E</b>	24 ¾"	42"	116	\$1419	—	+\$143
	9900 Series Front 4.5" box, 6" box, 10.5" file	<b>PLN30-B4BF10E</b>	24 ¾"	30"	80	\$1325	—	+\$134
		<b>PLN36-B4BF10E</b>	24 ¾"	36"	90	\$1381	—	+\$140
		<b>PLN42-B4BF10E</b>	24 ¾"	42"	116	\$1419	—	+\$143

- Planna Storage case comes with optional Planna Storage rail
- **DO NOT option yes for rail if mounting a cushion on the case**
- **When "no rail" is optioned there will still be mounting holes in the top of the case. Cover with cushion or common top**
- 18"D lateral case
- Height noted below includes ½" Planna Storage rail. Adding a Planna common top will add an additional ½"
- FP001 pull is standard for Nuform fronts
- Consult General Information for pull options

**NOTE**

If Planna Storage rail is not required deduct the following:

- 30" W unit deduct \$157
- 36" W unit deduct \$162
- 42" W unit deduct \$168



		Part number	H	W	Wt (lbs)	Neutral paint/ base price	Accent paint
	9900 Series Front 6" box, bookcase	<b>PLN3021-BBKE</b>	24 ¾"	30"	70	\$1397	+\$141
		<b>PLN3621-BBKE</b>	24 ¾"	36"	85	\$1456	+\$146
		<b>PLN4221-BBKE</b>	24 ¾"	42"	100	\$1516	+\$154
	9900 Series Front Bookcase, 10.5" file	<b>PLN3021-BKF10E</b>	24 ¾"	30"	70	\$1382	+\$140
		<b>PLN3621-BKF10E</b>	24 ¾"	36"	90	\$1430	+\$144
		<b>PLN4221-BKF10E</b>	24 ¾"	42"	100	\$1489	+\$151
	9900 Series Front 3" pencil, bookcase	<b>PLN3021-PBKE</b>	24 ¾"	30"	70	\$1326	+\$134
		<b>PLN3621-PBKE</b>	24 ¾"	36"	85	\$1383	+\$140
		<b>PLN4221-PBKE</b>	24 ¾"	42"	100	\$1441	+\$145

- Planna Storage case comes with optional Planna Storage rail
- **DO NOT option yes for rail if mounting a cushion on the case**
- **When "no rail" is optioned there will still be mounting holes in the top of the case. Cover with cushion or common top**
- 18"D lateral case
- height noted below includes ½" Planna Storage rail. Adding a Planna common top will add an additional ½"
- FP001 pull is standard for acrylic, Nuform fronts
- Consult General Information for pull options

**NOTE**

If Planna Storage rail is not required deduct the following:

- 30" W unit deduct \$157
- 36" W unit deduct \$162
- 42" W unit deduct \$168

		Part number	H	W	Wt (lbs)	Nuform classic/ neutral paint/ base price	Nuform select	Accent paint
	9900 Series Front Hinged Door with 1 Shelf	<b>PLN3021HDE-SH</b>	24 ¾"	30"	57	\$1260	—	+\$129
		<b>PLN3621HDE-SH</b>	24 ¾"	36"	76	\$1273	—	+\$130
		<b>PLN4221HDE-SH</b>	24 ¾"	42"	95	\$1315	—	+\$133
	Frosted Acrylic Hinged Door with 1 Shelf	<b>PLN3021HDJ-SH</b>	24 ¾"	30"	57	\$2008	—	+\$204
		<b>PLN3621HDJ-SH</b>	24 ¾"	36"	76	\$2132	—	+\$215
		<b>PLN4221HDJ-SH</b>	24 ¾"	42"	95	\$2274	—	+\$229
	Nuform Front Hinged Door with 1 Shelf	<b>PLN3021HDQ-SH</b>	24 ¾"	30"	57	\$1489	+\$166	+\$151
		<b>PLN3621HDQ-SH</b>	24 ¾"	36"	76	\$1542	+\$171	+\$157
		<b>PLN4221HDQ-SH</b>	24 ¾"	42"	95	\$1595	+\$177	+\$162

- Planna Storage case comes with optional Planna Storage rail
- **DO NOT option yes for rail if mounting a cushion on the case**
- **When "no rail" is optioned there will still be mounting holes in the top of the case. Cover with cushion or common top**
- 15" W pedestal case
- Height noted below includes ½" Planna Storage rail. Adding a Planna common top will add an additional ½"
- FP001 pull is standard for Nuform fronts
- Consult General Information for pull options

**NOTE**

If Planna Storage rail is not required deduct the following:



- 18" D unit deduct \$152
- 22" D unit deduct \$157
- 28" D unit deduct \$162

**OPTIONAL ACCESSORIES**



All pedestal accessories are optional. See chart below for information an accessories by drawer height.

Drawer Height	Product Code	Product Description	Price
3" & 4.5"	PFWS-PTxx	Pencil Tray	\$37
6" & 7.5"	PFWS-PTxx	Pencil Tray	\$37
	PFWS-DVxx	Divider	\$22
<b>18"D, 22"D, 28"D Pedestals Only (28"D requires 2 per drawer)</b>			
10.5", 12", 13.5, & 15"	PFSSFxx	Side-To-Side Filing Bar	\$8

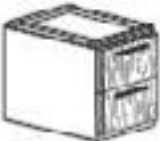



Visit the [Pedestal Accessories](#) section for full accessory details.

	Part number	H	W	Wt (lbs)	Nuform classic/ neutral paint/ base price	Nuform select	Accent paint
	9900 Series Front 2-10.5" files						
	<b>PLN1518E-2F10.5</b>	24 ¾"	18"	75	\$966	—	+\$99
	<b>PLN1522E-2F10.5</b>	24 ¾"	22"	85	\$1036	—	+\$105
	<b>PLN1528E-2F10.5</b>	24 ¾"	28"	95	\$1072	—	+\$108
	9900 Series Front 3" pencil, 6" box, 12" file						
	<b>PLN1518E-PBF</b>	24 ¾"	18"	75	\$1018	—	+\$104
	<b>PLN1522E-PBF</b>	24 ¾"	22"	85	\$1123	—	+\$115
	<b>PLN1528E-PBF</b>	24 ¾"	28"	95	\$1173	—	+\$120
	Nuform Front 2-10.5" file						
	<b>PLN1518Q-2F10.5</b>	24 ¾"	18"	75	\$1291	+\$143	+\$131
	<b>PLN1522Q-2F10.5</b>	24 ¾"	22"	85	\$1355	+\$151	+\$138
	<b>PLN1528Q-2F10.5</b>	24 ¾"	28"	95	\$1531	+\$170	+\$156

- Install on case where adjacent case is same width, allows for sliding door to cover both cases
- Sliding doors are handed and should be ordered based on direction of slide to open door
- Pull includes a 2" silver pull detail in upper quadrant of doors edge
- Sliding door must be mounted on two up-mount bins of equal size that are side by side

		Part number	H	W	Wt (lbs)	Neutral paint/ base price	Nuform select	Accent paint
	Nuform Classic Sliding Door	<b>SWBL3021SDS</b>	25 3/4"	30"	8	\$645	—	+\$66
		<b>SWBL3621SDS</b>	25 3/4"	36"	10	\$694	—	+\$71
		<b>SWBL4221SDS</b>	25 3/4"	42"	11	\$736	—	+\$76
		left-handed						
		<b>SWBR3021SDS</b>	25 3/4"	30"	8	\$645	—	+\$66
		<b>SWBR3621SDS</b>	25 3/4"	36"	10	\$694	—	+\$71
		<b>SWBR4221SDS</b>	25 3/4"	42"	11	\$736	—	+\$76
right-handed (illustrated)								
	Nuform Select Sliding Door	<b>SWBL3021SDQ</b>	25 3/4"	30"	8	\$645	+\$72	+\$66
		<b>SWBL3621SDQ</b>	25 3/4"	36"	10	\$694	+\$78	+\$71
		<b>SWBL4221SDQ</b>	25 3/4"	42"	11	\$736	+\$83	+\$76
		left-handed						
		<b>SWBR3021SDQ</b>	25 3/4"	30"	8	\$645	+\$72	+\$66
		<b>SWBR3621SDQ</b>	25 3/4"	36"	10	\$694	+\$78	+\$71
		<b>SWBR4221SDQ</b>	25 3/4"	42"	11	\$736	+\$83	+\$76
right-handed (illustrated)								

- Includes mounting hardware to attach to the adjacent Planna Storage cases
- 3.5" thick version only
- Specific for worksurface or cushion above
- Specific whether a cutout is required to allow electrical feed and data cabling to enter frame behind

		Part number	H	W	Wt (lbs)	Neutral paint/ base price	Accent paint
	End Trim with Electrical Cutout, Worksurface compatible (worksurface above)	<b>PLNCETCO</b>	25"	3.5"	2	\$91	+\$12
	End Trim without Cutout / Private Office Case Back Filler, Worksurface compatible (worksurface above)	<b>PLNCET</b>	25"	3.5"	2	\$88	+\$12
	End Trim with Electrical Cutout, Cushion compatible (cushion above)	<b>PLNCETCUSH</b>	25"	3.5"	2	\$73	+\$11
	End Trim without Cutout / Private Office Case Back Filler, Cushion compatible (cushion above)	<b>PLNCETCUSH</b>	25"	3.5"	2	\$69	+\$10
	6.75" H Painted Multi Access Tile for use with Planna Storage	<b>INPL6.75MAP30</b>	6.75"	30"	4	\$104	+\$13
		<b>INPL6.75MAP36</b>	6.75"	36"	5	\$107	+\$15
		<b>INPL6.75MAP42</b>	6.75"	42"	6	\$115	+\$15



Laminate Storage exterior cabinet heights are nominal and have an actual dimension of 23.858" from bottom of glide to top of case when the glide is at minimum position. The mobile pedestal is an exception to this dimension rule as it is 21.25". Lateral, pedestal, open bookcase, tower and overhead bin options are available.

### ANSI/BIFMA

With the addition of counterweights where appropriate, cabinets meet all BIFMA specifications.

### COUNTERWEIGHTS

Counterweights are required for ALL freestanding units that are not anchored or ganged to other cabinets or bolted to walls/floor. Mobile Pedestals have a fifth caster installed on front underside which works as anti-tip mechanism, eliminating requirement for counterweight

### GLIDES

Laminate units are standard with flat glides. Glides allow for 1 ¼" height adjustability.

### LOCKS

Lateral, pedestal, bookcase with drawers, hinged door overhead bin and tower cabinets come standard with lock. Open bookcase and open bin cabinets come standard without locks. Standard with single bitted lock in a Satin Chrome finish. For applications requiring higher security a double bitted solution is available. Random keying is standard, and keyed alike may be ordered. Master keys are available; refer to the accessories section to specify.

Locks feature removable core and are standard with two keys, one of which has a black neoprene plastic key cover. Specify cabinet height and width or model number.

### OVERHEAD BRACKETS

Overheads are wall mounted and brackets are included in the code. Wall mounting brackets do not include fasteners as they are dependent on the requirements of the wall type. The installer must ensure the surface is adequately constructed and/or braced and that adequate fasteners are used to ensure a secure installation.

### FINISHES

All storage cases are available in all of inscape's standard low pressure laminate options (MCC codes).

All fixed storage fronts are default as low pressure laminate (like the cases), and are mounted flush with the front of the top. Mobile pedestal fronts extend past the case top before sloping flush with the top of the case. High pressure laminate is available for storage fronts for an upcharge.

Standard edge banding is 2.5mm and compliments worksurface.

Refer to the Finishes Section of this price list for available colors.

### CUSHION MOBILE PEDESTALS

The Classic Cushion is 1 ¼" thick CAL 117 compliant polyurethane foam with a 2.2 lb/ft. density. This upholstered cushion is balanced with a 7/8" board and is attached to the pedestal top with heavy duty Velcro.

Select from our graded upholstery program of solid color fabrics and vinyl's or choose COM option (Customer's Own Material). To determine if a COM fabric has been pre-approved for use on our cushion topper, contact your client services representative or log into INSITE. For application of ALL fabrics, both from our graded program as well as COM (Customer Own Material) please specify layout orientation at time of order. If layout instructions are not provided Inscape will choose the direction to maximize production. Refer to the diagram for layout options.

After calculating the total amount of material needed in inches, divide the total number of inches by 36 for the total yardage and round up to the next full yard. Allow additional for repeat. Add 15% of total fabric required for small and medium pattern repeats. Add 20% of total fabric required for large patterns.

Due to the nature of the design and manufacture of our cushion, only approved fabrics will be accepted for application. For a description of the procedure required for COM fabric approval see sample 'Cushion COM Test Request' form found in the General Information section of this price list. This form can be downloaded from the Administration section of Insite or by contacting your client services representative for assistance.

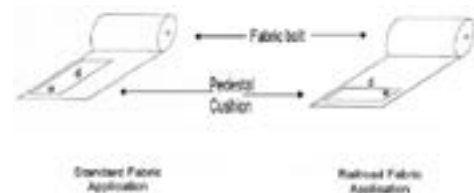

**Please see Finishes section for COM calculator.**

### FABRIC LAY UP OF PEDESTAL CUSHIONS



**FRONT DETAILS & PULL OPTIONS**

Laminate Storage offers flush fronts with surface mounted pulls. Refer to the images and chart below for pull application on Laminate Storage.

Pull	Laminate
 <b>FP001</b> P290 Aluminum Leaf Finish	●
 <b>FP004</b> Brushed Nickel Finish	●

- Available
- Unavailable

Pull FP004 meet the guidelines for ADA compliance.

**FP001 pull is the default pull for all Laminate Storage.**

- Mobile and fixed pedestal options available
- Both laminate pedestal options are locking
- Available pull options for Laminate Storage are FP001 and FP004 (default)
- Storage cases are available in any of Inscape's standard low pressure laminate options (MCC codes)
- Storage fronts are standard in any of Inscape's standard low pressure laminate options (MCC codes) but have the option to select a corresponding high pressure laminate for an upcharge
- Mobile Laminate Pedestals have an optional Classic cushion which is inset from the drawer fronts
- Fixed Laminate Pedestals must be used in a Hat Channel or a Rail Kit with common top application in order to support a worksurface at a 28.5" height
- Mobile pedestal has a caster at each corner and a single caster in the middle of the underside of the unit to make a total of 5 casters. The 5th caster acts as a counterweight.
- Laminate Storage exterior cabinet heights are nominal and have an actual dimension of 23.858" from bottom of glide to top of the case when the glide is at minimum position. The mobile pedestal is an exception to this dimension rule as it is 21.25" H.

- For application of ALL fabrics, both from our graded program as well as COM (customers own material), please specify layup orientation at time of order. If layup instructions are not provided we will choose the direction to maximize our production. Refer to the Finishes Section for additional layout and COM details.
- Models ordered with counter weights will be installed by default to the bottom shelf. When the counter weight is ordered separately it can field installed either on the bottom or the back of the unit.

**NOTES**

In order to get a total cost on products when upcharges are present take the list price of the product number and add the upcharge cost shown to the list price.

For example:

Product LL1518-BFMC in Grade B/COM fabric would be \$1101 +\$57LL1518-BFMC in Grade C fabric would be \$1101 +\$103

	Part number	Exterior Height	W	D	Wt (lbs)	Grade A/ base price	High pressure laminate front option	No cushion option
 <p>6" box, 12" file Laminate Mobile Pedestal Includes cushion</p>	<b>LL1518-BFMC</b>	22"	15 1/2"	18"	—	\$1101	+\$299	-\$227
	<b>LL1522-BFMC</b>	22"	15 1/2"	22"	—	\$1119	+\$309	-\$240

**FABRIC UPCHARGE FOR MOBILE PEDESTALS OPTIONED WITH CUSHION - CLASSIC CUSHION OPTION ONLY**

Note: To price fabric grade options, add the upcharge (+\$) in the chart below to the base price of the List price (Grade A) column. This will be the total cost for that product.

Grade B/COM	Grade C	Grade D	Grade E	Grade F
+\$57	+\$103	+\$145	+\$174	+\$249

	Part number	Exterior Height	W	D	Wt (lbs)	Base price	High pressure laminate front option
 <p>8" box, 12" file Laminate Pedestal no counterweight included</p>	<b>LL1518-BF</b>	24 3/8"	15 1/2"	18"	—	\$798	+\$247
	<b>LL1522-BF</b>	24 3/8"	15 1/2"	22"	—	\$837	+\$265
	<b>LL1528-BF</b>	24 3/8"	15 1/2"	28"	—	\$884	+\$283
<p>8" box, 12" file Laminate Pedestal counterweight included</p>	<b>LL1518-BFCW</b>	24 3/8"	15 1/2"	18"	—	\$972	+\$247
	<b>LL1522-BFCW</b>	24 3/8"	15 1/2"	22"	—	\$1009	+\$265
	<b>LL1528-BFCW</b>	24 3/8"	15 1/2"	28"	—	\$1051	+\$283

- Laterals are 18" deep and locking
- Available pull options for Laminate Storage are FP001 and FP004 (default)
- Storage cases are available in any of Inscape's standard low pressure laminate options (MCC codes)
- Storage fronts are standard in any of Inscape's standard low pressure laminate options (MCC codes) but have the option to select a corresponding high pressure laminate for an upcharge
- Mobile Laminate Laterals have an optional Classic cushion which is inset from the drawer fronts
- Mobile lateral has a caster at each corner and a single caster in the middle of the underside of the unit to make a total of 5 casters. The 5th caster acts as a counterweight.
- Laminate laterals must be used with a Hat Channel or a Rail Kit in order to support a worksurface at a 28.5" height
- Laminate Storage exterior cabinet heights are nominal and have an actual dimension of 23.858" from bottom of glide to top of bin when the glide is at minimum position

- File drawers are set up to accommodate both side to side or front to back filing Models ordered with counter weights will be installed by default to the bottom shelf. When the counter weight is ordered separately it can field installed either on the bottom or the back of the unit.

**NOTES**

In order to get a total cost on products when upcharges are present take the list price of the product number and add the upcharge cost shown to the list price.

For example:

Product LL24-BF with high pressure laminate fronts would be \$955 +\$242

	Part number	Exterior Height	W	D	Wt (lbs)	Base price	High pressure laminate front option
 <p>6" box, 12" file Laminate Mobile Lateral Includes cushion</p>	<b>LL2422-BFMC</b>	22"	24"	18"	—	\$1612	+\$260
	<b>LL3022-BFMC</b>	22"	30"	18"	—	\$1690	+\$283

**FABRIC UPCHARGE FOR MOBILE LATERALS OPTIONED WITH CUSHION - CLASSIC CUSHION OPTION ONLY**

Note: To price fabric grade options, add the upcharge (+\$) in the chart below to the base price of the List price (Grade A) column. This will be the total cost for that product.

Grade B/COM	Grade C	Grade D	Grade E	Grade F
+\$83	+\$148	+\$178	+\$216	+\$314

	Part number	Exterior Height	W	D	Wt (lbs)	Base price	High pressure laminate front option
 <p>8" box, 12" file Laminate Lateral no counterweight included</p>	<b>LL24-BF</b>	24 3/8"	24"	18"	—	\$955	+\$242
	<b>LL30-BF</b>	24 3/8"	30"	18"	—	\$1044	+\$260
	<b>LL36-BF</b>	24 3/8"	36"	18"	—	\$1087	+\$283
	<b>LL42-BF</b>	24 3/8"	42"	18"	—	\$1136	+\$303
<p>8" box, 12" file Laminate Lateral no counterweight included</p>	<b>LL24-BFCW</b>	24 3/8"	24"	18"	—	\$1132	+\$242
	<b>LL30-BFCW</b>	24 3/8"	30"	18"	—	\$1227	+\$260
	<b>LL36-BFCW</b>	24 3/8"	36"	18"	—	\$1257	+\$283
	<b>LL42-BFCW</b>	24 3/8"	42"	18"	—	\$1302	+\$303

- Bookcases are 18" deep
- Available pull options for Laminate Storage are FP001 and FP004 (default)
- Storage cases are available in any of Inscape's standard low pressure laminate options (MCC codes)
- Storage fronts are standard in any of Inscape's standard low pressure laminate options (MCC codes) but have the option to select a corresponding high pressure laminate for an upcharge
- Laminate Bookcases must be used with a Hat Channel or a Rail Kit in order to support a work surface at a 28.5" height
- Laminate Storage exterior cabinet heights are nominal and have an actual dimension of 23.858" from bottom of glide to top of bin when the glide is at minimum position





- Laminate Open Bookcase with electrical height adjustable cut out is to be used with freestanding tables. The cut out in the top surface will be raw and sealed with a clear varnish.

**NOTES**

In order to get a total cost on products when upcharges are present take the list price of the product number and add the upcharge cost shown to the list price.

For example:

Product LL2421BKCOPDM with high pressure laminate fronts would be \$1491 +\$227

		Part number	Exterior Height	W	D	Wt (lbs)	Base price	High pressure laminate front option	
	Laminate Open Bookcase with 1 adjustable shelf	<b>LL2421BK-SH</b>	24 3/8"	24"	18"	—	\$798	—	
		<b>LL3021BK-SH</b>	24 3/8"	30"	18"	—	\$866	—	
		<b>LL3621BK-SH</b>	24 3/8"	36"	18"	—	\$907	—	
		<b>LL4221BK-SH</b>	24 3/8"	42"	18"	—	\$969	—	
	Laminate Open Bookcase with 1 shelf and electrical cut out	<b>LL2421BKCO-SH</b>	24 3/8"	24"	18"	—	\$907	—	
		<b>LL3021BKCO-SH</b>	24 3/8"	30"	18"	—	\$981	—	
		<b>LL3621BKCO-SH</b>	24 3/8"	36"	18"	—	\$1050	—	
		<b>LL4221BKCO-SH</b>	24 3/8"	42"	18"	—	\$1090	—	
	Laminate Open Bookcase with 1 shelf and electrical cut out with drop down door	<b>LL2421BKCOPDM</b>	24 3/8"	24"	18"	—	\$1491	+\$227	
		<b>LL3021BKCOPDM</b>	24 3/8"	30"	18"	—	\$1548	+\$237	
		<b>LL3621BKCOPDM</b>	24 3/8"	36"	18"	—	\$1640	+\$242	
		<b>LL4221BKCOPDM</b>	24 3/8"	42"	18"	—	\$1709	+\$255	
	Laminate Open Bookcase with electrical height adjustable cut out	<b>LL2421BKHACOL</b>	24 3/8"	24"	18"	—	\$967	—	
		<b>LL3021BKHACOL</b>	24 3/8"	30"	18"	—	\$1043	—	
		left-handed (illustrated)							
		<b>LL2421BKHACOR</b>	24 3/8"	24"	18"	—	\$967	—	
		<b>LL3021BKHACOR</b>	24 3/8"	30"	18"	—	\$1043	—	
		right-handed							

- Combination Bookcase/Laterals are 18" deep and locking
- Available pull options for Laminate Storage are FP001 and FP004 (default)
- Storage cases are available in any of Inscape's standard low pressure laminate options (MCC codes)
- Storage fronts are standard in any of Inscape's standard low pressure laminate options (MCC codes) but have the option to select a corresponding high pressure laminate for an upcharge
- Laminate Combination Bookcase/Laterals must be used with a Hat Channel or a Rail Kit in order to support a worksurface at a 28.5" height
- Laminate Storage exterior cabinet heights are nominal and have an actual dimension of 23.858" from bottom of glide to top of bin when the glide is at minimum position
- File drawers are set up to accommodate both side to side or front to back filing



- Models ordered with counter weights will be installed by default to the bottom shelf. When the counter weight is ordered separately it can field installed either on the bottom or the back of the unit.

**NOTES**

In order to get a total cost on products when upcharges are present take the list price of the product number and add the upcharge cost shown to the list price.

For example:

Product LL2421-BKF with high pressure laminate fronts would be \$1125 +\$270

	Part number	Exterior Height	W	D	Wt (lbs)	Base price	High pressure laminate front option
 <p>Laminate Open Bookcase with 12" file drawer below no counterweight included</p>	<b>LL2421-BKF</b>	24 3/8"	24"	18"	—	\$1125	+\$270
	<b>LL3021-BKF</b>	24 3/8"	30"	18"	—	\$1166	+\$289
	<b>LL3621-BKF</b>	24 3/8"	36"	18"	—	\$1208	+\$308
	<b>LL4221-BKF</b>	24 3/8"	42"	18"	—	\$1295	+\$326
<p>Laminate Open Bookcase with 12" file drawer below counterweight included</p>	<b>LL2421-BKFCW</b>	24 3/8"	24"	18"	—	\$1304	+\$270
	<b>LL3021-BKFCW</b>	24 3/8"	30"	18"	—	\$1350	+\$289
	<b>LL3621-BKFCW</b>	24 3/8"	36"	18"	—	\$1375	+\$308
	<b>LL4221-BKFCW</b>	24 3/8"	42"	18"	—	\$1474	+\$326
 <p>Laminate Open Bookcase with 8" box drawer above no counterweight included</p>	<b>LL2421-BBK</b>	24 3/8"	24"	18"	—	\$1136	+\$167
	<b>LL3021-BBK</b>	24 3/8"	30"	18"	—	\$1181	+\$171
	<b>LL3621-BBK</b>	24 3/8"	36"	18"	—	\$1233	+\$189
	<b>LL4221-BBK</b>	24 3/8"	42"	18"	—	\$1295	+\$200
<p>Laminate Open Bookcase with 8" box drawer above counterweight included</p>	<b>LL2421-BBKCW</b>	24 3/8"	24"	18"	—	\$1325	+\$167
	<b>LL3021-BBKCW</b>	24 3/8"	30"	18"	—	\$1352	+\$171
	<b>LL3621-BBKCW</b>	24 3/8"	36"	18"	—	\$1413	+\$189
	<b>LL4221-BBKCW</b>	24 3/8"	42"	18"	—	\$1473	+\$200

- Hinged Door Cabinets are 18" deep and locking
- Available pull options for Laminate Storage are FP001 and FP004 (default)
- Storage cases are available in any of Inscape's standard low pressure laminate options (MCC codes)
- Storage fronts are standard in any of Inscape's standard low pressure laminate options (MCC codes) but have the option to select a corresponding high pressure laminate for an upcharge
- Laminate Hinged Door Cabinets must be used with a Hat Channel or a Rail Kit in order to support a worksurface at a 28.5" height
- Laminate Storage exterior cabinet heights are nominal and have an actual dimension of 23.858" from bottom of glide to top of bin when the glide is at minimum position

**NOTES**

In order to get a total cost on products when upcharges are present take the list price of the product number and add the upcharge cost shown to the list price.

For example:

Product LL2421HD-SH with high pressure laminate fronts would be \$1010 +\$218



Laminate Hinged Door Cabinet with 1 adjustable shelf

Part number	Exterior Height	W	D	Wt (lbs)	Base price	High pressure laminate front option
<b>LL2421HD-SH</b>	24 3/8"	24"	18"	—	\$1010	+\$218
<b>LL3021HD-SH</b>	24 3/8"	30"	18"	—	\$1051	+\$227
<b>LL3621HD-SH</b>	24 3/8"	36"	18"	—	\$1058	+\$242
<b>LL4221HD-SH</b>	24 3/8"	42"	18"	—	\$1092	+\$255

- Available pull options for Laminate Storage are FP001 and FP004 (default)
- Hinged Door option is locking, the open and sliding door overheads are non-locking
- Storage cases are available in any of Inscape's standard low pressure laminate options (MCC codes)
- Storage fronts are standard in any of Inscape's standard low pressure laminate options (MCC codes) but have the option to select a corresponding high pressure laminate for an upcharge
- Wall mount brackets included but fasteners are not as they are dependent on the requirements of the wall type
- Open Overhead Bins that are 36" w or larger will have a center divider that creates two openings
- Hinged Door Overhead Bins that are 36" w or larger will have a center divider and the unit will have four doors
- Ensure the wall is adequately constructed and/or braced and that adequate fasteners are used to ensure a secure installation.





- Shelf maximum weight capacity is 50lbs.
- Wall mounted brackets are included when specifying each overhead shelf
- Shelf is available in high pressure laminate and mounting brackets are painted
- Wall mounting brackets do not include fasteners as they are dependent on the requirements of the wall type

### NOTES

In order to get a total cost on products when upcharges are present take the list price of the product number and add the upcharge cost shown to the list price.

For example:

Product LLSDBIN-24 with high pressure laminate fronts would be \$872 +\$222

		Part number	Exterior Height	W	D	Wt (lbs)	Base price	High pressure laminate front option
	Laminate Overhead Open Bin	<b>LLOBIN-24</b>	14"	24"	15"	—	\$731	—
		<b>LLOBIN-30</b>	14"	30"	15"	—	\$795	—
		<b>LLOBIN-36</b>	14"	36"	15"	—	\$861	—
		<b>LLOBIN-42</b>	14"	42"	15"	—	\$927	—
		<b>LLOBIN-48</b>	14"	48"	15"	—	\$992	—
		<b>LLOBIN-54</b>	14"	54"	15"	—	\$1059	—
		<b>LLOBIN-60</b>	14"	60"	15"	—	\$1125	—
	Laminate Overhead Bin with one sliding door	<b>LLSDBIN-24</b>	14"	24"	15"	—	\$872	+\$222
		<b>LLSDBIN-30</b>	14"	30"	15"	—	\$947	+\$242
		<b>LLSDBIN-36</b>	14"	36"	15"	—	\$1021	+\$255
		<b>LLSDBIN-42</b>	14"	42"	15"	—	\$1096	+\$275
		<b>LLSDBIN-48</b>	14"	48"	15"	—	\$1170	+\$289
		<b>LLSDBIN-54</b>	14"	54"	15"	—	\$1245	+\$308
		<b>LLSDBIN-60</b>	14"	60"	15"	—	\$1319	+\$321
	Laminate Overhead Bin with hinged doors	<b>LLHDBIN-24</b>	14"	24"	15 3/4"	—	\$991	+\$209
		<b>LLHDBIN-30</b>	14"	30"	15 3/4"	—	\$1046	+\$227
		<b>LLHDBIN-36</b>	14"	36"	15 3/4"	—	\$1099	+\$242
		<b>LLHDBIN-42</b>	14"	42"	15 3/4"	—	\$1153	+\$260
		<b>LLHDBIN-48</b>	14"	48"	15 3/4"	—	\$1206	+\$275
		<b>LLHDBIN-54</b>	14"	54"	15 3/4"	—	\$1259	+\$293
		<b>LLHDBIN-60</b>	14"	60"	15 3/4"	—	\$1314	+\$308
	Laminate Overhead Open Shelf	<b>LLOOS-24</b>	6"	24"	12"	—	\$432	
		<b>LLOOS-30</b>	6"	30"	12"	—	\$486	
		<b>LLOOS-36</b>	6"	36"	12"	—	\$540	
		<b>LLOOS-42</b>	6"	42"	12"	—	\$621	
		<b>LLOOS-48</b>	6"	48"	12"	—	\$702	





- Available pull options for Laminate Storage are FP001 and FP004 (default)
- FP001 pull is not recommended for Manhattan Towers
- Storage cases are available in any of Inscape's standard low pressure laminate options (MCC codes)
- Storage fronts are standard in any of Inscape's standard low pressure laminate options (MCC codes) but have the option to select a corresponding high pressure laminate for an upcharge
- The Tower with 12" drawers offer front to back letter sized filing and do not have face mounted pulls.
- Interior accessory and shelf options differ slightly between height options for both tower types
- File drawers are set up to accommodate both side to side or front to back filing
- All Towers below include a coat hook

**NOTES**

In order to get a total cost on products when upcharges are present take the list price of the product number and add the upcharge cost shown to the list price.

For example:

Product LLMA2236-L with high pressure laminate fronts would be \$3098 +\$308

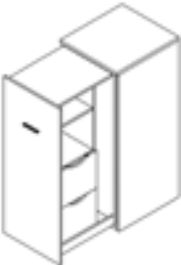
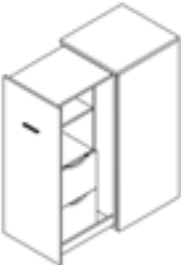
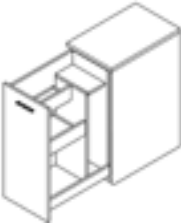
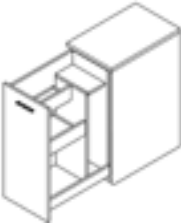
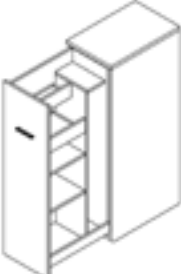
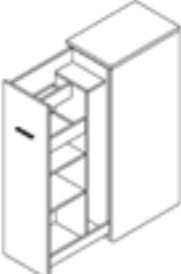

		Part number	Exterior Height	W	D	Wt (lbs)	Base price	High pressure laminate front option
	36"H Tower with 6" wardrobe on one side, 2-12" drawers with opening above on the other	<b>LLMA2236-L</b>	36"	22"	24"	—	\$3098	+\$308
		left handed (illustrated)						
		<b>LLMA2236-R</b>	36"	22"	24"	—	\$3098	+\$308
		right handed						
	54"H Tower with 6" wardrobe and 1 adjustable shelf on one side, 2-12" drawers with opening above and adjustable shelf on the other	<b>LLMA2254-L</b>	54"	22"	24"	—	\$3384	+\$308
		left handed (illustrated)						
		<b>LLMA2254-R</b>	54"	22"	24"	—	\$3384	+\$308
		right handed						
	36"H Slide Out Tower with wardrobe and multiple storage compartments Shelves are fixed height	<b>LLMB1536-L</b>	36"	15 1/2"	24"	—	\$2815	+\$308
		left handed (illustrated)						
		<b>LLMB1536-R</b>	36"	15 1/2"	24"	—	\$2815	+\$308
		right handed						
	54"H Slide Out Tower with wardrobe and multiple storage compartments Bottom two shelves are adjustable, top two are fixed height	<b>LLMB1554-L</b>	54"	15 1/2"	24"	—	\$3102	+\$308
		left handed (illustrated)						
		<b>LLMB1554-R</b>	54"	15 1/2"	24"	—	\$3102	+\$308
		right handed						

## Storage



Laminate Storage  
Accessories Trim and Connectors

# System

- End Filler Trim Includes mounting hardware to attach to the adjacent Laminate Storage cases
- End Filler Trim is available in any of Inscape's standard low pressure laminate options (MCC codes)
- Specific for cushion, common top or rail kit with common top above

		Part number	H	W	D	Wt (lbs)	List price
	Ganging Kit for Laminate Storage	<b>PFGK-L</b>	—	—	—	—	\$15
	End Filler Trim without Cutout To be used in a cushion, common top or rail kit with top application	<b>LLETNC</b>	25"	3 1/2"	—	—	\$133
	End Filler Trim with Cutout To be used in a cushion, common top or rail kit with top application	<b>LLETCO</b>	25"	3 1/2"	—	—	\$158

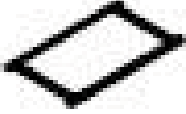
- Hat Channel heights are nominal and they support a standard worksurface height of 28.5"
- Hat Channels are available in any of Inscape's standard paint finishes
- Rail kits are optional on laminate cases, DO NOT specify if a cushion is to be installed
- Lateral kits install with the rail running the width of the case (side to side)
- Pedestal kits install with the rail running the depth of the case (front to back)
- Planna Storage Support Brackets are shipped as a pair and are both required worksurface installation

		Part number	H	W	D	Wt (lbs)	Neutral paint/ base price	Accent paint
	9"W x 3.363"H Hat Channel For use with Laminate Storage with no common top or rail kit	<b>HATCHNL3.363</b>	3 1/3"	9"	3"	2	\$52	+\$9
	Lateral Rail Kit with wood screws	<b>LL-KIT24</b>	—	24"	18"	5	\$157	+\$18
		<b>LL-KIT30</b>	—	30"	18"	5	\$161	+\$18
		<b>LL-KIT36</b>	—	36"	18"	6	\$166	+\$18
		<b>LL-KIT42</b>	—	42"	18"	6	\$171	+\$19
	Pedestal Rail Kit with wood screws	<b>LL-KIT15.518</b>	—	15 1/2"	18"	3	\$156	+\$17
		<b>LL-KIT15.522</b>	—	15 1/2"	22"	4	\$161	+\$18
		<b>LL-KIT15.528</b>	—	15 1/2"	28"	5	\$166	+\$18
	Planna Bracket (pair) Adjustable Height	<b>PSUPBKT</b>	—	—	—	1	\$92	+\$12

- Classic Cushions
- These cushions are specified and shipped separately from the case
- Velcro is included with the cushion for adhesion on the case
- Cushions are 1.25" thick and are to be specified with using only approved Upholstery standards from Inscape or COM
- For application of ALL fabrics, both from our graded program as well as COM (customers own material), please specify layup orientation at time of order. If layup instructions are not provided we will choose the direction to maximize our production. Refer to the Finishes Section for additional layout and COM details.

**NOTES**

In order to get a total cost on products when upcharges are present take the list price of the product number and add the upcharge cost shown to the list price.

For example:



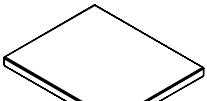

Product LLPEDCUSH1518SL in Grade C fabric would be \$275 +\$103

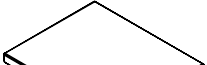
	Part number	H	W	D	Wt (lbs)	Grade A/ base price	Grade B/ COM	Grade C	Grade D	Grade E	Grade F
	<b>LLPEDCUSH1518SL</b>	1 ¼"	15 ½"	18"	—	\$275	+\$57	+\$103	+\$145	+\$174	+\$249
	<b>LLPEDCUSH1522SL</b>	1 ¼"	15 ½"	22"	—	\$281	+\$57	+\$103	+\$145	+\$174	+\$249
	<b>LLPEDCUSH1528SL</b>	1 ¼"	15 ½"	28"	—	\$291	+\$57	+\$103	+\$145	+\$174	+\$249

Cushion for  
Laminate Pedestal

	<b>LLPEDMCUSH1518</b>	1 ¼"	15 ½"	17.2"	—	\$275	+\$57	+\$103	+\$145	+\$174	+\$249
	<b>LLPEDMCUSH1522</b>	1 ¼"	15 ½"	21.2"	—	\$281	+\$57	+\$103	+\$145	+\$174	+\$249

Cushion for  
Laminate Mobile  
Pedestal

	Part number	W	D	Thickness	Laminate/ base price	Grade 1 laminate
 Pedestal Top	<b>LLN1518</b>	15"	18"	1/2"	\$90	+\$30
	<b>LLN1522</b>	15"	22"	1/2"	\$118	+\$39
	<b>LLN1528</b>	15"	28"	1/2"	\$144	+\$48
 Pedestal Top	<b>LLN15.518</b>	15 1/2"	18"	1/2"	\$90	+\$30
	<b>LLN15.222</b>	15 1/2"	22"	1/2"	\$118	+\$39
	<b>LLN15.528</b>	15 1/2"	28"	1/2"	\$144	+\$48
 18"D Single Depth Lateral Top	<b>LLN1830</b>	30"	18"	1/2"	\$156	+\$51
	<b>LLN1836</b>	36"	18"	1/2"	\$179	+\$59
	<b>LLN1842</b>	42"	18"	1/2"	\$204	+\$66
	<b>LLN1845</b>	45"	18"	1/2"	\$221	+\$72
	<b>LLN1845.5</b>	45 1/2"	18"	1/2"	\$221	+\$72
	<b>LLN1851</b>	51"	18"	1/2"	\$237	+\$77
	<b>LLN1851.5</b>	51 1/2"	18"	1/2"	\$237	+\$77
	<b>LLN1857</b>	57"	18"	1/2"	\$256	+\$85
	<b>LLN1857.5</b>	57 1/2"	18"	1/2"	\$256	+\$85
	<b>LLN1860</b>	60"	18"	1/2"	\$273	+\$89
	<b>LLN1866</b>	66"	18"	1/2"	\$296	+\$97
	<b>LLN1872</b>	72"	18"	1/2"	\$320	+\$103
	<b>LLN1878</b>	78"	18"	1/2"	\$344	+\$111
	<b>LLN1884</b>	84"	18"	1/2"	\$366	+\$119
	<b>LLN1890</b>	90"	18"	1/2"	\$393	+\$128
<b>LLN1896</b>	96"	18"	1/2"	\$408	+\$132	
 21"D Single Depth Lateral Top	<b>LLN2130</b>	30"	21"	1/2"	\$173	+\$57
	<b>LLN2136</b>	36"	21"	1/2"	\$198	+\$64
	<b>LLN2142</b>	42"	21"	1/2"	\$223	+\$73
	<b>LLN2145</b>	45"	21"	1/2"	\$240	+\$79
	<b>LLN2145.5</b>	45 1/2"	21"	1/2"	\$240	+\$79
	<b>LLN2151</b>	51"	21"	1/2"	\$262	+\$86
	<b>LLN2151.5</b>	51 1/2"	21"	1/2"	\$262	+\$86
	<b>LLN2157</b>	57"	21"	1/2"	\$279	+\$91
	<b>LLN2157.5</b>	57 1/2"	21"	1/2"	\$279	+\$91
	<b>LLN2160</b>	60"	21"	1/2"	\$300	+\$98
	<b>LLN2166</b>	66"	21"	1/2"	\$327	+\$105
	<b>LLN2172</b>	72"	21"	1/2"	\$223	+\$114
	<b>LLN2178</b>	78"	21"	1/2"	\$376	+\$123
	<b>LLN2184</b>	84"	21"	1/2"	\$400	+\$130
	<b>LLN2190</b>	90"	21"	1/2"	\$429	+\$139
<b>LLN2196</b>	96"	18"	1/2"	\$470	+\$152	

# System Accessories

**inscape**

work for tomorrow

Inscape System accessories include panel and table-mounted organizers, whiteboards, wall-mounted tack boards, panel mounted accessory shelves, pencil drawer, signage, a picture hook and coat hook. The panel and table-mounted organizers are easy to install, move and reconfigure and provide a comprehensive solution for effectively managing paper and other office supplies.

## HORIZONTAL ORGANIZERS

A variety of work tool Horizontal Organizers may be positioned at any point along the width of the paper management tiles. The three slat design allows for three different height options - customizing and providing adjustability to suit individual needs and preferences. Re-positioning the height of the trays can be easily done by lifting the trays out of the slats on the tile. Horizontal paper management accessories are available in colors shown in the Color Guide. These paper management organizers can withstand max 5lbs. The storage compartments are clear plastic.

## COAT HOOKS, PICTURE HOOKS AND SIGNAGE

Coat Hooks, Picture Hooks and Signage are manufactured from steel and snap onto panel crossrails without tools. Signage is available 9" W. The sign insert channel is 1" H. Insert is customer generated and can be printed on any printer compatible paper. Printing instructions are included. A strip of clear plastic slides into the channel to protect the printed identification card.

## PENCIL DRAWERS

Pencil Drawers can be installed under any Inscape System worksurface, increasing the amount of usable storage within the workstation.

## TOUCH UP PAINT

Touch Up Paint is available in ½ pint cans to repair minor scratches on trim, tiles and cabinets. Paint may also be specified in aerosol cans for any of our standard paint colors with the exception of mica and textured paint finishes. Custom enamel finishes are available in liquid only.

**NOTE: Restrictions may apply to shipping aerosol cans; contact your Client Services Representative.**

## CPU HOLDER

The CPU Holder mounts to the underside of any 1" or 1.25" thick worksurface. The AU200CU is non-locking and has a track size of 17". This CPU holder has a weight capacity of 13lbs. This CPU holder has a plastic glide track style. The AU300CU is non-locking with a weight capacity of 17lbs and has a track size of 17" with a ball bearing style track. All CPU holders have a height range of 14.5"/22.5" and a width range of 3.5"/9.3".

## WORKSURFACE STRETCHER BAR

Worksurface stretcher bar is additional structural support for unsupported worksurfaces of 54" or greater. It is 1 ½" H and the length of the stretcher bar is chosen based on the width of the worksurface. Be sure that there are no legs or panel mounted worksurface support brackets that may interfere with the stretcher bar.

## PANEL-MOUNTED WHITEBOARDS

Panel-Mounted Whiteboards are available in two tile heights and in five tile widths. They are manufactured from steel and are powder-coated with white paint specially formulated for dry erase markers.

**NOTE: Only Expo Markers are to be used on any Inscape Whiteboard. Whiteboards should be cleaned with Expo Eraser or a Microfiber cleaning cloth along with Expo Cleaning Solution which is formulated to remove residue from Expo Dry Erase Markers.**

## CROSSRAILS

Crossrails are available for order when a tile configuration requires a different mount of the tile from where crossrails are placed when shipped. These crossrails are based on the width of the panel as well as the thickness, either 2.75" or 3.5". Crossrails are shipped with mounting hardware as well as tile clips.

## MODESTY PANELS

Modesty Panels are available in a variety of options including painted, Nuform, laminate and acrylic. Panels are available in Partial Height of 13.5" and Full Height of 24" versions and a number of widths. Calculations must be made to determine the correct width dimension of Modesty Panel should be specified to accommodate the desired space. All mounting hardware is included in the product code and are installed on-site.

## TABLE MOUNTED FABRIC SCREEN

The Table Mounted Fabric Screen is constructed of a 1.5" thick extruded aluminum frame and is designed to provide modesty and privacy to adjacent work areas. This 37" H screen mounts onto a 1" or 1.25" thick worksurface and may be adjusted vertically to create the desired privacy or modesty. The tackable 0.5" thick core may be specified in any of Inscape's standard fabrics or COM. Height adjustable brackets allow for various screen height positions. It is recommended that the table mounted screen be installed 20" above the surface with 16" below. Table mounted screens cannot be attached at 90° connections to 3.5" thick frames.

## TABLE MOUNTED ACRYLIC SCREENS

Table Mounted Acrylic Screens ship with standoff hardware to mount to a 1" or a 1.25" thick work surface. The acrylic is a white finish with pre-drilled holes. When mounted, the screen extends 15.5" above the work surface. Mounting hardware is included within the kit.

## FREESTANDING TABLE SCREENS

The Freestanding Side Screen acts as a portable or stationary screen that separates two spaces adjacent to one another. The screen is made of 6mm thick frosted acrylic which is 13" H, seated in a painted aluminum extrusion, which can be painted any of Inscape's standard colors. The width of the screens is such that they are 5" less than the depth of our standard work surfaces.

## ADD-ON GLAZING

Add-on Glazing is manufactured from 1/4" tempered glass. A 3/8" tempered glass is also available. Glazing may be mounted to the top of any equivalent Inscape System frame or combination of frames outlined in the Application Guide. Glazing is available in clear, gray, etched one or two sides and designer glass Strie options. Add-on Glazing includes top trim, glass mounting extrusion and specified glass. Add-on Glazing is specified based on the thickness of the panel.

**NOTE: Hi-lo Add-on Glazing must be specified when installed directly adjacent to a higher panel at an inline situation only. The glaze and extrusion are inset on one side to allow for hi-lo vertical trim on the adjacent higher panel. If the situation calls for hi-lo on both sides, a special may be required. An Add-on Glazing alignment clip is included with each Add-on Glaze ordered.**

## WALL MOUNTED ACCESSORIES

Wall Mounted Accessories include tackboards, whiteboards and paper management rails. These accessories ship with mounting hardware and instructions on how to install them onto the wall. Re-enforcing of the wall should be taken into account when wall mounting any accessory for additional weight. Tackboards may be specified with any of our standard fabrics or a COM all are applied railroad orientation. The paper management rail may be specified with any of the colors found in the Color Guide.

Bin/Shelf-Mounted sorters install beneath overhead bins and shelves and hold literature, correspondence, notes, etc. Sorters are available in right and left-handed models and are easily repositioned by sliding horizontally along the length of the bin or shelf. Sorters ship in packages of three and may be painted in any of Inscape's color options. Bin and shelf sorters are specific to the unit they are being mounted on. Sorters are suitable for paper literature. Sliding Dividers may be placed in the overhead bin within a channel and slid to divide binders and other literature.

## MAGNETIC WHITEBOARDS

Magnetic Whiteboards are available to mount on the side access tower. Available in 13.25" width only and two heights, the magnetic whiteboard is manufactured from steel and powder-coated with white paint formulated for use with dry-erase markers. Magnetic whiteboards include a 10.5" W marker tray.

**NOTE: Only Expo Markers are to be used on any Inscape Whiteboard. Whiteboards should be cleaned with Expo Eraser or a Microfiber cleaning cloth along with Expo Cleaning Solution which is formulated to remove residue from Expo Dry Erase Markers.**

## HANGFILE BARS

Hangfile Bars are shipped as a pair and are used for 10.5", 12", 13.5", 15" and 16.5" pullout shelves/drawers.

## INVIROMASS COUNTERWEIGHTS

Inviromass Counterweights for field installation "IMCW-30, IMCW-36 and IMCW-42" consist of one Inviromass plate and one retaining wire. These plates are to be field installed into lateral file cabinet by inserting the 30", 36" or 42" W retaining wire into holes in the left and right hand rear stripe's.

The "INCW" for field installation consists of two 24lbs steel plates. These are affixed to back interior of case using peel and stripe two way tape.

## SYSTEM CARE KITS

System Care Kits are panel thickness specific. Included in this care kit is the following: panel hook and latch assembly, 2-way 90° connectors, tile clips, end of line plugs, Dekko electrical clips, inline connector and trim clips.

## BACK PAINTED GLASS

Back Painted Glass is a 6mm tempered glass addition to the back of Planna Storage cases. This glass is installed on the back of the case with stand off assemblies and holes that are field drilled into the case. Glass is painted on one side and available in white. Mounting hardware included.



## **SUPERSTOR™ INSERTS**

SuperStor™ Inserts may be purchased independently of a storage unit and field installed using #10 self-drilling 'Tek' screws. The pre slotted back panel of the insert accepts SuperStor™ Trays which are available in any of Inscape's standard paint colors plus textured finishes. Trays must be specified separately and for ease of specification are sold in packages: standard trays - package of 6, small trays - package of 3. The 30" insert is slotted to accept 12 Standard Trays (2 pkgs) and 3 Small Trays (1 pkg), the 36" insert is slotted to accept 18 Standard Trays (3 pkgs) and the 42" insert is slotted to accept 18 Standard Trays (3 pkgs) and 3 Small Trays (1 pkg).

## **PLANNA SUPPORT BRACKET**

Planna support bracket is specified to be mounted on Planna rail and floats the worksurface off the bracket. Bracket is available in all standard paint colors. Bracket "snaps" into the rail without the need for tools. These are shipped as a pair and both must be installed per worksurface.

## **HAT CHANNEL**

Hat channels are used to support a worksurface off of a 21" ID Planna storage case and are available in any of Inscape's standard paint finishes. They are nominal in height and support a worksurface at a standard 28.5" height.

## **LATERAL AND PEDESTAL RAIL KITS**

Lateral and Pedestal Rail Kits are available for separate purchase to create alternative applications when mounted on standard Office Specialty cases. These kits must be field installed. Rail Kits consist of a pair of extruded aluminum rails painted in 'Aluminum Leaf' and a pair of mounting rails that act as a 'reveal' and secure the Planna Storage rails into a box substructure to support the Planna Storage 0.5" thick lateral top.

End anchor units must be 36" W. Specify CREDENZA STORAGE-KIT36 separately. Center units will be positioned back-to-back and may be 30", 36" or 42" W.

If Center Units = 30" W,  
specify 2 x CREDENZA STORAGEKIT3615

If Center Units = 36" W,  
specify 2 x CREDENZA STORAGEKIT36

If Center Units = 42" W,  
specify 2 x CREDENZA STORAGEKIT3621

Using pre-configured or buildup cases with 36" I.D. (interior dimension) will provide finished height to top of worksurface of 43". Use adjustment in Planna Storage brackets to lower worksurface height to suit seating height.

## **LATERAL TOPS**

The Lateral Tops are available in ½" and ¾" thick options. The ½" thick option has been designed for Planna Storage applications in freestanding, benching or private office applications (may be specified on any lateral case). When being specified with the top fully spanning the Planna Storage benching frame or partially, there are a number of tops to accommodate the clean visual of having a continuous top over the panel. Depths are 1.75" or 3.5" deeper than standard tops to accommodate the various Planna Storage benching applications. The 21.5" deep Planna Storage lateral tops work in conjunction with the two Planna Storage units which access electrical through the back of the case. The 3.5" gap created behind the case provides space for cables to be plugged in and routed into the case. The same concept may be applied when specifying lateral tops for Private Office applications and requiring an additional 3.5" deep top. The ¾" top is ideal for and freestanding lateral applications. These are NOT to be specified on Planna Storage cases.

## CUSHION PROGRAM

The **Classic Cushion** is 1 ¼" thick CAL 117 compliant polyurethane foam with a 2.3 lb/ft. density. This upholstered cushion is balanced with a ¼" board and is attached to the pedestal top with heavy duty Velcro. The 5-pc construction, features double row top stitching on all seams, seen in fine upholstered pieces. The result provides crisp rectilinear styling.

The **Lite Cushion** is ¾" thick CAL 117 compliant polyurethane foam with a 2.3 lb/ft. density. This upholstered cushion is balanced with a ¼" board and is attached to the pedestal top with Velcro. Our Lite Cushion has seamless features allowing it to highlight the fabric details. The result provides a modern and simple look.

The Lite Cushion is available in the following Grade A fabrics only: Fedora, Glint, Pebble, Rancho & Script

Select from our graded upholstery program of solid color fabrics and vinyl's or choose COM option (Customers Own Material). To determine if a COM fabric has been pre-approved for use on our cushion topper, contact your Client Services Representative or go to [inscapesolutions.com](http://inscapesolutions.com).

For application of all fabrics, both from our graded program as well as COM (Customers Own Material) please specify lay-up orientation at time of order. If lay-up instructions are not provided we will choose the direction to maximize our production. Refer to diagram for lay-up instructions. Please contact your Client Services Representative to confirm yardage requirements for your order. All COM fabric must be pre-approved. Your CSR can determine if your COM has already been pretested for application. A fully graded program has been set up for cushions. Various sizes of cushion have been designed for applications ranging from freestanding, benching and private office applications.

## CUSHION APPLICATION NOTES

When ordering a Planna Storage cushion to lie flush next to a Planna Storage case with rail/lateral surface, select your Planna Storage case with 'no rails' option.

## PEDESTAL FABRIC LAY UP INSTRUCTIONS

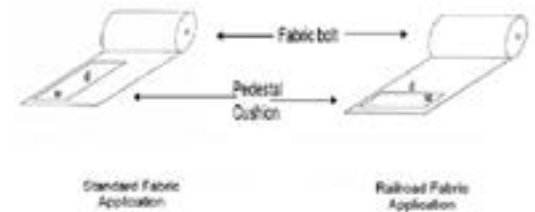



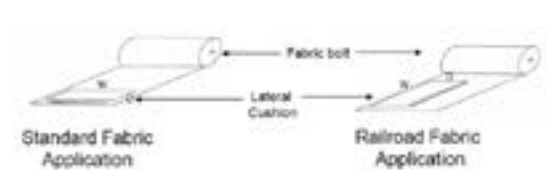

## LATERAL FABRIC LAY UP INSTRUCTIONS



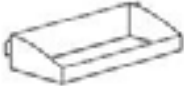

**Due to the nature of the design and manufacture of our cushion, only approved fabrics will be accepted for application. For a description of the procedure required for COM fabric approval see sample 'Cushion COM Test Request' form found in the General Information section of this price list. This form can be downloaded from the Administration section of Insite or by contacting your Client Services Representative for assistance.**

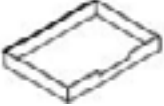
**Please see Finishes section for COM calculator.**

- Horizontal Paper Management accessories hang on panel mounted or wall hung paper management tile



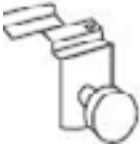

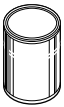
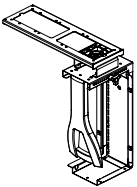
		Part number	H	W	Wt (lbs)	Neutral paint/ base price	Accent paint
	Storage Compartment Acrylic	<b>INSC4334</b>	1 ½"	3"	0.1	\$25	—
		<b>INSC4534</b>	1 ½"	5"	0.1	\$27	—
		<b>INSC4734</b>	1 ½"	7"	0.1	\$29	—
	Slanted Sorter	<b>INHLHSS</b> left-handed	11 ¾"	2 ¼"	4	\$76	+\$11
		<b>INHRHSS</b> right-handed (illustrated)	11 ¾"	2 ¼"	4	\$76	+\$11
	Storage Box	<b>INBTSB</b>	2"	12"	2	\$146	+\$18
	Closed Shelf	<b>INBTSHC</b>	2"	12"	2	\$167	+\$20
	Open Shelf	<b>INBTSHF</b>	2"	12"	2	\$111	+\$15

- “2F” denotes use with 2 ¾" thick frame  
“3F” denotes use with 3 ½" thick frame
- Pencil Drawer is available in black only
- Pencil Drawer installed depth is 15 ¼" and the extended depth is 26"
- CPU holder mounts to the underside of a worksurface (See Inscape System Application Guide)
- The AU200CU is non-locking and has a track size of 17". It has a weight capacity of 13lbs and a plastic glide track style.
- The AU300CU is non-locking and has a track size of 17". It has a weight capacity of 17lbs and a ball bearing style track.
- Both CPU holders have a height range of 14.5"/22.5" and a width range of 3.5"/9.3"



	Part number	H	W	Wt (lbs)	Neutral paint/ base price	Accent paint
	Signage (Qty of 6) <b>INPS2259-1</b>	2 ¼"	9"	1	\$105	+\$13
	Coat Hook <b>INCOATHOOK-3F</b> <b>INCOATHOOK-2F</b>	— —	— —	1 1	\$31 \$31	+\$7 +\$7
	Picture Hook <b>INPICHOOK-3F</b> <b>INPICHOOK-2F</b>	— —	— —	1 1	\$27 \$27	+\$7 +\$7
	Pencil Drawer Undersurface mounted <b>INFPD15</b>	—	15"	3	\$84	—
	Touch-up paint for standard enamel finishes Specify finish. Can contains a half pint <b>PAINT</b>	—	—	0.5	\$45	—
	CPU Holder <b>INAU200CU</b> <b>INAU300CU</b>	14.5"-22.5" 14.5"-22.5"	3.5"-9.3" 3.5"-9.3"	13 13	\$383 \$466	
	System Care Kit For use with 3 ½" T frames <b>INCAREKT-3F</b> <b>INCAREKT-2F</b>	— —	— —	— —	— —	\$139 \$115

**NOTES**

- Only Expo Markers are to be used on any Inscape Whiteboard. Whiteboards should be cleaned with Expo Eraser or a Microfiber cleaning cloth along with Expo Cleaning Solution which is formulated to remove residue from Expo Dry Erase Markers

		Part number	H	W	Wt (lbs)	List price
	13.5" H Panel Mounted Whiteboard For use with 3 ½" T frames	<b>INWHBD24135-3F</b>	13.5"	24"	10	\$276
		<b>INWHBD30135-3F</b>	13.5"	30"	13	\$285
		<b>INWHBD36135-3F</b>	13.5"	36"	14	\$292
		<b>INWHBD42135-3F</b>	13.5"	42"	16	\$304
		<b>INWHBD48135-3F</b>	13.5"	48"	18	\$312
	27" H Panel Mounted Whiteboard For use with 3 ½" T frames	<b>INWHBD2427-3F</b>	27"	24"	11	\$366
		<b>INWHBD3027-3F</b>	27"	30"	13	\$375
		<b>INWHBD3627-3F</b>	27"	36"	14	\$383
		<b>INWHBD4227-3F</b>	27"	42"	16	\$391
		<b>INWHBD4827-3F</b>	27"	48"	18	\$401
	13.5" H Panel Mounted Whiteboard For use with 2 ¾" T frames	<b>INWHBD24135-2F</b>	13.5"	24"	10	\$276
		<b>INWHBD30135-2F</b>	13.5"	30"	13	\$285
		<b>INWHBD36135-2F</b>	13.5"	36"	14	\$292
		<b>INWHBD42135-2F</b>	13.5"	42"	16	\$304
		<b>INWHBD48135-2F</b>	13.5"	48"	18	\$312
	27" H Panel Mounted Whiteboard For use with 2 ¾" T frames	<b>INWHBD2427-2F</b>	27"	24"	11	\$366
		<b>INWHBD3027-2F</b>	27"	30"	13	\$375
		<b>INWHBD3627-2F</b>	27"	36"	14	\$383
		<b>INWHBD4227-2F</b>	27"	42"	16	\$391
		<b>INWHBD4827-2F</b>	27"	48"	18	\$401

- “2F” denotes use with 2 ¾" thick frame
- “3F” denotes use with 3 ½" thick frame
- Crossrails may be installed on a frame of the same thickness in pre-drilled locations in frame

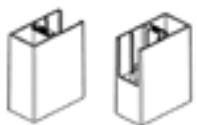
		Part number	H	W	Wt (lbs)	List price
	Crossrail For use with 3 ½" T frames Includes tile clips	<b>INCRAIL18-3F</b>	—	18"	1	\$29
		<b>INCRAIL24-3F</b>	—	24"	1	\$31
		<b>INCRAIL30-3F</b>	—	30"	1	\$34
		<b>INCRAIL36-3F</b>	—	36"	1	\$36
		<b>INCRAIL42-3F</b>	—	42"	2	\$39
		<b>INCRAIL48-3F</b>	—	48"	2	\$43
		<b>INCRAIL54-3F</b>	—	54"	2	\$47
		<b>INCRAIL60-3F</b>	—	60"	2	\$49
	Crossrail For use with 2 ¾" T frames Includes tile clips	<b>INCRAIL18-2F</b>	—	18"	1	\$29
		<b>INCRAIL24-2F</b>	—	24"	1	\$31
		<b>INCRAIL30-2F</b>	—	30"	1	\$34
		<b>INCRAIL36-2F</b>	—	36"	1	\$36
		<b>INCRAIL42-2F</b>	—	42"	2	\$39
		<b>INCRAIL48-2F</b>	—	48"	2	\$43
		<b>INCRAIL54-2F</b>	—	54"	2	\$47
		<b>INCRAIL60-2F</b>	—	60"	2	\$49
	Rectangular Glide (Pair) Gray finish	<b>INFRMREC-GLIDE</b>	—	—	—	\$51

- Modesty panels are available in a variety of materials and mounting options correspond with each variety
- Modesty panels mount to the underside of worksurface and are field installed
- See Application Guide for specific dimension detailed applications
- All hardware included
- Modesty panel use with a Height Adjustable Table, specify modesty panel 12" shorter in length than the surface
- Nuform finish is on one side with white backer

**NOTES**

In order to get a total cost on products when upcharges are present take the list price of the product number and add the upcharge cost shown to the list price.

For example:

Product INMDPNP30 in Grande 1 laminate would be \$312 +\$101

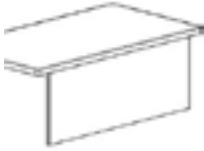

	Part number	H	W	Wt (lbs)	Neutral paint/ base price	Accent paint
Painted Partial Height Modesty Panel	<b>INMDPNP30</b>	13 ½"	30"	5	\$135	+\$17
	<b>INMDPNP33</b>	13 ½"	33"	5.5	\$139	+\$17
	<b>INMDPNP36</b>	13 ½"	36"	6	\$141	+\$17
	<b>INMDPNP39</b>	13 ½"	39"	6.5	\$144	+\$18
	<b>INMDPNP42</b>	13 ½"	42"	7	\$147	+\$18
	<b>INMDPNP45</b>	13 ½"	45"	7.5	\$152	+\$18
	<b>INMDPNP48</b>	13 ½"	48"	8	\$159	+\$19
	<b>INMDPNP51</b>	13 ½"	51"	8.5	\$161	+\$19
	<b>INMDPNP54</b>	13 ½"	54"	9	\$164	+\$19
	<b>INMDPNP57</b>	13 ½"	57"	9.5	\$167	+\$20
	<b>INMDPNP60</b>	13 ½"	60"	10	\$169	+\$20
	<b>INMDPNP63</b>	13 ½"	63"	10.5	\$171	+\$20
	<b>INMDPNP66</b>	13 ½"	66"	11	\$173	+\$20
	<b>INMDPNP69</b>	13 ½"	69"	11.5	\$174	+\$20
<b>INMDPNP72</b>	13 ½"	72"	12	\$178	+\$21	



	Part number	H	W	Wt (lbs)	Nuform classic/ laminate/base price	Nuform select	Grade 1 laminate	Accent paint
Wood Core Partial Height Modesty Panel	<b>INMDPNW30</b>	13 ½"	30"	12	\$312	+\$35	+\$101	+\$33
	<b>INMDPNW33</b>	13 ½"	33"	13	\$333	+\$37	+\$107	+\$35
	<b>INMDPNW36</b>	13 ½"	36"	14	\$342	+\$39	+\$111	+\$36
	<b>INMDPNW39</b>	13 ½"	39"	15	\$382	+\$44	+\$125	+\$42
	<b>INMDPNW42</b>	13 ½"	42"	16	\$389	+\$45	+\$127	+\$43
	<b>INMDPNW45</b>	13 ½"	45"	17.5	\$399	+\$46	+\$130	+\$44
	<b>INMDPNW48</b>	13 ½"	48"	19	\$405	+\$47	+\$131	+\$44
	<b>INMDPNW51</b>	13 ½"	51"	20	\$444	+\$50	+\$143	+\$48
	<b>INMDPNW54</b>	13 ½"	54"	21	\$452	+\$51	+\$145	+\$48
	<b>INMDPNW57</b>	13 ½"	57"	22	\$463	+\$52	+\$148	+\$49
	<b>INMDPNW60</b>	13 ½"	60"	23.5	\$485	+\$54	+\$158	+\$51
	<b>INMDPNW63</b>	13 ½"	63"	24.5	\$566	+\$63	+\$182	+\$59
	<b>INMDPNW66</b>	13 ½"	66"	26	\$590	+\$66	+\$191	+\$61
	<b>INMDPNW69</b>	13 ½"	69"	27	\$612	+\$69	+\$198	+\$63
	<b>INMDPNW72</b>	13 ½"	72"	28	\$637	+\$71	+\$206	+\$65
	<b>INMDPNW75</b>	13 ½"	75"	29	\$709	+\$79	+\$228	+\$72
	<b>INMDPNW78</b>	13 ½"	78"	30.5	\$714	+\$80	+\$231	+\$73
	<b>INMDPNW81</b>	13 ½"	81"	31.5	\$722	+\$81	+\$234	+\$73
	<b>INMDPNW84</b>	13 ½"	84"	33	\$726	+\$81	+\$235	+\$74
	<b>INMDPNW87</b>	13 ½"	87"	34	\$733	+\$83	+\$237	+\$74
<b>INMDPNW90</b>	13 ½"	90"	35	\$737	+\$83	+\$238	+\$76	

- Modesty panels are available in a variety of materials and mounting options correspond with each variety
- Modesty panels mount to the underside of worksurface and are field installed
- See Application Guide for specific dimension detailed applications
- All hardware included
- Modesty panel use with a Height Adjustable Table, specify modesty panel 12" shorter in length than the surface
- Acrylic Partial Height Modesty Panel comes in white acrylic only

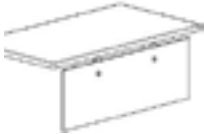

	Part number	H	W	Wt (lbs)	Neutral paint/ base price	Accent paint
Acrylic Partial Height Modesty Panel	<b>INMDPNA30</b>	13 1/2"	30"	4	\$510	+\$53
	<b>INMDPNA33</b>	13 1/2"	33"	4.5	\$515	+\$54
	<b>INMDPNA36</b>	13 1/2"	36"	5	\$523	+\$54
	<b>INMDPNA39</b>	13 1/2"	39"	5.5	\$529	+\$56
	<b>INMDPNA42</b>	13 1/2"	42"	6	\$535	+\$56
	<b>INMDPNA45</b>	13 1/2"	45"	6	\$547	+\$57
	<b>INMDPNA48</b>	13 1/2"	48"	6.5	\$552	+\$58
	<b>INMDPNA51</b>	13 1/2"	51"	7	\$576	+\$60
	<b>INMDPNA54</b>	13 1/2"	54"	7.5	\$602	+\$62
	<b>INMDPNA57</b>	13 1/2"	57"	8	\$625	+\$64
	<b>INMDPNA60</b>	13 1/2"	60"	8	\$657	+\$67
	<b>INMDPNA63</b>	13 1/2"	63"	8.5	\$686	+\$70
	<b>INMDPNA66</b>	13 1/2"	66"	9	\$720	+\$73
	<b>INMDPNA69</b>	13 1/2"	69"	9.5	\$749	+\$77
	<b>INMDPNA72</b>	13 1/2"	72"	10	\$782	+\$81
	<b>INMDPNA75</b>	13 1/2"	75"	10	\$796	+\$84
	<b>INMDPNA78</b>	13 1/2"	78"	10.5	\$815	+\$85
	<b>INMDPNA81</b>	13 1/2"	81"	11	\$831	+\$87
	<b>INMDPNA84</b>	13 1/2"	84"	11.5	\$849	+\$88
	<b>INMDPNA87</b>	13 1/2"	87"	12	\$867	+\$90
<b>INMDPNA90</b>	13 1/2"	90"	12	\$885	+\$91	



- Modesty panels are available in a variety of materials and mounting options correspond with each variety
- Modesty panels mount to the underside of worksurface and are field installed
- See Application Guide for specific dimension detailed applications
- All hardware included
- Modesty panel use with a Height Adjustable Table, specify modesty panel 12" shorter in length than the surface
- Nuform finish is on one side with white backer

**NOTES**

In order to get a total cost on products when upcharges are present take the list price of the product number and add the upcharge cost shown to the list price.

For example:

Product INMDFHPNW30 in Grade 1 laminate would be \$401 +\$130



Wood Core Full Height Modesty Panel

Part number	H	W	Wt (lbs)	Nuform classic/ laminate/base price	Nuform select	Grade 1 laminate	Accent paint
<b>INMDFHPNW30</b>	24"	30"	21.5	\$401	+\$46	+\$130	+\$44
<b>INMDFHPNW33</b>	24"	33"	23.6	\$437	+\$50	+\$141	+\$47
<b>INMDFHPNW36</b>	24"	36"	25.8	\$445	+\$50	+\$144	+\$48
<b>INMDFHPNW39</b>	24"	39"	27.9	\$509	+\$58	+\$165	+\$53
<b>INMDFHPNW42</b>	24"	42"	30.1	\$519	+\$59	+\$168	+\$54
<b>INMDFHPNW45</b>	24"	45"	32.3	\$465	+\$52	+\$151	+\$49
<b>INMDFHPNW48</b>	24"	48"	34.4	\$540	+\$61	+\$174	+\$57
<b>INMDFHPNW51</b>	24"	51"	36.6	\$668	+\$74	+\$215	+\$69
<b>INMDFHPNW54</b>	24"	54"	38.7	\$680	+\$77	+\$219	+\$70
<b>INMDFHPNW57</b>	24"	57"	40.9	\$688	+\$77	+\$221	+\$71
<b>INMDFHPNW60</b>	24"	60"	47	\$708	+\$79	+\$228	+\$72
<b>INMDFHPNW63</b>	24"	63"	45.2	\$737	+\$83	+\$238	+\$76
<b>INMDFHPNW66</b>	24"	66"	47.3	\$756	+\$85	+\$243	+\$77
<b>INMDFHPNW69</b>	24"	69"	49.5	\$778	+\$87	+\$250	+\$81
<b>INMDFHPNW72</b>	24"	72"	51.7	\$793	+\$89	+\$255	+\$83
<b>INMDFHPNW75</b>	24"	75"	52.8	\$906	+\$101	+\$291	+\$93
<b>INMDFHPNW78</b>	24"	78"	56	\$912	+\$102	+\$293	+\$94
<b>INMDFHPNW81</b>	24"	81"	58.1	\$917	+\$102	+\$294	+\$94
<b>INMDFHPNW84</b>	24"	84"	60.3	\$924	+\$103	+\$296	+\$96
<b>INMDFHPNW87</b>	24"	87"	62.4	\$929	+\$103	+\$299	+\$96
<b>INMDFHPNW90</b>	24"	90"	64.6	\$939	+\$104	+\$302	+\$97

- Table mounted screens mount to worksurfaces
- Adjustable Framed Table Mounted Screens have height adjustment for above worksurface privacy and below the worksurface modesty. It is recommended that this screen be installed with a max of 20" above the surface.
- Table Mounted Acrylic Screens have approx. 16" of screen above the surface and approx. 3" below the surface
- Freestanding Table Screen is made of 6mm thick frosted acrylic which is 13" H, seated in a painted aluminum extrusion, which can be painted any of Inscape's standard colors. This screen is 5" less in depth than depth of worksurface it will be placed on
- Hardware is included

**NOTES**

In order to get a total cost on products when upcharges are present take the list price of the product number and add the upcharge cost shown to the list price.

For example:

Product MST3736 in Grade 5 Fabric would be \$607 +\$156

Product SWTMS48 in White Acrylic would be \$867 +\$103

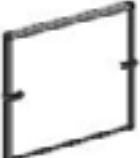
	Part number	H	W	Wt (lbs)	Grade 1/ COM/ base price	Grade 2	Grade 3	Grade 4	Grade 5	Grade 6	Grade 7	Grade 8	Accent paint
	<b>MST3736</b>	37"	36"	13	\$607	+\$58	+\$90	—	+\$156	+\$289	+\$426	—	+\$63
	<b>MST3742</b>	37"	42"	15	\$633	+\$59	+\$91	—	+\$156	+\$293	+\$430	—	+\$65
	<b>MST3748</b>	37"	48"	16	\$658	+\$64	+\$92	—	+\$157	+\$296	+\$435	—	+\$67
	<b>MST3754</b>	37"	54"	18	\$681	+\$66	+\$98	—	+\$160	+\$305	+\$444	—	+\$70
	<b>MST3760</b>	37"	60"	19	\$705	+\$72	+\$103	—	+\$160	+\$312	+\$455	—	+\$72

37" H Adjustable Framed  
Table Mounted Screen  
Tackable

	Part number	H	W	Wt (lbs)	Clear acrylic/ base price	White acrylic	Frosted acrylic
	<b>SWTMS48</b>	20"	48"	4	\$867	+\$103	+\$103
	<b>SWTMS54</b>	20"	54"	5	\$1359	+\$214	+\$214
	<b>SWTMS60</b>	20"	60"	6	\$1575	+\$213	+\$213

Table Mounted Acrylic  
Screen

	Part number	H	W	Wt (lbs)	Neutral paint/ base price	Accent paint
	<b>INSPS24</b>	13"	19"	2	\$121	+\$16
	<b>INSPS30</b>	13"	25"	2.5	\$169	+\$20
	<b>INSPS32</b>	13"	28"	3	\$177	+\$20
	<b>INSPS36</b>	13"	31"	3.5	\$183	+\$21

Freestanding Table Screen

- Table mounted screens mount to worksurfaces
- Table Mounted Screen/Modesty has 14" of the tackboard mounted above the surface and 13 ½" below
- Flat and Curved Table Mounted Metal Screens include an optional tackboard which, when selected, ships separately
- Flat Table Mounted Metal Screens are for use with any surface
- Curved Table Mounted Metal Screens are for use with INLAK Freestanding and Mobile Tables only
- Curved Table Mounted Metal Screens are for use on worksurfaces with a width of 48" or 60" depending on screen chosen
- Flat and Curved Table Mounted Metal Screens have 14 ¼" of the screens mounted above the surface and 6" below
- Hardware is included

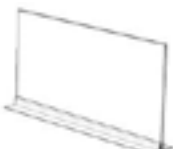
**NOTES**

In order to get a total cost on products when upcharges are present take the list price of the product number and add the upcharge cost shown to the list price.

For example:

Product INTMSF2948 in Grade B Fabric would be \$1281 +\$182

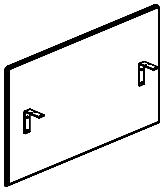
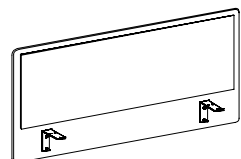

Table Mounted Screen/  
Modesty  
Tackable

Part number	H	W	Wt (lbs)	Grade A/ base price	Grade B/ COM	Grade C	Grade D	Grade E	Grade F	Accent paint
<b>INTMSF2948</b>	29"	48"	—	\$1281	+\$182	+\$499	+\$967	+\$1165	+\$1590	+\$130
<b>INTMSF2954</b>	29"	54"	—	\$1300	+\$354	+\$691	+\$1170	+\$1394	+\$1956	+\$132
<b>INTMSF2960</b>	29"	60"	—	\$1387	+\$405	+\$781	+\$1306	+\$1555	+\$2175	+\$141



Flat Table Mounted Metal  
Screen

Part number	H	W	Screen list/base price	Tackboard Fabric options							Accent paint	
				No fabric tackboard	Grade 1/ COM	Grade 2	Grade 3	Grade 4	Grade 5	Grade 6		Grade 7
<b>INWMMFS2146</b>	21 ¼"	46"	\$785	-\$262	+\$0	+\$80	+\$125	—	—	—	+\$589	+\$86
<b>INWMMFS2158</b>	21 ¼"	58"	\$896	-\$273	+\$0	+\$90	+\$141	—	—	—	+\$589	+\$97

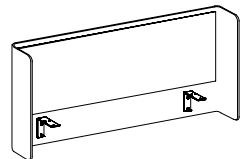

Curved Table Mounted  
Metal Screen

<b>INWMMCS2148</b>	21 ¼"	48"	\$862	-\$262	+\$0	+\$88	+\$135	—	—	—	+\$644	+\$93
<b>INWMMCS2160</b>	21 ¼"	60"	\$1038	-\$273	+\$0	+\$103	+\$162	—	—	—	+\$767	+\$111

## Accessories

Add-on Glazing  
3 1/2" T

# System

- “2F” denotes use with 2 3/4" thick frame  
“3F” denotes use with 3 1/2" thick frame
- Add-on Glazing comes complete with mounting hardware and top cap
- Add-on Glazing may span multiple frames according to guidelines set in the “Inscape System Application Guide”
- One glaze Alignment clip is included with each Add-on Glazing
- Add-on Glazing up to 60" W require two additional Jesters to be specified if spanning multiple frames (ie a 60" W AOG installed on 2-30" frames)
- **Tapered is not available in 66" or wider**
- **List/Base for 0.25" thick is clear glass**
- **0.38" thick is NOT available in tapered**

### NOTES

In order to get a total cost on products when upcharges are present take the list price of the product number and add the upcharge cost shown to the list price.

For example:

Product INAG6.7518-3F 0.25" thick glass with Gray would be \$160 +\$92

The same product upgraded to 0.38" thick glass would be \$160 +\$79 +\$212

Part number	W	List/base / 0.25" thick glazing price	Glazing thickness option	0.25" thick finish options				0.38" thick finish options			Accent paint	
			0.38" thick glazing	Clear	Gray	Etched 1 side	Etched 2 side	Clear	Gray	Etched 1 side		
 6.75" H Add-On Glazing For use with 3 1/2" T frames	<b>INAG6.7518-3F</b>	18"	\$160	+\$79	+\$0	+\$92	+\$92	+\$168	+\$0	+\$212	+\$212	+\$19
	<b>INAG6.7524-3F</b>	24"	\$198	+\$98	+\$0	+\$89	+\$89	+\$169	+\$0	+\$225	+\$225	+\$22
	<b>INAG6.7530-3F</b>	30"	\$225	+\$112	+\$0	+\$108	+\$108	+\$213	+\$0	+\$273	+\$273	+\$25
	<b>INAG6.7536-3F</b>	36"	\$248	+\$124	+\$0	+\$119	+\$119	+\$260	+\$0	+\$295	+\$295	+\$27
	<b>INAG6.7542-3F</b>	42"	\$265	+\$132	+\$0	+\$124	+\$124	+\$270	+\$0	+\$312	+\$312	+\$29
	<b>INAG6.7548-3F</b>	48"	\$286	+\$140	+\$0	+\$128	+\$128	+\$276	+\$0	+\$329	+\$329	+\$31
	<b>INAG6.7554-3F</b>	54"	\$305	+\$152	+\$0	+\$131	+\$131	+\$280	+\$0	+\$343	+\$343	+\$33
	<b>INAG6.7560-3F</b>	60"	\$329	+\$164	+\$0	+\$144	+\$144	+\$310	+\$0	+\$376	+\$376	+\$35
	<b>INAG6.7566-3F</b>	66"	\$341	+\$168	+\$0	+\$179	+\$179	+\$336	+\$0	+\$434	+\$434	+\$36
	<b>INAG6.7572-3F</b>	72"	\$358	+\$178	+\$0	+\$199	+\$199	+\$368	+\$0	+\$471	+\$471	+\$37
	<b>INAG6.7578-3F</b>	78"	\$456	+\$223	+\$0	+\$154	+\$154	+\$316	+\$0	+\$453	+\$453	+\$49
	<b>INAG6.7584-3F</b>	84"	\$533	+\$263	+\$0	+\$129	+\$129	+\$282	+\$0	+\$453	+\$453	+\$56
	<b>INAG6.7590-3F</b>	90"	\$611	+\$302	+\$0	+\$102	+\$102	+\$250	+\$0	+\$453	+\$453	+\$63
<b>INAG6.7596-3F</b>	96"	\$688	+\$340	+\$0	+\$77	+\$77	+\$218	+\$0	+\$453	+\$453	+\$71	

# Accessories

Add-on Glazing  
3 1/2" T

# System

- “2F” denotes use with 2 3/4" thick frame  
“3F” denotes use with 3 1/2" thick frame
- Add-on Glazing comes complete with mounting hardware and top cap
- Add-on Glazing may span multiple frames according to guidelines set in the “Inscope System Application Guide”
- One glaze Alignment clip is included with each Add-on Glazing
- Add-on Glazing up to 60" W require two additional Jesters to be specified if spanning multiple frames (ie a 60" W AOG installed on 2-30" frames)
- **Tapered is not available in 66" or wider**
- **List/Base for 0.25" thick is clear glass**
- **0.38" thick is NOT available in tapered**

### NOTES

In order to get a total cost on products when upcharges are present take the list price of the product number and add the upcharge cost shown to the list price.



For example:

Product INAG13.518-3F 0.25" thick glass with Gray would be \$169 +\$88

The same product upgraded to 0.38" thick glass would be \$169 +\$86 +\$210

Part number	W	List/base / 0.25" thick glazing price	Glazing thickness option	0.25" thick finish options				0.38" thick finish options			Accent paint	
			0.38" thick glazing	Clear	Gray	Etched 1 side	Etched 2 side	Clear	Gray	Etched 1 side		
	<b>INAG13.518-3F</b>	18"	\$169	+\$86	+\$0	+\$88	+\$88	+\$161	+\$0	+\$210	+\$210	+\$20
	<b>INAG13.524-3F</b>	24"	\$200	+\$99	+\$0	+\$90	+\$90	+\$171	+\$0	+\$227	+\$227	+\$22
	<b>INAG13.530-3F</b>	30"	\$227	+\$114	+\$0	+\$112	+\$112	+\$214	+\$0	+\$277	+\$277	+\$25
	<b>INAG13.536-3F</b>	36"	\$256	+\$128	+\$0	+\$133	+\$133	+\$258	+\$0	+\$324	+\$324	+\$27
	<b>INAG13.542-3F</b>	42"	\$287	+\$142	+\$0	+\$156	+\$156	+\$301	+\$0	+\$371	+\$371	+\$31
	<b>INAG13.548-3F</b>	48"	\$317	+\$157	+\$0	+\$178	+\$178	+\$343	+\$0	+\$421	+\$421	+\$33
	<b>INAG13.554-3F</b>	54"	\$347	+\$171	+\$0	+\$199	+\$199	+\$383	+\$0	+\$465	+\$465	+\$36
	<b>INAG13.560-3F</b>	60"	\$376	+\$185	+\$0	+\$220	+\$220	+\$427	+\$0	+\$513	+\$513	+\$42
	<b>INAG13.566-3F</b>	66"	\$404	+\$200	+\$0	+\$245	+\$245	+\$459	+\$0	+\$561	+\$561	+\$44
	<b>INAG13.572-3F</b>	72"	\$470	+\$229	+\$0	+\$220	+\$220	+\$435	+\$0	+\$560	+\$560	+\$50
	<b>INAG13.578-3F</b>	78"	\$535	+\$264	+\$0	+\$208	+\$208	+\$413	+\$0	+\$571	+\$571	+\$56
	<b>INAG13.584-3F</b>	84"	\$604	+\$296	+\$0	+\$196	+\$196	+\$393	+\$0	+\$586	+\$586	+\$62
	<b>INAG13.590-3F</b>	90"	\$671	+\$331	+\$0	+\$173	+\$173	+\$371	+\$0	+\$586	+\$586	+\$69
	<b>INAG13.596-3F</b>	96"	\$739	+\$366	+\$0	+\$160	+\$160	+\$348	+\$0	+\$599	+\$599	+\$76

13.5" H Add-On Glazing  
For use with 3 1/2" T frames

	Part number	List price
	<b>QCCLIPASSY-3F</b>	\$9
	<b>QCCLIPASSY-3FT</b>	\$8

# Accessories

Add-on Glazing  
2 3/4" T

# System

- “2F” denotes use with 2 3/4" thick frame  
“3F” denotes use with 3 1/2" thick frame
- Add-on Glazing comes complete with mounting hardware and top cap
- Add-on Glazing may span multiple frames according to guidelines set in the “Inscape System Application Guide”
- One glaze Alignment clip is included with each Add-on Glazing
- Add-on Glazing up to 60" W require two additional Jesters to be specified if spanning multiple frames (ie a 60" W AOG installed on 2-30" frames)
- **Tapered is not available in 2 3/4" T**
- **List/Base for 0.25" thick is clear glass**
- **0.38" thick is NOT available in tapered**



## NOTES

In order to get a total cost on products when upcharges are present take the list price of the product number and add the upcharge cost shown to the list price.

For example:

Product INAG6.7518-2F 0.25" thick glass with Gray would be \$160 +\$92

The same product upgraded to 0.38" thick glass would be \$160 +\$79 +\$212

Part number	W	List/base / 0.25" thick glazing price	Glazing thickness option	0.25" thick finish options				0.38" thick finish options			Accent paint	
			0.38" thick glazing	Clear	Gray	Etched 1 side	Etched 2 side	Clear	Gray	Etched 1 side		
 6.75" H Add-On Glazing For use with 2 3/4" T frames	INAG6.7518-2F	18"	\$160	+\$79	+\$0	+\$92	+\$92	+\$168	+\$0	+\$212	+\$212	+\$19
	INAG6.7524-2F	24"	\$198	+\$98	+\$0	+\$89	+\$89	+\$169	+\$0	+\$225	+\$225	+\$22
	INAG6.7530-2F	30"	\$225	+\$112	+\$0	+\$108	+\$108	+\$213	+\$0	+\$273	+\$273	+\$25
	INAG6.7536-2F	36"	\$248	+\$124	+\$0	+\$119	+\$119	+\$260	+\$0	+\$295	+\$295	+\$27
	INAG6.7542-2F	42"	\$265	+\$132	+\$0	+\$124	+\$124	+\$270	+\$0	+\$312	+\$312	+\$29
	INAG6.7548-2F	48"	\$286	+\$140	+\$0	+\$128	+\$128	+\$276	+\$0	+\$329	+\$329	+\$31
	INAG6.7554-2F	54"	\$305	+\$152	+\$0	+\$131	+\$131	+\$280	+\$0	+\$343	+\$343	+\$33
	INAG6.7560-2F	60"	\$329	+\$164	+\$0	+\$144	+\$144	+\$310	+\$0	+\$376	+\$376	+\$35
	INAG6.7566-2F	66"	\$341	+\$168	+\$0	+\$179	+\$179	+\$336	+\$0	+\$434	+\$434	+\$36
	INAG6.7572-2F	72"	\$358	+\$178	+\$0	+\$199	+\$199	+\$368	+\$0	+\$471	+\$471	+\$37
	INAG6.7578-2F	78"	\$456	+\$223	+\$0	+\$154	+\$154	+\$316	+\$0	+\$453	+\$453	+\$49
	INAG6.7584-2F	84"	\$533	+\$263	+\$0	+\$129	+\$129	+\$282	+\$0	+\$453	+\$453	+\$56
	INAG6.7590-2F	90"	\$611	+\$302	+\$0	+\$102	+\$102	+\$250	+\$0	+\$453	+\$453	+\$63
INAG6.7596-2F	96"	\$688	+\$340	+\$0	+\$77	+\$77	+\$218	+\$0	+\$453	+\$453	+\$71	
 13.5" H Add-On Glazing For use with 2 3/4" T frames	INAG13.518-2F	18"	\$169	+\$86	+\$0	+\$88	+\$88	+\$161	+\$0	+\$210	+\$210	+\$20
	INAG13.524-2F	24"	\$200	+\$99	+\$0	+\$90	+\$90	+\$171	+\$0	+\$227	+\$227	+\$22
	INAG13.530-2F	30"	\$227	+\$114	+\$0	+\$112	+\$112	+\$214	+\$0	+\$277	+\$277	+\$25
	INAG13.536-2F	36"	\$256	+\$128	+\$0	+\$133	+\$133	+\$258	+\$0	+\$324	+\$324	+\$27
	INAG13.542-2F	42"	\$287	+\$142	+\$0	+\$156	+\$156	+\$301	+\$0	+\$371	+\$371	+\$31
	INAG13.548-2F	48"	\$317	+\$157	+\$0	+\$178	+\$178	+\$343	+\$0	+\$421	+\$421	+\$33
	INAG13.554-2F	54"	\$347	+\$171	+\$0	+\$199	+\$199	+\$383	+\$0	+\$465	+\$465	+\$36
	INAG13.560-2F	60"	\$376	+\$185	+\$0	+\$220	+\$220	+\$427	+\$0	+\$513	+\$513	+\$42
	INAG13.566-2F	66"	\$404	+\$200	+\$0	+\$245	+\$245	+\$459	+\$0	+\$561	+\$561	+\$44
	INAG13.572-2F	72"	\$470	+\$229	+\$0	+\$220	+\$220	+\$470	+\$0	+\$560	+\$560	+\$50
	INAG13.578-2F	78"	\$535	+\$264	+\$0	+\$208	+\$208	+\$413	+\$0	+\$571	+\$571	+\$56
	INAG13.584-2F	84"	\$604	+\$296	+\$0	+\$196	+\$196	+\$393	+\$0	+\$586	+\$586	+\$62
	INAG13.590-2F	90"	\$671	+\$331	+\$0	+\$173	+\$173	+\$371	+\$0	+\$586	+\$586	+\$69
INAG13.596-2F	96"	\$739	+\$366	+\$0	+\$160	+\$160	+\$348	+\$0	+\$599	+\$599	+\$76	

## Accessories

Add-on Glazing  
2 3/4" T





- "2F" denotes use with 2 3/4" thick frame
- "3F" denotes use with 3 1/2" thick frame
- Add-on Glazing comes complete with mounting hardware and top cap
- Add-on Glazing may span multiple frames according to guidelines set in the "Inscape System Application Guide"
- One glaze Alignment clip is included with each Add-on Glazing
- Add-on Glazing up to 60"w require two additional Jesters to be specified if spanning multiple frames (ie a 60"w AOG installed on 2-30" frames)
- **Tapered is not available in 2 3/4" T**
- **List/Base for 0.25" thick is clear glass**
- **0.38" thick is NOT available in tapered**

	Part number	List price
 <p data-bbox="399 793 639 869">Add-On Glazing Top Cap Clip for 2 3/4" T Flat Trim Applications</p>	<b>QCCLIPASSY-2F</b>	<b>\$9</b>

- Wall mounted accessories may be specified to mount to any drywall application
- Additional wall bracing should be taken into consideration when ordering any wall hung component which will carry additional weight
- Ensure wall is adequately constructed and/or braced to ensure a secure installation
- All wall mount brackets are included

**NOTES**

- Only Expo Markers are to be used on any Inscape Whiteboard. Whiteboards should be cleaned with Expo Eraser or a Microfiber cleaning cloth along with Expo Cleaning Solution which is formulated to remove residue from Expo Dry Erase Markers

		Part number	H	W	Wt (lbs)		List price
	13.5" H Wall Mount Whiteboard Tile	<b>IN13.5WB30W</b>	13.5"	30"	3		\$245
		<b>IN13.5WB36W</b>	13.5"	36"	4		\$250
		<b>IN13.5WB42W</b>	13.5"	42"	4		\$254
		<b>IN13.5WB48W</b>	13.5"	48"	5		\$258
		<b>IN13.5WB54W</b>	13.5"	54"	6		\$260
		<b>IN13.5WB60W</b>	13.5"	60"	6		\$265
	20.25" H Wall Mount Whiteboard Tile	<b>IN20.25WB30W</b>	20.25"	30"	5		\$254
		<b>IN20.25WB36W</b>	20.25"	36"	6		\$262
		<b>IN20.25WB42W</b>	20.25"	42"	7		\$267
		<b>IN20.25WB48W</b>	20.25"	48"	8		\$273
		<b>IN20.25WB54W</b>	20.25"	54"	9		\$276
		<b>IN20.25WB60W</b>	20.25"	60"	9		\$286
	23.6" H Wall Mount Whiteboard To be used above Planna cases	<b>IN23.6WMWB24</b>	23.6"	24"	4		\$262
		<b>IN23.6WMWB30</b>	23.6"	30"	5		\$272
		<b>IN23.6WMWB36</b>	23.6"	36"	6		\$280
		<b>IN23.6WMWB42</b>	23.6"	42"	7		\$287
		<b>IN23.6WMWB48</b>	23.6"	48"	8		\$290
	6.75" H Wall Mount Paper Management	<b>IN6.75PM30W</b>	6.75"	30"	5	\$214	+\$24
		<b>IN6.75PM36W</b>	6.75"	36"	6.5	\$231	+\$25
		<b>IN6.75PM42W</b>	6.75"	42"	8.5	\$254	+\$27
		<b>IN6.75PM48W</b>	6.75"	48"	9	\$273	+\$30
		<b>IN6.75PM54W</b>	6.75"	54"	11	\$291	+\$31
		<b>IN6.75PM60W</b>	6.75"	60"	12.5	\$310	+\$33
	20.25" H Wall Mount Paper Management	<b>IN20.25PM24W</b>	20.25"	24"	12	\$506	+\$53
		<b>IN20.25PM30W</b>	20.25"	30"	15	\$667	+\$69
		<b>IN20.25PM36W</b>	20.25"	36"	18	\$696	+\$71
		<b>IN20.25PM42W</b>	20.25"	42"	21	\$755	+\$77
		<b>IN20.25PM48W</b>	20.25"	48"	24	\$814	+\$85



- Wall mounted accessories may be specified to mount to any drywall application
- Additional wall bracing should be taken into consideration when ordering any wall hung component which will carry additional weight
- Ensure wall in adequately constructed and/or braced to ensure a secure installation
- All wall mount brackets are included

**NOTES**

- See finishes section for fabrics that require scrim



Part number	W	Wt (lbs)	Grade 1/ COM/ base price	Grade 2	Grade 3	Grade 4	Grade 5	Grade 6	Grade 7	Grade 8	Scrim
<b>IN13.5TB18W</b>	18"	2	\$253	+\$9	+\$15	+\$22	+\$29	+\$46	+\$61	+\$46	+\$24
<b>IN13.5TB24W</b>	24"	3	\$262	+\$7	+\$12	+\$20	+\$26	+\$45	+\$60	+\$45	+\$26
<b>IN13.5TB30W</b>	30"	3	\$286	+\$8	+\$12	+\$20	+\$26	+\$45	+\$61	+\$45	+\$27
<b>IN13.5TB36W</b>	36"	4	\$291	+\$12	+\$26	+\$35	+\$45	+\$67	+\$92	+\$67	+\$29
<b>IN13.5TB42W</b>	42"	4	\$301	+\$11	+\$27	+\$36	+\$47	+\$72	+\$98	+\$72	+\$31
<b>IN13.5TB48W</b>	48"	5	\$309	+\$15	+\$27	+\$36	+\$47	+\$72	+\$99	+\$72	+\$32

13.5" H Wall Mount Tackboard



<b>IN20.25TB18W</b>	18"	3	\$290	+\$7	+\$13	+\$23	+\$33	+\$54	+\$76	+\$105	+\$26
<b>IN20.25TB24W</b>	24"	4	\$314	+\$8	+\$20	+\$29	+\$37	+\$61	+\$86	+\$118	+\$29
<b>IN20.25TB30W</b>	30"	5	\$323	+\$7	+\$21	+\$30	+\$39	+\$63	+\$88	+\$120	+\$31
<b>IN20.25TB36W</b>	36"	6	\$330	+\$10	+\$22	+\$33	+\$45	+\$71	+\$99	+\$137	+\$33
<b>IN20.25TB42W</b>	42"	7	\$341	+\$9	+\$16	+\$30	+\$45	+\$72	+\$101	+\$140	+\$35
<b>IN20.25TB48W</b>	48"	8	\$348	+\$11	+\$29	+\$42	+\$52	+\$86	+\$115	+\$161	+\$37

20.25" H Wall Mount Tackboard





<b>IN23.6WMTK24</b>	24"	4	\$425	+\$8	+\$15	+\$26	+\$39	+\$67	+\$97	+\$134	+\$30
<b>IN23.6WMTK30</b>	30"	5	\$439	+\$7	+\$16	+\$29	+\$44	+\$73	+\$104	+\$144	+\$32
<b>IN23.6WMTK36</b>	36"	6	\$448	+\$11	+\$22	+\$35	+\$49	+\$86	+\$119	+\$166	+\$34
<b>IN23.6WMTK42</b>	42"	7	\$462	+\$9	+\$16	+\$30	+\$46	+\$84	+\$119	+\$166	+\$36
<b>IN23.6WMTK48</b>	48"	8	\$471	+\$12	+\$26	+\$42	+\$54	+\$94	+\$133	+\$185	+\$39

23.6" H Wall Mount Tackboard  
To be used above Planna cases

**NOTES**

- Only Expo Markers are to be used on any Inscape Whiteboard. Whiteboards should be cleaned with Expo Eraser or a Microfiber cleaning cloth along with Expo Cleaning Solution which is formulated to remove residue from Expo Dry Erase Markers

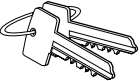
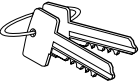
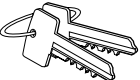
		Part number	H	W	Wt (lbs)	List price
	19.5" H Magnetic Whiteboard	<b>WHBDM137195</b>	19.5"	14"	3	\$291
	33" H Magnetic Whiteboard	<b>WHBDM13733</b>	33"	14"	5	\$310
	Replacement Key Specify key number found on face of lock	<b>RKEY</b>	—	—	—	\$12
	Master Key Specify key number found on face of lock	<b>MKEY</b>	—	—	—	\$51
	Extractor Key Specify key number found on face of lock	<b>EKEY</b>	—	—	—	\$51

- Overhead Storage sorters are to be ordered for use with overhead bin and shelves only
- No tools required to install components
- The sliding dividers are for use with Overhead Bin only

	Part number	H	W	Wt (lbs)	Neutral paint/ base price	Accent paint
 <p>Sliding Divider (qty of 3) Compatible with overhead bins</p>	<b>SDV</b>	—	—	5	\$103	+\$13

- The Electrified Twin-Bin accessories are able to mount onto the back of the Electrified Twin-Bin only
- Do not specify these accessories with the standard Twin-Bin as they will interfere with the sliding door
- Electrified Twin-Bin Tackboard available in all grades of fabric
- Electrified Twin-Bin Shelf is only compatible with the Electrified Twin-Bin
- The width of the Electrified Twin-Bin accessories specified should be  $\frac{1}{3}$  the overall width of the case (i.e.  $36 \div 3 = 12$ )

**NOTES**

- Only Expo Markers are to be used on any Inscape Whiteboard. Whiteboards should be cleaned with Expo Eraser or a Microfiber cleaning cloth along with Expo Cleaning Solution which is formulated to remove residue from Expo Dry Erase Markers

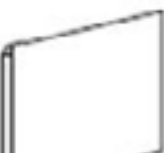
	Part number	H	W	Wt (lbs)	Neutral paint/ base price	Accent paint
	Electrified Twin-Bin Shelf					
	<b>INETWBSHF-12</b>	—	12"	—	\$105	+\$13
	<b>INETWBSHF-14</b>	—	14"	—	\$105	+\$13
	<b>INETWBSHF-16</b>	—	16"	—	\$105	+\$13
	<b>INETWBSHF-18</b>	—	18"	—	\$105	+\$13
	<b>INETWBSHF-20</b>	—	20"	—	\$105	+\$13
	Electrified Twin-Bin Whiteboard					
	<b>INTWBWB-12</b>	14"	12"	—	\$39	—
	<b>INTWBWB-14</b>	14"	14"	—	\$39	—
	<b>INTWBWB-16</b>	14"	16"	—	\$39	—
	<b>INTWBWB-18</b>	14"	18"	—	\$45	—
	<b>INTWBWB-20</b>	14"	20"	—	\$45	—

Part number	H	W	Wt (lbs)	Grade 1/ COM/ base price	Grade 2	Grade 3	Grade 4	Grade 5	Grade 6	Grade 7	Grade 8
<b>INTWBTB-12</b>	14"	12"	—	\$130	+\$8	+\$16	—	+\$29	—	+\$74	—
<b>INTWBTB-14</b>	14"	14"	—	\$133	+\$8	+\$16	—	+\$29	—	+\$74	—
<b>INTWBTB-16</b>	14"	16"	—	\$139	+\$8	+\$16	—	+\$29	—	+\$74	—
<b>INTWBTB-18</b>	14"	18"	—	\$145	+\$8	+\$16	—	+\$29	—	+\$74	—
<b>INTWBTB-20</b>	14"	20"	—	\$159	+\$8	+\$16	—	+\$29	—	+\$74	—



Electrified Twin-Bin Tackboard

- “2F” denotes use with 2 ¾" thick frame  
“3F” denotes use with 3 ½" thick frame
- Shared Twin Bin Top span the frame to give one complete finished top (no top trim required to be specified in this location)
- Single Twin Bin and Shared Twin Bin Tops are specified for the top of the Twin Bin
- Two Single Twin Bin Tops are required to finish one Twin Bin as there are two sides (either side of frame)
- Twin Bin tops are shipped complete with ability to mount directly on case
- Nuform Twin Bin Tops are ⅜" thick



**NOTES**

In order to get a total cost on products when upcharges are present take the list price of the product number and add the upcharge cost shown to the list price.



For example:







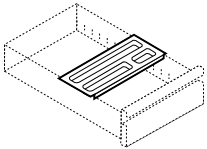
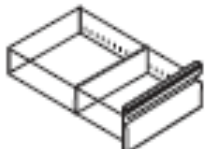
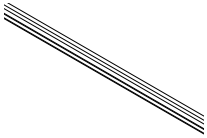
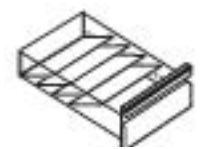
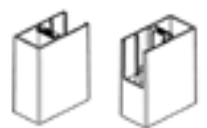

Product INTWBTOP36-3F 0.25" in Nuform Select would be \$279 +\$31

		Part number	H	W	Wt (lbs)	Neutral paint/ base price	Accent paint
	Shared Twin Bin Top, painted	<b>INTWST-30</b>	—	30"	—	\$320	+\$34
		<b>INTWST-36</b>	—	36"	—	\$388	+\$43
		<b>INTWST-42</b>	—	42"	—	\$403	+\$44
		<b>INTWST-48</b>	—	48"	—	\$442	+\$47
		<b>INTWST-54</b>	—	54"	—	\$481	+\$51
		<b>INTWST-60</b>	—	60"	—	\$518	+\$54

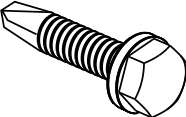

		Part number	D	W	Wt (lbs)	Nuform classic/ base price	Nuform select
	Single Twin Bin Top For use with 3 ½" T frames Required 2 per bin	<b>INTWBTOP36-3F</b>	5"	36"	2	\$279	+\$31
		<b>INTWBTOP42-3F</b>	5"	42"	2	\$289	+\$32
		<b>INTWBTOP48-3F</b>	5"	48"	2	\$318	+\$34
		<b>INTWBTOP60-3F</b>	5"	60"	3	\$371	+\$34
	Single Twin Bin Top For use with 2 ¾" T frames Required 2 per bin	<b>INTWBTOP36-2F</b>	5.4"	36"	2	\$279	+\$31
		<b>INTWBTOP42-2F</b>	5.4"	42"	2	\$289	+\$32
		<b>INTWBTOP48-2F</b>	5.4"	48"	2	\$318	+\$34
		<b>INTWBTOP60-2F</b>	5.4"	60"	3	\$371	+\$34

- Pedestal Extended leveling glide consists of a 1.5" stem

		Part number	H	W	Wt (lbs)	List price
	Pencil tray for letter width box drawer Black plastic	<b>PFWS-PT15</b>	—	15"	1	\$37
		Letter Width				
		<b>PFWS-PT18</b>	—	18"	1	\$37
		Legal Width				
	Divider for box drawer	<b>PFWS-DV15</b>	—	15"	0.5	\$22
		Letter Width				
		<b>PFWS-DV18</b>	—	18"	0.5	\$22
		Legal Width				
	Side-to-Side Filing Bar	<b>PFSSF15</b>	—	15"	—	\$8
		Letter Width				
		<b>PFSSF18</b>	—	18"	—	\$8
		Legal Width				
	Set of 4 modular sloped stationery dividers fits box drawer letter width pedestal	<b>PFMD-SO15</b>	—	15"	1	\$74
		Letter Width				
		<b>PFMD-SO18</b>	—	18"	1	\$79
		Legal Width				
	Rectangular Pedestal Glides, Gray Set of 4	<b>LV019</b>	—	—	—	\$46
	1.5" stem leveling glides Set of 4	<b>LG</b>	3 1/2"	—	1	\$29

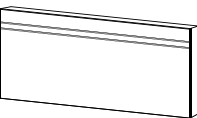
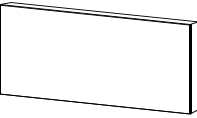
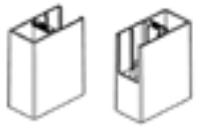

		Part number	H	W	Wt (lbs)	Neutral paint/ base price	Accent paint
	Plate divider for 3" and 4.5" shelves/drawers	<b>PFDVP-3</b>	—	—	0.5	\$21	—
	Plate divider for 6", 7.5" and 9" shelves/drawers	<b>PFDVP6-9</b>	—	—	0.75	\$21	—
	Plate divider for 10.5", 12", 13.5", 15" and 16.5" drawers or slotted shelves	<b>PFDVP</b>	—	—	1	\$21	—
	Slotted Shelf Fixed slotted shelf installs behind 12", 13.5", 15" and 16.5" lift-up door or in hinged door cabinet. Shelf is adjustable on a 1.5" increment.	<b>PFSH-30</b>	—	30"	11	\$101	+\$13
		<b>PFSH-36</b>	—	36"	12	\$101	+\$13
		<b>PFSH-42</b>	—	42"	13	\$101	+\$13
	Adjustable non-slotted shelf 15" deep	<b>BKSH-3015</b>	0.5"	30"	11	\$99	+\$13
		<b>BKSH-3615</b>	0.5"	36"	11	\$101	+\$13
		<b>BKSH-4215</b>	0.5"	42"	11	\$103	+\$13
	Standard Paper Related Accessories Hangfile bars for 10.5", 12", 13.5", 15" and 16.5" pullout shelves/drawers set of 2	<b>PFHF-30</b>	—	30"	2	\$45	—
		<b>PFHF-36</b>	—	36"	3	\$45	—
		<b>PFHF-42</b>	—	42"	4	\$45	—
	Sliding rails used in conjunction with HF bars for front-to-back filing, sold individually	<b>PFSR</b>	—	1.1875"	1	\$16	—
	Ganging Kit	<b>PFGK</b>	—	—	—	\$15	—
	18" mobile support frame, for 30" and 36" wide lateral files with maximum of three pullout drawers and maximum interior height of 43.5" Note: Counterweight must be installed in lateral file	<b>PFMFK18</b>	4 5/8"	—	10	\$540	—

- Counterweight recommended for all freestanding lateral file cabinets
- Counterweight secure with 2-way tape
- Lateral Extended leveling glide consists of a 1.5" stem



		Part number	H	W	Wt (lbs)	List price
	24" mobile support frame, for 24" and 30" wide Workplace Towers with maximum of three pullout drawers and maximum height of 58 3/4" Note: Counterweight is recommended	<b>PFMFK24</b>	4 5/8"	24"	11	\$540
	Counterweight, recommended for all freestanding lateral file cabinets with 22.5" interior dimension or higher	<b>IMCW-30</b>	—	30"	38	\$144
		<b>IMCW-36</b>	—	36"	38	\$144
		<b>IMCW-42</b>	—	42"	52	\$144
	Counterweight, recommended for all freestanding lateral file cabinets with less than 22.5" interior dimension	<b>CW</b>	—	—	48	\$144
	Rectangular Lateral Glides, Gray Set of 4	<b>LV018</b>	—	—	—	\$46
	1.5" stem leveling glides Set of 4	<b>LG</b>	3 1/2"	—	1	\$29



- Nuform lateral tops are 3/8" thick
- Lateral tops are not available with plywood edge band

	Part number	W	D	Nuform classic/ laminate/ base price	Nuform select	Grade 1 laminate	
	15" D x 3/8" T Lateral Top	<b>INSWTOP1530</b>	30"	15"	\$204	+\$17	+\$66
		<b>INSWTOP1536</b>	36"	15"	\$219	+\$32	+\$71
		<b>INSWTOP1542</b>	42"	15"	\$248	+\$35	+\$81
		<b>INSWTOP1548</b>	48"	15"	\$276	+\$43	+\$90
		<b>INSWTOP1554</b>	54"	15"	\$303	+\$48	+\$99
		<b>INSWTOP1560</b>	60"	15"	\$374	+\$106	+\$121
		<b>INSWTOP1572</b>	72"	15"	\$405	+\$127	+\$131
		<b>INSWTOP1578</b>	78"	15"	\$441	+\$115	+\$142
	18" D x 3/8" T Lateral Top	<b>INSWTOP1830</b>	30"	18"	\$221	+\$15	+\$72
		<b>INSWTOP1836</b>	36"	18"	\$238	+\$35	+\$77
		<b>INSWTOP1842</b>	42"	18"	\$267	+\$45	+\$88
		<b>INSWTOP1848</b>	48"	18"	\$295	+\$52	+\$97
		<b>INSWTOP1854</b>	54"	18"	\$328	+\$53	+\$106
		<b>INSWTOP1860</b>	60"	18"	\$507	+\$56	+\$165
		<b>INSWTOP1872</b>	72"	18"	\$605	+\$63	+\$196
		<b>INSWTOP1878</b>	78"	18"	\$704	+\$73	+\$227

- Includes stand offs to mount on back of case in the field
- Available in White only, colors as special

	Part number	H	W	Wt (lbs)	List price	
	Lateral Back Painted Glass	<b>PLN30LBPG</b>	24"	30"	16	\$799
		<b>PLN36LBPG</b>	24"	36"	19	\$885
		<b>PLN42LBPG</b>	24"	42"	22	\$972
	Pedestal Back Painted Glass	<b>PLN15LBPG</b>	24"	15"	16	\$628

- 30" W SuperStor™ insert accepts 12 Standard Trays and 3 Small Trays
- 36" W SuperStor™ insert accepts 18 Standard Trays
- 42" W SuperStor™ insert accepts 18 Standard Trays and 3 Small Trays
- Insert and trays may be painted in Inscape System standard color options

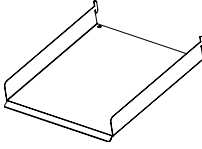
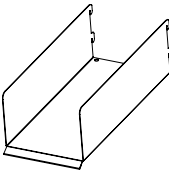
		Part number	H	W	Wt (lbs)	Neutral paint/ base paint	Accent paint
	SuperStor Inserts	<b>INSW13.5SS-30</b>	13.5"	30"	10	\$107	+\$15
		<b>INSW13.5SS-36</b>	13.5"	36"	12	\$127	+\$16
		<b>INSW13.5SS-42</b>	13.5"	42"	14	\$142	+\$18
	Standard SuperStor Trays (pkg. of 6)	<b>SWSSTRAY</b>	—	—	6	\$245	+\$26
	Small SuperStor Trays (pkg. of 3)	<b>SWSSTRAY-SM</b>	—	—	3	\$127	+\$16

- The Classic Cushion is 1 ¼" thick CAL 117 compliant polyurethane foam with a 2.3 lb/ft. density. This upholstered cushion is balanced with a 7/16" board and is attached to the pedestal top with heavy duty Velcro.
- The Lite Cushion is ¾" thick CAL 117 compliant polyurethane foam with a 2.3 lb/ft. density. This upholstered cushion is balanced with a ¼" board and is attached to the pedestal top with Velcro.
- Cushions may be installed on any storage case
- If optioning a cushion on a Planna case, remove Planna rail
- For application of ALL fabrics, both from our graded program as well as COM (customers own material), please specify layup orientation at time of order. If layup instructions are not provided we will choose the direction to maximize our production.

- Refer to the Finishes Section for additional layout and COM details

**NOTES**

In order to get a total cost on products when upcharges are present take the list price of the product number and add the upcharge cost shown to the list price.

For example:

Product CSH15X18X125 in Grade C fabric would be \$275 +\$103

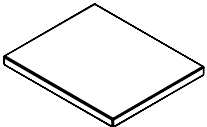
	Part number	H	W	D	Wt (lbs)	Grade A/ base price	Grade B/ COM	Grade C	Grade D	Grade E	Grade F
	<b>CSH15X188X075L</b>	¾"	15"	18 ¾"	5	\$162	—	—	—	—	—
	<b>CSH15X228X075L</b>	¾"	15"	22 ¾"	6	\$169	—	—	—	—	—
	<b>CSH15X288X075L</b>	¾"	15"	28 ¾"	12	\$179	—	—	—	—	—

15"w Lite Pedestal  
Cushion  
(9900 Series)

	<b>CSH15X18X125</b>	1 ¼"	15"	18"	5	\$275	+\$57	+\$103	+\$145	+\$174	+\$249
	<b>CSH15X22X125</b>	1 ¼"	15"	22"	6	\$281	+\$57	+\$103	+\$145	+\$174	+\$249
	<b>CSH15X28X125</b>	1 ¼"	15"	28"	13	\$291	+\$57	+\$103	+\$145	+\$174	+\$249

15"W Classic  
Pedestal Cushion  
(Planna, Storage  
with Handles, Grid  
pedestals)

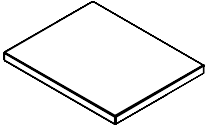
	<b>CSH15X18.75X125</b>	1 ¼"	15"	18 ¾"	8	\$276	+\$57	+\$103	+\$145	+\$174	+\$249
	<b>CSH15X22.75X125</b>	1 ¼"	15"	22 ¾"	9	\$282	+\$57	+\$103	+\$145	+\$174	+\$249
	<b>CSH15X28.75X125</b>	1 ¼"	15"	28 ¾"	13	\$292	+\$57	+\$103	+\$145	+\$174	+\$249

15"w Classic  
Pedestal Cushion  
(9900 Series)

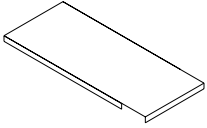
	<b>CSH15X36X125</b>	1 ¼"	15"	36"	15	\$315	+\$57	+\$103	+\$145	+\$174	+\$249
---	---------------------	------	-----	-----	----	-------	-------	--------	--------	--------	--------

36" d Classic  
Pedestal Cushion  
(for back to back  
Planna, Storage  
with Handles, Grid  
pedestal application)

- The Classic Cushion is 1 ¼" thick CAL 117 compliant polyurethane foam with a 2.3 lb/ft. density. This upholstered cushion is balanced with a 7/16" board and is attached to the pedestal top with heavy duty Velcro.
- Cushions may be installed on any storage case
- If optioning a cushion on a Planna case, remove Planna rail
- For application of ALL fabrics, both from our graded program as well as COM (customers own material), please specify layup orientation at time of order. If layup instructions are not provided we will choose the direction to maximize our production.





- Refer to the Finishes Section for additional layout and COM details

**NOTES**





In order to get a total cost on products when upcharges are present take the list price of the product number and add the upcharge cost shown to the list price.

For example:

Product LATCUSH1830SL in Grade C fabric would be \$425 +\$165

	Part number	H	W	D	Wt (lbs)	Grade A/ base price	Grade B/ COM	Grade C	Grade D	Grade E	Grade F
 18" d Classic Lateral Cushion (standard application)	LATCUSH1830SL	1 ¼"	30"	18"	7	\$425	+\$84	+\$165	+\$199	+\$247	+\$363
	LATCUSH1836SL	1 ¼"	36"	18"	8	\$462	+\$97	+\$192	+\$233	+\$287	+\$425
	LATCUSH1842SL	1 ¼"	42"	18"	10	\$501	+\$110	+\$214	+\$267	+\$329	+\$485
	LATCUSH1860SL	1 ¼"	60"	18"	14	\$605	+\$151	+\$296	+\$366	+\$451	+\$664
	LATCUSH1866SL	1 ¼"	66"	18"	15	\$658	+\$177	+\$327	+\$402	+\$495	+\$728
	LATCUSH1872SL	1 ¼"	72"	18"	15	\$713	+\$179	+\$354	+\$436	+\$534	+\$788
	LATCUSH1878SL	1 ¼"	78"	18"	17	\$884	+\$208	+\$408	+\$505	+\$619	+\$909
LATCUSH1884SL	1 ¼"	84"	18"	24	\$832	+\$237	+\$437	+\$584	+\$704	+\$1005	
 19 ¾" d Classic Lateral Cushion (Benching application with electrical)	LATCUSH19830SL	1 ¼"	30"	19 ¾"	7	\$435	+\$84	+\$164	+\$199	+\$246	+\$362
	LATCUSH19836SL	1 ¼"	36"	19 ¾"	8	\$476	+\$96	+\$191	+\$231	+\$286	+\$424
	LATCUSH19842SL	1 ¼"	42"	19 ¾"	10	\$516	+\$108	+\$216	+\$266	+\$328	+\$596
	LATCUSH19860SL	1 ¼"	60"	19 ¾"	14	\$641	+\$151	+\$299	+\$367	+\$452	+\$665
	LATCUSH19866SL	1 ¼"	66"	19 ¾"	15	\$682	+\$166	+\$326	+\$400	+\$494	+\$725
	LATCUSH19872SL	1 ¼"	72"	19 ¾"	15	\$722	+\$144	+\$353	+\$435	+\$534	+\$787
	LATCUSH19878SL	1 ¼"	78"	19 ¾"	17	\$764	+\$135	+\$380	+\$467	+\$576	+\$846
LATCUSH19884SL	1 ¼"	84"	19 ¾"	24	\$806	+\$207	+\$407	+\$503	+\$617	+\$907	
 21 ½" d Classic Lateral Cushion (Private Office application with electrical)	LATCUSH21530SL	1 ¼"	30"	21 ½"	7	\$435	+\$89	+\$170	+\$205	+\$251	+\$368
	LATCUSH21536SL	1 ¼"	36"	21 ½"	8	\$482	+\$96	+\$191	+\$231	+\$286	+\$424
	LATCUSH21542SL	1 ¼"	42"	21 ½"	11	\$518	+\$108	+\$216	+\$265	+\$328	+\$484
	LATCUSH21560SL	1 ¼"	60"	21 ½"	15	\$659	+\$151	+\$296	+\$366	+\$451	+\$664
	LATCUSH21566SL	1 ¼"	66"	21 ½"	16	\$701	+\$165	+\$326	+\$399	+\$492	+\$724
	LATCUSH21572SL	1 ¼"	72"	21 ½"	17	\$746	+\$178	+\$353	+\$434	+\$532	+\$786
	LATCUSH21578SL	1 ¼"	78"	21 ½"	18	\$759	+\$383	+\$383	+\$547	+\$658	+\$939
LATCUSH21584SL	1 ¼"	84"	21 ½"	19	\$793	+\$237	+\$437	+\$584	+\$704	+\$1005	
 36" d Classic Lateral Cushion (back-to-back application)	LATCUSH3630SL	1 ¼"	30"	36"	14	\$524	+\$79	+\$161	+\$192	+\$239	+\$356
	LATCUSH3636SL	1 ¼"	36"	36"	19	\$577	+\$92	+\$187	+\$223	+\$279	+\$415
	LATCUSH3642SL	1 ¼"	42"	36"	19	\$609	+\$105	+\$213	+\$259	+\$321	+\$476
 39 ½" d Classic Lateral Cushion (Back-to-back benching application with electrical)	LATCUSH39530SL	1 ¼"	30"	39 ½"	14	\$532	+\$79	+\$160	+\$191	+\$238	+\$355
	LATCUSH39536SL	1 ¼"	36"	39 ½"	19	\$580	+\$134	+\$212	+\$251	+\$306	+\$445
	LATCUSH39542SL	1 ¼"	42"	39 ½"	19	\$660	+\$105	+\$213	+\$267	+\$319	+\$475

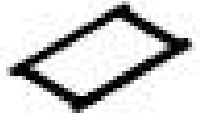
- Planna Storage Support Brackets are shipped as a pair and are both required per Planna Storage worksurface installation
- Hat Channel heights are nominal and they support a standard worksurface height of 28.5"
- Planna Storage rail kits are optional on Planna Storage cases, DO NOT specify if a cushion is to be installed
- Lateral kits install with the rail running the width of the case (side to side)
- Pedestal kits install with the rail running the depth of the case (front to back) EXCEPT for the 18" D which runs side to side
- Planna Storage rails are only available in silver (match to P290 Aluminum Leaf)
- Planna Storage Rail kits include mounting hardware to adhere to the case if ordered separate from Planna Storage case

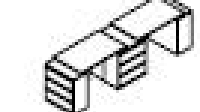
	Part number	W	D	Wt (lbs)	Neutral paint/ base price	Accent paint
 <p>Planna Bracket (pair) Adjustable Height</p>	<b>PSUPBKT</b>	—	—	1	\$92	+\$12
 <p>9" W x 2.89"H Hat Channel For use over Planna case with ½" top with no rail</p>	<b>HATCHNL2.89</b>	2.89"	2	—	\$52	+\$9
 <p>9" W x 2.375"H Hat Channel For use over Planna case with ½" top and ½" rail</p>	<b>HATCHNL2.3759</b>	2.375"	2	—	\$52	+\$9
 <p>Lateral Rail Kit (rails run case width)</p>	<b>PLANNA-KIT30</b>	30"	18"	5	\$161	—
	<b>PLANNA-KIT36</b>	36"	18"	6	\$166	—
	<b>PLANNA-KIT42</b>	42"	18"	6	\$171	—
 <p>Pedestal Rail Kit (rails run case depth)</p>	<b>PLANNA-KIT1518</b>	15"	15"	3	\$156	—
	<b>PLANNA-KIT1522</b>	15"	22"	4	\$161	—
	<b>PLANNA-KIT1528</b>	15"	28"	5	\$166	—
 <p>Rail Kit for collaborative Area (rails run depth of back-to- back cases)</p>	<b>PLANNA-KIT3615</b>	36"	15"	5	\$188	—
	<b>PLANNA-KIT3621</b>	36"	21"	5	\$208	—

## Accessories

Planna Storage  
Pedestals and Lateral Tops

# System



- Planna Storage tops are ½" thick to withstand weight that may be placed on the Planna Storage case
- Various depths and widths have been created for multiple configurations. Refer to drawing in left column for details
- Planna Storage tops are shipped with double sided tape to adhere on the Planna Storage rails

### NOTES

In order to get a total cost on products when upcharges are present take the list price of the product number and add the upcharge cost shown to the list price.

For example:

Product PLN1518 in Nuform Select would be \$86 +\$17

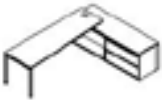
	Part number	W	D	Wt (lbs)	Nuform classic/ base price	Nuform select
	Pedestal Top					
	<b>PLN1518</b>	15"	18"	4	\$86	+\$17
	<b>PLN1522</b>	15"	22"	5	\$111	+\$17
	<b>PLN1528</b>	15"	28"	6	\$138	+\$17
	Single Depth Lateral Top					
	<b>PLN1830</b>	30"	18"	7	\$146	+\$20
	<b>PLN1836</b>	36"	18"	8	\$170	+\$22
	<b>PLN1842</b>	42"	18"	10	\$194	+\$23
	<b>PLN1845</b>	45"	18"	11	\$210	+\$26
	<b>PLN1851</b>	51"	18"	12	\$225	+\$29
	<b>PLN1857</b>	57"	18"	13	\$245	+\$31
	<b>PLN1860</b>	60"	18"	14	\$258	+\$32
	<b>PLN1866</b>	66"	18"	16	\$282	+\$32
	<b>PLN1872</b>	72"	18"	17	\$304	+\$36
	<b>PLN1878</b>	78"	18"	18	\$327	+\$37
	<b>PLN1884</b>	84"	18"	20	\$348	+\$45
<b>PLN1890</b>	90"	18"	21	\$373	+\$43	
<b>PLN1896</b>	96"	18"	23	\$389	+\$50	
	21 ½" D Lateral Top					
	<b>PLNP2130</b>	30"	21 ½"	7	\$165	+\$21
	<b>PLNP2136</b>	36"	21 ½"	8	\$187	+\$23
	<b>PLNP2142</b>	42"	21 ½"	11	\$212	+\$25
	<b>PLNP2145</b>	45"	21 ½"	11	\$228	+\$27
	<b>PLNP2151</b>	51"	21 ½"	13	\$249	+\$30
	<b>PLNP2157</b>	57"	21 ½"	15	\$265	+\$32
	<b>PLNP2160</b>	60"	21 ½"	15	\$285	+\$34
	<b>PLNP2166</b>	66"	21 ½"	16	\$312	+\$37
	<b>PLNP2172</b>	72"	21 ½"	18	\$333	+\$51
	<b>PLNP2178</b>	78"	21 ½"	19	\$358	+\$42
	<b>PLNP2184</b>	84"	21 ½"	21	\$381	+\$48
<b>PLNP2190</b>	90"	21 ½"	23	\$408	+\$61	
<b>PLNP2196</b>	96"	21 ½"	24	\$448	+\$67	

## Accessories

Planna Storage  
Pedestals and Lateral Tops

# System

- Planna Storage tops are ½" thick to withstand weight that may be placed on the Planna Storage case
- Various depths and widths have been created for multiple configurations. Refer to drawing in left column for details
- Planna Storage tops are shipped with double sided tape to adhere on the Planna Storage rails

### NOTES

In order to get a total cost on products when upcharges are present take the list price of the product number and add the upcharge cost shown to the list price.

For example:

Product PLN3630 in Nuform Select would be \$250 +\$39

	Part number	W	D	Wt (lbs)	Nuform classic/ base price	Nuform select	
	Back to Back Depth	<b>PLN3630</b>	30"	36"	14	\$250	+\$39
	Lateral Top	<b>PLN3636</b>	36"	36"	17	\$285	+\$48
		<b>PLN3642</b>	42"	36"	20	\$320	+\$54
		<b>PLN3645</b>	45"	36"	22	\$351	+\$59
		<b>PLN3651</b>	51"	36"	25	\$376	+\$64
		<b>PLN3657</b>	57"	36"	27	\$401	+\$70
		<b>PLN3660</b>	60"	36"	28	\$427	+\$76
		<b>PLN3666</b>	66"	36"	31	\$449	+\$76
		<b>PLN3672</b>	72"	36"	34	\$495	+\$92
		<b>PLN3678</b>	78"	36"	37	\$519	+\$91
		<b>PLN3684</b>	84"	36"	39	\$566	+\$105
		<b>PLN3690</b>	90"	36"	42	\$591	+\$105
	<b>PLN3696</b>	96"	36"	45	\$637	+\$121	



## Accessories

### Planna Storage

Tops to Accommodate Benching Electrical

# System





- Planna Storage tops are ½" thick to withstand weight that may be placed on the Planna Storage case
- Various depths and widths have been created for multiple configurations. Refer to drawing in left column for details
- Planna Storage tops are shipped with double sided tape to adhere on the Planna Storage rails

### NOTES

In order to get a total cost on products when upcharges are present take the list price of the product number and add the upcharge cost shown to the list price.

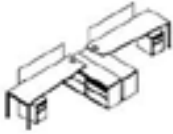
For example:

Product PLNB1930 in Nuform Select would be \$146 +\$20

		Part number	H	W	Wt (lbs)	Nuform classic/ base price	Nuform select
	Single Depth Lateral Top with 1 ¾" D Overhang	<b>PLNB1930</b>	30"	19 ¾"	6	\$146	+\$20
		<b>PLNB1936</b>	36"	19 ¾"	7	\$170	+\$22
		<b>PLNB1942</b>	42"	19 ¾"	8	\$194	+\$23
		<b>PLNB1945</b>	45"	19 ¾"	9	\$212	+\$25
		<b>PLNB1951</b>	51"	19 ¾"	10	\$229	+\$26
		<b>PLNB1957</b>	57"	19 ¾"	11	\$251	+\$27
		<b>PLNB1960</b>	60"	19 ¾"	11	\$258	+\$32
		<b>PLNB1972</b>	72"	19 ¾"	14	\$304	+\$36
		<b>PLNB1984</b>	84"	19 ¾"	14	\$348	+\$45
	Double Depth Back to Back with 3 ½" Additional Depth	<b>PLNB3930</b>	30"	39 ½"	12	\$250	+\$39
		<b>PLNB3936</b>	36"	39 ½"	14	\$285	+\$48
		<b>PLNB3942</b>	42"	39 ½"	16	\$320	+\$54
		<b>PLNB3945</b>	45"	39 ½"	17	\$351	+\$59
		<b>PLNB3951</b>	51"	39 ½"	20	\$386	+\$64
		<b>PLNB3957</b>	57"	39 ½"	22	\$427	+\$76
	Single Depth Lateral Top with 1 ¾" Additional Overhang ½" thick	<b>PLNB1831</b>	31 ¾"	18"	6	\$146	+\$20
		<b>PLNB1837</b>	37 ¾"	18"	7	\$170	+\$22
		<b>PLNB1843</b>	43 ¾"	18"	8	\$194	+\$23
		<b>PLNB1846</b>	46 ¾"	18"	8	\$212	+\$25
		<b>PLNB1852</b>	52 ¾"	18"	9	\$229	+\$26
		<b>PLNB1858</b>	58 ¾"	18"	9	\$251	+\$27
		<b>PLNB1861</b>	61 ¾"	18"	11	\$258	+\$32
		<b>PLNB1873</b>	73 ¾"	18"	13	\$304	+\$36
		<b>PLNB1885</b>	85 ¾"	18"	15	\$348	+\$45
	Double Depth Lateral Top with 1 ¾" Length Overhang	<b>PLNB3631</b>	31 ¾"	36"	11	\$250	+\$39
		<b>PLNB3637</b>	37 ¾"	36"	13	\$285	+\$48
		<b>PLNB3643</b>	43 ¾"	36"	15	\$320	+\$54
		<b>PLNB3646</b>	46 ¾"	36"	16	\$351	+\$59
		<b>PLNB3652</b>	52 ¾"	36"	18	\$375	+\$59
		<b>PLNB3658</b>	58 ¾"	36"	20	\$391	+\$59
		<b>PLNB3661</b>	61 ¾"	36"	22	\$427	+\$76
		<b>PLNB3667</b>	67 ¾"	36"	24	\$449	+\$76
		<b>PLNB3673</b>	73 ¾"	36"	26	\$495	+\$92
		<b>PLNB3679</b>	79 ¾"	36"	28	\$519	+\$91
		<b>PLNB3685</b>	85 ¾"	36"	30	\$566	+\$105
		<b>PLNB3691</b>	91 ¾"	36"	32	\$591	+\$105
		<b>PLNB3697</b>	97 ¾"	36"	34	\$637	+\$121

# **Bench** US Price List

June 2021

**inscape**

work for tomorrow

# Bench Architecture

**inscape**

work for tomorrow

## INSCAPE BENCH SPINE

Inscape Bench spine frames are constructed of 16 gauge tubular steel uprights with welded 18 gauge steel crossrails. This strong yet lightweight construction provides ease of movement and reconfiguration.

The simplicity of the spine structure provides an intelligent solution to cable management. The absence of baseplates, apertures and corner posts eliminate barriers that restrict the routing of cables. Cabling may be routed both vertically and horizontally through the panel. Cables are laid into cable managers that easily install between panel crossrails throughout the framework. Cable managers safely cradle and segregate cables. An aperture free system means installation and reconfiguration costs are kept to a minimum. Reconfiguration is easy and economical. Cabling simply eases out of the cable managers and is laid back in at the desired point, eliminating the costly need to cut and re-terminate cables for every reconfiguration. \*See Inscape Bench Application Guide for quantity of cables achievable in the various spines.

### SPINES

Spines do not include the electrical cover kit but may house power which is to be accessed in alternate locations with a "cutout" tile. The spine comes with one wire manager. Electrical and data components must be specified separately.

Spine glides provide 1.5" height adjustment allowing air to circulate. Spines are available in 6" increments in widths ranging from 30" W to 60" W.

### MID SPINE SUPPORT LEG

A Mid Spine Support Leg must be specified when the Partial Height Spine or the Filing Spine are specified. This leg is a support between two spine frames. There is also a 120° version available. The legs are specific to parallel and 90° applications. The mid spine support legs specific to 90° applications are available in wood, straight metal and T metal styles. The wood style come in Clear Oak (default), Black Oak and Clear Maple finishes. The metal styles are painted and come in all standard options.

### END SPINE SUPPORT LEG

An End Spine Support Leg must be specified at the very end of a Partial Height Spine frame run. This leg is specific to 90° applications. It is available in wood, straight metal and T metal styles. The wood style come in Clear Oak (default), Black Oak and Clear Maple finishes. The metal styles are painted and come in all standard options.

### 90° SPINE SUPPORT LEG

A 90° Spine Support Leg must be specified at the connection point when two Partial Height Benching spine frames are connected at a 90° angle. This leg is specific to 90° applications. It is available in wood and straight metal. The wood style come in Clear Oak (default), Black Oak and Clear Maple finishes. The metal styles are painted and come in all standard options.

## STACK-ON FRAME

The Stack-on Frame consists of a 6.75", 10.125", 13.5", 20.25" and 27" frame which may be installed on any Inscape Bench spine of the same width or combination of two frames as outlined in the Inscape Bench Application Guide only. The Stack-on frame is load bearing and can be stacked one high above spine frame. Tiles and trim are specified separately. Stack-on frames are frame thickness specific and should be specified accordingly.

### DOUBLE GLAZED STACK-ON KIT

Double Glazed Stack-On Kit is a stack-on with a double glazed insert. The 30" to 48" W Double Glazed Stack-on is a fully welded frame stack-on. Double Glazed Stacks which are 54" and wider are kitted and are installed on site. The Double Glazed Stack-on is not load bearing and no stacks can be stacked on top of the Double Glaze. Finishes are available in Clear or Frosted Acrylic to match Double Glazed tile.

## TRIM & CONNECTORS

All Top Caps, End of Line Trim, and Connectors must be specified independently from the frame.

### INLINE CONNECTORS

Inline Connectors are specified to join two units together which are in alignment. These connectors are specified based as INLINE-2 which will connect any of the Inscape Bench spines as well as the stack-ons. Be sure to specify inline connectors for the Stack-ons and Double Glaze Kits separately.

### CONNECTOR TRIM KITS

Connectors are specified independently from the inline connectors and include all necessary brackets and trim for the condition. They are available in two styles; 90° and 120°.

90° corner connectors are used in 90° applications only.

120° connectors are available in "Y" connectors are for 3-way connections and "V" connectors are for 2-way connections.

### TOP CAPS

Top Caps are specified separately. The Top Cap includes clips to mount on spine or Stack-on in addition to the option of spanning two frames as outlined in the Inscape Bench Application Guide.

### END TRIM

End Trim is kit structured to include all brackets, bolts and finished trim; Flat profile. Trim is manufactured from aluminum and always aligns straight and true at end of the Filing spine. All painted aluminum vertical trim and top trim are easily removed to facilitate lay in of cables.

### STACK-ON END TRIM

Stack-on End Trim is used when a higher Stack-on requires vertical end trim at a connection. Hi-Lo trim may be used in this application for Flat profile trim because there is no 'scribing' that is required for this profile.

## TILES

Tiles are available as Fabric, Painted, Tackable, Nuform, Double Glazed, Paper Management and Whiteboard. 13.5" H tiles are interchangeable between Inscape System and Inscape Bench. Tile heights vary and must always align with the spine they are to be installed on.

ie. 23.6" H tiles = Full Height Spine, 10.125" H tiles = Stack-on, 13.5" H tiles = Partial Height and Storage Spine. Tile clips support spine tiles and top trim.

### FABRIC AND PAINTED TILES

Fabric and Painted Tiles are available 23.6", 10.125" and 13.5" H and are constructed of 24 gauge galvanized steel. Powder-coated and fabric-covered steel tiles have a flame spread rating of less than 200 when tested according to ASTM-E84. Fabric-covered tiles are available in standard fabrics or COM. COM fabrics are subject to approval. White or extremely light colored COM fabrics will incur an upcharge of 25% to the tile pricing with which the fabric is being applied. This is due to special handling of the fabric and tiles, in addition to painting of the tiles. Painted tiles are available in the colors shown in our Color Guide and are available in the following styles: plain steel, embossed, perforated, and steel screen. Fabric on tiles is applied in a railroad orientation.

### TACKABLE TILES

Tackable Tiles are constructed from 24 gauge cold rolled steel with a paint finish on all surfaces to prevent corrosion. The same general rules from the fabric tile section apply to the Tackable tiles. Fabric on tiles is applied in a railroad orientation. NRC 0.57, STC 9. Tackable Acoustical tiles are available through Standard Specials with and NRC .73 and an STC of 12.

### NUFORM TILES

Nuform Tiles consist of white melamine-backed MDF substrate 0.375" thick, with vacuum-formed Nuform foil over the front's surface and sides. The back-side of the tile also has routing features that accept zinc die-cast tile clips. All Nuform tiles incorporate a stiffener on the rear of the tile to ensure straightness and rigidity. This stiffener limits where the tile may be placed on the Inscape Bench spine. Nuform tiles cannot be specified in a location where a power track is installed due to interference. A sticker on the back of Nuform tiles provides UL flame/smoke-rating information. Woodgrain pattern is vertical. Due to limitations in the foil size, 48" and wider tiles are not available in F06 Walnut.

## WHITEBOARD TILES

Whiteboard Tiles are available in heights of 13.5". Tiles are constructed from 24 gauge cold rolled steel with a white paint finish that has been specifically formulated for dry erase markers. Whiteboards are seamless and fit same locations as standard painted tiles.

**NOTE: Only Expo Markers are to be used on any Inscape Whiteboard. Whiteboards should be cleaned with Expo Eraser or a Microfiber cleaning cloth along with Expo Cleaning Solution which is formulated to remove residue from Expo Dry Erase Markers.**

## PAPER MANAGEMENT TILES

Paper Management Tiles support horizontal paper management accessories. Organizers may be positioned at any point along the width of the tile. Three slats structured into the tile allow for three different height options for the accessories to be installed. Accessories may be found under Horizontal Accessories under the "Storage and Accessories" section. Maximum load capacity is 75lbs. When specifying paper management tiles which will be supporting a monitor arm, a Paper Management Reinforcing kit is required for additional structure. The 54" and 60" W tiles are pre-structured with these kits.

## PERFORATED AND EMBOSSED TILES

Perforated and Embossed Tiles are constructed of 24 gauge galvanized steel, the Steel Screen Tiles are constructed from 24 gauge cold rolled steel. Tiles may be painted in any of Inscape's standard colors or color matches.

## COMMUNICATION TILES

Communication Tiles provide power OR data access. The 30" W includes one cutout while all wider tile widths include two cutouts. Bezels in tile may be specified in black, white (close match to P168 – Glacier White) and gray (close match to P290 – Aluminum Leaf) as well with the data or electrical components. Bezels are flush with tile, NOT recessed.

**MULTI-ACCESS TILES**

Multi-access Tiles provide electrical AND data access. Cutouts align with power track and proper tiles must be specified in specific areas if stated. Data and Electrical components may be specified from the Technology section. Bezels in tile may be specified in black, white (close match to P168 – Glacier White) and gray (close match to P290 – Aluminum Leaf) as well with the data or electrical components. Bezels are flush with tile, NOT recessed.



**COMMUNICATION AND MULTI-ACCESS TILES WITH SINGLE SIDED CUTOUTS**

Communication and multi-access tiles with single sided cutouts have one cutout per tile (or two above each other for multi-access) and the cutouts are left or right justified making the tiles handed. They are intended to be specified so that the cutouts are hidden below the worksurface. Use one left and one right hand collaborative communication tile for each Bench Collaborative area

**DOUBLE GLAZED TILES**

Double Glazed Tiles are available in 13.5" H and may be installed on frames 24" to 48" W in place of a tile. Double Glazed tiles feature a double pane of frosted acrylic or clear acrylic framed by vertical and horizontal trim. Double Glazed tiles may be installed one on top of another. If wider than 60" of glaze is desired; Stack on Double Glazed kits may be specified.





- 2 ¾" thick spine when clad with tiles
- Power Track Kit (Upper Deck) only - no electrical clips included
- Includes one cable hook
- Bench spine frames come standard with rectangular glides. Black and gray options available

	Part number	H	W	Thickness	List price
	Full Height Benching Spine				
	<b>INBFHF2730</b>	27"	30"	2 ¾"	\$205
	<b>INBFHF2736</b>	27"	36"	2 ¾"	\$210
	<b>INBFHF2742</b>	27"	42"	2 ¾"	\$213
	<b>INBFHF2748</b>	27"	48"	2 ¾"	\$216
	<b>INBFHF2754</b>	27"	54"	2 ¾"	\$220
	<b>INBFHF2760</b>	27"	60"	2 ¾"	\$254
	Partial Height Benching Spine				
	<b>INBPHF13.530</b>	13.5"	30"	2 ¾"	\$167
	<b>INBPHF13.536</b>	13.5"	36"	2 ¾"	\$171
	<b>INBPHF13.542</b>	13.5"	42"	2 ¾"	\$175
	<b>INBPHF13.548</b>	13.5"	48"	2 ¾"	\$179
	<b>INBPHF13.554</b>	13.5"	54"	2 ¾"	\$185
	<b>INBPHF13.560</b>	13.5"	60"	2 ¾"	\$216
	Storage Anchored Benching Spine				
	<b>INBFF30</b>	13.5"	30"	2 ¾"	\$183
	<b>INBFF36</b>	13.5"	36"	2 ¾"	\$187
	<b>INBFF42</b>	13.5"	42"	2 ¾"	\$192
	<b>INBFF48</b>	13.5"	48"	2 ¾"	\$197
	<b>INBFF54</b>	13.5"	54"	2 ¾"	\$200
	<b>INBFF60</b>	13.5"	60"	2 ¾"	\$231

- 2 ¾" thick when clad with tiles
- No Twin Bin placement on the 13.5"H Stack-on
- 20.25"H requires an additional crossrail (separately) if Twin Bin or 13.5"H tile being specified
- Fully welded stack on kits easily installed and removed to adjust panel height
- Load bearing
- Stack on frames may span multiple frames
- See Application Guide for spanning guidelines

**NOTE**

With the exception of the 10.125" H stack-on frame, standard Inscape System tiles can be used for Bench Stack-On frames.

		Part number	H	W	Thickness	List price
	6.75" H Single Stack-On, 2 ¾" T	INSF030-2F	6.75"	30"	2 ¾"	\$162
		INSF036-2F	6.75"	36"	2 ¾"	\$166
		INSF042-2F	6.75"	42"	2 ¾"	\$169
		INSF048-2F	6.75"	48"	2 ¾"	\$174
		INSF054-2F	6.75"	54"	2 ¾"	\$175
		INSF060-2F	6.75"	60"	2 ¾"	\$179
	10.125" H Single Stack-On, 2 ¾" T	INSF1030-2F	10.125"	30"	2 ¾"	\$165
		INSF1036-2F	10.125"	36"	2 ¾"	\$168
		INSF1042-2F	10.125"	42"	2 ¾"	\$171
		INSF1048-2F	10.125"	48"	2 ¾"	\$178
		INSF1054-2F	10.125"	54"	2 ¾"	\$179
		INSF1060-2F	10.125"	60"	2 ¾"	\$183
	13.5" H Single Stack-On, 2 ¾" T	INSF130-2F	13.5"	30"	2 ¾"	\$167
		INSF136-2F	13.5"	36"	2 ¾"	\$170
		INSF142-2F	13.5"	42"	2 ¾"	\$174
		INSF148-2F	13.5"	48"	2 ¾"	\$180
		INSF154-2F	13.5"	54"	2 ¾"	\$183
		INSF160-2F	13.5"	60"	2 ¾"	\$184
	20.25" H Single Stack-On, 2 ¾" T	INSF2030D-2F	20.25"	30"	2 ¾"	\$178
		INSF2036D-2F	20.25"	36"	2 ¾"	\$183
		INSF2042D-2F	20.25"	42"	2 ¾"	\$187
		INSF2048D-2F	20.25"	48"	2 ¾"	\$191
		INSF2054D-2F	20.25"	54"	2 ¾"	\$192
		INSF2060D-2F	20.25"	60"	2 ¾"	\$195
	27" H Single Stack-On, 2 ¾" T	INSF230-2F	27"	30"	2 ¾"	\$195
		INSF236-2F	27"	36"	2 ¾"	\$199
		INSF242-2F	27"	42"	2 ¾"	\$201
		INSF248-2F	27"	48"	2 ¾"	\$207
		INSF254-2F	27"	54"	2 ¾"	\$208
		INSF260-2F	27"	60"	2 ¾"	\$209



- Stack on Double Glaze is non-load bearing
- Stack on Double Glaze may span two frames. See Application Guide for spanning guidelines
- 30" to 48" W kits consist of welded frames
- 54" to 96" W kits are kitted and must be assembled on-site
- Clear and Frosted Acrylic options available
- May be located in the top location only
- Be sure to specify correct thickness of stack-on frame based on the frame it is being installed on

**NOTE**





In order to get a total cost on products when upcharges are present take the list price of the product number and add the upcharge cost shown to the list price.

For example:

Product INSTGL30-2F in Frosted Acrylic would be \$521 +\$92

	Part number	H	W	Thickness	Clear acrylic/ neutral paint/ base price	Frosted acrylic	Accent paint
 <p>13.5" H Double Glaze Stack-On Acrylic</p>	<b>INSTGL30-2F</b>	13.5"	30"	2 3/4"	\$521	+\$92	+\$54
	<b>INSTGL36-2F</b>	13.5"	36"	2 3/4"	\$596	+\$103	+\$61
	<b>INSTGL42-2F</b>	13.5"	42"	2 3/4"	\$645	+\$114	+\$66
	<b>INSTGL48-2F</b>	13.5"	48"	2 3/4"	\$714	+\$126	+\$73
	<b>INSTGL54-2F</b>	13.5"	54"	2 3/4"	\$783	+\$124	+\$83
	<b>INSTGL60-2F</b>	13.5"	60"	2 3/4"	\$862	+\$135	+\$89
	<b>INSTGL66-2F</b>	13.5"	66"	2 3/4"	\$916	+\$160	+\$94
	<b>INSTGL72-2F</b>	13.5"	72"	2 3/4"	\$944	+\$164	+\$97
	<b>INSTGL78-2F</b>	13.5"	78"	2 3/4"	\$974	+\$168	+\$100
	<b>INSTGL84-2F</b>	13.5"	84"	2 3/4"	\$999	+\$171	+\$102
	<b>INSTGL90-2F</b>	13.5"	90"	2 3/4"	\$1030	+\$178	+\$105
	<b>INSTGL96-2F</b>	13.5"	96"	2 3/4"	\$1058	+\$182	+\$107

- Mid spine support legs support the Partial Height Benching spine when it is placed adjacent to another inline
- Glide option on spine support legs are black and gray with the exception on the 90° application legs coming in black only
- Wood spine support legs are available in Clear Oak (default), Black Oak and Clear Maple finishes
- Straight and T metal spine support legs are painted and available in all standard colors
- For freestanding height adjustable 90° applications the Metal T Legs must be use with a Bench Height Adjustable Foot Docking Bracket.  
*\*See Worksurface Support section of this price list*
- The Height Adjustable Tables (2 or 3 stage base) found in the Ergonomic Price List are compatible with 90° applications in 48", 54" and 60" widths only

		Part number	H	Neutral paint/ base price	Accent paint
	Mid Spine Support Leg for parallel applications only	<b>INBMSL10</b>	10"	\$248	+\$27
	Straight Wood Partial Height Bench Frame Mid Spine Support Leg for 90° applications only	<b>INBMSLW10</b>	10"	\$292	—
	Metal T Partial Height Bench Frame Mid Spine Support Leg for 90° applications only	<b>INBMSLT10</b>	10"	\$385	+\$42
	Straight Metal Partial Height Bench Frame Mid Spine Support Leg for 90° applications only	<b>INBMSLSM10</b>	10"	\$248	+\$27



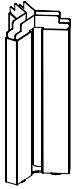

- Mid spine support legs support the Partial Height Benching spine when it is placed adjacent to another inline
- Glide option on spine support legs are black and gray with the exception on the 90° application legs coming in black only
- Straight and T metal spine support legs are painted and available in all standard colors





120° Mid Spine Support Leg

Part number	H	Neutral paint/ base price	Accent paint
<b>INBYMSL10</b>	10"	\$248	+\$27

- End spine support leg supports the very end Partial Height Benching spine run
- 90° spine support legs supports the connection point when two Partial Height Benching spine frames are connected at a 90° angle
- Glide option on spine support legs is black
- Wood spine support legs are available in Clear Oak (default), Black Oak and Clear Maple finishes
- Straight and T metal spine support legs are painted and available in all standard colors
- Metal 90° spine support legs are intended to be installed on the worksurface supporting spine
- Metal 90° spine support legs are shipped right handed. if left handed is required, the legs can be field adjusted

		Part number	H	Neutral paint/ base price	Accent paint
	Straight Wood Partial Height Bench Frame End Spine Support Leg for 90° applications only	<b>INBESLW10</b>	10"	\$292	—
	Metal T Partial Height Bench Frame End Spine Support Leg for 90° applications only	<b>INBESLT10</b>	10"	\$357	+\$37
	Straight Metal Partial Height Bench Frame End Spine Support Leg for 90° applications only	<b>INBESLSM10</b>	10"	\$248	+\$27
	Straight Wood Partial Height Bench Frame 90° Spine Support Leg for 90° applications only	<b>INB90SLW10</b>	10"	\$292	—
	Straight Metal Partial Height Bench Frame 90° Spine Support Leg for 90° applications only	<b>INB90SLSM10</b>	10"	\$248	+\$27

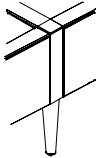
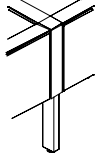
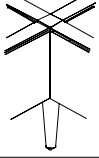
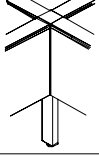
- Glide option on spine support legs is black
- Wood spine support legs are available in Clear Oak (default), Black Oak and Clear Maple finishes
- Metal spine support legs are painted and available in all standard colors
- 3-Way and 4-Way spine support legs are non-handed
- For freestanding height adjustable 90° applications the Metal T Legs must be use with a Bench Height Adjustable Foot Docking Bracket. See Worksurface Support setion of this price list
- The Height Adjustable Tables (2 or 3 stage base) found in the Ergonomic Price List are compatible with 90° applications in 48", 54" and 60" widths only

		Part number	H	Neutral paint/ base price	Accent paint
	3-Way Wood Partial Height Bench Frame Spine Support Leg for Mobile applications only	<b>INB3SLW10</b>	10"	\$288	—
	3-Way Metal Partial Height Bench Frame Spine Support Leg for Mobile applications only	<b>INB3SLSM10</b>	10"	\$228	+\$24
	4-Way Wood Partial Height Bench Frame Spine Support Leg for Mobile applications only	<b>INB4SLW10</b>	10"	\$316	—
	4-Way Metal Partial Height Bench Frame Spine Support Leg for Mobile applications only	<b>INB4SLSM10</b>	10"	\$262	+\$27
	Freestanding Bench Spine Floor Docking Bracket	<b>INBLAKESTBKT</b>	—	\$17	—

- Inline Connectors are required to be specified when frames are connected inline
- Specified independently of frame and may span two frames.
- See Inscape System Application Guide
- All mounting hardware is included for corresponding frame thickness
- Top Trim up to 60" W requires two additional Jesters to be specified if spanning multiple frames (i.e. a 60" W top trim installed on two 30" frames)
- Stack-on End Trim (Hi-Lo End Trim) is specified when stack frames are specified





- End of line trim is specified when storage is being specified and there is visibility to the end of the frame (all other end conditions include finished appearance with no end trim needed)
- End of line trim can not be used on a stack on frame

**NOTE**

In order to get a total cost on products when upcharges are present take the list price of the product number and add the upcharge cost shown to the list price.

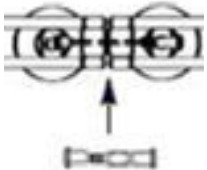
For example:

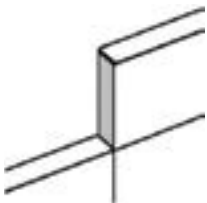

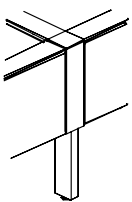
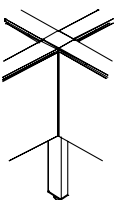

Product INTC30-2F in an accent paint would be \$60 +\$9

	Part number	H			List price		
	Inline Connector Kit	<b>INLINE-1</b>	All Stack on Frame			\$0	
		<b>INLINE-2</b>	24"h - 51"h Frame			\$0	
	Part number	H	W	Thickness	Flat/neutral paint/ base price	Accent paint	
	Top Cap	<b>INTC30-2F</b>	—	30"	2 ¾"	\$60	+\$9
		<b>INTC36-2F</b>	—	36"	2 ¾"	\$65	+\$10
		<b>INTC42-2F</b>	—	42"	2 ¾"	\$71	+\$10
		<b>INTC48-2F</b>	—	48"	2 ¾"	\$73	+\$11
		<b>INTC54-2F</b>	—	54"	2 ¾"	\$91	+\$12
		<b>INTC60-2F</b>	—	60"	2 ¾"	\$97	+\$13
		<b>INTC66-2F</b>	—	66"	2 ¾"	\$112	+\$15
		<b>INTC72-2F</b>	—	72"	2 ¾"	\$118	+\$15
		<b>INTC78-2F</b>	—	78"	2 ¾"	\$126	+\$16
		<b>INTC84-2F</b>	—	84"	2 ¾"	\$137	+\$17
		<b>INTC90-2F</b>	—	90"	2 ¾"	\$141	+\$17
	<b>INTC96-2F</b>	—	96"	2 ¾"	\$144	+\$18	
	Hi-Lo End Trim	<b>INETHL6.75-2F</b>	6.75"	—	2 ¾"	\$27	+\$7
		<b>INBET10.125-2F</b>	10.125"	—	2 ¾"	\$34	+\$7
		<b>INETHL13.5-2F</b>	13.5"	—	2 ¾"	\$43	+\$8
		<b>INETHL20.25-2F</b>	20.25"	—	2 ¾"	\$51	+\$9
		<b>INETHL27-2F</b>	27"	—	2 ¾"	\$79	+\$11
	End Trim For use with 2 ¾" T frames	<b>INBET13.5-2F</b>	13.5"	—	2 ¾"	\$39	+\$8
		For use with Partial Height Frames					
	<b>INBETEND27-2F</b>	25.61"	—	2 ¾"	\$53	+\$9	
	For use with Full Height Frames						

- Connector Kits include connector brackets, bolts, nuts and finished trim to create connection
- Connectors and trim are available in all of Inscape's standard paint colors
- Specify code based on height of frames within connection

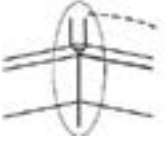

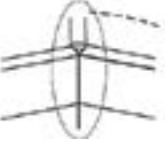
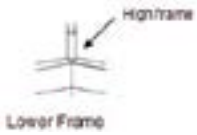

		Part number	H	Neutral paint/ base price	Accent paint
	90° Corner Connector for 90° applications only	<b>INBCPLC13.5-2F</b> with rounded profile	13.5"	\$67	+\$10
		<b>INBCPLS13.5-2F</b> with straight profile	13.5"	\$67	+\$10
	3-Way Corner Connector for Mobile applications only	<b>INBCPT13.5-2F</b>	13.5"	\$106	+\$12
	4-Way Corner Connector for Mobile applications only	<b>INBCPX13.5-2F</b>	13.5"	\$46	+\$6

- Connector Kits include connector brackets, bolts, nuts and finished trim to create connection
- Connectors and trim are available in all of Inscape's standard paint colors
- Specify code based on height of frames within connection
- Full Height to Partial Height Spine Trim finishes the full height bench frame when adjacent (inline) to a partial height spine frame

		Part number	H	Neutral paint/ base price	Accent paint
	120° Y Connector, Partial Height 2 3/4" Thick Frame - same height configurations	<b>INCPYBPH-2F</b>	13.5"	\$77	+\$11
		<b>INCPYBFH-2F</b>	27"	\$168	+\$20
	120° Stack-On "V" Connector	<b>INCPV6.75-2F</b>	6.75"	\$180	+\$21
		<b>INCPV10-2F</b>	10.125"	\$185	+\$21
		<b>INCPV13.5-2F</b>	13.5"	\$189	+\$22
	120° Stack-On "Y" Connector	<b>INCPY6.75-2F</b>	6.75"	\$20	+\$6
		<b>INCPY10-2F</b>	10.125"	\$22	+\$6
		<b>INCPY13.5-2F</b>	13.5"	\$25	+\$6
	120° Stack-On End Trim, Multi Height	<b>INST6.75Y-2F</b>	6.75"	\$180	+\$21
		<b>INST10Y-2F</b>	10.125"	\$185	+\$21
		<b>INST13.5Y-2F</b>	13.5"	\$189	+\$22
	Full Height to Partial Height Spine Trim	<b>INBPFHETC10</b>	10"	\$76	+\$10



- 23.6" H tiles may only be mounted on Full Height Bench spine
- Multi-access Tiles include cutouts for power and data
- Communication Tiles include cutouts for power or data
- Collaborative tiles have one cutout per tile and the cutouts are left or right justified making the tiles handed. They are intended to be specified to hide below the worksurface. Use one left and one right hand for each Bench Collaborative area

		Part number	H	W	Neutral paint/ base price	Accent paint
	23.6" H Painted Tile	<b>INB23.6P30</b>	23.625"	30"	\$96	+\$12
		<b>INB23.6P36</b>	23.625"	36"	\$112	+\$15
		<b>INB23.6P42</b>	23.625"	42"	\$120	+\$16
		<b>INB23.6P48</b>	23.625"	48"	\$135	+\$17
		<b>INB23.6P54</b>	23.625"	54"	\$145	+\$18
		<b>INB23.6P60</b>	23.625"	60"	\$168	+\$20
	23.6" H Painted Communication Tile	<b>INB23.6CTP30</b>	23.625"	30"	\$178	+\$21
		<b>INB23.6CTP36</b>	23.625"	36"	\$183	+\$21
		<b>INB23.6CTP42</b>	23.625"	42"	\$194	+\$22
		<b>INB23.6CTP48</b>	23.625"	48"	\$204	+\$23
		<b>INB23.6CTP54</b>	23.625"	54"	\$225	+\$25
		<b>INB23.6CTP60</b>	23.625"	60"	\$229	+\$25
	23.6" H Painted Multi Access Tile	<b>INB23.6MAP30</b>	23.625"	30"	\$178	+\$21
		<b>INB23.6MAP36</b>	23.625"	36"	\$183	+\$21
		<b>INB23.6MAP42</b>	23.625"	42"	\$194	+\$22
		<b>INB23.6MAP48</b>	23.625"	48"	\$204	+\$23
		<b>INB23.6MAP54</b>	23.625"	54"	\$225	+\$25
		<b>INB23.6MAP60</b>	23.625"	60"	\$229	+\$25
	23.6" H Painted Collaborative Communication Tile with single sided cutouts	<b>INBCLB23CTP36UL</b>	23.625"	36"	\$171	+\$20
		<b>INBCLB23CTP42UL</b> cutout on the left (illustrated)	23.625"	42"	\$179	+\$21
		<b>INBCLB23CTP36UR</b>	23.625"	36"	\$171	+\$20
		<b>INBCLB23CTP42UR</b> cutout on the right	23.625"	42"	\$179	+\$21

	Part number	H	W	Grade 1/ COM/ base price	Grade 2	Grade 3	Grade 4	Grade 5	Grade 6	Grade 7	Grade 8	Scrim
	<b>INBCLB23CTF36UL</b>	23.625"	36"	\$173	+\$11	+\$23	+\$35	+\$49	+\$85	+\$119	+\$166	+\$31
	<b>INBCLB23CTF42UL</b> cutout on the left (illustrated)	23.625"	42"	\$177	+\$13	+\$26	+\$37	+\$51	+\$88	+\$124	+\$171	+\$34
	<b>INBCLB23CTF36UR</b>	23.625"	36"	\$173	+\$11	+\$23	+\$35	+\$49	+\$85	+\$119	+\$166	+\$31
	<b>INBCLB23CTF42UR</b> cutout on the right	23.625"	42"	\$177	+\$13	+\$26	+\$37	+\$51	+\$88	+\$124	+\$171	+\$34

23.6" H Fabric Collaborative Communication Tile with single sided cutouts

- 13.5" H tile may be specified with Partial Height Spine or Filing Spine
- Tiles are standard 13.5" H Inscape System
- 13.5" H Tiles may be specified on 13.5" stack on frame
- Tiles 66" W or wide span two frames. See Application Guide for frame spanning guidelines

**NOTE**

See finishes section for fabrics that require scrim  
Tile size limitations exist for some fabrics, see finishes section  
In order to get a total cost on products when upcharges are present take the list price of the product number and add the upcharge cost shown to the list price.

For example:

Product IN13.5F18 in a Grade 5 Fabric with Scrim would be \$98 +\$31 +\$16

	Part number	H	W	Neutral paint/base price	Accent paint	
	13.5" H Painted Tile	<b>IN13.5P30</b>	13.5"	30"	\$71	+\$10
		<b>IN13.5P36</b>	13.5"	36"	\$72	+\$11
		<b>IN13.5P42</b>	13.5"	42"	\$74	+\$11
		<b>IN13.5P48</b>	13.5"	48"	\$77	+\$11
		<b>IN13.5P54</b>	13.5"	54"	\$81	+\$11
		<b>IN13.5P60</b>	13.5"	60"	\$86	+\$12

	13.5" H Perforated Tile	<b>IN13.5PF30</b>	13.5"	30"	\$86	+\$12
		<b>IN13.5PF36</b>	13.5"	36"	\$87	+\$12
		<b>IN13.5PF42</b>	13.5"	42"	\$88	+\$12
		<b>IN13.5PF48</b>	13.5"	48"	\$91	+\$12
		<b>IN13.5PF54</b>	13.5"	54"	\$92	+\$12
		<b>IN13.5PF60</b>	13.5"	60"	\$94	+\$12

	Part number	H	W	Grade 1/ COM/ base price	Grade 2	Grade 3	Grade 4	Grade 5	Grade 6	Grade 7	Grade 8	Scrim	
	13.5" H Fabric Tile	<b>IN13.5F18</b>	13.5"	18"	\$98	+\$7	+\$22	+\$24	+\$31	+\$46	+\$61	+\$87	+\$16
		<b>IN13.5F24</b>	13.5"	24"	\$101	+\$7	+\$24	+\$27	+\$34	+\$45	+\$60	+\$86	+\$16
		<b>IN13.5F30</b>	13.5"	30"	\$105	+\$8	+\$26	+\$33	+\$37	+\$45	+\$61	+\$87	+\$17
		<b>IN13.5F36</b>	13.5"	36"	\$110	+\$12	+\$26	+\$35	+\$45	+\$67	+\$92	+\$128	+\$17
		<b>IN13.5F42</b>	13.5"	42"	\$116	+\$15	+\$27	+\$36	+\$47	+\$72	+\$98	+\$135	+\$18
		<b>IN13.5F48</b>	13.5"	48"	\$120	+\$15	+\$27	+\$36	+\$47	+\$72	+\$99	+\$137	+\$18
		<b>IN13.5F54</b>	13.5"	54"	\$124	+\$16	+\$29	+\$42	+\$52	+\$81	+\$106	+\$147	+\$20
		<b>IN13.5F60</b>	13.5"	60"	\$129	+\$16	+\$29	+\$42	+\$52	+\$81	+\$106	+\$147	+\$20
		<b>IN13.5F66</b>	13.5"	66"	\$239	+\$17	+\$29	+\$42	+\$52	+\$83	+\$107	+\$151	+\$93
		<b>IN13.5F72</b>	13.5"	72"	\$243	+\$17	+\$18	+\$25	+\$33	+\$66	+\$99	+\$137	+\$94
		<b>IN13.5F78</b>	13.5"	78"	\$245	+\$17	+\$20	+\$27	+\$35	+\$71	+\$105	+\$146	+\$94
		<b>IN13.5F84</b>	13.5"	84"	\$255	+\$18	+\$20	+\$27	+\$35	+\$71	+\$105	+\$146	+\$96
	<b>IN13.5F90</b>	13.5"	90"	\$256	+\$18	+\$21	+\$31	+\$42	+\$77	+\$112	+\$157	+\$118	
	<b>IN13.5F96</b>	13.5"	96"	\$259	+\$19	+\$22	+\$33	+\$45	+\$84	+\$119	+\$166	+\$118	

	13.5" H Tackable Tile	<b>IN13.5TK18</b>	13.5"	18"	\$145	+\$7	+\$11	+\$20	+\$29	+\$51	+\$73	+\$102	+\$25
		<b>IN13.5TK24</b>	13.5"	24"	\$151	+\$8	+\$12	+\$21	+\$29	+\$52	+\$74	+\$103	+\$27
		<b>IN13.5TK30</b>	13.5"	30"	\$156	+\$9	+\$12	+\$21	+\$29	+\$53	+\$77	+\$106	+\$29
		<b>IN13.5TK36</b>	13.5"	36"	\$160	+\$12	+\$22	+\$32	+\$44	+\$73	+\$103	+\$143	+\$30
		<b>IN13.5TK42</b>	13.5"	42"	\$165	+\$13	+\$23	+\$33	+\$45	+\$76	+\$106	+\$147	+\$32
		<b>IN13.5TK48</b>	13.5"	48"	\$187	+\$13	+\$23	+\$35	+\$48	+\$84	+\$115	+\$161	+\$33

# Architecture

Tiles  
Partial Height Spine Tiles

# Bench

- 13.5" H tile may be specified with Partial Height Spine or Filing Spine
- Tiles are standard 13.5" H Inscape System
- May be specified on Stack-on Frame
- When specifying monitor arms to mount on paper management tile, reinforcing bracket must be specified
- Reinforcement Kit includes reinforcing brackets for Paper Management Tile

		Part number	H	W	Nuform Classic/ List/base price	Nuform Select
	13.5" H Nuform Tile	<b>IN13.5NF30</b>	13.5"	30"	\$263	+\$30
		<b>IN13.5NF36</b>	13.5"	36"	\$274	+\$31
		<b>IN13.5NF42</b>	13.5"	42"	\$286	+\$33
		<b>IN13.5NF48</b>	13.5"	48"	\$293	+\$33

		Part number	H	W		
	13.5" H Whiteboard Tile	<b>IN13.5WB30</b>	13.5"	30"	\$103	—
		<b>IN13.5WB36</b>	13.5"	36"	\$105	—
		<b>IN13.5WB42</b>	13.5"	42"	\$107	—
		<b>IN13.5WB48</b>	13.5"	48"	\$114	—
		<b>IN13.5WB54</b>	13.5"	54"	\$127	—
		<b>IN13.5WB60</b>	13.5"	60"	\$132	—
		<b>IN13.5WB66</b>	13.5"	66"	\$227	—
		<b>IN13.5WB72</b>	13.5"	72"	\$234	—
		<b>IN13.5WB78</b>	13.5"	78"	\$245	—
		<b>IN13.5WB84</b>	13.5"	84"	\$250	—
		<b>IN13.5WB90</b>	13.5"	90"	\$255	—
<b>IN13.5WB96</b>	13.5"	96"	\$262	—		

		Part number	H	W	Neutral paint/ base price	Accent paint
	6.75" H Paper Management Tile for use with 2 3/4" T frames	<b>IN6.75PM30-2F</b>	6.75"	30"	\$160	+\$19
		<b>IN6.75PM36-2F</b>	6.75"	36"	\$174	+\$20
		<b>IN6.75PM42-2F</b>	6.75"	42"	\$195	+\$22
		<b>IN6.75PM48-2F</b>	6.75"	48"	\$211	+\$23
		<b>IN6.75PM54-2F</b>	6.75"	54"	\$227	+\$25
		<b>IN6.75PM60-2F</b>	6.75"	60"	\$249	+\$27
		<b>IN6.75PM66-2F</b>	6.75"	66"	\$328	+\$34
		<b>IN6.75PM72-2F</b>	6.75"	72"	\$341	+\$36
		<b>IN6.75PM78-2F</b>	6.75"	78"	\$353	+\$37
		<b>IN6.75PM84-2F</b>	6.75"	84"	\$401	+\$44
		<b>IN6.75PM90-2F</b>	6.75"	90"	\$414	+\$45
<b>IN6.75PM96-2F</b>	6.75"	96"	\$429	+\$46		

	Paper Management Reinforcing Kit for use with 2 3/4" T frames	<b>INPMRK-2F</b>	—	18"	\$126	—
---	---	------------------	---	-----	-------	---





# Architecture

## Tiles

### Partial Height Spine Tiles

# Bench

- 13.5" H tile may be specified with Partial Height Spine or Filing Spine
- Tiles are standard 13.5" H Inscape System
- 13.5" H tiles may be specified on 13.5" Stack-on Frame
- Multi-access Tiles include cutouts for power and data
- Communication Tiles include cutouts for power or data
- Collaborative communication and multi-access tiles with single sided cutouts have one cutout per tile (2 stacked for multi-access) and the cutouts are left or right justified making the tiles handed. They are intended to be specified so that the cutouts are hidden below the worksurface
- Use one left and one right hand collaborative communication tile for each Bench Collaborative area





		Part number	H	W	Neutral paint/ base price	Accent paint	
	13.5" H Painted Communication Tile Upper Deck Location	<b>IN13.5CTP24-UD</b>	13.5"	24"	\$99	+\$13	
		<b>IN13.5CTP30-UD</b>	13.5"	30"	\$102	+\$13	
		<b>IN13.5CTP36-UD</b>	13.5"	36"	\$107	+\$15	
		<b>IN13.5CTP42-UD</b>	13.5"	42"	\$112	+\$15	
		<b>IN13.5CTP48-UD</b>	13.5"	48"	\$119	+\$15	
		<b>IN13.5CTP54-UD</b>	13.5"	54"	\$120	+\$16	
		<b>IN13.5CTP60-UD</b>	13.5"	60"	\$124	\$124	
	13.5" H Painted Multi Access Tile	<b>IN13.5MAP30-UD</b>	13.5"	30"	\$103	+\$13	
		<b>IN13.5MAP36-UD</b>	13.5"	36"	\$107	+\$15	
		<b>IN13.5MAP42-UD</b>	13.5"	42"	\$112	+\$15	
		<b>IN13.5MAP48-UD</b>	13.5"	48"	\$119	+\$15	
		<b>IN13.5MAP54-UD</b>	13.5"	54"	\$120	+\$16	
		<b>IN13.5MAP60-UD</b>	13.5"	60"	\$124	+\$16	
	13.5" H Painted Collaborative Communication Tile with single sided cutouts	<b>INBCLB13CTP36UL</b>	13.5"	36"	\$96	+\$12	
		<b>INBCLB13CTP42UL</b>	13.5"	42"	\$101	+\$13	
		cutout on the left (illustrated)					
		<b>INBCLB13CTP36UR</b>	13.5"	36"	\$96	+\$12	
		<b>INBCLB13CTP42UR</b>	13.5"	42"	\$101	+\$13	
cutout on the right							
	13.5" H Painted Multi Access Tile with single sided cutouts	<b>IN13.5MAP60UL</b>	13.5"	60"	\$124	+\$16	
		<b>IN13.5MAP72UL</b>	13.5"	72"	\$239	+\$26	
		cutout on the left (illustrated)					
		<b>IN13.5MAP60UR</b>	13.5"	60"	\$124	+\$16	
		<b>IN13.5MAP72UR</b>	13.5"	72"	\$239	+\$26	
		cutout on the right					

- 13.5" H tile may be specified with Partial Height Spine or Filing Spine
- Tiles are standard 13.5" H Inscape System
- 13.5" H tiles may be specified on 13.5" Stack-on Frame
- Multi-access Tiles include cutouts for power and data
- Communication Tiles include cutouts for power or data
- Collaborative communication and multi-access tiles with single sided cutouts have one cutout per tile (2 stacked for multi-access) and the cutouts are left or right justified making the tiles handed. They are intended to be specified so that the cutouts are hidden below the worksurface
- Use one left and one right hand collaborative communication tile for each Bench Collaborative area

**NOTE**

See finishes section for fabrics that require scrim  
Tile size limitations exist for some fabrics, see finishes section  
In order to get a total cost on products when upcharges are present take the list price of the product number and add the upcharge cost shown to the list price.

For example:  
Product IN13.5CTF24-UD in a Grade 5 Fabric with Scrim would be \$114 +\$31 +\$16

	Part number	H	W	Grade 1/ COM/ base price	Grade 2	Grade 3	Grade 4	Grade 5	Grade 6	Grade 7	Grade 8	Scrim
 13.5" H Fabric Communication Tile Upper Deck Location	<b>IN13.5CTF24-UD</b>	13.5"	24"	\$114	+\$9	+\$15	+\$23	+\$31	+\$54	+\$79	+\$108	+\$16
	<b>IN13.5CTF30-UD</b>	13.5"	30"	\$119	+\$8	+\$12	+\$21	+\$29	+\$53	+\$77	+\$106	+\$17
	<b>IN13.5CTF36-UD</b>	13.5"	36"	\$131	+\$9	+\$16	+\$27	+\$39	+\$69	+\$98	+\$135	+\$17
	<b>IN13.5CTF42-UD</b>	13.5"	42"	\$134	+\$10	+\$20	+\$29	+\$37	+\$71	+\$100	+\$140	+\$18
	<b>IN13.5CTF48-UD</b>	13.5"	48"	\$139	+\$12	+\$25	+\$35	+\$46	+\$76	+\$106	+\$147	+\$18
	<b>IN13.5CTF54-UD</b>	13.5"	54"	\$140	+\$13	+\$27	+\$39	+\$50	+\$84	+\$114	+\$160	+\$20
	<b>IN13.5CTF60-UD</b>	13.5"	60"	\$153	+\$15	+\$16	+\$27	+\$42	+\$73	+\$105	+\$146	+\$20
 13.5" H Fabric Multi Access Tile Upper Deck Location	<b>IN13.5MAF30-UD</b>	13.5"	30"	\$120	+\$8	+\$12	+\$21	+\$29	+\$53	+\$77	+\$106	+\$17
	<b>IN13.5MAF36-UD</b>	13.5"	36"	\$131	+\$9	+\$16	+\$27	+\$39	+\$69	+\$98	+\$135	+\$17
	<b>IN13.5MAF42-UD</b>	13.5"	42"	\$134	+\$10	+\$23	+\$29	+\$44	+\$72	+\$103	+\$143	+\$18
	<b>IN13.5MAF48-UD</b>	13.5"	48"	\$139	+\$12	+\$25	+\$35	+\$46	+\$76	+\$106	+\$147	+\$18
	<b>IN13.5MAF54-UD</b>	13.5"	54"	\$140	+\$13	+\$27	+\$39	+\$50	+\$84	+\$114	+\$160	+\$20
	<b>IN13.5MAF60-UD</b>	13.5"	60"	\$153	+\$15	+\$30	+\$43	+\$52	+\$87	+\$116	+\$162	+\$20
 13.5" H Fabric Collaborative Communication Tile with single sided cutouts	<b>INBCLB13CTF36UL</b>	13.5"	36"	\$119	+\$8	+\$15	+\$26	+\$37	+\$66	+\$96	+\$132	+\$16
	<b>INBCLB13CTF42UL</b>	13.5"	42"	\$125	+\$9	+\$19	+\$27	+\$43	+\$69	+\$99	+\$137	+\$17
	<b>INBCLB13CTF36UR</b>	13.5"	36"	\$119	+\$8	+\$15	+\$26	+\$37	+\$66	+\$96	+\$132	+\$16
	<b>INBCLB13CTF42UR</b>	13.5"	42"	\$125	+\$9	+\$19	+\$27	+\$43	+\$69	+\$99	+\$137	+\$17
 13.5" H Fabric Multi Access Tile with single sided cutouts	<b>IN13.5MAF60UL</b>	13.5"	60"	\$153	+\$16	+\$29	+\$42	+\$52	+\$81	+\$106	+\$147	+\$20
	<b>IN13.5MAF72UL</b>	13.5"	72"	\$295	+\$26	+\$53	+\$74	+\$98	+\$151	+\$201	+\$281	+\$54
	<b>IN13.5MAF60UR</b>	13.5"	60"	\$153	+\$16	+\$29	+\$42	+\$52	+\$81	+\$106	+\$147	+\$20
	<b>IN13.5MAF72UR</b>	13.5"	72"	\$295	+\$26	+\$53	+\$74	+\$98	+\$151	+\$201	+\$281	+\$54

- Tiles may only be installed on 10.125" H Stack-on
- May be specified on a Stack-on Frame
- Multi-access Tiles include cutouts for power and data
- Communication Tiles include cutouts for power or data



**NOTE**

See finishes section for fabrics that require scrim  
 Tile size limitations exist for some fabrics, see finishes section

In order to get a total cost on products when upcharges are present take the list price of the product number and add the upcharge cost shown to the list price.

For example:

Product IN10.125F30 in a Grade 5 Fabric with Scrim would be \$105 +\$26 +\$17

		Part number	H	W	Neutral paint/ base price	Accent paint
	10.125" H Painted Tile	<b>IN10.125P30</b>	10.125"	30"	\$71	+\$10
		<b>IN10.125P36</b>	10.125"	36"	\$72	+\$11
		<b>IN10.125P42</b>	10.125"	42"	\$74	+\$11
		<b>IN10.125P48</b>	10.125"	48"	\$77	+\$11
		<b>IN10.125P54</b>	10.125"	54"	\$81	+\$11
		<b>IN10.125P60</b>	10.125"	60"	\$86	+\$12
	10.125" H Painted Multi-Access Tile	<b>IN10.12MAP30-UD</b>	10.125"	30"	\$102	+\$13
		<b>IN10.12MAP36-UD</b>	10.125"	36"	\$107	+\$15
		<b>IN10.12MAP42-UD</b>	10.125"	42"	\$112	+\$15
		<b>IN10.12MAP48-UD</b>	10.125"	48"	\$119	+\$15
		<b>IN10.12MAP54-UD</b>	10.125"	54"	\$120	+\$16
		<b>IN10.12MAP60-UD</b>	10.125"	60"	\$124	+\$16
	10.125" H Painted Communication Tile	<b>IN10.12CTP30-UD</b>	10.125"	30"	\$102	+\$13
		<b>IN10.12CTP36-UD</b>	10.125"	36"	\$107	+\$15
		<b>IN10.12CTP42-UD</b>	10.125"	42"	\$112	+\$15
		<b>IN10.12CTP48-UD</b>	10.125"	48"	\$119	+\$15
		<b>IN10.12CTP54-UD</b>	10.125"	54"	\$120	+\$16
		<b>IN10.12CTP60-UD</b>	10.125"	60"	\$124	+\$16

- Tiles may only be installed on 10.125" H Stack on
- May be specified on a Stack-On Frame
- Multi Access Tiles include cutouts for power and data
- Communication Tiles include cutouts for power or data

**NOTE**



See finishes section for fabrics that require scrim

Tile size limitations exist for some fabrics, see finishes section

In order to get a total cost on products when upcharges are present take the list price of the product number and add the upcharge cost shown to the list price.

For example:

Product IN10.125F30 in a Grade 5 Fabric with Scrim would be \$105 +\$26 +\$17

	Part number	H	W	Grade 1/ COM/ base price	Grade 2	Grade 3	Grade 4	Grade 5	Grade 6	Grade 7	Grade 8	Scrim
 10.125" H Fabric Tile	<b>IN10.125F30</b>	10.125"	30"	\$105	+\$8	+\$12	—	+\$26	—	+\$61	—	+\$17
	<b>IN10.125F36</b>	10.125"	36"	\$110	+\$12	+\$26	—	+\$45	—	+\$92	—	+\$17
	<b>IN10.125F42</b>	10.125"	42"	\$116	+\$11	+\$27	—	+\$47	—	+\$98	—	+\$18
	<b>IN10.125F48</b>	10.125"	48"	\$120	+\$15	+\$27	—	+\$47	—	+\$99	—	+\$18
	<b>IN10.125F54</b>	10.125"	54"	\$124	+\$16	+\$29	—	+\$52	—	+\$106	—	+\$20
	<b>IN10.125F60</b>	10.125"	60"	\$129	+\$16	+\$29	—	+\$52	—	+\$106	—	+\$20
 10.125" H Fabric Multi-Access Tile	<b>IN10.12MAF30-UD</b>	10.125"	30"	\$119	+\$8	+\$12	—	+\$29	—	+\$77	—	+\$17
	<b>IN10.12MAF36-UD</b>	10.125"	36"	\$131	+\$9	+\$16	—	+\$39	—	+\$98	—	+\$17
	<b>IN10.12MAF42-UD</b>	10.125"	42"	\$134	+\$8	+\$20	—	+\$37	—	+\$98	—	+\$18
	<b>IN10.12MAF48-UD</b>	10.125"	48"	\$139	+\$12	+\$25	—	+\$46	—	+\$106	—	+\$18
	<b>IN10.12MAF54-UD</b>	10.125"	54"	\$140	+\$13	+\$27	—	+\$50	—	+\$114	—	+\$20
	<b>IN10.12MAF60-UD</b>	10.125"	60"	\$153	+\$6	+\$16	—	+\$42	—	+\$105	—	+\$20
 10.125" H Fabric Communication Tile	<b>IN10.12CTF30-UD</b>	10.125"	30"	\$119	+\$8	+\$12	—	+\$29	—	+\$77	—	+\$17
	<b>IN10.12CTF36-UD</b>	10.125"	36"	\$131	+\$9	+\$16	—	+\$39	—	+\$98	—	+\$17
	<b>IN10.12CTF42-UD</b>	10.125"	42"	\$134	+\$8	+\$20	—	+\$37	—	+\$98	—	+\$18
	<b>IN10.12CTF48-UD</b>	10.125"	48"	\$139	+\$12	+\$25	—	+\$46	—	+\$106	—	+\$18
	<b>IN10.12CTF54-UD</b>	10.125"	54"	\$140	+\$13	+\$27	—	+\$50	—	+\$114	—	+\$20
	<b>IN10.12CTF60-UD</b>	10.125"	60"	\$153	+\$6	+\$16	—	+\$42	—	+\$105	—	+\$20

# Bench Technology

**inscape**

work for tomorrow



Inscape Bench electrical is UL and CSA approved. New York City and Chicago solutions are also available as standard offering. The electrical system features 8 wires and 4 circuits that can be configured in a 2+2 or 3+1 circuit configuration. All electrical components, with the exception of the power feed (which must be connected to the building power supply by a licensed electrician) may be installed by furniture installers, unless otherwise stated by jurisdiction of the installation.

Inscape Bench electrical components consist of the following: Floor/Wall power in-feed, power tracks, jumper cables and duplex receptacles. Power components snap into place without the need of tools and are the same components as offered in Inscape System.

#### POWER IN-FEED

Power In-Feed connections can be made through a wall, column, or floor connection. Power in-feed connections for Full Height applications consist of an 84" long liquid tight cable and a 45" flex cable connected by a 3" metal coupler and elbow joint to sit between bottom rails. Power in-feed connections for Partial Height applications consist of an 84" long liquid tight cable and a 12" flex cable connected by a 3" metal coupler and elbow joint to sit between bottom rails. The liquid tight portion of the Power in-feed must be connected to the building power supply by an electrician. If two power feeds are being specified for one cluster of stations, care must be taken not to cross connect the two feeds through jumper cables and power tracks.

Two versions of the power in-feed exist. One version is to be used with the Full Height Spine and the other is to be used with the Partial height or Storage Spine and includes a wire casing.

#### NEW YORK CITY IN-FEED

New York City has requirements for special power entry assemblies. A qualified electrician is required to hard-wire the New York City In-Feed from the entry box to the power source. The New York City feed works for side feed, end feed or ceiling feed.

#### CITY OF CHICAGO HOLD DOWN BRACKET

The City of Chicago does not permit the use of pre-wired modular electrical systems. To simplify hardwiring of the Inscape Bench Spine, the City of Chicago Hold Down Bracket (INECHB) is available. Specify two INECHB for each power entry point, one for the power feed and one for the outlet. (The outlet box is NOT supplied by Inscape). INECHB's are available in packages of 6.

Boxes should be sourced through Ental Industries or J&A Sheet both local Chicago suppliers of electrical junction boxes.

**NOTE: Spines 30" W will accept one double-sided outlet box. Spines 36" W and wider will accept two boxes. INECHB's may also be specified to mount multi-user termination boxes inside the panel.**

#### POWER POLE

The Bench power pole brings power and data into the station from the ceiling. It includes a split top trim to facilitate cable entry into the spine panel, a ceiling grommet, an optional 16' or 22' long electrical cable and an expandable power pole featuring a septum to separate power from data cables to avoid electromagnetic interference (EMI). Specify ceiling power pole according to panel width as well as an optional selection for A Leg applications, which includes a bottom cover that conceals cables running from the bottom of the channel up to the frame. An electrician must connect the ceiling power entry cable to the building power supply. If two power feeds are specified for one cluster of stations, care must be taken not to cross connect the two feeds through jumper cables and power tracks. The entire power pole accommodates 61 Cat6 and 78 Cat5 cables at a 60% fill capacity if no electrical cable is routed through pole. If electrical is routed within power pole, at a 60% fill capacity, 46 Cat6 and 59 Cat5 cables may be accommodated

2 + 2 CIRCUIT CONFIGURATION

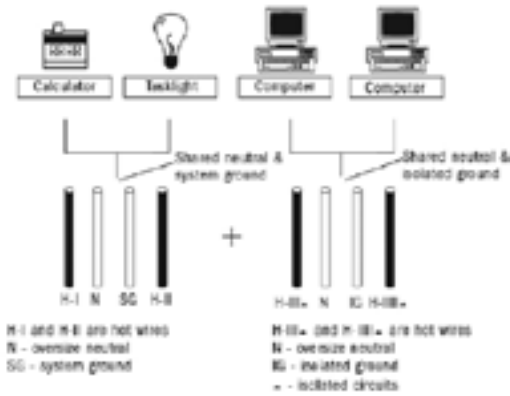

2+2

- Circuits #1 and #2 share one oversized neutral and one shared ground to provide convenience power for task lights, calculators, radios etc.
- Circuits #3 and #4 share the other oversized neutral and isolated ground to provide isolated power to computers.

3+ 1 CIRCUIT CONFIGURATION

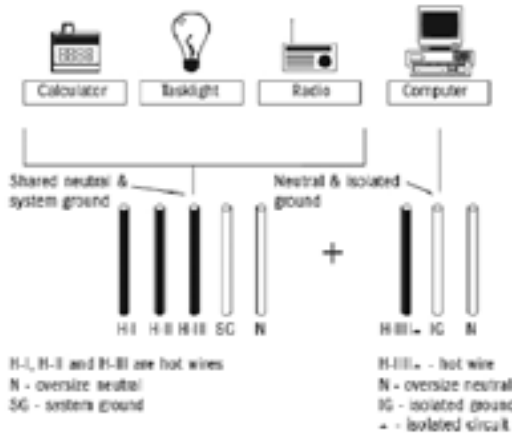

- Circuits #1, #2 and #3 share one oversized neutral and one shared ground to provide convenience power for task lights, calculators, radios etc.
- Circuit #4 uses the other oversized neutral and isolated ground to provide isolated power to computers.

POWER TRACK KITS

Power Track Kits consist of a power track and clips to attach the power track to a crossrail. The kit allows for power tracks to be mounted in specified locations (above or below the worksurface). Jumper cables and receptacles are specified separately. The 30" W Power Track Kit accepts one duplex per side. Power Track Kits which are 36" W and wider accept two duplexes per side. Power Track Kits may be specified below the following; Transaction Tops, Up mount Bins, Stack on Glaze, Add on Glaze and Double Glazed Tiles. Power Track Kits MAY NOT be specified below Twin Bins or Power Poles.

JUMPER CABLES

Jumper Cables by-pass non-powered spines and also facilitates connections from power track to power track. Jumper cables must attach to power tracks only and cannot be attached to adjacent jumper cables or power in-feeds. Product codes indicate the width of the jumper cable which may be cross-referenced in the Inscape Bench Application Guide. Various widths of jumper cables are available to facilitate various applications and configurations. See Inscape Bench Application Guide for details.

DUPLEX RECEPTACLES

Duplex Receptacles snap into power tracks back-to-back and may be accessed through cutouts in either the electrical cover plate with standard frames or multi-access and communication tiles in all other locations and basic frames. Duplexes are interchangeable amongst the varying power track locations. Specify duplexes according to circuit configuration, 2+2 or 3+1. The IN2D3- duplex is specific to 2+2 wire configurations and the IN2DU3- duplex is specified for 3+1 wire configurations. General rule is no more than 12 receptacles per circuit per power in feed. Duplexes may be specified in black, white (close match to P168 – Glacier White) and gray (close match to P290 – Aluminum Leaf).

Controlled receptacles to satisfy California Title 24 are available. These receptacles control circuits through building switches. When circuits are controlled through building switches, it is required to identify which circuit is controlled to the end user. To identify the receptacles on the controlled circuit, Inscape's controlled receptacles have a power mark (circle with the vertical line). The fit and function of these receptacles are same as the standard receptacle offering only application is in controlled circuits.

## DATA COMPONENTS

### HINGED COVER (INHRC)

The hinged cover (INHRC) snaps into the cutouts which are found in multi access and communication tiles. When data faceplates and receptacles are not required the hinged cover provides a visual and protective cover.

### FIBER OPTIC OUTLET

Fiber optic outlet (INCFO) is specified to be installed in a cutout in a multi access or communication tile. May be specified in black, white (close match to P168 – Glacier White) and gray (close match to P290 – Aluminum Leaf).

### DATA AND COMMUNICATION FACEPLATE

The **Data and Communication Faceplate (INCDP)** installs in a cutout in a multi access or communication tile where plug and play access is required. The faceplate provides three “slots” where the **Category 5 (INCABRJ45)**, **Category 6 (INCABR6J45)**, and/or **Telephone Jacks (INCRJ11)** may be inserted. All “openings” need to be filled with data or phone jacks, the **Blank Data Plate Insert (INCB)** fills in any which are not being used. Data components may be specified in black, white (close match to P168 – Glacier White) and gray (close match to P290 – Aluminum Leaf). Telephone Jacks (INCRJ11) are not available in gray. Data Communication Plates (INCDP) are not currently available in white.

### CLAMP ON POWER MODULES

Clamp-on power may be clamped along edge of worksurface for plug and play access to electrical/voice/data. Power Modules plug into the duplexes and attach to 1” and 1 ¼” thick worksurfaces.

The Clamp-On Power Module has a 3 receptacle/1 dual USB port configuration and is available in a black or white finish. It has a 96” long power cord and LED surge protection indication. The mount includes a device holder.

The Clamp-On Power Module with Colored Components comes in many different configurations with receptacles, USB (1 type A and 1 type B) ports and availability lights. Power Modules come in black, white or gray and have colored options for the lid; Black, White, Teal, Red, Purple, Blue, Green, Gray. The availability light is user controlled and requires free software download.

### CABLE HOOKS

Cable Hooks support and segregate data cables. Each frame 37” and higher ships with one cable manager. Cable hooks carry data cables to their termination voice/data point at a multi access or communication tile for plug and play access or to hanger brackets which are located behind the tile.



### WIRE MANAGEMENT CLIPS

Wire Management Clips are required when power is being routed from a Credenza Storage benching application frame to the worksurface. Where cabling is running from behind a Credenza Storage case, these wire management clips are mounted to the underside of the inside of the case and the wires are cleanly routed to the main surface. These clips come in a package of 10 and are white in color.

### WIRE CASING

Wire casing manages cables and technology from a worksurface to the floor. Casing is 29” long but can be adjustable in length by removing or adding “links”. Casing is available in gray. As standard the wire casing accommodates 28.5” H worksurface heights. The wire casing accommodates 30 Cat5 cables with electrical works at a 60% fill capacity which is recommended. Approximately 36 Cat5 cables may be accommodated in the wire casing at a 60% fill capacity without electrical works.

- Partial Height In Feed Kit is slightly shorter than the Full Height Kit and includes wire management casing
- All electrical components are standard 8 wire configuration
- New York City Power In-Feed Kit is for use with a full height spine. To use it with Partial Height or Storage spine application, a wire management casing (INBFWC) needs to be specified
- The power pole is expandable and comes standard with a 16" whip. It also has the option of no power or can accommodate a 22" whip



		Part number	List price
	Standard Floor/Wall Power In Feed Kits	<b>INEFWK-8</b> (use with full spine)	\$361
		<b>INBFWK-8</b> (use with partial height spine)	\$641
	New York City Power In Feed Kit	<b>INEFWK-NY-8</b>	\$641
	Wire Management Casing Gray	<b>INBFWC</b>	\$130

	Part number	Neutral paint/ base price	Optional 22" whip	No power option	Accent paint	
	Power Pole	<b>INBPWRPOLE-8</b>	\$1595	+\$225	-\$238	+\$166

- All electrical components are standard 8 wire configuration
- See Inscape System Application Guide for jumper cable length requirements for varying panel configurations
- Jumper Cables do not connect together nor do they attach to power in feeds

**NOTES**

- Power tracks are required to match the width of the frame they are being installed in
- Power Track Kits may be specified below the following; Transaction Tops, Up mount Bins, Stack on Glaze, Add on Glaze and Double Glazed Tiles
- Power Track Kits MAY NOT be specified below Twin Bins or Power Poles

		Part number	W	List price
	Power Track Kit	<b>INRUDKIT-30-8</b>	30"	\$185
		<b>INRUDKIT-36-8</b>	36"	\$201
		<b>INRUDKIT-42-8</b>	42"	\$219
		<b>INRUDKIT-48-8</b>	48"	\$238
		<b>INRUDKIT-54-8</b>	54"	\$253
		<b>INRUDKIT-60-8</b>	60"	\$273
	Electrified Twin-Bin Power Track	<b>INETPTWB-8</b>	8"	\$88
	Jumper Cables	<b>INETC24-8</b>	24"	\$72
		<b>INETC25-8</b>	25"	\$72
		<b>INETC28-8</b>	28"	\$72
		<b>INETC31-8</b>	31"	\$74
		<b>INETC44-8</b>	44"	\$79
		<b>INETC53-8</b>	53"	\$88
		<b>INETC64-8</b>	64"	\$104
		<b>INETC88-8</b>	88"	\$135
		<b>INETC104-8</b>	104"	\$156
		<b>INETC122-8</b>	122"	\$192
		<b>INETC141-8</b>	141"	\$194
<b>INETC158-8</b>	158"	\$212		
<b>INETC182-8</b>	182"	\$243		



- All electrical components are standard 8 wire configuration
- Circuit 3 receptacle requires 2+2 or 3+1 wire designation (“U” in the code signifies 3+1 wire configuration)
- White is a close match to 168 Glacier White, Gray is a close match to 290 Aluminum Leaf
- The “UD” duplexes are to be specified in conjunction with the Electrified Twin Bin (Inscape System Price List)
- Controlled receptacles satisfy California Title 24 and are indicated with a “power mark” which is represented by a circle with a line

**NOTES**

In order to get a total cost on products when upcharges are present take the list price of the product number and add the upcharge cost shown to the list price.

For example:

Product IN2D1-8 in Gray would be +\$27 +\$11

	Part number	Black/ base price	White	Gray	
	Receptacle for cutout tiles application in 2 3/4" frames	<b>IN2D1-8</b>	\$27	+\$11	+\$11
		<b>IN2D2-8</b>	\$27	+\$11	+\$11
		<b>IN2D3-8</b>	\$27	+\$11	+\$11
		<b>IN2D3U-8</b>	\$27	+\$11	+\$11
		<b>IN2D4-8</b>	\$27	+\$11	+\$11
	Controlled Receptacle for cutout tiles application in 2 3/4" frames	<b>IN2D1-8C</b>	\$32	+\$11	+\$11
		<b>IN2D2-8C</b>	\$32	+\$11	+\$11
		<b>IN2D3-8C</b>	\$32	+\$11	+\$11
		<b>IN2D3U-8C</b>	\$32	+\$11	+\$11
		<b>IN2D4-8C</b>	\$32	+\$11	+\$11
	Receptacle for use in Electrified Twin-Bin	<b>IN3D1-UD-8</b>	\$27	+\$11	+\$11
		<b>IN3D2-UD-8</b>	\$27	+\$11	+\$11
		<b>IN3D3-UD-8</b>	\$27	+\$11	+\$11
		<b>IN3D3U-UD-8</b>	\$27	+\$11	+\$11
		<b>IN3D4-UD-8</b>	\$27	+\$11	+\$11

- The Hinged Cover is a plastic cover that acts as a hinged door to allow access to the cables if needed. Available in color options of black (default), white and gray
- Data cannot be installed directly back to back in a benching spine

**NOTES**







In order to get a total cost on products when upcharges are present take the list price of the product number and add the upcharge cost shown to the list price.

For example:

Product INHRC in Gray would be \$22 +\$11





	Part number	Black/ base price	White	Gray
	<b>INHRC</b>	\$22	+\$11	+\$11

- Wire Management clips are white and attach by double sided tape which is included
- Wire Casing (INFWC) is 29" long and allows for electrical and data cables to be brought neatly from floor into a table – available in gray only, works with 28.5" worksurface heights
- Cable Management Tray (INCMTXX) is available in two lengths, painted Eco Black and includes mounting hardware
- Height Adjustable Cable Manager (INHACMT18) comes with a basic tray (see INCMT18) and 1" Diameter grey plastic wire sleeve that is single length piece with opening slit to accept cables
- 18"w Cable Manager Tray (INHACHCMT18) includes a black rectangular cable chain with an non-hinged tray
- Hinged Cable Manager Tray (INHACMTHINGE) includes black rectangular cable chain with a hinged tray

		Part number	Neutral paint/ base price	Accent paint
	Wire Management Clip (pkg of 10)	<b>INWMCLIP</b>	\$30	—
	Wire Casing (Gray color)	<b>INFWC</b>	\$130	—
	Cable Management Tray	<b>INCMT18</b> <b>INCMT30</b>	\$36 \$47	— —
	Wire mesh cable tray (silver)	<b>INWMTRAY</b>	\$133	—
	Height Adjustable Cable Manager	<b>INHACMT18</b>	\$89	—
	18"w Cable Manager Tray For use with Electric Freestanding and Bench (illustrated) height adjustable applications	<b>INHACHCMT18</b>	\$256	+\$27
	Hinged Cable Manager Tray For use with Electric Freestanding and Bench (illustrated) height adjustable applications	<b>INHACMTHINGE</b>	\$532	+\$56



- Power Modules mount to the back edge of a surface and are accessible by the user above the surface
- Power Modules plug into the duplexes
- The Clamp-On Power Module is available in a black or white finish. It has a 96" long power cord and LED surge protection indication. It attaches to 1" and 1 ¼" thick worksurfaces and the mount includes a device holder.
- The Clamp-On Power Module with Colored Components comes in many different configurations with receptacles, USB (1 type A and 1 type B) ports and availability lights. Power Modules come in black, white or gray and have colored options for the lid; Black, White, Teal, Red, Purple, Blue, Green, Gray. The availability light is user controlled and requires free software download.

	Part number	List price
 <p>Clamp-On Power Module 3 receptacles/1 dual USB port</p>	<b>INPMOD-3P1U</b>	\$173
 <p>Clamp-On Power Module with Colored Components 2 Ports: 1 receptacle + 1 USB AC</p>	<b>INBPMOD-1P1U</b>	\$437
 <p>Clamp-On Power Module with Colored Components 4 Ports: 2 receptacles + 1 USB AC + 1 open data port data not provided</p>	<b>INBPMOD-2P1U1O</b>	\$548
 <p>Clamp-On Power Module with Colored Components 4 Ports: 2 receptacles + 1 USB AC + 1 availability light</p>	<b>INBPMOD-2P1U1L</b>	\$867

**Bench**  
Worksurfaces  
& Supports

**inscape**

work for tomorrow

Depth dimension is nominal. Depths are .325" less than stated to provide a gap between the worksurface and panel to facilitate wire management. Worksurfaces are specific to the worksurface support they are being installed on. Codes and dimensions are outlined in the following pages and Inscape Bench Application Guide showing which worksurface is to be specified with the End Gable, Open "H" Leg or Storage Support.

Depth dimensions listed on Height Adjustable surfaces are actual.

All worksurfaces default to 1.25" thick, Straight edge, Pencil Groove.

Grain direction on woodgrain Nuform worksurfaces is as denoted below.

**NUFORM CLASSIC & NUFORM SELECT WORKSURFACES**

The Nuform top is a thermo-formable polymer based sheet continuously bonded to a 1.25" thick MDF substrate. The polymer sheet is surface coated with a scratch resistant film. Colors are homogenous throughout the film thickness. Top and edge are one continuous surface with no edge seams. The underside of the top is finished in a low pressure melamine. Nuform tops have the option of a pencil groove running across the width of the worksurface as standard and depth for conference tables. Two price options are available - Nuform Classic and Nuform Select.

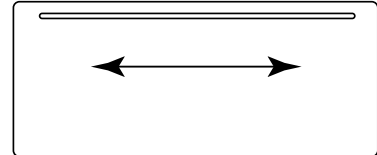

**WORKSURFACE EXTENSION**

The Worksurface Extension is a cantilevered worksurface which is situated perpendicular to the spine. This top is available in all the worksurface finishes of the standard worksurfaces (if woodgrain is chosen, pattern will run perpendicular to the main worksurfaces). This extension CANNOT be specified adjacent to the Height Adjustable Worksurfaces.

**Edge Detail - Nuform Solid and Nuform Woodgrain**

1 1/4" Straight Edge



1 1/4" Tapered Edge



Top and edge are one continuous surface with no edge seams.

Note that the tapered edge style is only available on the front or user edge of the worksurface.

**LAMINATE WORKSURFACES**

Plastic laminate is laminated to 1.25" thick particle-board. The underside of the worksurface is finished with a man-made, wood-fiber veneer backer. Worksurfaces specified with a plastic laminate finish include a 2mm edge banding in a coordinating color. Plastic laminate tops do not include a pencil groove.

**Edge Detail - Plastic Laminate**

Straight Edge



**Load capacity for freestanding and panel mounted worksurfaces is 4.5lbs per linear inch.**

## ADJUSTABLE HEIGHT WORKSURFACES

Panel Mounted Electrical height adjustable worksurfaces are available for the Inscape Bench.

Electrical Height Adjustable Worksurfaces provide height adjustment ranging from 28.5" to 44.5" with a lift capacity and calibration of a recommended 195lbs (includes worksurface).

Worksurfaces structured on the height adjustable mechanism are 1" less in stated width in the price list, and are meant to be installed on center to the base allowing for a gap between adjacent surfaces to eliminate pinch points. The base mechanism of the worksurface is available in Silver only. See the Inscape Bench Application Guide for application notes and restrictions.

## WORKSURFACE SUPPORT BRACKETS & ACCESSORIES

### CANTILEVER BRACKET

Cantilever Bracket is fixed. Cantilever brackets support panel mounted worksurfaces on-module.

### FLUSH BRACKETS

Flush Brackets are specified when two adjoining worksurfaces need to be held flush together. These brackets (INFB) come as a pair. Maximum span of overhang when supported with a flush bracket is 18" per side. These are not required for Height Adjustable worksurfaces.

### SPACERS

Spacers are specified when storage is being specified within the bench. The appropriate height of storage to use within the bench is 22.5" id with FLAT GLIDE (Rectangular glides will not line up below the worksurface)

### LEG ANCHOR BRACKET

A Bench 30"d Single Sided Electric Height Adjustable table must have rear glides at every height adjustable support bracket anchored to a concrete floor using the Leg Anchor Bracket and customer supplied 3/8"-16 x 2.25" (min.) concrete anchor studs. See installation manual for further details.

### PEDESTAL BRACKETS

Pedestal Brackets are specified when a pedestal unit is being specified. This allows for docking of the storage pieces to the benching spine. End Location Bracket is to be specified when the pedestal is at the end of a run. The Middle Location Bracket is to be specified when a pedestal is situated below the bench within the bench.

*\*See Inscape Bench Application Guide.*

## STORAGE DOCKING BRACKET

Storage Docking Bracket is used when lateral or bookcase units are specified perpendicular to the spine. This bracket docks the storage and worksurface to the spine.

*\*See Inscape Bench Application Guide.*

## 90° WORKSURFACE SUPPORT BRACKETS

90° worksurface to spine support brackets support a 90° worksurface off of a spine frame. These brackets are handed left or right and there is a double sided option. The handedness of the support bracket is from the user perspective. Brackets are available in all standard paint finishes.

## SHARED WORKSURFACE SUPPORT BRACKETS

Shared worksurface support brackets are used to support either a 30"d or 36"d shared worksurface off of a spine frame(s) and are available in on module and mid module applications. See Inscape Bench Application Guide for application guidelines. Brackets are available in all standard paint finishes

## ANGLED WOOD SUPPORT LEG

The angled wood fixed worksurface support leg supports the end of a 90° or shared worksurface that is not bracketed to the spine frames. The angled wood fixed worksurface support leg come in three finish options; Clear Oak (default), Black Oak and Clear Maple.

## LATERAL TOPS

The Lateral Tops are available as 3/4" thick. These tops are to be specified atop the 22.5" id storage units, FLAT GLIDE only on storage. Tops are available in all standard Nuform finishes.

## END SUPPORT

There are three main ways to support the Inscape Bench from an end support perspective. One option is a Full End Gable. This end gable unit spans the entire depth of the bench beneath the worksurfaces, which are specific to this support type. The End Gable is a fully kitted product code which includes trim, tiles, glides and structure. The trim can be painted in any standard paint color. Tiles are to be specified on the inside and outside of the end gable. Tiles on the interior consist of two separate tiles whereas the outside is one full tile. Woodgrain on the exterior tile will run vertical on the tile. The Full End Gable is only to be used with the Full Height Spine.

An alternative support is the Open End Leg which is available in the "H", "O" and "A" options. This open leg structure has the ability to span the entire depth of the bench as well as carry multiple storage/accessories components. These units may be found in the Accessories section and are specific to the Open End Leg. The Open End Leg is only to be used with the Partial Height Spine; unless the Height Adjustable version is being used.

Open O legs have the option to add a glazed insert to either the double or single sided applications. The inserts are glass and are available in clear, gray and etched 1 side finish options.

H Leg hole covers are available for use with H Legs that have been optioned for electric height adjustable worksurfaces as holes are visible. These covers are a small flat rectangular powder coated (any color) sheet steel part that has double sided tape attached and will ship 4 per pack.

Both support types have a mid-span support which matches the overall end aesthetic. These are available in 12", 18" and 24" d. Tiles on the Full Gable version are painted only.

When the Height Adjustable Worksurface is specified, either the Full End Gable or the Open End Leg which is specific to the Height Adjustable may be specified. See Inscape Bench Application Guide for more details.

## SINGLE SIDED BENCH

Single Sided Bench may be specified to create single sided bench configuration. This application may only be used with a full height spine only. End Gable or Open End Legs are end support options. The legs include supports to tie into the spine or worksurface. Mid Supports, whether Full Gable or Open End Legs must be specified between two worksurfaces and tie into the spine on module. Use 18" mid support for 24" d worksurface and 24" mid support for 30" d worksurface. Benching worksurfaces are to be specified in the same way for single sided version of the bench. 36" d worksurfaces are not available in single sided version. When tiling full height tiles are to be specified. Nuform and laminate tiles cannot be used on single sided frames with electrical. When integrating height adjustable in a single sided application, specific end supports must be specified. The Single Sided Frame to Worksurface bracket must be specified to tie the worksurface into the spine.

## Worksurfaces & Supports

Rectangular Tops  
Middle Application

# Bench



- Depth dimension is nominal. Depths are .325" less than stated to provide a gap between the worksurface and panel to facilitate wire management.
- Worksurfaces are to be specified with any Inscape Bench spine in a middle or non-end position
- Nuform and Laminate
- Straight & Tapered edge available on Nuform
- 84" and 96" worksurfaces require same support as two surfaces
- Stretcher bars are required to be specified with worksurfaces 54" and wider which do have any mid support
- Stretcher bars are also required for all 30" or deeper worksurfaces no matter the width including when mid cantilever is installed
- Be sure stretcher bars do not to interfere with support brackets, cable trays or other work tools

### NOTES

In order to get a total cost on products when upcharges are present take the list price of the product number and add the upcharge cost shown to the list price.

For example:

Product INBW2442 in Nuform Select with Tapered Edge would be \$377 +\$42 +\$21

	Part number	W	D	Nuform classic/ laminate/ base price	Nuform select	Nuform tapered	Grade 1 laminate	Grade 2 laminate
 <p>24" D Rectangular Top Middle Application</p>	<b>INBW2442</b>	42"	24"	\$377	+\$42	+\$21	+\$123	+\$356
	<b>INBW2448</b>	48"	24"	\$432	+\$47	+\$23	+\$140	+\$362
	<b>INBW2454</b>	54"	24"	\$485	+\$53	+\$29	+\$158	+\$368
	<b>INBW2460</b>	60"	24"	\$538	+\$57	+\$31	+\$173	+\$382
	<b>INBW2472</b>	72"	24"	\$646	+\$67	+\$34	+\$209	+\$385
	<b>INBW2484</b>	84"	24"	\$755	+\$79	+\$37	+\$243	+\$394
	<b>INBW2496</b>	96"	24"	\$867	+\$90	+\$46	+\$279	+\$399
 <p>30" D Rectangular Top Middle Application</p>	<b>INBW3042</b>	42"	30"	\$472	+\$51	+\$27	+\$153	+\$404
	<b>INBW3048</b>	48"	30"	\$538	+\$57	+\$31	+\$173	+\$408
	<b>INBW3054</b>	54"	30"	\$604	+\$63	+\$32	+\$196	+\$413
	<b>INBW3060</b>	60"	30"	\$674	+\$70	+\$35	+\$216	+\$416
	<b>INBW3072</b>	72"	30"	\$807	+\$85	+\$42	+\$259	+\$426
	<b>INBW3084</b>	84"	30"	\$980	+\$102	+\$52	+\$316	+\$398
	<b>INBW3096</b>	96"	30"	\$1156	+\$120	+\$60	+\$371	+\$378

## Worksurfaces & Supports

Rectangular Tops  
Full End Gable Application

# Bench



- Depth dimension is nominal. Depths are .325" less than stated to provide a gap between the worksurface and panel to facilitate wire management.
- Worksurfaces are to be specified with End Gable end support
- Nuform and Laminate
- Straight & Tapered edge available on Nuform
- 84" and 96" worksurfaces require same support as two surfaces
- Stretcher bars are required to be specified with worksurfaces 54" and wider which do have any mid support
- Stretcher bars are also required for all 30" or deeper worksurfaces no matter the width including when mid cantilever is installed
- Be sure stretcher bars do not to interfere with support brackets, cable trays or other work tools

### NOTES

In order to get a total cost on products when upcharges are present take the list price of the product number and add the upcharge cost shown to the list price.

For example:

Product INBWE2442 in Nuform Select with Tapered Edge would be \$395 +\$44 +\$22

	Part number	W	D	Nuform classic/ laminite/ base price	Nuform select	Nuform tapered	Grade 1 laminite	Grade 2 laminite
 24" D Rectangular Top Full End Gable Application	<b>INBWE2442</b>	44.75"	24"	\$395	+\$44	+\$22	+\$128	+\$373
	<b>INBWE2448</b>	50.75"	24"	\$452	+\$50	+\$25	+\$145	+\$380
	<b>INBWE2454</b>	56.75"	24"	\$509	+\$56	+\$30	+\$165	+\$386
	<b>INBWE2460</b>	62.75"	24"	\$565	+\$59	+\$32	+\$182	+\$401
	<b>INBWE2472</b>	74.75"	24"	\$680	+\$71	+\$35	+\$219	+\$403
	<b>INBWE2484</b>	86.75"	24"	\$794	+\$85	+\$39	+\$255	+\$413
	<b>INBWE2496</b>	98.75"	24"	\$910	+\$93	+\$48	+\$292	+\$420
 30" D Rectangular Top Full End Gable Application	<b>INBWE3042</b>	44.75"	30"	\$495	+\$53	+\$29	+\$160	+\$426
	<b>INBWE3048</b>	50.75"	30"	\$565	+\$59	+\$32	+\$182	+\$429
	<b>INBWE3054</b>	56.75"	30"	\$634	+\$66	+\$33	+\$205	+\$435
	<b>INBWE3060</b>	62.75"	30"	\$708	+\$73	+\$36	+\$228	+\$437
	<b>INBWE3072</b>	74.75"	30"	\$847	+\$88	+\$44	+\$274	+\$445
	<b>INBWE3084</b>	86.75"	30"	\$1030	+\$106	+\$54	+\$331	+\$417
	<b>INBWE3096</b>	98.75"	30"	\$1211	+\$127	+\$63	+\$389	+\$398

## Worksurfaces & Supports

Rectangular Tops  
Open End Leg Application

# Bench



- Depth dimension is nominal. Depths are .325" less than stated to provide a gap between the worksurface and panel to facilitate wire management. Worksurfaces are to be specified with Open End Leg end support
- Nuform and Laminate
- Straight & Tapered edge available on Nuform
- 84" and 96" worksurfaces require same support as two surfaces
- Stretcher bars are required to be specified with worksurfaces 54" and wider which do have any mid support
- Stretcher bars are also required for all 30" or deeper worksurfaces no matter the width including when mid cantilever is installed
- Be sure stretcher bars do not to interfere with support brackets, cable trays or other work tools

### NOTES

In order to get a total cost on products when upcharges are present take the list price of the product number and add the upcharge cost shown to the list price.

For example:

Product INBWO2442 in Nuform Select with Tapered Edge would be \$395 +\$44 +\$22

	Part number	W	D	Nuform classic/ laminate/ base price	Nuform select	Nuform tapered	Grade 1 laminate	Grade 2 laminate
 <p>24" D Rectangular Top Open End Leg Application</p>	<b>INBWO2442</b>	44.036"	24"	\$395	+\$44	+\$22	+\$128	+\$373
	<b>INBWO2448</b>	50.036"	24"	\$452	+\$50	+\$25	+\$145	+\$380
	<b>INBWO2454</b>	56.036"	24"	\$509	+\$56	+\$30	+\$165	+\$386
	<b>INBWO2460</b>	62.036"	24"	\$565	+\$59	+\$32	+\$182	+\$401
	<b>INBWO2472</b>	74.036"	24"	\$680	+\$71	+\$35	+\$219	+\$403
	<b>INBWO2484</b>	86.036"	24"	\$794	+\$85	+\$39	+\$255	+\$413
	<b>INBWO2496</b>	98.036"	24"	\$910	+\$93	+\$48	+\$292	+\$420
 <p>30" D Rectangular Top Open End Leg Application</p>	<b>INBWO3042</b>	44.036"	30"	\$495	+\$53	+\$29	+\$160	+\$426
	<b>INBWO3048</b>	50.036"	30"	\$565	+\$59	+\$32	+\$182	+\$429
	<b>INBWO3054</b>	56.036"	30"	\$634	+\$66	+\$33	+\$205	+\$435
	<b>INBWO3060</b>	62.036"	30"	\$708	+\$73	+\$36	+\$228	+\$437
	<b>INBWO3072</b>	74.036"	30"	\$847	+\$88	+\$44	+\$274	+\$445
	<b>INBWO3084</b>	86.036"	30"	\$1030	+\$106	+\$54	+\$331	+\$417
	<b>INBWO3096</b>	98.036"	30"	\$1211	+\$127	+\$63	+\$389	+\$398



## Worksurfaces & Supports

Rectangular Tops  
End Storage Application

# Bench



- Depth dimension is nominal. Depths are .325" less than stated to provide a gap between the worksurface and panel to facilitate wire management.
- Worksurfaces are to be specified when storage is being used as end support
- Nuform and Laminate
- Straight & Tapered edge available on Nuform
- 84" and 96" worksurfaces require same support as two surfaces
- Stretcher bars are required to be specified with worksurfaces 54" and wider which do have any mid support
- Stretcher bars are also required for all 30" or deeper worksurfaces no matter the width including when mid cantilever is installed
- Be sure stretcher bars do not to interfere with support brackets, cable trays or other work tools

### NOTES

In order to get a total cost on products when upcharges are present take the list price of the product number and add the upcharge cost shown to the list price.

For example:

Product INBWF2442 in Nuform Select with Tapered Edge would be \$395 +\$44 +\$22

	Part number	W	D	Nuform classic/ laminate/ base price	Nuform select	Nuform tapered	Grade 1 laminate	Grade 2 laminate
 <p>24" D Rectangular Top End Storage Application</p>	<b>INBWF2442</b>	42.3"	24"	\$395	+\$44	+\$22	+\$128	+\$373
	<b>INBWF2448</b>	48.3"	24"	\$452	+\$50	+\$25	+\$145	+\$380
	<b>INBWF2454</b>	54.3"	24"	\$509	+\$56	+\$30	+\$165	+\$386
	<b>INBWF2460</b>	60.3"	24"	\$565	+\$59	+\$32	+\$182	+\$401
	<b>INBWF2472</b>	72.3"	24"	\$680	+\$71	+\$35	+\$219	+\$403
	<b>INBWF2484</b>	84.3"	24"	\$794	+\$85	+\$39	+\$255	+\$413
	<b>INBWF2496</b>	96.3"	24"	\$910	+\$93	+\$48	+\$292	+\$420
	 <p>30" D Rectangular Top End Storage Application</p>	<b>INBWF3042</b>	42.3"	30"	\$495	+\$53	+\$29	+\$160
<b>INBWF3048</b>		48.3"	30"	\$565	+\$59	+\$32	+\$182	+\$429
<b>INBWF3054</b>		54.3"	30"	\$634	+\$66	+\$33	+\$205	+\$435
<b>INBWF3060</b>		60.3"	30"	\$708	+\$73	+\$36	+\$228	+\$437
<b>INBWF3072</b>		72.3"	30"	\$847	+\$88	+\$44	+\$274	+\$445
<b>INBWF3084</b>		84.3"	30"	\$1030	+\$106	+\$54	+\$331	+\$417
<b>INBWF3096</b>		96.3"	30"	\$1211	+\$127	+\$63	+\$389	+\$398



- Rectangular Curved worksurfaces have curved back corners and straight 90° front corners
- Stretcher bars are included with all perpendicular worksurfaces
- The curved rectangular perpendicular worksurface will overhang 4.5" from the spine end line
- The straight rectangular perpendicular worksurfaces will overhang .300" from the spine end line which will bring it flush with the end trim
- The shared worksurface is not available with a tapered edge and freestanding end support legs must be specified separately

**NOTES**

In order to get a total cost on products when upcharges are present take the list price of the product number and add the upcharge cost shown to the list price.

For example:

Product INBWCP2448 in Nuform Select with Tapered Edge would be \$432 +\$47 +\$23

	Part number	W	D	Nuform classic/ laminate/ base price	Nuform select	Nuform tapered	Grade 1 laminate	Grade 2 laminate
	<b>INBWCP2448</b>	48"	24"	\$432	+\$47	+\$23	+\$139	+\$356
	<b>INBWCP2454</b>	54"	24"	\$485	+\$53	+\$29	+\$161	+\$368
	<b>INBWCP2460</b>	60"	24"	\$538	+\$57	+\$31	+\$172	+\$382
Curved Rectangular 90° Worksurface with back curved corners	<b>INBWCP3048</b>	48"	30"	\$538	+\$57	+\$31	+\$172	+\$408
	<b>INBWCP3054</b>	54"	30"	\$604	+\$63	+\$32	+\$194	+\$413
	<b>INBWCP3060</b>	60"	30"	\$674	+\$70	+\$35	+\$214	+\$416
	<b>INBWSP2448</b>	48"	24"	\$432	+\$47	+\$23	+\$139	+\$362
	<b>INBWSP2454</b>	54"	24"	\$485	+\$53	+\$29	+\$161	+\$368
	<b>INBWSP2460</b>	60"	24"	\$538	+\$57	+\$31	+\$172	+\$382
Straight Rectangular 90° Worksurface	<b>INBWSP3048</b>	48"	30"	\$538	+\$57	+\$31	+\$172	+\$408
	<b>INBWSP3054</b>	54"	30"	\$604	+\$63	+\$32	+\$194	+\$413
	<b>INBWSP3060</b>	60"	30"	\$674	+\$70	+\$35	+\$214	+\$416
	<b>INBWSHSP3048</b>	48"	30"	\$538	+\$57	—	+\$172	+\$408
	<b>INBWSHSP3054</b>	54"	30"	\$604	+\$63	—	+\$194	+\$413
	<b>INBWSHSP3060</b>	60"	30"	\$674	+\$70	—	+\$214	+\$416
Straight Rectangular Shared Worksurface	<b>INBWSHSP3648</b>	48"	36"	\$621	+\$66	—	+\$205	+\$486
	<b>INBWSHSP3654</b>	54"	36"	\$699	+\$73	—	+\$225	+\$492
	<b>INBWSHSP3660</b>	60"	36"	\$783	+\$84	—	+\$251	+\$521

## Worksurfaces & Supports

120° Worksurface  
Middle Application

# Bench

- Depth dimension is nominal. Depths are .325" less than stated to provide a gap between the worksurface and panel to facilitate wire management.
- Worksurfaces are to be specified with any Inscape Bench spine in a middle or non-end position
- 24"d worksurfaces have a front dimension of 38"
- 30"d worksurfaces have a front dimension of 32"
- Specific worksurfaces must be used in specific applications based on location and end support
- Nuform\* and Laminate
- \*All 23"D 120° surfaces that are 54"W & 60"W are NOT available in Nuform
- \*All 29"W 120° surfaces that are 48"W, 54"W & 60"W are NOT available in Nuform
- Straight & Tapered edge available on Nuform
- Stretcher bars are required to be specified with worksurfaces 54" and wider which do have any mid support

- Stretcher bars are also required for all 30" or deeper worksurfaces no matter the width including when mid cantilever is installed
- Be sure stretcher bars do not to interfere with support brackets, cable trays or other work tools

### NOTES

In order to get a total cost on products when upcharges are present take the list price of the product number and add the upcharge cost shown to the list price.

For example:

Product INBWVM363624-S in Grade 1 laminate would be \$539 +\$174

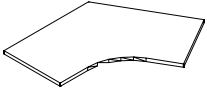
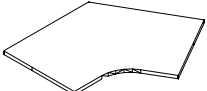
	Part number	W	D	Nuform classic/ laminate/ base price	Nuform select	Nuform tapered	Grade 1 laminate	Grade 2 laminate
 <p>24" D 120° Worksurface Middle Application</p>	<b>INBWVM363624</b>	36"	23"	\$539	+\$54	+\$31	+\$174	+\$605
	<b>INBWVM424224</b>	42"	23"	\$767	+\$79	+\$43	+\$247	+\$680
	<b>INBWVM484824</b>	48"	23"	\$939	+\$97	+\$48	+\$302	+\$801
	<b>INBWVM545424</b>	54"	23"	\$1037	—	—	+\$333	—
	<b>INBWVM606024</b>	60"	23"	\$1306	—	—	+\$420	—
 <p>30" D 120° Worksurface Middle Application</p>	<b>INBWVM363630</b>	36"	29"	\$666	+\$67	+\$34	+\$214	+\$638
	<b>INBWVM424230</b>	42"	29"	\$806	+\$84	+\$43	+\$259	+\$771
	<b>INBWVM484830</b>	48"	29"	\$971	—	—	+\$313	—
	<b>INBWVM545430</b>	54"	29"	\$1134	—	—	+\$364	—
	<b>INBWVM606030</b>	60"	29"	\$1422	—	—	+\$456	—

# Worksurfaces & Supports

120° Worksurface  
Full End Gable Application

- Depth dimension is nominal. Depths are .325" less than stated to provide a gap between the worksurface and panel to facilitate wire management.
- Worksurfaces are to be specified when Full End Gable are used as end support
- 24" D worksurfaces have a front dimension of 38"
- 30" D worksurfaces have a front dimension of 32"
- Specific worksurfaces must be used in specific applications based on location and end support
- Nuform\* and Laminate
- \*All 23"D 120° surfaces that are 54"W & 60"W are NOT available in Nuform
- \*All 29"W 120° surfaces that are 48"W, 54"W & 60"W are NOT available in Nuform
- Straight & Tapered edge available on Nuform
- Stretcher bars are required to be specified with worksurfaces 54" and wider which do have any mid support

- Stretcher bars are also required for all 30" or deeper worksurfaces no matter the width including when mid cantilever is installed
- Be sure stretcher bars do not to interfere with support brackets, cable trays or other work tools

## NOTES

In order to get a total cost on products when upcharges are present take the list price of the product number and add the upcharge cost shown to the list price.

For example:

Product INBWWLHE363624-S in Grade 1 laminate would be \$566 +\$182

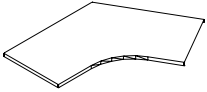
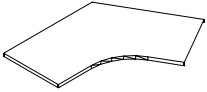
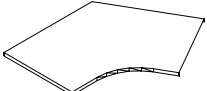
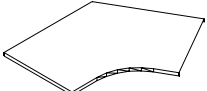
	Part number	W	D	Nuform classic/ laminate/ base price	Nuform select	Nuform tapered	Grade 1 laminate	Grade 2 laminate
 <p>24" D 120° Worksurface Full End Gable Application</p>	<b>INBWWLHE363624</b>	36"	23"	\$566	+\$58	+\$31	+\$182	+\$646
	<b>INBWWLHE424224</b>	42"	23"	\$806	+\$84	+\$43	+\$259	+\$722
	<b>INBWWLHE484824</b>	48"	23"	\$984	+\$99	+\$51	+\$317	+\$843
	<b>INBWWLHE545424</b>	54"	23"	\$1090	—	—	+\$350	—
	<b>INBWWLHE606024</b>	60"	23"	\$1372	—	—	+\$441	—
	left-handed							
 <p>24" D 120° Worksurface Full End Gable Application</p>	<b>INBWWRHE363624</b>	36"	23"	\$566	+\$58	+\$31	+\$182	+\$646
	<b>INBWWRHE424224</b>	42"	23"	\$806	+\$84	+\$43	+\$259	+\$722
	<b>INBWWRHE484824</b>	48"	23"	\$984	+\$99	+\$51	+\$317	+\$843
	<b>INBWWRHE545424</b>	54"	23"	\$1090	—	—	+\$350	—
	<b>INBWWRHE606024</b>	60"	23"	\$1372	—	—	+\$441	—
	right-handed							
 <p>30" D 120° Worksurface Full End Gable Application</p>	<b>INBWWLHE363630</b>	36"	29"	\$698	+\$71	+\$36	+\$225	+\$680
	<b>INBWWLHE424230</b>	42"	29"	\$846	+\$87	+\$45	+\$273	+\$815
	<b>INBWWLHE484830</b>	48"	29"	\$1019	—	—	+\$328	—
	<b>INBWWLHE545430</b>	54"	29"	\$1193	—	—	+\$383	—
	<b>INBWWLHE606030</b>	60"	29"	\$1494	—	—	+\$479	—
	left-handed							
 <p>30" D 120° Worksurface Full End Gable Application</p>	<b>INBWWRHE363630</b>	36"	29"	\$698	+\$71	+\$36	+\$225	+\$680
	<b>INBWWRHE424230</b>	42"	29"	\$846	+\$87	+\$45	+\$273	+\$815
	<b>INBWWRHE484830</b>	48"	29"	\$1019	—	—	+\$328	—
	<b>INBWWRHE545430</b>	54"	29"	\$1193	—	—	+\$383	—
	<b>INBWWRHE606030</b>	60"	29"	\$1494	—	—	+\$479	—
	right-handed							

# Worksurfaces & Supports

120° Worksurface  
Full End Gable Application

- Depth dimension is nominal. Depths are .325" less than stated to provide a gap between the worksurface and panel to facilitate wire management.
- Worksurfaces are to be specified when Full End Gable are used as end support
- 24" D worksurfaces have a front dimension of 38"
- 30" D worksurfaces have a front dimension of 32"
- Specific worksurfaces must be used in specific applications based on location and end support
- Nuform\* and Laminate
- \*All 23"D 120° surfaces that are 54"W & 60"W are NOT available in Nuform
- \*All 29"W 120° surfaces that are 48"W, 54"W & 60"W are NOT available in Nuform
- Straight & Tapered edge available on Nuform
- Stretcher bars are required to be specified with worksurfaces 54" and wider which do have any mid support
- Stretcher bars are also required for all 30" or deeper worksurfaces no matter the width including when mid cantilever is installed
- Be sure stretcher bars do not to interfere with support brackets, cable trays or other work tools

### NOTES

In order to get a total cost on products when upcharges are present take the list price of the product number and add the upcharge cost shown to the list price.

For example:

Product INBWVDE363624-S in Grade 1 laminate would be \$592 +\$192

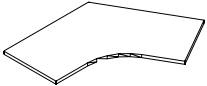

	Part number	W	D	Nuform classic/ laminate/ base price	Nuform select	Nuform tapered	Grade 1 laminate	Grade 2 laminate
24" D 120° Worksurface Double Full End Gable Application	<b>INBWVDE363624</b>	36"	23"	\$592	+\$60	+\$32	+\$192	+\$686
	<b>INBWVDE424224</b>	42"	23"	\$844	+\$87	+\$44	+\$273	+\$762
	<b>INBWVDE484824</b>	48"	23"	\$1032	+\$103	+\$53	+\$331	+\$885
	<b>INBWVDE545424</b>	54"	23"	\$1140	—	—	+\$367	—
	<b>INBWVDE606024</b>	60"	23"	\$1438	—	—	+\$463	—



30" D 120° Worksurface Double Full End Gable Application	<b>INBWVDE363630</b>	36"	29"	\$733	+\$73	+\$37	+\$237	+\$722
	<b>INBWVDE424230</b>	42"	29"	\$886	+\$90	+\$46	+\$286	+\$859
	<b>INBWVDE484830</b>	48"	29"	\$1066	—	—	+\$343	—
	<b>INBWVDE545430</b>	54"	29"	\$1248	—	—	+\$401	—
	<b>INBWVDE606030</b>	60"	29"	\$1565	—	—	+\$503	—

# Worksurfaces & Supports

120° Worksurface  
Open End Leg Application



- Depth dimension is nominal. Depths are .325" less than stated to provide a gap between the worksurface and panel to facilitate wire management.
- Worksurfaces are to be specified when Open End Legs are used as end support
- 24" D worksurfaces have a front dimension of 38"
- 30" D worksurfaces have a front dimension of 32"
- Specific worksurfaces must be used in specific applications based on location and end support
- Nuform\* and Laminate
- \*All 23"D 120° surfaces that are 54"W & 60"W are NOT available in Nuform
- \*All 29"W 120° surfaces that are 48"W, 54"W & 60"W are NOT available in Nuform
- Straight & Tapered edge available on Nuform
- Stretcher bars are required to be specified with worksurfaces 54" and wider which do have any mid support
- Stretcher bars are also required for all 30" or deeper worksurfaces no matter the width including when mid cantilever is installed
- Be sure stretcher bars do not to interfere with support brackets, cable trays or other work tools

### NOTES

In order to get a total cost on products when upcharges are present take the list price of the product number and add the upcharge cost shown to the list price.

For example:

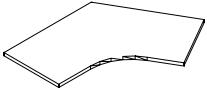
Product INBWWLHO363624-S in Grade 1 laminate would be \$566 +\$182

	Part number	W	D	Nuform classic/ laminate/ base price	Nuform select	Nuform tapered	Grade 1 laminate	Grade 2 laminate
 <p>24" D 120° Worksurface Open End Leg Application</p>	<b>INBWWLHO363624</b>	36"	23"	\$566	+\$58	+\$30	+\$182	+\$646
	<b>INBWWLHO424224</b>	42"	23"	\$806	+\$84	+\$43	+\$259	+\$722
	<b>INBWWLHO484824</b>	48"	23"	\$984	+\$99	+\$51	+\$317	+\$843
	<b>INBWWLHO545424</b>	54"	23"	\$1090	—	—	+\$350	—
	<b>INBWWLHO606024</b>	60"	23"	\$1372	—	—	+\$441	—
	left-handed							
	<b>INBWWRHO363624</b>	36"	23"	\$566	+\$58	+\$31	+\$182	+\$646
	<b>INBWWRHO424224</b>	42"	23"	\$806	+\$84	+\$43	+\$259	+\$722
	<b>INBWWRHO484824</b>	48"	23"	\$984	+\$99	+\$51	+\$317	+\$843
	<b>INBWWRHO545424</b>	54"	23"	\$1090	—	—	+\$350	—
<b>INBWWRHO606024</b>	60"	23"	\$1372	—	—	+\$441	—	
right-handed								
 <p>30" D 120° Worksurface Open End Leg Application</p>	<b>INBWWLHO363630</b>	36"	29"	\$698	+\$71	+\$36	+\$225	+\$680
	<b>INBWWLHO424230</b>	42"	29"	\$846	+\$87	+\$45	+\$273	+\$815
	<b>INBWWLHO484830</b>	48"	29"	\$1019	—	—	+\$328	—
	<b>INBWWLHO545430</b>	54"	29"	\$1193	—	—	+\$383	—
	<b>INBWWLHO606030</b>	60"	29"	\$1494	—	—	+\$479	—
	left-handed							
	<b>INBWWRHO363630</b>	36"	29"	\$698	+\$71	+\$36	+\$225	+\$680
	<b>INBWWRHO424230</b>	42"	29"	\$846	+\$87	+\$45	+\$273	+\$815
	<b>INBWWRHO484830</b>	48"	29"	\$1019	—	—	+\$328	—
	<b>INBWWRHO545430</b>	54"	29"	\$1193	—	—	+\$383	—
<b>INBWWRHO606030</b>	60"	29"	\$1494	—	—	+\$479	—	
right-handed								

## Worksurfaces & Supports

120° Worksurface  
Open End Leg Application

# Bench



- Depth dimension is nominal. Depths are .325" less than stated to provide a gap between the worksurface and panel to facilitate wire management.
- Worksurfaces are to be specified when Open End Legs are used as end support
- 24" D worksurfaces have a front dimension of 38"
- 30" D worksurfaces have a front dimension of 32"
- Specific worksurfaces must be used in specific applications based on location and end support
- Nuform\* and Laminate
- \*All 23"D 120° surfaces that are 54"W & 60"W are NOT available in Nuform
- \*All 29"W 120° surfaces that are 48"W, 54"W & 60"W are NOT available in Nuform
- Straight & Tapered edge available on Nuform
- Stretcher bars are required to be specified with worksurfaces 54" and wider which do have any mid support
- Stretcher bars are also required for all 30" or deeper worksurfaces no matter the width including when mid cantilever is installed
- Be sure stretcher bars do not to interfere with support brackets, cable trays or other work tools

### NOTES

In order to get a total cost on products when upcharges are present take the list price of the product number and add the upcharge cost shown to the list price.

For example:

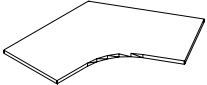
Product INBWV LHO363624-S in Grade 1 laminate would be \$566 +\$182

	Part number	W	D	Nuform classic/ laminate/ base price	Nuform select	Nuform tapered	Grade 1 laminate	Grade 2 laminate
 <p>24" D 120° Worksurface Double Open End Leg Application</p>	<b>INBWVDO363624</b>	36"	23"	\$592	+\$60	+\$32	+\$192	+\$686
	<b>INBWVDO424224</b>	42"	23"	\$844	+\$87	+\$44	+\$273	+\$762
	<b>INBWVDO484824</b>	48"	23"	\$1032	+\$103	+\$53	+\$331	+\$885
	<b>INBWVDO545424</b>	54"	23"	\$1140	—	—	+\$367	—
	<b>INBWVDO606024</b>	60"	23"	\$1438	—	—	+\$463	—
 <p>30" D 120° Worksurface Double Open End Leg Application</p>	<b>INBWVDO363630</b>	36"	29"	\$733	+\$73	+\$37	+\$237	+\$722
	<b>INBWVDO424230</b>	42"	29"	\$886	+\$90	+\$46	+\$286	+\$859
	<b>INBWVDO484830</b>	48"	29"	\$1066	—	—	+\$343	—
	<b>INBWVDO545430</b>	54"	29"	\$1248	—	—	+\$401	—
	<b>INBWVDO606030</b>	60"	29"	\$1565	—	—	+\$503	—

## Worksurfaces & Supports

Height Adjustable Worksurface  
Electric

# Bench

- Specific worksurfaces must be used in specific applications based on location and end support
- This electric height adjustable table with two motors has a lift capacity of 195lbs (includes worksurface)
- Height adjustment is 28.5" to 44.5"; a total range of 16"
- Base available in Steel Wool, White Velvet or Kettle Black
- Nuform and Laminate
- Straight & Tapered edge available on Nuform
- End units are ½" shorter in length and Middle units are ½" shorter on each end eliminating potential pinch points
- Can be installed on a Full Height or Partial Height Spine with Full End Support. No mid support is required
- Only to be installed on Full Height Panel option - with either full height end gable or open end leg
- See Inscape Bench Application Guide for more details
- Stretcher bars not required for Height Adjustable worksurfaces

### HANDSET OPTIONS

Included at no additional cost:

1. Handset with Up Down Buttons

**OR**

2. Intuitive Paddle

Optional with upcharge:

3. Handset with Up Down Buttons + Memory Display (+\$92)

**OR**

4. Intuitive Paddle with Bluetooth + Memory Display (+\$92)

### NOTES

In order to get a total cost on products when upcharges are present take the list price of the product number and add the upcharge cost shown to the list price.

For example:

Product INBELAKM2448 in Grade 1 laminate would be \$3869 +\$140

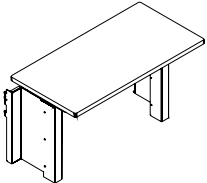
	Part number	W	D	Nuform classic/ laminate/ base price	Nuform select	Nuform tapered	Grade 1 laminate	Grade 2 laminate	Accent paint
	<b>INBELAKM2448</b>	47"	23.675"	\$3869	+\$47	+\$23	+\$140	+\$326	+\$389
	<b>INBELAKM2454</b>	53"	23.675"	\$3915	+\$53	+\$29	+\$158	+\$330	+\$395
	<b>INBELAKM2460</b>	59"	23.675"	\$3963	+\$57	+\$31	+\$173	+\$343	+\$399
	<b>INBELAKM2472</b>	71"	23.675"	\$4062	+\$67	+\$34	+\$209	+\$369	+\$410

24" D Electric  
Height Adjustable  
Worksurface  
Middle Application

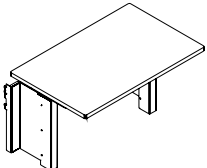
	<b>INBELAKM3048</b>	47"	29.675"	\$3963	+\$51	+\$23	+\$173	+\$367	+\$399
	<b>INBELAKM3054</b>	53"	29.675"	\$4022	+\$63	+\$29	+\$196	+\$371	+\$404
	<b>INBELAKM3060</b>	59"	29.675"	\$4086	+\$71	+\$31	+\$216	+\$374	+\$412
	<b>INBELAKM3072</b>	71"	29.675"	\$4206	+\$85	+\$34	+\$259	+\$383	+\$424

30" D Electric  
Height Adjustable  
Worksurface  
Middle Application

	<b>INBELAKE2448</b>	50.25"	23.675"	\$4062	+\$47	+\$23	+\$145	+\$342	+\$410
	<b>INBELAKE2454</b>	56.25"	23.675"	\$4113	+\$53	+\$29	+\$165	+\$347	+\$414
	<b>INBELAKE2460</b>	62.25"	23.675"	\$4162	+\$57	+\$31	+\$182	+\$361	+\$418
	<b>INBELAKE2472</b>	74.75"	23.675"	\$4262	+\$67	+\$34	+\$219	+\$388	+\$429

24" D Electric Height  
Adjustable Worksurface  
Full End Gable Application



# Worksurfaces & Supports

Height Adjustable Worksurface  
Electric

# Bench

- Specific worksurfaces must be used in specific applications based on location and end support
- This electric height adjustable table with two motors has a lift capacity of 195lbs (includes worksurface)
- Height adjustment is 28.5" to 44.5"; a total range of 16"
- Base available in Steel Wool, White Velvet or Kettle Black
- Nuform and Laminate
- Straight & Tapered edge available on Nuform
- End units are ½" shorter in length and Middle units are ½" shorter on each end eliminating potential pinch points
- Can be installed on a Full Height to Partial Height Spine with Full able End support. No mid support is required
- Only to be installed on Full Height Panel option - with either full height end gable or open end leg
- See Inscape Bench Application Guide for more details
- Stretcher bars not required for Height Adjustable worksurfaces

## HANDSET OPTIONS

Included at no additional cost:

1. Handset with Up Down Buttons

**OR**

2. Intuitive Paddle

Optional with upcharge:

3. Handset with Up Down Buttons + Memory Display (+\$92)

**OR**

4. Intuitive Paddle with Bluetooth + Memory Display (+\$92)

## NOTES

In order to get a total cost on products when upcharges are present take the list price of the product number and add the upcharge cost shown to the list price.

For example:

Product INBELAKE3048 in Grade 1 laminate would be \$4162 +\$182

	Part number	W	D	Nuform classic/ laminate/ base price	Nuform select	Nuform tapered	Grade 1 laminate	Grade 2 laminate	Accent paint
	<b>INBELAKE3048</b>	50.25"	29.675"	\$4162	+\$51	+\$23	+\$182	+\$386	+\$418
	<b>INBELAKE3054</b>	56.25"	29.675"	\$4224	+\$63	+\$29	+\$205	+\$391	+\$426
	<b>INBELAKE3060</b>	62.25"	29.675"	\$4290	+\$70	+\$31	+\$228	+\$394	+\$431
	<b>INBELAKE3072</b>	74.75"	29.675"	\$4416	+\$85	+\$34	+\$274	+\$402	+\$443

30" D Electric Height  
Adjustable Worksurface  
Full End Gable Application



	<b>INBELAKO2448</b>	50.536"	23.675"	\$4062	+\$47	+\$23	+\$145	+\$342	+\$410
	<b>INBELAKO2454</b>	56.536"	23.675"	\$4113	+\$53	+\$29	+\$165	+\$347	+\$414
	<b>INBELAKO2460</b>	62.536"	23.675"	\$4162	+\$57	+\$31	+\$182	+\$361	+\$418
	<b>INBELAKO2472</b>	74.536"	23.675"	\$4262	+\$67	+\$34	+\$219	+\$388	+\$429

24" D Electric Height  
Adjustable Worksurface  
Open End Leg Application



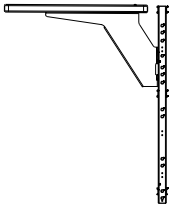
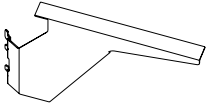

	<b>INBELAKO3048</b>	50.536"	29.675"	\$4162	+\$51	+\$23	+\$182	+\$386	+\$418
	<b>INBELAKO3054</b>	56.536"	29.675"	\$4224	+\$63	+\$29	+\$205	+\$391	+\$426
	<b>INBELAKO3060</b>	62.536"	29.675"	\$4290	+\$70	+\$31	+\$228	+\$394	+\$431
	<b>INBELAKO3072</b>	74.536"	29.675"	\$4416	+\$85	+\$34	+\$274	+\$402	+\$443

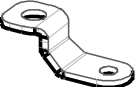
30" D Electric Height  
Adjustable Worksurface  
Open End Leg Application

- Cantilever brackets support worksurfaces at mid-span
- Spacers are to be specified in conjunction with 22.5" id cases and 3/8" thick tops to support worksurfaces
- A Bench 30"d Single Sided Electric Height Adjustable table must have rear glides at every height adjustable support bracket anchored to a concrete floor using the Leg Anchor Bracket and customer supplied 3/8"-16 x 2.25" (min.) concrete anchor studs. See installation manual for further details.

		Part number	H	Eco black/ base price	Neutral paint	Accent paint
	Cantilever Bracket Fixed Height Handed	<b>INBRHCB</b> right-handed	—	\$92	+\$7	+\$12
		<b>INBLHCB</b> left-handed	—	\$92	+\$7	+\$12
	120° Cantilever Bracket	<b>INB120CB</b>	—	\$79	+\$13	+\$11
	Spacers (pkg.4)	<b>WSPACERLAT</b> For Laterals	1.3"	\$69	—	+\$10
		<b>WSPACERPED</b> For Pedestals	1.3"	\$36	—	+\$7
		Part number	H	Neutral paint base price	Accent paint	
	Leg Anchor Bracket	<b>INBLABKT</b>	—	\$59	+\$8	

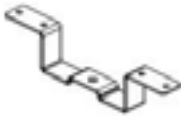
- Pedestal brackets dock pedestal cases to the benching spine. See Inscape Bench Application Guide
- Frame to Worksurface is to be specified in certain configurations where storage is the anchor. See Inscape Bench Application Guide
- Stretcher bars are required to be specified with worksurfaces 54" and wider which do have any mid support
- Stretcher bars are also required for all 30" or deeper worksurfaces no matter the width including when mid cantilever is installed
- Be sure stretcher bars do not to interfere with support brackets, cable trays or other work tools
- Stretcher bars not required for Height Adjustable worksurfaces
- Stretcher bars are 1 1/2" H





		Part number	H	Eco black/ base price	Neutral paint	Accent paint
	Pedestal Bracket, End Location	<b>INBPEDLHBREDE</b> left-handed (illustrated)	—	\$92	—	+\$12
		<b>INBPEDRHBREDE</b> right-handed	—	\$92	—	+\$12
	Pedestal Bracket, Middle Location	<b>INBPEDLHBRMDE</b> left-handed (illustrated)	—	\$92	—	+\$12
		<b>INBPEDRHBRMDE</b> right-handed	—	\$92	—	+\$12
	Frame to Worksurface Connection Bracket	<b>INBSPWSBRKT</b> Double Sided	—	\$91	—	+\$12
		<b>INBSPWBRKTSS</b> Single Sided	—	\$92	—	+\$12
	Worksurface Stretcher Bar For use with worksurfaces 54" and wider	<b>INSBK54</b> For use with 54" surface	44"	—	\$77	—
		<b>INSBK60</b> For use with 60" surface	50"	—	\$114	—
		<b>INSBK72</b> For use with 72" surface	62"	—	\$135	—
		<b>INSBK84</b> For use with 84" surface	74"	—	\$162	—
		<b>INSBK96</b> For use with 96" surface	86"	—	\$183	—

# Worksurfaces & Supports

Worksurfaces Supports  
90° Application

# Bench

- 90° worksurface to spine support brackets support a 90° worksurface at the end of a spine frame at 28.5" H. These brackets are handed left or right and there is a double sided option
- The handedness of the support bracket is determined from the user perspective (i.e. a left handed bracket would install on the left hand side of the user)
- Shared worksurface support brackets are used to support either a 30" D or 36" D shared worksurface off of a spine frame(s) and are available in on module and mid module applications. See Inscape Bench Application Guide for application guidelines
- Brackets are available in all of Inscape's standard paint colors



		Part number	H	Neutral paint/ base price	Accent paint	
 Left hand bracket	90° Worksurface to Spine Support Bracket	<b>INBWSBPERPLH</b>	—	\$172	+\$20	
		Single left hand bracket				
		<b>INBWSBPERPRH</b>	—	\$172	+\$20	
Single right hand bracket						
 Back to back bracket		<b>INBWSBPERPBB</b>	—	\$255	+\$27	
		Double sided back-to-back bracket				
 On module	Shared Worksurface Support Bracket	<b>INWSHBRKT-OM</b>	—	\$126	+\$16	
		For on module applications				
 Mid module		<b>INWSHBRKT-OFF</b>	—	\$240	+\$26	
		For mid module applications				

# Worksurfaces & Supports

Worksurfaces Supports  
90° Application

# Bench

- Height Adjustable Foot Docking Bracket must be specified when spine is freestanding with height adjustable tables
- Height Adjustable Foot Docking Bracket for use with no accessories can only be used in 90° applications
- Height Adjustable Foot Docking Bracket for use with accessories can only be used in 90° applications
- The angled wood fixed worksurface support leg supports the end of a 90° or shared worksurface that is not bracketed to the spine frames
- Wood support legs are available in Clear Oak (default), Black Oak and Clear Maple finishes
- ¼" Tapcon Masonry Screws are NOT included with the Anchor Bracket

		Part number	H	Neutral paint/ base price	Accent paint
 With Accessories	Height Adjustable Foot Docking Bracket	<b>INBHAFDBRKTACCY</b>	—	\$24	+\$6
		For Bench Spine with Accessories Attached			
 No Accessories	Height Adjustable Foot Docking Bracket	<b>INBHAFDBRKTACCN</b>	—	\$24	+\$6
		For Bench Spine with No Accessories			

		Part number	H	List price
	Angled Wood Fixed Worksurface Support Leg	<b>TANGCONPL28.5</b>	27 ¾"	\$504
		Single leg		

## Worksurfaces & Supports

Worksurfaces Supports  
Parallel Application

# Bench

- Freestanding Height Adjustable Foot Docking Bracket can be specified to dock the non-mobile Height Adjustable Tables to a T Foot in parallel applications

		Part number	H	Neutral paint/ base price	Accent paint
	Freestanding Height Adjustable Foot Docking Bracket for parallel applications	<b>INBHAFDBRKTPARL</b>	—	\$29	—





- 3/8" thick tops are available in Nuform (straight edge) and Laminate
- Tops are specified on 22.5" id cases along with spacers to support surfaces at 28.5" H
- Pedestal top depths are sized so that the tops line up flush with the front of the pedestals and go all the way to the front of the tile behind, covering the docking bracket space
- Tops are not available with plywood edge band

**NOTES**

In order to get a total cost on products when upcharges are present take the list price of the product number and add the upcharge cost shown to the list price.

For example:

Product INSWTOP1836 in Grade 1 laminate would be \$238 +\$77

	Part number	W	D	Nuform classic/ laminate/ base price	Nuform select	Grade 1 laminate
 22" D x 3/8" T Pedestal Top	<b>INBPEDTOP1522</b>	15"	23 5/8"	\$111	+\$17	+\$36
	For Storage with Handles					
 28" D x 3/8" T Pedestal Top	<b>INBPEDTOP1522.7</b>	15"	24 1/3"	\$124	+\$15	+\$42
	For 9900 series					
 28" D x 3/8" T Pedestal Top	<b>INBPEDTOP1528</b>	15"	29 5/8"	\$138	+\$17	+\$47
	For Storage with Handles					
 18" D x 3/8" T Lateral Top	<b>INBPTOP1528.7</b>	15"	30 1/3"	\$145	+\$25	+\$49
	For 9900 series					
 18" D x 3/8" T Lateral Top	<b>INSWTOP1830</b>	30"	18"	\$221	+\$15	+\$72
	<b>INSWTOP1836</b>	36"	18"	\$238	+\$35	+\$77
	<b>INSWTOP1842</b>	42"	18"	\$267	+\$45	+\$88
	<b>INSWTOP1848</b>	48"	18"	\$295	+\$52	+\$97
	<b>INSWTOP1854</b>	54"	18"	\$328	+\$53	+\$106
	<b>INSWTOP1860</b>	60"	18"	\$507	+\$56	+\$165
	<b>INSWTOP1872</b>	72"	18"	\$605	+\$63	+\$196
<b>INSWTOP1878</b>	78"	18"	\$704	+\$73	+\$227	

# Worksurfaces & Supports

Worksurfaces Supports  
Full Gable

# Bench

- When specifying a Full Gable End Supports, choose the base, then option of inside and outside tiles and finally choose the worksurface support option
- Full Gable End Supports have options of Nuform, laminate, paint or no tile
- Full Gable Mid Support is available in paint and no tile
- Option "NO" interior tile when a Trading Desk unit is being installed
- Nuform and Laminate with a pattern will run the length of the gable
- Full Gable Supports must be used with Full Height Spine Frames
- For single-sided applications, use 18" mid supports for 24" D surfaces and 24" mid supports for 30" D surfaces
- Nuform Herringbone tile options is only available on the outside of the end gable.

## NOTES

In order to get a total cost on products when upcharges are present take the list price of the product number and add the upcharge cost shown to the list price.

For example:

Product INBFEG28.548 with inside and outside in Laminate with fixed height worksurfaces supports on both sides would be \$915 +\$807 +\$886 +\$220

Product number	H	W	Neutral paint/ base price	Accent paint	Inside tile finish options					
					No tile	Paint	Nuform classic	Nuform select	Laminate	Grade 1 laminate
<b>INBFEG28.548</b>	28 1/2"	48"	\$915	+\$94	+\$0	+\$162	+\$524	+\$582	+\$807	+\$826
<b>INBFEG28.560</b>	28 1/2"	60"	\$987	+\$101	+\$0	+\$341	+\$546	+\$606	+\$814	+\$882

Product number	Outside tile finish options							
	No tile	Paint	Nuform classic	Nuform select	Nuform Herringbone classic	Nuform Herringbone select	Laminate	Grade 1 laminate
<b>INBFEG28.548</b>	—	+\$228	+\$886	+\$984	+\$991	+\$1100	+\$886	+\$944
<b>INBFEG28.560</b>	—	+\$231	+\$945	+\$1050	+\$1058	+\$1174	+\$945	+\$1035



Full Gable End Support

## Worksurface support options

Product number	Fixed height	Manual Height Adjustable	Electric Height Adjustable	Electric and Manual Height Adjustable	Electric Height Adjustable & Fixed	Manual Height Adjustable & Fixed
<b>INBFEG28.548</b>	+\$220	+\$220	—	+\$111	+\$111	+\$220
<b>INBFEG28.560</b>	+\$220	+\$220	—	+\$111	+\$111	+\$220



# Worksurfaces & Supports

Worksurfaces Supports  
Full Gable

# Bench

- When specifying a Full Gable End Supports, choose the base, then option of inside and outside tiles and finally choose the worksurface support option
- Full Gable End Supports have options of Nuform, laminate, paint or no tile
- Full Gable Mid Support is available in paint and no tile
- Option "NO" interior tile when a Trading Desk unit is being installed
- Nuform and Laminate with a pattern will run the length of the gable
- Full Gable Supports must be used with Full Height Spine Frames
- For single-sided applications, use 18" mid supports for 24" D surfaces and 24" mid supports for 30" D surfaces

- Nuform Herringbone tile options is only available on the outside of the end gable.

### NOTES

In order to get a total cost on products when upcharges are present take the list price of the product number and add the upcharge cost shown to the list price.

For example:

Product INBFEG28.548 with inside and outside in Laminate with fixed height worksurfaces supports on both sides would be \$915 +\$807 +\$886 +\$220

Product number	H	W	Neutral paint/ base price	Accent paint	Inside tile finish options					
					No tile	Paint	Nuform classic	Nuform select	Laminate	Grade 1 laminate
<b>INBSFEG28.524</b>	28 1/2"	24"	\$567	+\$59	+\$0	+\$121	+\$465	+\$516	+\$465	+\$495
<b>INBSFEG28.530</b>	28 1/2"	30"	\$611	+\$63	+\$0	+\$125	+\$496	+\$550	+\$496	+\$544

Product number	Outside tile finish options							
	No tile	Paint	Nuform classic	Nuform select	Nuform Herringbone classic	Nuform Herringbone select	Laminate	Grade 1 laminate
<b>INBSFEG28.524</b>	—	+\$121	+\$465	+\$516	+\$521	+\$578	+\$465	+\$495
<b>INBSFEG28.530</b>	—	+\$125	+\$496	+\$550	+\$556	+\$617	+\$496	+\$544

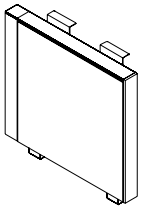

### Worksurface support options

Product number	Fixed height	Manual Height Adjustable	Electric Height Adjustable	Electric and Manual Height Adjustable	Electric Height Adjustable & Fixed	Manual Height Adjustable & Fixed
<b>INBSFEG28.524</b>	+\$111	+\$111	—	—	—	—
<b>INBSFEG28.530</b>	+\$111	+\$111	—	—	—	—

Single-Sided Full  
Gable End Support

# Worksurfaces & Supports

Worksurfaces Supports  
Full Gable

# Bench

- When specifying a Full Gable End Supports, choose the base, then option of inside and outside tiles and finally choose the worksurface support option
- Full Gable End Supports have options of Nuform, laminate, paint or no tile
- Full Gable Mid Support is available in paint and no tile
- Option "NO" interior tile when a Trading Desk unit is being installed
- Nuform and Laminate with a pattern will run the length of the gable
- Full Gable Supports must be used with Full Height Spine Frames
- For single-sided applications, use 18" mid supports for 24" D surfaces and 24" mid supports for 30" D surfaces

- 36" D single-sided Bench applications are not available
- Nuform Herringbone tile options is only available on the outside of the end gable.

### NOTES

In order to get a total cost on products when upcharges are present take the list price of the product number and add the upcharge cost shown to the list price.

For example:

Product INBFEG28.512 with inside and outside in paint with fixed height worksurfaces supports on both sides would be \$682

Product number	H	W	Neutral paint/ base price	Accent paint	Inside tile finish options					
					No tile	Paint	Nuform classic	Nuform select	Laminate	Grade 1 laminate
<b>INBFEG28.512</b>	28 ½"	12"	\$682	+\$70	-\$92	\$0	—	—	—	—
<b>INBFEG28.518</b>	28 ½"	18"	\$714	+\$73	-\$104	\$0	—	—	—	—
<b>INBFEG28.524</b>	28 ½"	24"	\$748	+\$77	—	\$0	—	—	—	—

Product number	Outside tile finish options							
	No tile	Paint	Nuform classic	Nuform select	Nuform Herringbone classic	Nuform Herringbone select	Laminate	Grade 1 laminate
<b>INBFEG28.512</b>	-\$92	+\$0	—	—	—	—	—	—
<b>INBFEG28.518</b>	-\$104	+\$0	—	—	—	—	—	—
<b>INBFEG28.524</b>	—	+\$0	—	—	—	—	—	—



Full Gable Mid Support

### Worksurface support options

Product number	Fixed height	Manual Height Adjustable	Electric Height Adjustable	Electric and Manual Height Adjustable	Electric Height Adjustable & Fixed	Manual Height Adjustable & Fixed	Manual height adjustable (M) on left & fixed (F) on right	Fixed (F) on left & manual height adjustable (M) on right
<b>INBFEG28.512</b>	—	—	—	—	—	—	—	—
<b>INBFEG28.518</b>	—	—	—	—	—	—	—	—
<b>INBFEG28.524</b>	—	—	—	—	—	—	—	—

M	F	F	M
---	---	---	---

# Worksurfaces & Supports

Worksurfaces Supports  
Full Gable Brackets

- Brackets for field reconfiguration purposes only
- The handedness of these brackets is chosen from the user perspective of the fixed worksurface

	Part number	H	D	Neutral paint/ base price	Accent paint
 <p>Full Gable Mid Support Bracket Only for Supporting 2 Fixed Height Surfaces</p>	<b>INBKTEGFF12</b>	28 ½"	12"	\$98	+\$13
	12" D Full Gable				
	<b>INBKTEGFF18</b>	28 ½"	18"	\$105	+\$13
	18" D Full Gable				
	<b>INBKTEGFF24</b>	28 ½"	24"	\$114	+\$15
	24" D Full Gable				

# Worksurfaces & Supports

Worksurfaces Supports

Open A Leg

# Bench

- When specifying an Open A Leg Support, choose the base, then choose the worksurface support option
- Can be used with Partial Height Spine Frames only
- A Legs have a lower cover included when electric height adjustable worksurface supports are optioned
- Manual height adjustable is not available for use with the A Leg due to partial height bench frame restrictions
- 36" D applications are not available with the A Leg

## NOTES

In order to get a total cost on products when upcharges are present take the list price of the product number and add the upcharge cost shown to the list price.

For example:

Product INBAALEG28.548 with fixed worksurfaces supports on both sides would be \$834 +\$204



	Part number	H	W	Neutral paint/ base price	Accent paint
Open A Leg End Support For use with regular height applications	<b>INBAALEG28.548</b>	28 ½"	48"	\$834	+\$105
	<b>INBAALEG28.560</b>	28 ½"	60"	\$875	+\$110

### Worksurface support options

Product number	Fixed height	Manual Height Adjustable	Electric Height Adjustable	Electric and Manual Height Adjustable	Electric Height Adjustable & Fixed	Manual Height Adjustable & Fixed
<b>INBAALEG28.548</b>	+\$204	—	+\$0	—	+\$102	—
<b>INBAALEG28.560</b>	+\$215	—	+\$0	—	+\$108	—

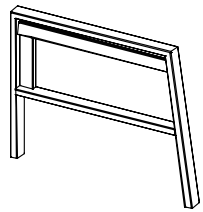

	Part number	H	W	Neutral paint/ base price	Accent paint
Single-Sided Open A Leg End Support For use with regular height applications	<b>INBAAEG28.524LH</b> left-handed (illustrated)	28 ½"	24"	\$660	+\$76
	<b>INBAAEG28.524RH</b> right-handed	28 ½"	24"	\$660	+\$76
	<b>INBAAEG28.530LH</b> left-handed (illustrated)	28 ½"	30"	\$847	+\$78
	<b>INBAAEG28.530RH</b> right-handed	28 ½"	30"	\$684	+\$78

### Worksurface support options

Product number	Fixed height	Manual Height Adjustable	Electric Height Adjustable	Electric and Manual Height Adjustable	Electric Height Adjustable & Fixed	Manual Height Adjustable & Fixed
<b>INBAAEG28.524LH</b>	+\$77	—	+\$0	—	—	—
<b>INBAAEG28.524RH</b>	+\$77	—	+\$0	—	—	—
<b>INBAAEG28.530LH</b>	+\$83	—	+\$0	—	—	—
<b>INBAAEG28.530RH</b>	+\$83	—	+\$0	—	—	—

# Worksurfaces & Supports

Worksurfaces Supports

Open A Leg

# Bench

- Can be used with Partial Height Spine Frames only
- For double-sided applications, use 12" mid supports for 24"D surfaces and 18" mid supports for 30"D surfaces
- For single-sided applications, use 18" mid supports for 24"D surfaces and 24" mid supports for 30" D surfaces
- 36"D applications are not available with the A Leg

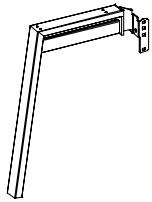

Open A Leg Mid Support  
For use with regular height applications

Part number	H	W	Neutral paint/ base price	Accent paint
<b>INBAEG28.512</b>	28 ½"	12"	\$429	+\$45
<b>INBAEG28.518</b>	28 ½"	18"	\$453	+\$47
<b>INBAEG28.524</b>	28 ½"	24"	\$522	+\$53

### Worksurface support options

Product number	Fixed height	Manual Height Adjustable	Electric Height Adjustable	Electric and Manual Height Adjustable	Electric Height Adjustable & Fixed	Manual Height Adjustable & Fixed	Manual height adjustable (M) on left & fixed (F) on right	Fixed (F) on left & manual height adjustable (M) on right
<b>INBAEG28.512</b>	—	—	—	—	—	—	—	—
<b>INBAEG28.518</b>	—	—	—	—	—	—	—	—
<b>INBAEG28.524</b>	—	—	—	—	—	—	—	—

M	F	F	M
---	---	---	---

# Worksurfaces & Supports

Worksurfaces Supports  
Open H Leg

- When specifying an Open H Leg Support, choose the base, then choose the worksurface support option
- Can be used with Full Height, Partial Height and Storage Spine Frames
- Regular height (28.5") available
- Has the ability to support various accessories which hang from the support bar of the leg
- When the Electric Height Adjustable worksurface support option is selected there will be exposed bracket mounting holes visible. For no holes, specify For Electric Height Adjustable Application Only

### NOTES

In order to get a total cost on products when upcharges are present take the list price of the product number and add the upcharge cost shown to the list price.

For example:

Product INBAHLEG28.548 with fixed height worksurfaces supports on both sides would be \$1196 +\$278

	Part number	H	W	Neutral paint/ base price	Accent paint
 Open H Leg End Support For use with regular height applications	<b>INBAHLEG28.548</b>	28 ½"	48"	\$1196	+\$123
	<b>INBAHLEG28.560</b>	28 ½"	60"	\$1219	+\$125

#### Worksurface support options

Product number	Fixed height	Manual Height Adjustable	Electric Height Adjustable	Electric and Manual Height Adjustable	Electric Height Adjustable & Fixed	Manual Height Adjustable & Fixed
<b>INBAHLEG28.548</b>	+\$278	+\$125	+\$0	+\$63	+\$140	+\$201
<b>INBAHLEG28.560</b>	+\$278	+\$125	+\$0	+\$63	+\$140	+\$201

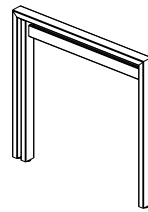
	Part number	H	W	Neutral paint/ base price	Accent paint
 Single-Sided Open H Leg End Support For use with regular height applications	<b>INBAHEG28.524LH</b> left-handed (illustrated)	28 ½"	24"	\$791	+\$83
	<b>INBAHEG28.524RH</b> right-handed	28 ½"	24"	\$791	+\$83
	<b>INBAHEG28.530LH</b> left-handed (illustrated)	28 ½"	30"	\$847	+\$88
	<b>INBAHEG28.530RH</b> right-handed	28 ½"	30"	\$847	+\$88

#### Worksurface support options

Product number	Fixed height	Manual Height Adjustable	Electric Height Adjustable	Electric and Manual Height Adjustable	Electric Height Adjustable & Fixed	Manual Height Adjustable & Fixed
<b>INBAHEG28.524LH</b>	+\$140	+\$63	+\$0	—	—	—
<b>INBAHEG28.524RH</b>	+\$140	+\$63	+\$0	—	—	—
<b>INBAHEG28.530LH</b>	+\$140	+\$63	+\$0	—	—	—
<b>INBAHEG28.530RH</b>	+\$140	+\$63	+\$0	—	—	—

# Worksurfaces & Supports

Worksurfaces Supports  
Open H Leg

- Can be used with Full Height, Partial Height and Storage Spine Frames
- For double-sided applications, use 12" mid supports for 24"D surfaces, 18" mid supports for 30"D surfaces and 24" mid supports for 36"D surfaces
- For single-sided applications, use 18" mid supports for 24"D surfaces and 24" mid supports for 30"D surfaces
- Covers for "H" leg are specified when the holes on the interior of the leg are exposed when electric height adjustable is specified. These covers come 4 in a package and two are required under each worksurface



	Part number	H	W	Neutral paint/ base price	Accent paint
Open H Leg Mid Support For use with regular height applications	<b>INBHEG28.512</b>	28 ½"	12"	\$435	+\$47
	<b>INBHEG28.518</b>	28 ½"	18"	\$485	+\$51
	<b>INBHEG28.524</b>	28 ½"	24"	\$557	+\$58

### Worksurface support options

Product number	Fixed height	Manual Height Adjustable	Electric Height Adjustable	Electric and Manual Height Adjustable	Electric Height Adjustable & Fixed	Manual Height Adjustable & Fixed	Manual height adjustable (M) on left & fixed (F) on right	Fixed (F) on left & manual height adjustable (M) on right
<b>INBHEG28.512</b>	—	—	—	—	—	—	—	—
<b>INBHEG28.518</b>	—	—	—	—	—	—	—	—
<b>INBHEG28.524</b>	—	—	—	—	—	—	—	—

M	F	F	M
---	---	---	---



	Part number	H	W	Neutral paint/ base price	Accent paint
H Leg Hole Covers	<b>INBHLEGCOVR-4</b>	7/8"	1 3/4"	\$20	+\$6

# Worksurfaces & Supports

Worksurfaces Supports  
Open O Leg

# Bench

- When specifying an Open O Leg Support, choose the base, then choose the worksurface support option
- Open O Leg Supports can be used with Full Height, Partial Height and Storage Spine Frames
- Open O legs have the option to add glazed inserts which are available in clear, gray and etched 1 side glass. See example for how to price glazed inserts
- Has the ability to support various accessories which hang from the support bar of the leg
- Use Open H leg Mid Supports to support mid applications
- For single-sided applications, use 18" mid supports for 24" D surfaces and 24" mid supports for 30" D surfaces
- 36" D single-sided Bench applications are not available

## NOTES

In order to get a total cost on products when upcharges are present take the list price of the product number and add the upcharge cost shown to the list price.

For example:

Product INBAHLEG28.548 with fixed height worksurfaces supports on both sides would be \$1016 +\$278  
Product INBAHLEG28.548 with fixed height worksurfaces supports on both sides and Gray glazed insert would be \$1016 +\$278 + \$466 +\$54

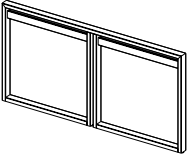
	Part number	H	W	Neutral paint/base price	Glazed Insert options			Accent paint
					Clear/base	Gray	Etched 1 side	
 <p>Open O Leg End Support For use with regular height applications</p>	<b>INBAOLEG28.548</b>	28 ½"	48"	\$1016	\$466	+\$54	+\$162	+\$104
	<b>INBAOLEG28.560</b>	28 ½"	60"	\$1052	\$665	+\$77	+\$229	+\$107

### Worksurface support options

Product number	Fixed height	Manual Height Adjustable	Electric Height Adjustable	Electric and Manual Height Adjustable	Electric Height Adjustable & Fixed	Manual Height Adjustable & Fixed
<b>INBAOLEG28.548</b>	+\$278	+\$125	—	+\$63	+\$140	+\$201
<b>INBAOLEG28.560</b>	+\$278	+\$125	—	+\$63	+\$140	+\$201

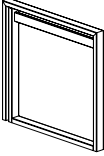
 <p>Single-Sided Open O Leg End Support For use with regular height applications</p>	<b>INBAOEG28.524LH</b>	28 ½"	24"	\$796	\$358	+\$56	+\$105	+\$84	
	left-handed (illustrated)								
	<b>INBAOEG28.524RH</b>	28 ½"	24"	\$796	\$358	+\$56	+\$105	+\$84	
	right-handed								
	<b>INBAOEG28.530LH</b>	28 ½"	30"	\$871	\$400	+\$48	+\$139	+\$90	
left-handed (illustrated)									
	<b>INBAOEG28.530RH</b>	28 ½"	30"	\$871	\$400	+\$48	+\$139	+\$90	
right-handed									

### Worksurface support options

Product number	Fixed height	Manual Height Adjustable	Electric Height Adjustable	Electric and Manual Height Adjustable	Electric Height Adjustable & Fixed	Manual Height Adjustable & Fixed
<b>INBAOEG28.524LH</b>	+\$140	+\$63	—	—	—	—
<b>INBAOEG28.524RH</b>	+\$140	+\$63	—	—	—	—
<b>INBAOEG28.530LH</b>	+\$140	+\$63	—	—	—	—
<b>INBAOEG28.530RH</b>	+\$140	+\$63	—	—	—	—





## Worksurfaces & Supports

### Worksurfaces Supports

For Electric Height Adjustable Application Only

# Bench

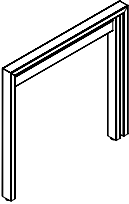
- Supports for Electric Height Adjustable applications only
- No holes will be visible on these supports
- For single-sided applications, use 18" mid supports for 24" D surfaces and 24" mid supports for 30" D surfaces
- 36" D single-sided Bench applications are not available

		Part number	W	D	Neutral paint/ base price	Accent paint
	Open H Leg End Support for Height Adjustable Worksurfaces only For use with regular height applications	<b>INBHLEGHAW48</b>	28 ½"	48"	\$1035	+\$105
		<b>INBHLEGHAW60</b>	28 ½"	60"	\$1041	+\$106
	Single-Sided Open H Leg End Support for Height Adjustable Worksurfaces only For use with regular height applications	<b>INBHLEGHAW24LH</b>	28 ½"	24"	\$642	+\$65
		<b>INBHLEGHAW24RH</b>	28 ½"	24"	\$642	+\$65
		<b>INBHLEGHAW30LH</b>	28 ½"	30"	\$717	+\$73
		<b>INBHLEGHAW30RH</b>	28 ½"	30"	\$717	+\$73
	Full Gable Mid Support for Height Adjustable Worksurfaces only For use with regular height applications	<b>INBFEGADJ12</b>	28 ½"	12"	\$682	+\$70
		<b>INBFEGADJ18</b>	28 ½"	18"	\$693	+\$71
		<b>INBFEGADJ24</b>	28 ½"	24"	\$726	+\$74

# Bench Storage

**inscape**

work for tomorrow

**PEDESTALS**

Pedestals are of all-welded “wrap-around” construction of 20 and 22 gauge high quality, tension leveled, cold rolled steel. The steel gauge selected for drawer fronts, bodies and accessories ensure the highest quality durability and performance for all components. All glides on cases must be specified as flat glides (5/8" height adjustability) to work with Inscape Bench. Pedestal corners are welded at junction of top and case, eliminating horizontal lines for a cleaner, flush appearance, and strengthened with reinforcing gussets. A completely enclosed case provides rigid construction and dust-free interiors.

Box drawer sides are slotted on 1" centers to allow for maximum flexibility for drawer division. Double-wall construction allows lift-up doors to be picked up and recede smoothly, eliminates deformation, ensures flush fit within cabinet and improves lock performance. Storage with Handles is single-wall construction. File (10.5" and 12") and EDP (15") drawer bodies have full height sides to accommodate hanging file folders, eliminating the need for optional file frames. Fully progressive ball bearing suspensions on all drawers, including pencil and box drawers, are staged so that the left and right sides work in unison; this provides smooth drawer operation with minimum force. Staged suspensions allow the drawer to be completely pulled out, providing access to the entire drawer depth.

Special “claw-like” device incorporated in the suspension “grips” the fixed section of the suspension channel preventing drawer body bounce back or creep when drawer is closed. Modular interior allows complete interchangeability of drawer types within the pedestal case. For example, two 6" box drawers may be replaced by a 12" file drawer. Pedestals are standard with keyholes for attachment to underside of worksurface. For the Storage with Handles only cases: 18" deep pedestals come standard with 18" deep drawers, 22" and 28" deep pedestals come standard with 22" deep drawers. For all other Series, pedestal drawers match case depth.

Worksurface supporting pedestals are designed for use with the Inscape Bench when used with flat glides. Worksurface supporting pedestals are available in two depths to fit 24" and 30" deep worksurfaces and support finished worksurface height of 28.5". Pedestals with 3", 6" or 7.5" drawers have the option to order one pencil tray per pedestal. The 6" and 7.5" drawers have the additional option to order a steel divider. The 10.5" and 12" drawers have the option to order hang file suspension bar (two in a 28" deep pedestal) for side-to-side filing of legal or letter size folders or printout binders.

**NOTE: System storage pedestal cases consist of holes in the top of the case and back of the case to allow for worksurface docking and panel mounted brackets to be secured.**

**CUSHION MOBILE PEDESTALS**

The Classic Cushion is 1 1/4" thick CAL 117 compliant polyurethane foam with a 2.2 lb/ft. density. This upholstered cushion is balanced with a 7/16" board and is attached to the pedestal top with heavy duty Velcro.

Select from our graded upholstery program of solid color fabrics and vinyl's or choose COM option (Customers Own Material). To determine if a COM fabric has been pre-approved for use on our cushion topper, contact your client services representative or go to [www.inscapesolutions.com](http://www.inscapesolutions.com). For application of ALL fabrics, both from our graded program as well as COM (Customer Own Material) please specify layout orientation at time of order. If layup instructions are not provided Inscape will choose the direction to maximize production. Refer to the diagram for layup options.

After calculating the total amount of material needed in inches, divide the total number of inches by 36 for the total yardage and round up to the next full yard. Allow additional for repeat. Add 15% of total fabric required for small and medium pattern repeats. Add 20% of total fabric required for large patterns.

Due to the nature of the design and manufacture of our cushion, only approved fabrics will be accepted for application. For a description of the procedure required for COM fabric approval see sample ‘Cushion COM Test Request’ form found in the General Information section of this price list. This form can be downloaded from the Administration section of Insite or by contacting your client services representative for assistance.

**FABRIC LAY UP OF PEDESTAL CUSHIONS**

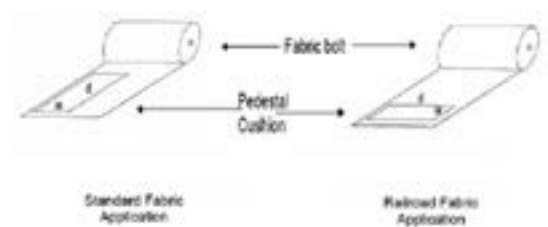

Pedestals come standard with lock. If lock is not required add suffix ‘/NL’ after product number and deduct \$57 list per lock. Random keying is standard, and keyed alike may be ordered.

Locks feature removable core and are standard with two keys, one of which has a black neoprene plastic key cover. Locks may be ordered for field installation. Specify cabinet height and width or model number. Note: Locks cannot be field installed on hinged door cabinets.

## LATERALS

Lateral cabinets are of all-welded construction using 20 and 22 gauge high quality, tension leveled, and cold rolled steel. Drawer fronts, lift-up doors, roll-out shelves and all steel accessories are manufactured of the steel gauge appropriate to function at the highest quality level. Laterals must be specified with flat glides to work with Inscape Bench. Flat Glides provide 0.125" height adjustment when docked and 0.75" height adjustment if unit is not docked.

With the addition of counterweights where appropriate, cabinets meet all BIFMA specifications. All interiors are completely modular and interchangeable so that cabinets can be retrofitted with new accessories and interiors as required. Cabinet corners (except for Storage with Handles) are welded at junction of top and case, eliminating horizontal lines for cleaner, flush appearance, and strengthened with reinforcing gussets. Double-wall construction allows lift-up doors to be picked up and receded smoothly, eliminates deformation, ensures flush fit within cabinet and improves lock performance. Lift-up door carrier mechanism has four nylon rollers two on each side - for smooth receding action with no binding or snagging. Self-closing, 110° opening, European style cupboard hinges for smooth door operations.

The absence of scissor mechanism in doors and drawers eliminates the potential for scissors binding, and facilitates reconfiguration of cabinet openings as needed. Front leading edge of pullout shelves is beaded and rolled to provide grip for pullout action and strengthen shelf; front leading edge of fixed shelf is flat for easy removal of material. Fully progressive ball bearing suspension slides provide smooth action with minimum force.

Special "claw-like" device incorporated in suspension slide channel "grips" the fixed section of the suspension channel preventing drawer bounce-back or creep when drawer is closed. A patented Safelock™ interlock mechanism provides complete security and user safety against accidental opening of two or more drawers simultaneously. Lock fingers are configured with right angle bend upward not downward so that lift-up doors cannot be pulled down to disengage fingers from door slots and be forced to circumvent lock system. Lock bars operate vertically on both sides of cabinet for maximum security.

Knockouts that are included on case sides, top and bottom facilitate ganging and leveling. Glides - 2 in front and 2 in back - are adjustable from inside the cabinet so that cabinets can be leveled regardless of whether they are backed against a wall or banked.

9900 Series fronts have full width integral pulls with enamel finish to match case fronts. Storage with Handles fronts are available with 2 pull options. The standard pull option is the radius aluminum pull. A rectangular aluminum pull option is also available at no additional cost. Storage with Handles is single-wall construction. Nuform fronts include a Q- pull.

Laterals include 1 pair of hang file bars in 10.5" and 12" fixed fronts, 1 EDP kit in 13.5" and 15" fixed fronts, pencil tray in 3" multi-file drawer and steel divider in 7.5" multi-file drawer, steel divider in 6" multi-file drawers and 3 divider plates in 13.5" lift-ups. Fixed shelf in lift-up is slotted in 1" increments. Lateral to panel bracket is required if lateral is positioned on-module.

**NOTE: laterals and multi-files consist of slots in the back of the case to allow for panel mounted brackets to be secured.**

Cabinets ship standard with single bitted lock. For applications requiring higher security a double bitted solution is available. If lock is not required it may be optioned as such. Random keying is standard, keyed alike is optional. Cabinets originally ordered as non-locking may be field installed with the addition of locking bars and a lock core. Contact your client services representative for required parts. Locks may not be field installed in hinged door and sliding door cabinets. Master keys are available; refer to the accessories section to specify. Locks are standard with two keys, one of which has a black neoprene plastic cover.

All laterals are finished in standard 36.5° gloss baked enamel, electrostatically applied in a 2-coat process. Refer to the surface materials section for available colors. With the exception of custom micas, whites and metallic; custom colors are available at an up-charge and are be subject to extended lead times. For laterals specified in custom micas, specials whites or metallic, add an up-charge of 10% to the list price. All interior drawers/shelf bodies, exposed hardware (excluding European style hinges) hang file bars, dividers and media frames are finished in Eco Black.

## TWIN-BINS

Twin-Bins are 5.75" deep on each side of the supporting frame. Twin-Bins may be specified to install in stack frames above the worksurface. Bins are manufactured from minimum 20 gauge steel with an extruded aluminum reinforced top. Double wall, sliding doors on each side of the unit, slide easily across the recessed groove built into the bin front. Twin-Bins are available with or without locks. The locking mechanism is individualized for each side of the unit, allowing for personal privacy on either side. Twin-Bins are available in 36", 42", 48" and 60" W. Recommended maximum load for Twin-Bins is 3lbs per linear inch. Bins are finished in standard 37.5° gloss baked enamel, electrostatically applied in a 2-coat process and are available in any of the colors shown in our Color Guide. Woodgrain fronts are available in any of our standard woodgrain finishes.

Handles are standard in aluminum finish and are located on the front of the sliding door. Case may still be ordered in any of the colors shown in our Color Guide.

## ELECTRIFIED TWIN BIN

The Electrified Twin Bin is built on the same premise as the standard Twin Bin with the addition of electrical and a sliding door with locking capabilities in two positions. All electrical components are specified separately including power track, receptacles and jumper cables. The sliding door may lock either the binder storage portion (full depth of bin) or the electrified portion which is the center portion which is approximately 5"D. The back of the Electrified Twin Bin may be clad with either a tackboard or whiteboard which are both specific to this storage unit. A shelf may also be optioned for the electrified portion which is field installed midway between top and bottom of opening. A gap in the shelf allows for the cord of an electronic unit to plug into duplex (located near base of opening) and still sit on top of shelf.

**NOTE: These accessories are NOT compatible with the standard Twin Bin.**

See Inscape Bench Application Guide for criteria on which heights of stack-on to use in conjunction with the Twin Bin and Electrified Twin Bin.

## SPECIFY TWIN-BIN MOUNTING BRACKETS

Specify Twin-Bin Mounting Brackets separately according to location on frame. 1 bracket per Twin-Bin is required. When stacking Twin-Bins a 6.75" H tile minimum must separate the two. Do not specify over Power Track Kit. It is not recommended to specify Twin-Bins on wing panels. Twin-Bins should only be specified on spine panels for adequate stability. See Inscape Bench Application Guide for details.

## DRAWER STANDARD EQUIPMENT

Lockers and towers containing 3" or 6" drawers are provided with one pencil tray per cabinet. 6" drawers are additionally standard with one steel divider. 10.5", 12" and 15" letter-width file drawers have one suspension bar for side-to-side filing of letter or legal-size folders. Full-width pullout drawers are standard with one pair hang file bars for side-to-side suspended filing. Full-width fixed shelves are standard with 3 plate dividers. Optional accessories are available.



## GLIDES

Overall heights are inclusive of metal glides. Heights may be increased up to 5/8" by extending the standard glide. Glides are accessible from inside the cabinet when the bottom drawer is fully extended or removed and may be adjusted with a 0.25" socket driver. Optional 1.5" stem glides are available. Specify and add \$24 list to the cabinet price. Requires field installation.

**FRONT DETAILS & PULL OPTIONS**

9900 Series fronts have full width integral pulls with enamel finish to match case fronts.

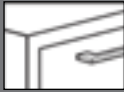
Storage with Handles have the following styles options. FP005 is the default pull.

Pull	Storage with Handles
 <b>FP001</b> P290 Aluminum Leaf Finish	●
 <b>FP004</b> Brushed Nickel Finish	●
 <b>FP005</b> Satin Nickel Finish	●

● Available    ○ Unavailable

Pulls FP004 and FP005 meet the guidelines for ADA compliance.

**LOCKS**

Workplace Towers and Lockers come standard with lock with single bitted lock. For applications requiring higher security, a double bitted solution is available. If lock is not required add suffix '**/NL**' after product number. Deduct \$57 list per lock.

Locks are available in chrome and black finish. Specify. Random keying is standard. Files may be ordered keyed alike. Locks feature removable core and are standard with two keys, one of which has a black Neoprene plastic key cover. Cabinets originally ordered as non-locking may be field installed with the addition of locking bars and a lock core. Please contact Inscape Client Services for required parts. Locks may not be field installed in hinged and sliding door cabinets. Specify lateral file height and width or model number. Master keys are available at \$51 list.

**CUSTOM COLORS**

Inscape System offers color matched to a customers' specification when possible. This matching is done through a database of over 2,000 existing color formulas or the development of a new custom color. A minimum order value of \$3,000 net per custom color, applies to each order. A \$250 net fee applies for each custom color below this minimum. In addition, Custom premium colors (bright whites and bright colors; textured paints; and reflection paints that use mica, aluminum or special chemical to create their reflective properties) will be subject to a 10% upcharge to the net value of the product.



- Includes holes in top and bracket slots in back of case
- Worksurface supporting for 28.5" H
- Be sure to specify a 3/8" top along with spacers to achieve a 28.5" finished worksurface height
- **FLAT GLIDE ONLY** when used with Inscape Bench

### OPTIONAL ACCESSORIES

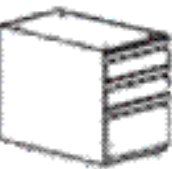

All pedestal accessories are optional. See chart below for information an accessories by drawer height.

Drawer Height	Product Code	Product Description	Price
3" & 4.5"	PFWS-PTxx	Pencil Tray	\$37
6" & 7.5"	PFWS-PTxx	Pencil Tray	\$37
	PFWS-DVxx	Divider	\$22
18"D, 22"D, 28"D Pedestals Only (28"D requires 2 per drawer)			
10.5", 12", 13.5, & 15"	PFSSFxx	Side-To-Side Filing Bar	\$8

Visit the [Pedestal Accessories](#) section for full accessory details.



	Part number	H	W	D	Wt (lbs)	Neutral paint/ base price	Accent paint
	<b>INGE1522-F10F</b>	25 3/8"	15"	22 3/4"	95	\$914	+\$94
	<b>INGE1528-F10F</b> Letter Width	25 3/8"	15"	28 3/4"	105	\$950	+\$98
	<b>INGE1522-2BF10</b>	25 3/8"	15"	22 3/4"	95	\$1036	+\$105
	<b>INGE1528-2BF10</b> Letter Width	25 3/8"	15"	28 3/4"	105	\$1086	+\$111
	<b>INGE1522-PB7F</b>	25 3/8"	15"	22 3/4"	95	\$1038	+\$106
	<b>INGE1528-PB7F</b> Letter Width	25 3/8"	15"	28 3/4"	105	\$1090	+\$111

- Worksurface supporting for 28.5" H
- Be sure to specify a 3/8" top along with spacers to achieve a 28.5" finished worksurface height
- **FLAT GLIDE ONLY** when used with Inscape Bench

		Part number	H	W	D	Wt (lbs)	Neutral paint/ base price	Accent paint
	10.5" file, 12" file Flat Glides	<b>3022.5H-F10F</b>	25 3/8"	30"	18"	—	\$1083	+\$110
		<b>3622.5H-F10F</b>	25 3/8"	36"	18"	—	\$1188	+\$121
		<b>4222.5H-F10F</b>	25 3/8"	42"	18"	—	\$1306	+\$133
	3" pencil, 7.5" box, 12" file Flat Glides	<b>3022.5H-PB7F</b>	25 3/8"	30"	18"	—	\$1112	+\$114
		<b>3622.5H-PB7F</b>	25 3/8"	36"	18"	—	\$1212	+\$125
		<b>4222.5H-PB7F</b>	25 3/8"	42"	18"	—	\$1331	+\$135





- Worksurface supporting for 28.5" H
- Be sure to specify a 3/8" top along with spacers to achieve a 28.5" finished worksurface height
- **FLAT GLIDE ONLY** when used with Inscape Bench

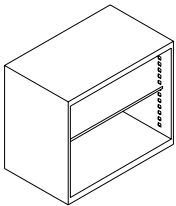

		Part number	H	W	D	Wt (lbs)	Neutral paint/ base price	Accent paint
	10.5" file, 12" file Flat Glides	<b>IN3022.5E-F10F</b>	25 3/8"	30"	18"	—	\$1095	+\$111
		<b>IN3622.5E-F10F</b>	25 3/8"	36"	18"	—	\$1200	+\$123
		<b>IN4222.5E-F10F</b>	25 3/8"	42"	18"	—	\$1318	+\$134
	2-6" box, 10.5" file Flat Glides	<b>IN3022.5E-2BF10</b>	25 3/8"	30"	18"	—	\$1251	+\$128
		<b>IN3622.5E-2BF10</b>	25 3/8"	36"	18"	—	\$1384	+\$140
		<b>IN4222.5E-2BF10</b>	25 3/8"	42"	18"	—	\$1511	+\$153
	3" pencil, 7.5" box, 12" file Flat Glides	<b>IN3022.5E-PB7F</b>	25 3/8"	30"	18"	—	\$1123	+\$115
		<b>IN3622.5E-PB7F</b>	25 3/8"	36"	18"	—	\$1228	+\$126
		<b>IN4222.5E-PB7F</b>	25 3/8"	42"	18"	—	\$1344	+\$137

- Worksurface supporting for 28.5" H
- Be sure to specify a 3/8" top along with spacers to achieve a 28.5" finished worksurface height
- **FLAT GLIDE ONLY** when used with Inscape Bench

	Part number	H	W	D	Wt (lbs)	Neutral paint/ base price	Accent paint	
	Inscape Bench Bookcase Flat Glides	<b>IN3022.5-1BK18</b>	25 3/8"	30"	18"	—	\$1065	+\$108
		<b>IN3622.5-1BK18</b>	25 3/8"	36"	18"	—	\$1115	+\$114
		<b>IN4222.5-1BK18</b>	25 3/8"	42"	18"	—	\$1183	+\$121

- See Inscape Bench Application Guide for bracket details & locations
- Twin-Bin brackets are quoted separately and are specific to panel thickness
- Twin-Bin cannot be installed directly above a worksurface as it causes interference
- Jumper cables and receptacles for the Electrified Twin Bin power track specified separately
- The “IN3D\_UD-8” receptacles are to be specified in conjunction with the Electrified Twin-Bin
- See Inscape System Application Guide for bracket details and locations
- Twin-Bin brackets are specific to frame thickness
- “2F” denotes use with 2.75" thick frame
- Brackets are for use with Bench stack-on frames only

	Part number	H	W	Wt (lbs)	Nuform classic/ neutral paint/ base price	Nuform select	Accent paint	
	Nuform Front Twin-Bin	<b>INTWQB36LH</b>	14"	36"	42	\$1449	+\$161	+\$146
		<b>INTWQB42LH</b>	14"	42"	52	\$1506	+\$167	+\$153
		<b>INTWQB48LH</b>	14"	48"	58	\$1558	+\$172	+\$159
		<b>INTWQB54LH</b>	14"	54"	62	\$1576	+\$174	+\$161
		<b>INTWQB60LH</b>	14"	60"	68	\$1593	+\$177	+\$162
	Nuform Front Electrified Twin-Bin	<b>INETWBQ36</b>	14"	36"	42	\$1886	+\$209	+\$191
		<b>INETWBQ42</b>	14"	42"	52	\$1975	+\$219	+\$200
		<b>INETWBQ48</b>	14"	48"	58	\$2024	+\$225	+\$205
		<b>INETWBQ54</b>	14"	54"	62	\$2048	+\$227	+\$207
		<b>INETWBQ60</b>	14"	60"	68	\$2071	+\$229	+\$209

	Part number	W	List price	
	Twin-Bin Bracket for install on a 20.25" H Stack-on	<b>INTWBKTUH-36-2F</b>	36"	\$178
		<b>INTWBKTUH-42-2F</b>	42"	\$180
		<b>INTWBKTUH-48-2F</b>	48"	\$183
		<b>INTWBKTUH-54-2F</b>	54"	\$185
		<b>INTWBKTUH-60-2F</b>	60"	\$188
	Twin-Bin Bracket for install on a 27" H Stack-on	<b>INTWBKT-U</b>	—	\$114

- Electrified Twin Bin shelf is installed in opening where electrical is located (center)
- Electrified Twin Bin Whiteboard + Tackboard only compatible with Electrified Twin Bin
- Receptacles are available in color options of black (default), white and gray
- White close match to 168 Glacier White and Gray close match to 290 – Aluminum Leaf
- The circuit 3 receptacle requires 2+2 or 3+1 wire designation (“4” in the code signifies 3+1 compatibility)
- USB power modules can be used with the Electrified Twin-Bin

**NOTE**

Only Expo Markers are to be used on any Inscape Whiteboard. Whiteboards should be cleaned with Expo Eraser or a Microfiber cleaning cloth along with Expo Cleaning Solution which is formulated to remove residue from Expo Dry Erase Markers.

	Part number	H	W	Grade 1/ COM/ base price	Grade 2	Grade 3	Grade 4	Grade 5	Grade 6	Grade 7	Grade 8
	<b>INTWBTB-12</b>	14"	12"	\$130	+\$8	+\$16	—	+\$29	—	+\$74	—
	<b>INTWBTB-14</b>	14"	14"	\$133	+\$8	+\$16	—	+\$29	—	+\$74	—
	<b>INTWBTB-16</b>	14"	16"	\$139	+\$8	+\$16	—	+\$29	—	+\$74	—
	<b>INTWBTB-18</b>	14"	18"	\$145	+\$8	+\$16	—	+\$29	—	+\$74	—
	<b>INTWBTB-20</b>	14"	20"	\$159	+\$8	+\$16	—	+\$29	—	+\$74	—

Electrified Twin-Bin Tackboard

	Part number	H	W	Wt (lbs)	Base price	Accent paint
	<b>INETWBSHF-12</b>	—	12"	—	\$105	+\$13
	<b>INETWBSHF-14</b>	—	14"	—	\$105	+\$13
	<b>INETWBSHF-16</b>	—	16"	—	\$105	+\$13
	<b>INETWBSHF-18</b>	—	18"	—	\$105	+\$13
	<b>INETWBSHF-20</b>	—	20"	—	\$105	+\$13

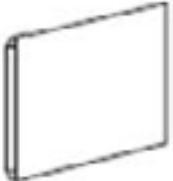
	<b>INTWBWB-12</b>	14"	12"	—	\$39	—
	<b>INTWBWB-14</b>	14"	14"	—	\$39	—
	<b>INTWBWB-16</b>	14"	16"	—	\$39	—
	<b>INTWBWB-18</b>	14"	18"	—	\$45	—
	<b>INTWBWB-20</b>	14"	20"	—	\$45	—

	<b>INETPTWB-8</b>	—	8"	—	\$88	—
---	-------------------	---	----	---	------	---

	Part number	Black/ baseprice	White	Gray
	<b>IN3D1-UD-8</b>	\$27	+\$11	+\$11
	<b>IN3D2-UD-8</b>	\$27	+\$11	+\$11
	<b>IN3D3-UD-8</b>	\$27	+\$11	+\$11
	<b>IN3D3U-UD-8</b>	\$27	+\$11	+\$11
	<b>IN3D4-UD-8</b>	\$27	+\$11	+\$11

# Bench Accessories

**inscape**

work for tomorrow

Spine Accessories are units that may be specified to sit on top of any of the benching spines. The units are specified to include the stanchion kit or not (see notes on page). Height Adjustable worksurfaces must not be specified when spine accessories are specified due to interference with the lift mechanism. The only exception to this is Add on Glazing.

### ADD-ON GLAZING

Add-on Glazing is manufactured from ¼" tempered glass. A ⅜" tempered glass is also available. Glazing may be mounted to the top of any equivalent Inscape Bench spine or combination of bases outlined in the Application Guide. Glazing is available in clear, gray, etched one or two sides and designer glass Strie options. Add-on Glazing includes top trim, glass mounting extrusion and specified glass. Add-on Glazing is specified based on the thickness of the panel. **Note: Special Hi-lo Add-on Glazing must be specified when installed directly adjacent to a higher panel at an inline situation only.** The glaze and extrusion are inset on one side to allow for hi-lo vertical trim on the adjacent higher panel. If the situation calls for hi-lo on both sides, a special may be required. An Add on Glazing alignment clip is included with each Add on Glaze ordered in the ¼" thickness option.

### TRANSACTION TOPS

Transaction Tops are specific to spine width they are to be installed on. Stanchions and top trim are included in the kit, as well as a 1" thick Nuform or laminate top. Hi-Lo Transaction Top must be specified when a transaction top is specified directly adjacent to a higher panel. The worksurface takes into account the profile of the end trim.

On the Inset Transaction Top, the worksurface is inset 5" on each side from the ends of the top cap.

**NOTE: 72", 84" and 96" W kits consist of two top caps and four stanchions (based on "Symmetrical Frame Configuration" module lines). Top Caps can be specified as an option and are included with the kit.**

### UP-MOUNT BIN

The Up-mount Bin is constructed of 24 gauge steel on the back and 20 gauge steel on bottom, sides and top. The Up-mount Bin is ordered and shipped independent of the stanchion kit, top trim and accessories to hang on back of bin. The stanchion kit includes hardware to mount the stanchions on the crossrail of the frame and top trim (tapered or flat). Stanchion kits are specified based on thickness of frame in which the Up-mount Bin is being installed. The backs of all Up-mount Bins require either a whiteboard or a tackboard to provide a clean aesthetic. These accessories are specific to the Up-mount Bin and include mounting hardware. The stanchion and Up-mount Bin provide an overall height of 20.25" module matching adjacent panel heights. The bin is 12.75" deep and may be specified directly adjacent to another Up-mount Bin facing the opposite direction; creating a "Twin-Bin" effect. Separate top cap and two stanchions will be required for each bin.

### OPEN LEG ACCESSORIES

Open Leg Accessories are units which hang from the Open H Leg, O Leg or A Leg on the Inscape Bench. Most of these units are constructed of laminate and come complete with all brackets to hang. With the exception of the Worksurface Extension which is not compatible with height adjustable worksurfaces, these units may be specified when a Height Adjustable worksurface is being used. The units sit 2" lower than the worksurface so there is no concern of pinch points when lowering the worksurface. The weight capacity of shelves is 100 lbs and all other units are 200 lbs. The HipStach is a painted unit and is available in any of Inscape's standard colors.

### SPINE DIVIDERS

Spine Dividers are situated on top of the bench spine only – full height or partial. They come complete with brackets and hardware to mount on the frame as well as a top cap. Dividers may span over two frame (see application guide). The tackable version is for tackability only. The two heights of divider match overall A.F.F heights of 37" and 44". Tackable Spine Divider is a 1.125" thick fabric wrapped panel.

### WORKSURFACE DIVIDER

Worksurface Divider may only be used with Bench as the depth correlates with the worksurface depth of the benching surfaces. All hardware is included to mount the divider on the worksurface. It does not deface the worksurface and can be used with either 1" or 1 ¼" thick surfaces. Spine Divider Accessories have a slightly different aesthetic as Inscape System paper accessories. Accessories cannot hang on the tackboard spine divider.

**WORKSURFACE MOUNTED  
CORNER SCREENS**

Worksurface mounted corner screens mount to main surface to provide privacy for the user. All worksurface mounted corner screens are handed left or right. The handedness is determined from the user perspective (i.e. a left handed screen would install on the left hand side of the user). The overall screen height is half way between a 44" H and a 51" H frame; 3.37" above the 44" frame height. Screens are available in two types; curved wood and metal. Screens have an optional feature for a tackable fabric "skin" on the inside.

Metal worksurface mounted corner screens can be painted any of the standard color. The optional fabric skin on a metal screen is only on the interior back. Only metal worksurface mounted corner screens are compatible with freestanding height adjustable worksurfaces.

**UPMOUNT SHELF**

Upmount shelves have a transaction top style shelf with a wrap around screen. Upmount shelves can be use with either parallel or 90° worksurface applications. The overall height is half way between a 44" H and a 51" H frame when mounted on a Bench spine frame (3.37" above the 44" frame height) and matches the overall height of a Worksurface Mounted Corner Screen. The shelf can be optioned in Nuform and laminate. The screens are available in metal. Screens have an optional feature for a tackable fabric "skin" on the inside.

The metal screens on the upmont shelves can be painted any of the standard color. The optional fabric skin on a metal screen is only on the interior back.

Back to back metal upmount shelves are handed left or right. The handedness is determined from the user perspective (i.e. a left handed screen would be open on the left hand side when user is looking at the spine).

- Planter box include painted rectangular stanchions kits and trim for spine mount
- 72" (36" top caps) wide kits consist of two top caps and four stanchions
- Flat trim profile only
- On-module installation only
- Planter box is available in both laminate and metal construction
- Planter box is not available with plywood edge band

**NOTES**

In order to get a total cost on products when upcharges are present take the list price of the product number and add the upcharge cost shown to the list price.

For example:

Product INBPLNTTOP-36 in Grade 1 Laminate would be \$2206 +\$708

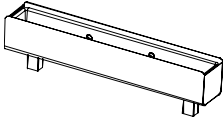
		Part number	H	W	D	Neutral paint/ base price	Accent paint
	Planter Box, Metal	<b>INBMLNTTOP30</b>	5 ¼"	30"	4 ½"	\$539	+\$56
		<b>INBMLNTTOP36</b>	5 ¼"	36"	4 ½"	\$574	+\$59
		<b>INBMLNTTOP48</b>	5 ¼"	48"	4 ½"	\$748	+\$77
		<b>INBMLNTTOP60</b>	5 ¼"	60"	4 ½"	\$805	+\$83

		Part number	H	W	D	Laminate/ base price	Grade 1 laminate	Accent paint
	Planter Box, Laminate	<b>INBPLNTTOP-36</b>	6"	36"	6"	\$2206	+\$708	+\$222
		<b>INBPLNTTOP-42</b>	6"	42"	6"	\$2337	+\$750	+\$237
		<b>INBPLNTTOP-48</b>	6"	48"	6"	\$2465	+\$790	+\$249
		<b>INBPLNTTOP-60</b>	6"	60"	6"	\$2594	+\$832	+\$262





- Transaction Tops include painted rectangular stanchions kits and trim for spine mount
- 72" (36" top caps) wide kits consist of two top caps and four stanchions
- Transaction Top is available in 1" Nuform or Laminate
- On the Inset Transaction Top, the worksurface is inset 5" on each side from the ends of the top cap
- Flat trim profile only
- On-module installation only

**NOTES**

In order to get a total cost on products when upcharges are present take the list price of the product number and add the upcharge cost shown to the list price.

For example:





Product INBTRANTOP-36 in Grade 1 Laminate would be \$426 ++\$142

	Part number	H	W	D	Nuform classic/ laminate/ base price	Nuform select	Grade 1 laminate	Grade 2 laminate	Accent paint
 Transaction Top	<b>INBTRANTOP-36</b>	6 5/16"	36"	12"	\$426	+\$23	+\$142	+\$283	+\$46
	<b>INBTRANTOP-42</b>	6 5/16"	42"	12"	\$451	+\$25	+\$139	+\$276	+\$48
	<b>INBTRANTOP-48</b>	6 5/16"	48"	12"	\$486	+\$27	+\$148	+\$296	+\$51
	<b>INBTRANTOP-54</b>	6 5/16"	54"	12"	\$511	+\$29	+\$157	+\$312	+\$53
	<b>INBTRANTOP-60</b>	6 5/16"	60"	12"	\$517	+\$29	+\$161	+\$319	+\$54
	<b>INBTRANTOP-72</b>	6 5/16"	72"	12"	\$848	+\$45	+\$262	+\$519	+\$88
 Inset Transaction Top	<b>INBACTRTOP-36</b>	6 5/16"	36"	12"	\$451	+\$23	+\$142	+\$283	+\$48
	<b>INBACTRTOP-42</b>	6 5/16"	42"	12"	\$463	+\$25	+\$139	+\$276	+\$49
	<b>INBACTRTOP-48</b>	6 5/16"	48"	12"	\$486	+\$27	+\$148	+\$296	+\$51
	<b>INBACTRTOP-54</b>	6 5/16"	54"	12"	\$511	+\$29	+\$157	+\$312	+\$53
	<b>INBACTRTOP-60</b>	6 5/16"	60"	12"	\$517	+\$29	+\$161	+\$319	+\$54
	<b>INBACTRTOP-72</b>	6 5/16"	72"	12"	\$848	+\$45	+\$262	+\$519	+\$88

- Up-mount overhead bins MUST always be specified to include a tackboard or whiteboard
- Up-mount bins stanchions must be specified to support a frame mounted up-mount bin
- “INB” Stanchion Kit must be used with Inscape Bench only
- Top caps included with stanchion kits and are specified to match frame and bin width
- Optional colored insert and shelf available for Up-Mount bin only
- Up-Mount shelf mounts below the Up-Mount Bin on module
- Stanchions are specific to the Bench frame and can not be used with Inscape System

**NOTE**

Only Expo Markers are to be used on any Inscape Whiteboard. Whiteboards should be cleaned with Expo Eraser or a Microfiber cleaning cloth along with Expo Cleaning Solution which is formulated to remove residue from Expo Dry Erase Markers.

	Part number	H	W	D	Neutral paint/ base price	Accent paint	
	Up-Mount Bin	<b>INPHUMB30</b>	14"	30"	—	\$657	+\$67
		<b>INPHUMB36</b>	14"	36"	—	\$677	+\$69
		<b>INPHUMB42</b>	14"	42"	—	\$709	+\$72
		<b>INPHUMB48</b>	14"	48"	—	\$724	+\$74
		<b>INPHUMB54</b>	14"	54"	—	\$755	+\$77
		<b>INPHUMB60</b>	14"	60"	—	\$829	+\$87
	Stanchion Kit for Up-Mount Bins For use with Bench spine frames	<b>INBUSKT30-2F</b>	13 1/2"	30"	2 3/4"	\$657	+\$67
		<b>INBUSKT36-2F</b>	13 1/2"	36"	2 3/4"	\$677	+\$69
		<b>INBUSKT42-2F</b>	13 1/2"	42"	2 3/4"	\$709	+\$72
		<b>INBUSKT48-2F</b>	13 1/2"	48"	2 3/4"	\$724	+\$74
		<b>INBUSKT54-2F</b>	13 1/2"	54"	2 3/4"	\$755	+\$77
		<b>INBUSKT60-2F</b>	13 1/2"	60"	2 3/4"	\$829	+\$87
	Colored Insert for back of bin For Up-Mounted bin only	<b>IN12INSRT30</b>	12 1/8"	30"	—	\$108	+\$15
		<b>IN12INSRT36</b>	12 1/8"	36"	—	\$116	+\$15
		<b>IN12INSRT42</b>	12 1/8"	42"	—	\$121	+\$16
		<b>IN12INSRT48</b>	12 1/8"	48"	—	\$128	+\$16
	Up-Mount Bin Whiteboard	<b>INUBWHB1430</b>	14"	30"	—	\$48	—
		<b>INUBWHB1436</b>	14"	36"	—	\$52	—
		<b>INUBWHB1442</b>	14"	42"	—	\$59	—
		<b>INUBWHB1448</b>	14"	48"	—	\$65	—
		<b>INUBWHB1454</b>	14"	54"	—	\$74	—
		<b>INUBWHB1460</b>	14"	60"	—	\$77	—

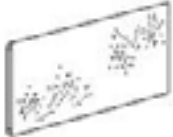
	Part number	H	W	Grade 1/ COM/ base price	Grade 2	Grade 3	Grade 4	Grade 5	Grade 6	Grade 7	Grade 8	
	Up-Mount Bin Tackboard	<b>INUBTAC1430</b>	14"	30"	\$195	+\$7	+\$12	—	+\$29	—	+\$77	—
		<b>INUBTAC1436</b>	14"	36"	\$198	+\$12	+\$22	—	+\$44	—	+\$103	—
		<b>INUBTAC1442</b>	14"	42"	\$204	+\$13	+\$23	—	+\$45	—	+\$106	—
		<b>INUBTAC1448</b>	14"	48"	\$209	+\$13	+\$23	—	+\$48	—	+\$115	—
		<b>INUBTAC1454</b>	14"	54"	\$212	+\$12	+\$25	—	+\$47	—	+\$114	—
		<b>INUBTAC1460</b>	14"	60"	\$219	+\$10	+\$22	—	+\$46	—	+\$114	—

- 3/8" top is installation ready, complete with double sided tape for adhesion to case
- Sliding door must be mounted on two up-mount bins of equal size that are side by side

	Part number	W	D	Nuform classic/ base price	Nuform select
	3/8" T Up-Mount Bin Top				
	<b>PHUMBTOP-1330</b>	30"	13"	\$187	+\$20
	<b>PHUMBTOP-1336</b>	36"	13"	\$221	+\$17
	<b>PHUMBTOP-1342</b>	42"	13"	\$245	+\$27
	<b>PHUMBTOP-1348</b>	48"	13"	\$272	+\$30
	<b>PHUMBTOP-1354</b>	54"	13"	\$299	+\$31
	<b>PHUMBTOP-1360</b>	60"	13"	\$327	+\$34
	<b>PHUMBTOP-1372</b>	72"	13"	\$429	+\$45
	<b>PHUMBTOP-1384</b>	84"	13"	\$479	+\$48
<b>PHUMBTOP-1396</b>	96"	13"	\$526	+\$54	

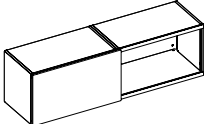
	Part number	W	Nuform classic/ laminated/ base price	Nuform select	Grade 1 laminated
	Sliding Door & Track Up-Mount bin specified separately				
	<b>INUMBSLDR30</b>	30"	\$564	+\$63	+\$182
	<b>INUMBSLDR36</b>	36"	\$580	+\$65	+\$187
	<b>INUMBSLDR42</b>	42"	\$589	+\$66	+\$191
<b>INUMBSLDR48</b>	48"	\$605	+\$67	+\$196	

- For use with Inscape Bench only
- Screens and shelves (both metal and wood) have an OPTIONAL feature for a tackable fabric "skin" on the inside. Base price is without skin
- The fabric skin on the wood screens wraps all the way around the interior of the screen. On metal screens it is only on interior back
- Wood upmount shelf screens are finished in a clear coat on maple
- Wood upmount shelves and screens have a 5.5" curved corner while metal upmount shelves and screens have a 1" corner
- Metal upmount shelf screens can be painted in all standard colors
- Back to back metal upmount shelves are handed left or right. The handedness is determined from the user perspective (i.e. a left handed screen would be open on the left hand side when user is looking at the spine)

- Upmount shelves can be use with either parallel or 90° worksurface applications; however, they can NOT be used on fully freestanding straight applications. Even one where docking brackets are used
- 72" sizes come with a 72" top cap

**NOTES**

In order to get a total cost on products when upcharges are present take the list price of the product number and add the upcharge cost shown to the list price.

For example:

Product INBUPSHELFM-36 with a Grade D fabric skin and a Grade 1 laminate shelf would be \$941 +\$0 +\$62 +\$142

Part number	H	W	D	List/ base price	Fabric skin options							Accent paint
					No fabric layer	Grade A/COM	Grade B	Grade C	Grade D	Grade E	Grade F	
 <b>INBUPSHELFM-36</b> For use with a 36" w spine frame	14.062"	26"	9 ½"	\$941	-\$156	+\$0	+\$43	+\$52	+\$62	+\$69	+\$81	+\$97
<b>INBUPSHELFM-60</b> For use with a 60" w spine frame	14.062"	50"	9 ½"	\$1115	-\$175	+\$0	+\$43	+\$52	+\$62	+\$69	+\$81	+\$114
<b>INBUPSHELFM-72</b> For use with a 72" w (2x 36") spine frame	14.062"	62"	9 ½"	\$1298	-\$206	+\$0	+\$59	+\$74	+\$92	+\$102	+\$116	+\$132

Single Metal  
Upmount Shelf

**Shelf finish options**

Product number	Nuform classic/laminate	Nuform select	Grade 1 laminate	Grade 2 lamainte
<b>INBUPSHELFM-36</b>	+\$0	+\$23	+\$142	+\$283
<b>INBUPSHELFM-60</b>	+\$0	+\$29	+\$161	+\$319
<b>INBUPSHELFM-72</b>	+\$0	+\$45	+\$262	+\$519

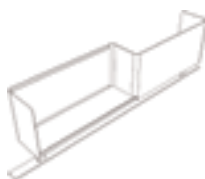

Back to Back Metal  
Upmount Shelf

<b>INBUPSHELFM72LH</b> For use with a 72" w (2x 36") spine frame left handed (illustrated)	14 ⅞"	62"	9 ½"	\$1281	-\$164	+\$0	+\$31	+\$39	+\$48	+\$53	+\$60	+\$130
<b>INBUPSHELFM72RH</b> For use with a 72" w (2x 36") spine frame right handed	14 ⅞"	62"	9 ½"	\$1281	-\$164	+\$0	+\$31	+\$39	+\$48	+\$53	+\$60	+\$130

**Shelf finish options**

Product number	Nuform classic/laminate	Nuform select	Grade 1 laminate	Grade 2 lamainte
<b>INBUPSHELFM72LH</b>	+\$0	+\$45	+\$283	+\$565
<b>INBUPSHELFM72RH</b>	+\$0	+\$45	+\$283	+\$565

- Add-on Glazing comes complete with mounting hardware and top cap
- Add-on Glazing may span multiple frames according to guidelines set in the Inscape Bench Application Guide
- 10.125" thick glaze available in .25" thick
- One glaze Alignment clip is included with each Add-on Glazing
- Add-on Glazing up to 60" W require two additional Jesters to be specified if spanning multiple frames (i.e. a 60" W AOG installed on 2-30" frames)
- **List/Base for 0.25" thick is clear glass**



**NOTES**

In order to get a total cost on products when upcharges are present take the list price of the product number and add the upcharge cost shown to the list price.

For example:

Product INAG6.7530-2F 0.25" thick glass with Gray would be \$225 +\$108

The same product upgraded to 0.38" thick glass would be \$225 +\$112 +\$273

Part number	W	List/base / 0.25" thick glazing price	Glazing thickness option	0.25" thick finish options				0.38" thick finish options			Accent paint	
			0.38" thick glazing	Clear	Gray	Etched 1 side	Etched 2 side	Clear	Gray	Etched 1 side		
 6.75" H Add-On Glazing For use with 2 3/4" T frames	<b>INAG6.7530-2F</b>	30"	\$225	+\$112	+\$0	+\$108	+\$108	+\$213	+\$0	+\$273	+\$273	+\$25
	<b>INAG6.7536-2F</b>	36"	\$248	+\$124	+\$0	+\$119	+\$119	+\$260	+\$0	+\$295	+\$295	+\$27
	<b>INAG6.7542-2F</b>	42"	\$265	+\$132	+\$0	+\$124	+\$124	+\$270	+\$0	+\$312	+\$312	+\$29
	<b>INAG6.7548-2F</b>	48"	\$286	+\$140	+\$0	+\$128	+\$128	+\$276	+\$0	+\$329	+\$329	+\$31
	<b>INAG6.7554-2F</b>	54"	\$305	+\$152	+\$0	+\$131	+\$131	+\$280	+\$0	+\$343	+\$343	+\$33
	<b>INAG6.7560-2F</b>	60"	\$329	+\$164	+\$0	+\$144	+\$144	+\$310	+\$0	+\$376	+\$376	+\$35
	<b>INAG6.7566-2F</b>	66"	\$341	+\$168	+\$0	+\$179	+\$179	+\$336	+\$0	+\$434	+\$434	+\$36
	<b>INAG6.7572-2F</b>	72"	\$358	+\$178	+\$0	+\$199	+\$199	+\$368	+\$0	+\$471	+\$471	+\$37
	<b>INAG6.7578-2F</b>	78"	\$456	+\$223	+\$0	+\$154	+\$154	+\$316	+\$0	+\$453	+\$453	+\$49
	<b>INAG6.7584-2F</b>	84"	\$533	+\$263	+\$0	+\$129	+\$129	+\$282	+\$0	+\$453	+\$453	+\$56
<b>INAG6.7590-2F</b>	90"	\$611	+\$302	+\$0	+\$102	+\$102	+\$250	+\$0	+\$453	+\$453	+\$63	
<b>INAG6.7596-2F</b>	96"	\$688	+\$340	+\$0	+\$77	+\$77	+\$218	+\$0	+\$453	+\$453	+\$71	
 10.125" H Add-On Glazing For use with 2 3/4" T frames	<b>INAG10.12530-2F</b>	30"	\$226	+\$133	+\$0	+\$111	+\$111	+\$214	+\$0	+\$204	+\$204	+\$25
	<b>INAG10.12536-2F</b>	36"	\$252	+\$135	+\$0	+\$127	+\$127	+\$259	+\$0	+\$207	+\$207	+\$27
	<b>INAG10.12542-2F</b>	42"	\$277	+\$139	+\$0	+\$138	+\$138	+\$285	+\$0	+\$210	+\$210	+\$30
	<b>INAG10.12548-2F</b>	48"	\$301	+\$160	+\$0	+\$153	+\$153	+\$310	+\$0	+\$239	+\$239	+\$32
	<b>INAG10.12554-2F</b>	54"	\$324	+\$179	+\$0	+\$166	+\$166	+\$332	+\$0	+\$268	+\$268	+\$34
	<b>INAG10.12560-2F</b>	60"	\$353	+\$185	+\$0	+\$183	+\$183	+\$369	+\$0	+\$285	+\$285	+\$37
	<b>INAG10.12566-2F</b>	66"	\$373	+\$200	+\$0	+\$211	+\$211	+\$398	+\$0	+\$309	+\$309	+\$39
	<b>INAG10.12572-2F</b>	72"	\$415	+\$214	+\$0	+\$210	+\$210	+\$400	+\$0	+\$333	+\$333	+\$45
	<b>INAG10.12578-2F</b>	78"	\$496	+\$229	+\$0	+\$180	+\$180	+\$366	+\$0	+\$358	+\$358	+\$52
	<b>INAG10.12584-2F</b>	84"	\$569	+\$246	+\$0	+\$162	+\$162	+\$337	+\$0	+\$383	+\$383	+\$59
<b>INAG10.12590-2F</b>	90"	\$642	+\$259	+\$0	+\$138	+\$138	+\$310	+\$0	+\$408	+\$408	+\$65	
<b>INAG10.12596-2F</b>	96"	\$718	+\$274	+\$0	+\$119	+\$119	+\$283	+\$0	+\$434	+\$434	+\$73	

- Add-on Glazing comes complete with mounting hardware and top cap
- Add-on Glazing may span multiple frames according to guidelines set in the Inscape Bench Application Guide
- 10.125" thick glaze available in .25" thick
- One glaze Alignment clip is included with each Add-on Glazing
- Add-on Glazing up to 60" W require two additional Jesters to be specified if spanning multiple frames (i.e. a 60" W AOG installed on 2-30" frames)
- **List/Base for 0.25" thick is clear glass**

**NOTES**

In order to get a total cost on products when upcharges are present take the list price of the product number and add the upcharge cost shown to the list price.

For example:

Product INAG10.12530-2F 0.25" thick glass with Gray would be \$226 +\$111

The same product upgraded to 0.38" thick glass would be \$226 +\$133 +\$204

Part number	W	List/base / 0.25" thick glazing price	Glazing thickness option	0.25" thick finish options				0.38" thick finish options			Accent paint	
			0.38" thick glazing	Clear	Gray	Etched 1 side	Etched 2 side	Clear	Gray	Etched 1 side		
	<b>INAG13.530-2F</b>	30"	\$227	+\$114	+\$0	+\$112	+\$112	+\$214	+\$0	+\$277	+\$277	+\$25
	<b>INAG13.536-2F</b>	36"	\$256	+\$128	+\$0	+\$133	+\$133	+\$258	+\$0	+\$324	+\$324	+\$27
	<b>INAG13.542-2F</b>	42"	\$287	+\$142	+\$0	+\$156	+\$156	+\$301	+\$0	+\$371	+\$371	+\$31
	<b>INAG13.548-2F</b>	48"	\$317	+\$157	+\$0	+\$178	+\$178	+\$343	+\$0	+\$421	+\$421	+\$33
	<b>INAG13.554-2F</b>	54"	\$347	+\$171	+\$0	+\$199	+\$199	+\$383	+\$0	+\$465	+\$465	+\$36
	<b>INAG13.560-2F</b>	60"	\$376	+\$185	+\$0	+\$220	+\$220	+\$427	+\$0	+\$513	+\$513	+\$42
	<b>INAG13.566-2F</b>	66"	\$404	+\$200	+\$0	+\$245	+\$245	+\$459	+\$0	+\$561	+\$561	+\$44
	<b>INAG13.572-2F</b>	72"	\$470	+\$229	+\$0	+\$220	+\$220	+\$470	+\$0	+\$560	+\$560	+\$50
	<b>INAG13.578-2F</b>	78"	\$535	+\$264	+\$0	+\$208	+\$208	+\$413	+\$0	+\$571	+\$571	+\$56
	<b>INAG13.584-2F</b>	84"	\$604	+\$296	+\$0	+\$196	+\$196	+\$393	+\$0	+\$586	+\$586	+\$62
	<b>INAG13.590-2F</b>	90"	\$671	+\$331	+\$0	+\$173	+\$173	+\$371	+\$0	+\$586	+\$586	+\$69
	<b>INAG13.596-2F</b>	96"	\$739	+\$366	+\$0	+\$160	+\$160	+\$348	+\$0	+\$599	+\$599	+\$76

13.5" H Add-On Glazing  
For use with 2 3/4" T frames

- For use with Inscape Bench only
- 1.125" thick soft feel fabric wrapped tackboard panel
- Includes hardware and top cap
- Laminate divider accessories are not compatible with this panel

**NOTES**

In order to get a total cost on products when upcharges are present take the list price of the product number and add the upcharge cost shown to the list price.

For example:

Product INBAPF1636 in Grade C would be \$813 +\$280

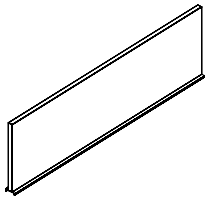

16.875" H Spine Tackable Divider  
To match 44" H Frame Height and 13.5" H Worksurface Tackable Divider

Part number	H	W	Thickness	Grade A/ base price	Grade B/ COM	Grade C	Grade D	Grade E	Grade F	Accent paint
<b>INBAPF1636</b>	16.875"	36"	1 1/8"	\$813	+\$147	+\$280	+\$366	+\$441	+\$629	+\$85
<b>INBAPF1642</b>	16.875"	42"	1 1/8"	\$867	+\$172	+\$296	+\$426	+\$512	+\$732	+\$90
<b>INBAPF1648</b>	16.875"	48"	1 1/8"	\$925	+\$167	+\$295	+\$469	+\$569	+\$818	+\$96
<b>INBAPF1660</b>	16.875"	60"	1 1/8"	\$1037	+\$273	+\$439	+\$574	+\$697	+\$1008	+\$105
<b>INBAPF1666</b>	16.875"	66"	1 1/8"	\$1120	+\$255	+\$526	+\$648	+\$787	+\$1126	+\$115
<b>INBAPF1672</b>	16.875"	72"	1 1/8"	\$1190	+\$189	+\$476	+\$610	+\$758	+\$773	+\$121
<b>INBAPF1684</b>	16.875"	84"	1 1/8"	\$1318	+\$228	+\$526	+\$683	+\$858	+\$1288	+\$134
<b>INBAPF1696</b>	16.875"	96"	1 1/8"	\$1523	+\$337	+\$624	+\$810	+\$1007	+\$1502	+\$154



16.875" H Rectangular Framed Spine Divider, Tackable  
To match 44" H Frame Height

Part number	H	W	Wt (lbs)	Grade 1/ COM/ base price	Grade 2	Grade 3	Grade 4	Grade 5	Grade 6	Grade 7	Grade 8	Accent paint
<b>INBRFD1630</b>	16.875"	30"	2 3/4"	\$764	+\$8	+\$21	+\$30	+\$39	+\$63	+\$88	+\$120	+\$79
<b>INBRFD1636</b>	16.875"	36"	2 3/4"	\$845	+\$9	+\$22	+\$33	+\$45	+\$71	+\$99	+\$137	+\$87
<b>INBRFD1642</b>	16.875"	42"	2 3/4"	\$925	+\$9	+\$16	+\$30	+\$45	+\$72	+\$101	+\$140	+\$96
<b>INBRFD1648</b>	16.875"	48"	2 3/4"	\$949	+\$11	+\$29	+\$42	+\$52	+\$86	+\$115	+\$161	+\$97
<b>INBRFD1654</b>	16.875"	54"	2 3/4"	\$1023	+\$11	+\$31	+\$46	+\$59	+\$94	+\$128	+\$177	+\$104
<b>INBRFD1660</b>	16.875"	60"	2 3/4"	\$1030	+\$13	+\$44	+\$58	+\$73	+\$108	+\$144	+\$202	+\$104

- Includes hardware and top cap
- Laminate divider accessories are not compatible with this panel
- Compatible with height adjustable worksurfaces
- 17"H screen sits 13 ½" above the worksurface and matches other spine dividers
- 21"H screen sits 16 ⅞" above the worksurface but does not align with other spine dividers or frames
- Also compatible with Inscape System
- Matches the aesthetics of the RockIt screens

**NOTES**

In order to get a total cost on products when upcharges are present take the list price of the product number and add the upcharge cost shown to the list price.



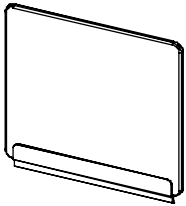

For example:

Product INBATF1636 in Grade C would be \$525 +\$80

	Part number	H	W	Thickness	Grade A/ base price	Grade B/ COM	Grade C	Grade D	Grade E	Grade F	Accent paint
 <p>Slim Fabric Tackboard Screen</p>	<b>INBATF1636</b>	17"	36"	½"	\$525	+\$56	+\$80	+\$124	—	—	+\$37
	<b>INBATF1642</b>	17"	42"	½"	\$588	+\$62	+\$90	+\$138	—	—	+\$43
	<b>INBATF1648</b>	17"	48"	½"	\$642	+\$67	+\$98	+\$151	—	—	+\$47
	<b>INBATF1654</b>	17"	54"	½"	\$718	+\$76	+\$108	+\$168	—	—	+\$52
	<b>INBATF1660</b>	17"	60"	½"	\$779	+\$83	+\$119	+\$182	—	—	+\$56
	<b>INBATF1666</b>	17"	66"	½"	\$815	+\$86	+\$124	+\$192	—	—	+\$59
	<b>INBATF1672</b>	17"	72"	½"	\$862	+\$90	+\$131	+\$201	—	—	+\$62
	<b>INBATF2036</b>	21"	36"	½"	\$604	+\$63	+\$92	+\$141	—	—	+\$44
<b>INBATF2042</b>	21"	42"	½"	\$678	+\$71	+\$103	+\$159	—	—	+\$49	
<b>INBATF2048</b>	21"	48"	½"	\$738	+\$78	+\$112	+\$172	—	—	+\$53	
<b>INBATF2054</b>	21"	54"	½"	\$826	+\$87	+\$126	+\$194	—	—	+\$59	
<b>INBATF2060</b>	21"	60"	½"	\$897	+\$94	+\$135	+\$210	—	—	+\$64	
<b>INBATF2066</b>	21"	66"	½"	\$938	+\$98	+\$142	+\$219	—	—	+\$66	
<b>INBATF2072</b>	21"	72"	½"	\$992	+\$103	+\$151	+\$232	—	—	+\$71	

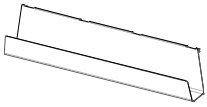

- HipStash can be hung from A Leg only and can be painted in any of Inscape's standard colors
- Lower units are hung from the Open H or O Leg
- Lower units may be specified when a Height Adjustable worksurface is installed
- Bookcases are constructed of laminate
- Accessory Hook is constructed of metal and can be painted in any of Inscape's standard colors
- Specify units based on width of the Bench
- Shelves, hook and acrylic modesty hang from the Open H or O Leg
- Laminate items are not available with plywood edge banding
- Interior dimensions for recycling and garbage doors of Lower Bookcase: 16.75"W x 12.5"H x 13.5"D

	Part number	H	W	D	Natural paint/ base price	Accent paint	
	HipStash for A Leg						
	<b>INBMASHELF48</b>	12"	48"	5"	\$591	+\$61	
	<b>INBMASHELF60</b>	12"	60"	5"	\$673	+\$69	
	Part number	H	W	D	Laminate/ base price	Grade 1 laminate	Accent paint
	Lower Bookcase with Recycling and Garbage						
	<b>INBLWRBRECY-48</b>	14.011"	51 1/3"	15"	\$4086	+\$1309	+\$412
	<b>INBLWRBRECY-60</b>	14.011"	63 1/3"	15"	\$4409	+\$1413	+\$442
	Lower Bookcase						
	<b>INBLWRBOOK-48</b>	14.011"	51 1/3"	15"	\$3761	+\$1205	+\$378
	<b>INBLWRBOOK-60</b>	14.011"	63 1/3"	15"	\$4150	+\$1329	+\$417
	Planter Box						
	<b>INBPLNTEND-48</b>	6"	51 1/3"	6"	\$2465	+\$790	+\$249
	<b>INBPLNTEND-60</b>	6"	63 1/3"	6"	\$2725	+\$873	+\$276
	Open Leg Accessory Hook				\$73	—	+\$11

- Worksurface Extension are mounted to the surface and may not be specified when a Height Adjustable worksurface is installed
- Woodgrain pattern when applied on Worksurface Extension will run perpendicularly to main worksurfaces
- Worksurface Extension only to be used with Open H and O Leg end support
- Shelves, hooks hang from the Open H or O Leg; however acrylic modesty is sized to fit H Leg only
- Acrylic modesty and privacy screens may be specified when a Height Adjustable worksurface is installed
- Acrylic modesty and privacy screens can be used with both H Legs and O Legs (when no glazed insert is optioned)

- Acrylic Privacy Screens have 14" of the screen mounted above the surface
- Acrylic Privacy/Modesty Screens have 14" of the screen mounted above the surface and 16.5" below
- Acrylic - white and frosted one side only

**NOTES**

In order to get a total cost on products when upcharges are present take the list price of the product number and add the upcharge cost shown to the list price.

For example:

Product INBWX1848 in Grade 2 Laminate would be \$573 +\$486

	Part number	H	D	Straight edge nuform classic/ laminate/ base price	Nuform select	Nuform tapered edge	Grade 1 laminate	Grade 2 laminate	Accent paint
	<b>INBWX1848</b>	51 1/3"	18"	\$573	+\$47	+\$23	+\$184	+\$486	+\$60
	<b>INBWX1860</b>	63 1/3"	18"	\$650	+\$57	+\$31	+\$210	+\$504	+\$66

Worksurface  
Extension

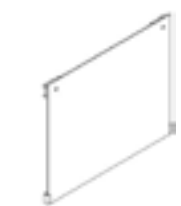
	Part number	H	W	White/ base price	Frosted	Accent paint	
	Arylic Modesty Panel for use with H Leg only	<b>INBAMP-24</b>	24 1/6"	22 4/5"	\$495	+\$495	+\$52
		<b>INBAMP-30</b>	24 1/6"	28 4/5"	\$579	+\$579	+\$60

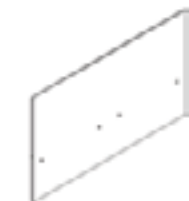
	Arylic Privacy Screen For privacy Matches 44" H overall	<b>INBAPS-1948</b>	18 5/8"	50 3/4"	\$740	+\$740	+\$76
		<b>INBAPS-1960</b>	18 5/8"	62 3/4"	\$828	+\$828	+\$86

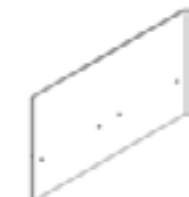
	Arylic Privacy Screen For modesty and privacy Matches 44" H overall	<b>INBAPS-2948</b>	28 3/4"	50 3/4"	\$937	+\$937	+\$97
		<b>INBAPS-2960</b>	28 3/4"	62 3/4"	\$983	+\$983	+\$101

- For use with Inscape Bench only
- Tackable divider is a 1.125" thick fabric wrapped tackboard panel
- Laminate divider accessories are not compatible with tackable divider
- Divider Screen for straight edge worksurfaces are available in a mid or end application option
- The end application Divider Screen can also be used on a height adjustable worksurfaces
- Divider Screen specific to tapered edge worksurfaces is 2" shorter then width stated to accommodate tapered edge and is easier to move
- Dividers Include hardware to mount to the worksurface perpendicular to spine

**NOTES**

In order to get a total cost on products when upcharges are present take the list price of the product number and add the upcharge cost shown to the list price.

For example:

Product INBSPDF1324 in Grade C would be \$563 +\$208

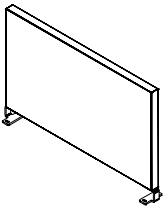
	Part number	H	W	Thickness	Grade A/ base price	Grade B/ COM	Grade C	Grade D	Grade E	Grade F	Accent paint
	<b>INBSPDF1324</b>	13.5"	24"	1 1/8"	\$563	+\$126	+\$208	+\$289	+\$341	+\$467	+\$59
	<b>INBSPDF1330</b>	13.5"	30"	1 1/8"	\$620	+\$129	+\$259	+\$336	+\$399	+\$556	+\$64

13.5" H Worksurface  
Tackable Divider for Mid  
Application  
With mounting brackets on  
front and back  
For use with straight edge  
worksurfaces  
Matches 44" H panel and  
16.875" H Spine Tackable  
Divider

	<b>INBSPDFED1324</b>	13.5"	24"	1 1/8"	\$563	+\$126	+\$208	+\$289	+\$341	+\$467	+\$59
	<b>INBSPDFED1330</b>	13.5"	30"	1 1/8"	\$620	+\$129	+\$259	+\$336	+\$399	+\$556	+\$64

13.5" H Worksurface  
Tackable Divider for End  
Application  
With mounting brackets on  
front and back  
For use with straight edge  
worksurfaces  
Matches 44" H panel and  
16.875" H Spine Tackable  
Divider

- For use with Inscape Bench only
- Tackable divider is a 1.125" thick fabric wrapped tackboard panel
- Laminate divider accessories are not compatible with tackable divider
- Dividers Include hardware to mount to the worksurface perpendicular to spine
- Divider Screen for straight edge worksurfaces are available in a mid or end application option
- The end application Divider Screen can also be used on a height adjustable worksurfaces
- Divider Screen specific to tapered edge worksurfaces is 2" shorter then width stated to accommodate tapered edge and is easier to move

**NOTES**

In order to get a total cost on products when upcharges are present take the list price of the product number and add the upcharge cost shown to the list price.

For example:

Product INBDSDF1324 in Grade C would be \$519 +\$204

Part number	H	W	Thickness	Grade A/ base price	Grade B/ COM	Grade C	Grade D	Grade E	Grade F	Accent paint
<b>INBDSDF1324</b>	13.5"	24"	1 1/8"	\$519	+\$142	+\$204	+\$296	+\$345	+\$462	+\$54
<b>INBDSDF1330</b>	13.5"	30"	1 1/8"	\$588	+\$139	+\$273	+\$332	+\$393	+\$539	+\$61

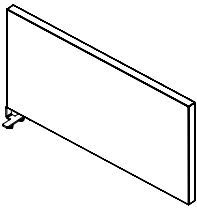

13.5" H Worksurface  
Tackable Divider  
With single bracket to be  
mount at back of surface only  
For use with tapered edge  
worksurfaces  
Matches 44" H panel and  
16.875" H Spine Tackable  
Divider

- Accessories do not hang on the tackable version of the dividers
- Slightly different design detail from Inscape System paper trays

**NOTES**

In order to get a total cost on products when upcharges are present take the list price of the product number and add the upcharge cost shown to the list price.

For example:

Product INBAPTRY in an accent paint would be \$85 +\$11

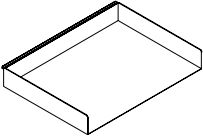
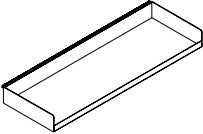
		Part number	H	W	D	Neutral paint/ base price	Accent paint
	Paper Tray No holes in bottom	<b>INBAPTRY</b>	2"	12"	9"	\$85	+\$11
	Personal Accessory Tray	<b>INBAPSHF</b>	2"	18"	6"	\$126	+\$16

## Accessories

### Worksurface Screens for 90° Workstations

- For use with 90° worksurface applications only
- Screens and shelves (both metal and wood) have an OPTIONAL feature for a tackable fabric "skin" on the inside. Base price is without skin
- The fabric skin on the metal screens is only on the interior back of the screen.
- All Worksurface Mounted Corner Screens have 16 7/8" above the worksurface. The curved metal screen is 6" below the surface
- Worksurface Mounted Corner Metal Screens can be painted in all of Inscape's standard colors
- All Worksurface Mounted Corner Screens are handed left or right. The handedness is determined from the user perspective (i.e. a left handed screen would install on the left hand side of the user)
- ONLY metal Worksurface Mounted Corner Screens are compatible with freestanding height adjustable worksurfaces
- There will be a 1" wire management gap between the screen and the back side of the worksurface

### NOTES

In order to get a total cost on products when upcharges are present take the list price of the product number and add the upcharge cost shown to the list price.

For example:

Product INBWMCSWLH with a Grade D fabric skin would be \$1115 +\$123



Worksurface Mounted Corner Metal Screen  
For use with straight 90° worksurfaces

Part number	H	W	D	Screen list/base price	Fabric options							Accent paint
					No fabric layer	Grade A/COM	Grade B	Grade C	Grade D	Grade E	Grade F	
<b>INBWMCSMLH</b> left handed (illustrated)	24"	41"	17"	\$660	-\$199	—	+\$79	+\$101	+\$123	+\$137	+\$156	+\$67
<b>INBWMCSMRH</b> right handed	24"	41"	17"	\$660	-\$199	—	+\$79	+\$101	+\$123	+\$137	+\$156	+\$67

## Accessories

Worksurface Screens for 90° Workstations

- Slim Surface Mounted Tackable Screen is 16 7/8" above the worksurface and matches the aesthetics of the RockIt screens. It has 6" below the surface.
- Can be mounted on any 1" or 1 1/4" thick worksurface
- Can also be used with Inscape System worksurfaces, freestanding fixed tables and freestanding height adjustable tables

### NOTES

In order to get a total cost on products when upcharges are present take the list price of the product number and add the upcharge cost shown to the list price.

For example:

Product INBTMPS2536 in Grade B would be \$700 +\$73

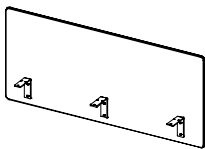

Slim Surface Mounted Tackable Screen

Part number	H	W	Thickness	Grade A/ base price	Grade B/ COM	Grade C	Grade D	Accent paint
<b>INBTMPS2536</b>	24"	36"	1/2"	\$700	+\$73	+\$106	+\$165	+\$71
<b>INBTMPS2542</b>	24"	42"	1/2"	\$786	+\$83	+\$119	+\$183	+\$80
<b>INBTMPS2548</b>	24"	48"	1/2"	\$857	+\$90	+\$130	+\$200	+\$87
<b>INBTMPS2554</b>	24"	54"	1/2"	\$957	+\$100	+\$145	+\$223	+\$97
<b>INBTMPS2560</b>	24"	60"	1/2"	\$1041	+\$108	+\$158	+\$243	+\$105

- Worksurface Undermount accessories are available in any of Inscape's standard paint colors
- Worksurface Undermount accessories can also be used on Inscape System and freestanding tables

**NOTES**

In order to get a total cost on products when upcharges are present take the list price of the product number and add the upcharge cost shown to the list price.

For example:

Product INBUMBIN in an Accent Paint would be \$235 +\$16

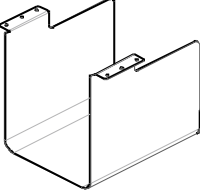
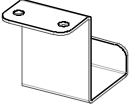
		Part number	H	W	D	Neutral paint/ base price	Accent paint
	Worksurface Undermounted Bin	<b>INBUMBIN</b>	12 1/2"	9"	12"	\$235	+\$16
	Worksurface Undermounted Accessory Hook	<b>INBUMHOOK</b>	2 1/4"	1 1/2"	1 1/2"	\$12	+\$5





- For replacement parts only

**NOTES**

In order to get a total cost on products when upcharges are present take the list price of the product number and add the upcharge cost shown to the list price.

For example:

Product INBWMCSWSKIN in Grade D would be \$221 +\$123

	Part number	H	W	Grade A/ COM/ base price	Grade B	Grade C	Grade D	Grade E	Grade F
 <p>Replacement Fabric Skin for Corner Wood Curved Screen left and right hand compatible</p>	<b>INBWMCSWSKIN</b>	16 1/8"	51 5/8"	\$221	+\$79	+\$101	+\$123	+\$137	+\$156
 <p>Replacement Fabric Skin for Corner Metal Screen left and right hand compatible</p>	<b>INBWMCSMSKIN</b>	16 1/8"	39 1/3"	\$199	+\$79	+\$101	+\$123	+\$137	+\$156



• For replacement parts only

**NOTES**

In order to get a total cost on products when upcharges are present take the list price of the product number and add the upcharge cost shown to the list price.

For example:

Product INBSHELFWSKIN36 in Grade D would be \$179 +\$62

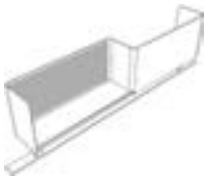
	Part number	H	W	Grade A/ COM/ base price	Grade B	Grade C	Grade D	Grade E	Grade F
 <p>Replacement Fabric Skin for Single Wood Upmount Shelf</p>	<b>INBSHELFWSKIN36</b> When shelf is used on a 36" w spine frame	11 1/2"	39 7/8"	\$179	+\$43	+\$52	+\$62	+\$69	+\$81
	<b>INBSHELFWSKIN60</b> When shelf is used on a 60" w spine frame	11 1/2"	63 7/8"	\$198	+\$43	+\$52	+\$62	+\$69	+\$81
 <p>Replacement Fabric Skin for Single Metal Upmount Shelf</p>	<b>INBSHELFMSKIN36</b> When shelf is used on a 36" w spine frame	11 5/8"	24 1/2"	\$156	+\$43	+\$52	+\$62	+\$69	+\$81
	<b>INBSHELFMSKIN60</b> When shelf is used on a 60" w spine frame	11 5/8"	48 1/2"	\$175	+\$43	+\$52	+\$62	+\$69	+\$81
 <p>Replacement Fabric Skin for Back to Back Metal Upmount Shelf left and right hand compatible single side replacement part</p>	<b>INBSHELFMSKIN72</b> When shelf is used on a 72" w (2x 36") spine frame	11 5/8"	60 1/2"	\$206	+\$59	+\$74	+\$92	+\$102	+\$116
	<b>INBSHELFMSK72</b> When shelf is used on a 72" w (2x 36") spine frame	11 5/8"	29 1/9"	\$164	+\$31	+\$39	+\$48	+\$53	+\$60

# Tables

# US Price List

June 2021

**inscape**

work for tomorrow

**Tables**  
Tables  
Collection

**inscape**

work for tomorrow

- Codes come complete with surfaces, legs and optional power
- Worksurfaces are 1 ¼" thick only and available in laminate, grade 1 laminate (plywood edge) and Nuform surface finishes
- When manually specifying worksurface in Laminate, add suffix "-S" to the code
- Laminate is available in straight edge only
- Nuform is available in straight or tapered edge
- Legs are angled and conical shaped with black leveling glides
- Legs are available in Clear Oak (default), Black Oak and Clear Maple finishes
- Standing Height Tables include a foot rail that is available in all standard paint colors. Accent paint colors have an upcharge.



- The Mini Tap power module has a 72" long cord and is available in black only. Module has 1 power + 1 USB.
- O Legs and foot rails are available in all standard paint colors. Accent paint colors have an upcharge.

**NOTES**

In order to get a total cost on products when an upcharge or downcharge is present you take the list price of the product number and add the upcharge or deduct the downcharge cost shown to the list price.

For example:

Product TCRSTA3060 in Nuform Select with a Tapered Edge and 2 power modules would be \$2503 +\$70 +\$36 +\$724

	Part number	H	W	D	Thickness	Straight edge Nuform classic/ laminate (base)	Nuform select	Nuform tapered edge	Grade 1 laminate Straight Edge only	Power options			Accent paint
										None	1 module	2 module	
 Curved Rectangular Standing Height Table available with Mini Tap power option	<b>TCRSTA3060</b>	39"	60"	30"	1 ¼"	\$2503	+\$70	+\$36	+\$214	—	+\$370	+\$724	+\$252
	<b>TCRSTA3072</b>	39"	72"	30"	1 ¼"	\$2564	+\$85	+\$60	+\$254	—	+\$370	+\$724	+\$259
	<b>TCRSTA3660</b>	39"	60"	36"	1 ¼"	\$2695	+\$84	+\$118	+\$268	—	+\$370	+\$724	+\$273
	<b>TCRSTA3672</b>	39"	72"	36"	1 ¼"	\$2825	+\$94	+\$129	+\$287	—	+\$370	+\$724	+\$285
	<b>TCRSTA4260</b>	39"	60"	36"	1 ¼"	\$2962	+\$100	+\$135	+\$290	—	+\$370	+\$724	+\$299
	<b>TCRSTA4272</b>	39"	72"	42"	1 ¼"	\$3100	+\$104	+\$141	+\$304	—	+\$370	+\$724	+\$313
 Rectangular Standing Height Table available with Mini Tap power option	<b>TRECSTA3060</b>	39"	60"	30"	1 ¼"	\$2503	+\$70	+\$36	+\$214	—	+\$370	+\$724	+\$252
	<b>TRECSTA3072</b>	39"	72"	30"	1 ¼"	\$2564	+\$85	+\$60	+\$254	—	+\$370	+\$724	+\$259
	<b>TRECSTA3660</b>	39"	60"	36"	1 ¼"	\$2695	+\$84	+\$118	+\$268	—	+\$370	+\$724	+\$273
	<b>TRECSTA3672</b>	39"	72"	36"	1 ¼"	\$2832	+\$94	+\$129	+\$287	—	+\$370	+\$724	+\$286
	<b>TRECSTA4260</b>	39"	60"	42"	1 ¼"	\$2962	+\$100	+\$135	+\$290	—	+\$370	+\$724	+\$299
	<b>TRECSTA4272</b>	39"	72"	42"	1 ¼"	\$3100	+\$104	+\$141	+\$304	—	+\$370	+\$724	+\$313
 Rectangular Standing Height Table with O Legs available with Mini Tap power option	<b>TMRECSTA3060</b>	39"	60"	30"	1 ¼"	\$1839	+\$62	+\$85	+\$181	—	+\$370	+\$724	+\$185
	<b>TMRECSTA3672</b>	39"	72"	36"	1 ¼"	\$1969	+\$66	+\$90	+\$194	—	+\$370	+\$724	+\$198

- Codes come complete with surfaces, legs and optional power
- Worksurfaces are 1 ¼" thick only and available in laminate, grade 1 laminate (plywood edge) and Nuform surface finishes
- When manually specifying worksurface in Laminate, add suffix "-S" to the code
- Laminate is available in straight edge only
- Nuform is available in straight or tapered edge
- Legs are angled and conical shaped with black leveling glides
- Legs are available in Clear Oak (default), Black Oak and Clear Maple finishes
- Standing Height Tables include a foot rail that is available in all standard paint colors. Accent paint colors have an upcharge.
- The Mini Tap power module has a 72" long cord and is available in black only. Module has 1 power + 1 USB.

**NOTES**

In order to get a total cost on products when an upcharge or downcharge is present you take the list price of the product number and add the upcharge or deduct the downcharge cost shown to the list price.

For example:



Product TRNDSTA36 in Nuform Select with a Tapered Edge and 2 power modules would be \$2506 +\$47 +\$25 +\$724

Part number	H	W	D	Thickness	Straight edge Nuform classic/ laminate (base)	Nuform select	Nuform tapered edge	Grade 1 laminate Straight Edge only	Power options			Accent paint
									None	1 module	2 module	
<b>TRNDSTA36</b>	39"	36"	36"	1 ¼"	\$2506	+\$47	+\$25	+\$139	—	+\$370	+\$724	+\$253
<b>TRNDSTA42</b>	39"	42"	42"	1 ¼"	\$2598	+\$64	+\$34	+\$197	—	+\$370	+\$724	+\$263
<b>TRNDSTA48</b>	39"	48"	48"	1 ¼"	\$2694	+\$85	+\$44	+\$254	—	+\$370	+\$724	+\$273





Round Standing Height Table  
available with Mini Tap power option

- Codes come complete with surfaces, legs and optional power
- If power is optioned on tables with the flip up modules, the worksurfaces come with cutout(s)
- Worksurfaces are 1 ¼" thick only and available in laminate, grade 1 laminate (plywood edge) and Nuform surface finishes
- Laminate is available in straight edge only
- When manually specifying worksurface in Laminate, add suffix "-S" to the code
- Nuform is available in straight or tapered edge
- Legs are angled and conical shaped with black leveling glides
- Legs are available in Clear Oak (default), Black Oak and Clear Maple finishes
- The Flip-up power module is available in matte black, matte white and aluminium finishes. Module has 2 outlets + 1 duplex USB + 1 data port.
- The Mini Tap power module has a 72" long cord and is available in black only. Module has 1 power + 1 USB.
- 60" W and 72" W meeting tables can accommodate 1 flip-up power module only
- 84" W and 96" W meeting tables can accommodate 2 flip-up power modules only

	Part number	H	W	D	Thickness	Straight edge Nuform classic/ laminate (base)	Nuform select	Nuform tapered edge	Grade 1 laminate Straight Edge only	Power options		
										None	1 module	2 module
 Curved Rectangular Meeting Table available with Flip-up power option	<b>TCRECMTG3660</b>	28.5"	60"	36"	1 ¼"	\$2058	+\$84	+\$118	+\$251	—	+\$502	—
	<b>TCRECMTG3672</b>	28.5"	72"	36"	1 ¼"	\$2116	+\$94	+\$129	+\$287	—	+\$502	—
	<b>TCRECMTG3684</b>	28.5"	84"	36"	1 ¼"	\$2334	+\$115	+\$157	+\$351	—	—	+\$977
	<b>TCRECMTG3696</b>	28.5"	96"	36"	1 ¼"	\$2433	+\$139	+\$191	+\$427	—	—	+\$977
	<b>TCRECMTG4260</b>	28.5"	60"	42"	1 ¼"	\$2094	+\$93	+\$135	+\$282	—	+\$502	—
	<b>TCRECMTG4272</b>	28.5"	72"	42"	1 ¼"	\$2157	+\$108	+\$162	+\$333	—	+\$502	—
	<b>TCRECMTG4284</b>	28.5"	84"	42"	1 ¼"	\$2381	+\$132	+\$195	+\$404	—	—	+\$977
	<b>TCRECMTG4296</b>	28.5"	96"	42"	1 ¼"	\$2484	+\$161	+\$235	+\$492	—	—	+\$977
	<b>TCRECMTG4860</b>	28.5"	60"	48"	1 ¼"	\$2130	+\$105	+\$156	+\$322	—	+\$502	—
	<b>TCRECMTG4872</b>	28.5"	72"	48"	1 ¼"	\$2198	+\$125	+\$185	+\$380	—	+\$502	—
<b>TCRECMTG4884</b>	28.5"	84"	48"	1 ¼"	\$2427	+\$152	+\$222	+\$466	—	—	+\$977	
<b>TCRECMTG4896</b>	28.5"	96"	48"	1 ¼"	\$2536	+\$185	+\$270	+\$571	—	—	+\$977	
 Curved Rectangular Meeting Table available with Mini Tap power option	<b>TCRECMTG3636</b>	28.5"	36"	36"	1 ¼"	\$1773	+\$56	+\$83	+\$169	—	+\$370	+\$724
	<b>TCRECMTG4242</b>	28.5"	42"	42"	1 ¼"	\$1828	+\$66	+\$97	+\$204	—	+\$370	+\$724
	<b>TCRECMTG4848</b>	28.5"	48"	48"	1 ¼"	\$1888	+\$88	+\$126	+\$265	—	+\$370	+\$724

- Codes come complete with surfaces, legs and optional power
- If power is optioned on tables with the flip up modules, the worksurfaces come with cutout(s)
- Worksurfaces are 1 ¼" thick only and available in laminate, grade 1 laminate (plywood edge) and Nuform surface finishes
- Laminate is available in straight edge only
- When manually specifying worksurface in Laminate, add suffix "-S" to the code
- Nuform is available in straight or tapered edge
- Legs are angled and conical shaped with black leveling glides
- Legs are available in Clear Oak (default), Black Oak and Clear Maple finishes
- The Flip-up power module is available in matte black, matte white and aluminium finishes. Module has 2 outlets + 1 duplex USB + 1 data port.
- The Mini Tap power module has a 72" long cord and is available in black only. Module has 1 power + 1 USB.
- 60" W and 72" W meeting tables can accommodate 1 flip-up power module only
- 84" W and 96" W meeting tables can accommodate 2 flip-up power modules only
- O Legs and foot rails are available in all standard paint colors. Accent paint colors have an upcharge.

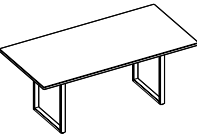
	Part number	H	W	D	Thickness	Straight edge Nuform classic/ laminate (base)	Nuform select	Nuform tapered edge	Grade 1 laminate Straight Edge only	Power options		
										None	1 module	2 module
 Rectangular Meeting Table available with Flip-up power option	<b>TRECMTG3660</b>	28.5"	60"	36"	1 ¼"	\$2058	+\$84	+\$118	+\$251	—	+\$502	—
	<b>TRECMTG3672</b>	28.5"	72"	36"	1 ¼"	\$2116	+\$94	+\$129	+\$287	—	+\$502	—
	<b>TRECMTG3684</b>	28.5"	84"	36"	1 ¼"	\$2334	+\$115	+\$157	+\$351	—	—	+\$977
	<b>TRECMTG3696</b>	28.5"	96"	36"	1 ¼"	\$2433	+\$139	+\$191	+\$427	—	—	+\$977
	<b>TRECMTG4260</b>	28.5"	60"	42"	1 ¼"	\$2094	+\$93	+\$135	+\$282	—	+\$502	—
	<b>TRECMTG4272</b>	28.5"	72"	42"	1 ¼"	\$2157	+\$108	+\$162	+\$333	—	+\$502	—
	<b>TRECMTG4284</b>	28.5"	84"	42"	1 ¼"	\$2381	+\$132	+\$195	+\$404	—	—	+\$977
	<b>TRECMTG4296</b>	28.5"	96"	42"	1 ¼"	\$2484	+\$161	+\$235	+\$492	—	—	+\$977
	<b>TRECMTG4860</b>	28.5"	60"	48"	1 ¼"	\$2130	+\$105	+\$156	+\$322	—	+\$502	—
	<b>TRECMTG4872</b>	28.5"	72"	48"	1 ¼"	\$2198	+\$125	+\$185	+\$380	—	+\$502	—
<b>TRECMTG4884</b>	28.5"	84"	48"	1 ¼"	\$2427	+\$152	+\$222	+\$466	—	—	+\$977	
<b>TRECMTG4896</b>	28.5"	96"	48"	1 ¼"	\$2536	+\$185	+\$270	+\$571	—	—	+\$977	
 Rectangular Meeting Table available with Mini Tap power option	<b>TRECMTG3636</b>	28.5"	36"	36"	1 ¼"	\$1773	+\$56	+\$83	+\$169	—	+\$370	+\$724
	<b>TRECMTG4242</b>	28.5"	42"	42"	1 ¼"	\$1828	+\$66	+\$97	+\$204	—	+\$370	+\$724
	<b>TRECMTG4848</b>	28.5"	48"	48"	1 ¼"	\$1888	+\$88	+\$126	+\$265	—	+\$370	+\$724
 Rectangular Meeting Table with O Legs available with Mini Tap power option	<b>TMRECMTG3672</b>	28.5"	72"	36"	1 ¼"	\$1839	+\$62	+\$85	+\$181	—	+\$502	—
	<b>TMRECMTG4284</b>	28.5"	84"	42"	1 ¼"	\$2081	+\$70	+\$96	+\$205	—	—	+\$977
	<b>TMRECMTG4896</b>	28.5"	96"	48"	1 ¼"	\$2324	+\$78	+\$105	+\$228	—	—	+\$977



**ROUND MEETING TABLE**

- Codes come complete with surfaces, legs and optional power
- Worksurfaces are 1 ¼" thick only and available in laminate, grade 1 laminate (plywood edge) and Nuform surface finishes
- Laminate is available in straight edge only
- When manually specifying worksurface in Laminate, add suffix "-S" to the code
- Nuform is available in straight or tapered edge
- Legs are angled and conical shaped with black leveling glides
- Legs are available in Clear Oak (default), Black Oak and Clear Maple finishes
- The Mini Tap power module has a 72" long cord and is available in black only. Module has 1 power + 1 USB.

**COLLABORATIVE TABLE**

- The table has straight fronts and backs with curved sides. It is available in 1 ¼" thick Nuform and laminate options only
- Table base is available in all paint colors

Part number	H	W	D	Thickness	Straight edge Nuform classic/laminate (base)	Nuform select	Nuform tapered edge	Grade 1 laminate Straight Edge only	Power options		
									None	1 module	2 module
<b>TRNDMTG30</b>	28.5"	30"	30"	1 ¼"	\$1746	+\$36	+\$24	+\$125	—	+\$370	+\$724
<b>TRNDMTG36</b>	28.5"	36"	36"	1 ¼"	\$1749	+\$47	+\$26	+\$139	—	+\$370	+\$724
<b>TRNDMTG42</b>	28.5"	42"	42"	1 ¼"	\$1821	+\$64	+\$34	+\$197	—	+\$370	+\$724
<b>TRNDMTG48</b>	28.5"	48"	48"	1 ¼"	\$1902	+\$85	+\$44	+\$254	—	+\$370	+\$724



Round Meeting Table  
available with Mini Tap power option

Part number	H	W	D	Nuform classic/laminate/base price	Nuform select	Grade 1 laminate	Accent paint
<b>INBCLBTBL</b>	26"	33 ¾"	29 ⅝"	\$1514	+\$77	+\$486	+\$153



Collaborative Table

- Codes come complete with surfaces, legs and optional power
- Worksurfaces are 1 ¼" thick only and available in laminate, grade 1 laminate (plywood edge) and Nuform surface finishes
- When manually specifying worksurface in Laminate, add suffix "-S" to the code
- Laminate is available in straight edge only
- Nuform is available in straight or tapered edge
- Legs are angled and conical shaped with black leveling glides
- Legs are available in Clear Oak (default), Black Oak and Clear Maple finishes
- The Mini Tap power module has a 72" long cord and is available in black only. Module has 1 power + 1 USB.

**NOTE**

In order to get a total cost on products when an upcharge or downcharge is present you take the list price of the product number and add the upcharge or deduct the downcharge cost shown to the list price.

For example:

Product TCRCOF30 in Nuform Select with a Tapered Edge and 2 power modules would be \$1214 +\$45 +\$25 +\$724

Part number	H	W	D	Thickness	Straight edge Nuform classic/ laminate (base)	Nuform select	Nuform tapered edge	Grade 1 laminate Straight Edge only	Power options		
									None	1 module	2 module
<b>TCRCOF30</b>	17"	30"	30"	1 ¼"	\$1214	+\$45	+\$25	+\$132	—	+\$370	+\$724
<b>TCRCOF36</b>	17"	36"	36"	1 ¼"	\$1305	+\$56	+\$83	+\$169	—	+\$370	+\$724
<b>TCRCOF42</b>	17"	42"	42"	1 ¼"	\$1359	+\$66	+\$97	+\$204	—	+\$370	+\$724



Curved Rectangular Coffee Table

available with Mini Tap power option

<b>TSQUCOF30</b>	17"	30"	30"	1 ¼"	\$1214	+\$45	+\$25	+\$132	—	+\$370	+\$724
<b>TSQUCOF36</b>	17"	36"	36"	1 ¼"	\$1305	+\$56	+\$83	+\$169	—	+\$370	+\$724
<b>TSQUCOF42</b>	17"	42"	42"	1 ¼"	\$1359	+\$66	+\$97	+\$204	—	+\$370	+\$724



Rectangular Coffee Table

available with Mini Tap power option

<b>TRNDCOF30</b>	17"	30"	30"	1 ¼"	\$1214	+\$43	+\$25	+\$126	—	+\$370	+\$724
<b>TRNDCOF36</b>	17"	36"	36"	1 ¼"	\$1280	+\$47	+\$26	+\$139	—	+\$370	+\$724
<b>TRNDCOF42</b>	17"	42"	42"	1 ¼"	\$1354	+\$64	+\$34	+\$197	—	+\$370	+\$724



Round Coffee Table

available with Mini Tap power option

# Tables Worksurfaces

**inscape**

work for tomorrow

## Worksurfaces

Square and Rectangular Tops

## Tables

- 60"-72" W rectangular tops require a stretcher bar
- 78" W and over rectangular tops require a center leg
- Tables are true to size
- When manually specifying worksurface in Laminate, add suffix "-S" to the code
- The tapered edge option on the 30" and 36" deep worksurfaces will only be on the front edge if specified
- The tapered edge option on the 42" and 48" deep worksurfaces will be on the all four sides if specified





### NOTE

In order to get a total cost on products when an upcharge or downcharge is present you take the list price of the product number and add the upcharge or deduct the downcharge cost shown to the list price.

For example:

Product TW3030 in Nuform Select with a Tapered Edge would be \$393 +\$45 +\$25

Product TW3030 in Nuform Select with a 1" Straight Edge would be \$393 +\$45 -\$44

	Part number	W	D	1.25" Straight edge Nuform classic/laminate (base)	Nuform select	Nuform tapered edge	1" Straight edge Nuform	Grade 1 laminate Straight Edge only
 30" D Rectangular Top	TW3030	30"	30"	\$393	+\$45	+\$25	-\$44	+\$128
	TW3036	36"	30"	\$448	+\$48	+\$26	-\$47	+\$144
	TW3042	42"	30"	\$472	+\$51	+\$26	-\$50	+\$153
	TW3048	48"	30"	\$538	+\$58	+\$31	-\$56	+\$173
	TW3054	54"	30"	\$604	+\$63	+\$32	-\$61	+\$196
	TW3060	60"	30"	\$674	+\$69	+\$34	-\$69	+\$216
	TW3066	66"	30"	\$720	+\$73	+\$37	-\$73	+\$233
	TW3072	72"	30"	\$807	+\$84	+\$42	-\$84	+\$259
	TW3078	78"	30"	\$895	+\$91	+\$47	-\$90	+\$288
	TW3084	84"	30"	\$980	+\$102	+\$52	-\$101	+\$316
	TW3090	90"	30"	\$1066	+\$108	+\$57	-\$108	+\$343
TW3096	96"	30"	\$1156	+\$119	+\$60	-\$118	+\$371	
 36" D Rectangular Top	TW3636	36"	36"	\$519	+\$56	+\$83	-\$56	+\$168
	TW3642	42"	36"	\$548	+\$57	+\$86	-\$58	+\$177
	TW3648	48"	36"	\$621	+\$66	+\$98	-\$69	+\$201
	TW3654	54"	36"	\$699	+\$73	+\$106	-\$69	+\$225
	TW3660	60"	36"	\$783	+\$84	+\$118	-\$84	+\$252
	TW3666	66"	36"	\$830	+\$87	+\$124	-\$87	+\$267
	TW3672	72"	36"	\$935	+\$94	+\$129	-\$94	+\$301
	TW3678	78"	36"	\$1036	+\$103	+\$142	-\$101	+\$332
	TW3684	84"	36"	\$1138	+\$115	+\$157	-\$111	+\$366
	TW3690	90"	36"	\$1251	+\$128	+\$173	-\$121	+\$402
	TW3696	96"	36"	\$1374	+\$139	+\$191	-\$132	+\$441
 42" D Rectangular Top	TW4242	42"	42"	\$639	+\$66	+\$97	—	+\$206
	TW4260	60"	42"	\$909	+\$93	+\$135	—	+\$292
	TW4272	72"	42"	\$1083	+\$108	+\$162	—	+\$348
	TW4284	84"	42"	\$1306	+\$132	+\$195	—	+\$420
	TW4296	96"	42"	\$1577	+\$161	+\$235	—	+\$506
 48" D Rectangular Top	TW4848	48"	48"	\$831	+\$88	+\$126	—	+\$267
	TW4860	60"	48"	\$1044	+\$105	+\$156	—	+\$334
	TW4872	72"	48"	\$1244	+\$125	+\$185	—	+\$399
	TW4884	84"	48"	\$1502	+\$152	+\$222	—	+\$481
	TW4896	96"	48"	\$1811	+\$185	+\$270	—	+\$582





- Racetrack Tops for use with 2 cylindrical table bases
- Bases are not included. See Legs and Bases section
- Tables are true to size
- When manually specifying worksurface in Laminate, add suffix “-S” to the code
- Stretcher bars are required for unsupported worksurfaces of 54" W or wider

**NOTE**

In order to get a total cost on products when an upcharge or downcharge is present you take the list price of the product number and add the upcharge or deduct the downcharge cost shown to the list price.

For example:

Product TWRT3672 in Nuform Select with a Tapered Edge would be \$989 +\$99 +\$134

	Part number	W	D	1.25" Straight edge Nuform classic/laminate (base)	Nuform select	Nuform tapered edge	1" Straight edge Nuform	Grade 1 laminate Straight Edge only
	<b>TWRT3672</b>	72"	36"	\$989	+\$99	+\$134	—	+\$318
	<b>TWRT4284</b>	84"	42"	\$1372	+\$138	+\$205	—	+\$441
	<b>TWRT4896</b>	96"	48"	\$1900	+\$195	+\$282	—	+\$610
Racetrack Top For use with 2 cylindrical table bases								
	<b>TWBT3672</b>	72"	36"	\$989	+\$99	+\$134	—	+\$318
36" D Boat Top								
	<b>TWBT4284</b>	84"	42"	\$1372	+\$138	+\$205	—	+\$441
	<b>TWBT4296</b>	96"	42"	\$1656	+\$168	+\$247	—	+\$532
42" D Boat Top								
	<b>TWBT4884</b>	84"	48"	\$1576	+\$160	+\$282	—	+\$506
	<b>TWBT4896</b>	96"	48"	\$1900	+\$2056	+\$2144	—	+\$610
48" D Boat Top								

- Tables are true to size
- When manually specifying worksurface in Laminate, add suffix “-S” to the code





**NOTE**

In order to get a total cost on products when an upcharge or downcharge is present you take the list price of the product number and add the upcharge or deduct the downcharge cost shown to the list price.

For example:

Product TWRND30 in Nuform Select with a Tapered Edge would be \$431 +\$43 +\$25

Product TWRND30 in Nuform Select with a 1" Straight Edge would be \$431 +\$43 -\$25

	Part number	W	D	1.25" Straight edge Nuform classic/laminate (base)	Nuform select	Nuform tapered edge	1" Straight edge Nuform	Grade 1 laminate Straight Edge only
 30" D Round Top	<b>TWRND30</b>	30"	30"	\$431	+\$43	+\$25	-\$25	+\$139
 36" D Round Top	<b>TWRND36</b>	36"	36"	\$474	+\$47	+\$26	-\$27	+\$153
 42" D Round Top	<b>TWRND42</b>	42"	42"	\$658	+\$64	+\$34	-\$34	+\$212
 48" D Round Top	<b>TWRND48</b>	48"	48"	\$829	+\$85	+\$44	-\$44	+\$267

- Requires 2 legs and 2 flush brackets
- Legs and brackets are not included. See Legs and Bases section
- Tables are true to size
- Grain direction runs from straight edge towards arc on the 42" W and 48" W surfaces
- Grain direction runs from side to side on the 60" W and 72" W surfaces
- When manually specifying worksurface in Laminate, add suffix "-S" to the code
- Stretcher bars are required for unsupported worksurfaces of 54" W or wider

**NOTE**

In order to get a total cost on products when an upcharge or downcharge is present you take the list price of the product number and add the upcharge or deduct the downcharge cost shown to the list price.

For example:

Product TWSC4221 in Nuform Select with a Tapered Edge would be \$475 +\$54 +\$30

Product TWSC4221 in Nuform Select with a 1" Straight Edge would be \$475 +\$54 -\$52

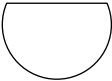
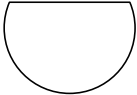
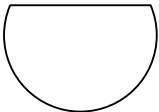
	Part number	W	D	1.25" Straight edge Nuform classic/laminate (base)	Nuform select	Nuform tapered edge	1" Straight edge Nuform	Grade 1 laminate Straight Edge only
 42" W Semi-circle Top	<b>TWSC4221</b>	42"	21"	\$475	+\$54	+\$30	-\$52	+\$154
 48" W Semi-circle Top	<b>TWSC4824</b>	48"	24"	\$591	+\$63	+\$32	-\$63	+\$191
 60" W Semi-circle Top	<b>TWSC6030</b>	60"	30"	\$823	+\$86	+\$42	-\$85	+\$265
 72" W Semi-circle Top	<b>TWSC7236</b>	72"	36"	\$1053	+\$104	+\$48	-\$102	+\$339

- Requires one post leg and 2 flush mount brackets
- Legs and brackets are not included. See Legs and Bases section
- Tables are true to size
- When manually specifying worksurface in Laminate, add suffix "-S" to the code



**NOTE**

In order to get a total cost on products when an upcharge or downcharge is present you take the list price of the product number and add the upcharge or deduct the downcharge cost shown to the list price.

For example:

Product TWQC30 in Nuform Select with a Tapered Edge would be \$413 +\$44 +\$22

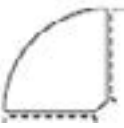
Product TWQC30 in Nuform Select with a 1" Straight Edge would be \$413 +\$44 -\$43

	Part number	W	D	1.25" Straight edge Nuform classic/laminate (base)	Nuform select	Nuform tapered edge	1" Straight edge Nuform	Grade 1 laminate Straight Edge only
 30" D Quarter-circle Top	<b>TWQC30</b>	30"	30"	\$413	+\$44	+\$22	-\$43	+\$133
 36" D Quarter-circle Top	<b>TWQC36</b>	36"	36"	\$529	+\$54	+\$26	-\$52	+\$171





- Tables are true to size
- When manually specifying worksurface in Laminate, add suffix “-S” to the code
- Stretcher bars are required for unsupported worksurfaces of 54" W or wider

**NOTE**

In order to get a total cost on products when an upcharge or downcharge is present you take the list price of the product number and add the upcharge or deduct the downcharge cost shown to the list price.

For example:

Product TWTRAP3060 in Nuform Select with a 1" Straight Edge would be \$738 +\$74 -\$73

	Part number	W	D	1.25" Straight edge Nuform classic/laminate (base)	Nuform select	Nuform tapered edge	1" Straight edge Nuform	Grade 1 laminate Straight Edge only
 Trapezoid Top 30"x30"x60"	<b>TWTRAP3060</b>	60"	—	\$738	+\$74	—	-\$73	+\$238
 Trapezoid Top 24"x24"x48"	<b>TWTRAP2448</b>	48"	—	\$556	+\$57	—	-\$57	+\$179

## Worksurfaces

Hex, Pebble and Rhombus Tops

# Tables





- Tables are true to size
- Not available in tapered edge
- Stretcher bars are required for unsupported worksurfaces of 54" W or wider
- When manually specifying worksurface in Laminate, add suffix "-S" to the code
- Pebble Top for use with 1 cylindrical table base only
- Rhombus Top for use with 2 cylindrical table bases only

### NOTE

In order to get a total cost on products when an upcharge or downcharge is present you take the list price of the product number and add the upcharge or deduct the downcharge cost shown to the list price.

For example:

Product TWHEXL3072 in Nuform Select with a 1" Straight Edge would be \$882 +\$90 -\$89

	Part number	W	D	1.25" Straight edge Nuform classic/ laminate (base)	Nuform select	Nuform tapered edge	1" Straight edge Nuform
	<b>TWHEXL3072</b> left-handed	72"	30"	\$882	+\$90	—	-\$89
Hex Top							
	<b>TWHEXR3072</b> right-handed	72"	30"	\$882	+\$90	—	-\$89
Hex Top							
	<b>TWPEB3648</b>	48"	36"	\$871	+\$88	—	-\$46
Pebble Top							
	<b>TWROM4890</b>	90"	48"	\$1900	+\$195	—	-\$183
Rhombus Top							

## Worksurfaces

### Rectangular Tops with Power Module

## Tables





- 60" & 72" W rectangular tops require a stretcher bar
- 78" W and over rectangular tops require a center leg
- 30" & 36" deep surfaces include power modules positioned 2" in from the back edge. 60" and 72" W have one module and 84" & 96" have two modules
- 42" & 48" deep surfaces include power modules centered front to back. 60" & 72" W have one module and 84" and 96" have two modules
- When manually specifying worksurface in Laminate, add suffix "-S" to the code
- Stretcher bars are required for unsupported worksurfaces of 54" W or wider
- Rectangular Tops with Flip Up Power Module are not available in Nuform

### NOTES

In order to get a total cost on products when an upcharge or downcharge is present you take the list price of the product number and add the upcharge or deduct the downcharge cost shown to the list price.

For example:

Product TWP3060-S in Grade 1 laminate would be \$1583 +\$508

	Part number	W	D	1.25" Straight edge Nuform classic/laminate (base)	Nuform select	Nuform tapered edge	1" Straight edge Nuform	Grade 1 laminate Straight Edge only
 30" D Rectangular Top with power module	<b>TWP3060-S</b>	60"	30"	\$1583	—	—	—	+\$508
	<b>TWP3072-S</b>	72"	30"	\$1714	—	—	—	+\$550
	<b>TWP3084-S</b>	84"	30"	\$1888	—	—	—	+\$606
	<b>TWP3096-S</b>	96"	30"	\$2063	—	—	—	+\$661
 36" D Rectangular Top with power module	<b>TWP3660-S</b>	60"	36"	\$1691	—	—	—	+\$543
	<b>TWP3672-S</b>	72"	36"	\$1841	—	—	—	+\$590
	<b>TWP3684-S</b>	84"	36"	\$2037	—	—	—	+\$654
	<b>TWP3696-S</b>	96"	36"	\$2273	—	—	—	+\$729
 42" D Rectangular Top with power module	<b>TWP4260-S</b>	60"	42"	\$1807	—	—	—	+\$580
	<b>TWP4272-S</b>	72"	42"	\$1981	—	—	—	+\$636
	<b>TWP4284-S</b>	84"	42"	\$2205	—	—	—	+\$708
	<b>TWP4296-S</b>	96"	42"	\$2475	—	—	—	+\$793
 48" D Rectangular Top with power module	<b>TWP4860-S</b>	60"	48"	\$1942	—	—	—	+\$624
	<b>TWP4872-S</b>	72"	48"	\$2142	—	—	—	+\$686
	<b>TWP4884-S</b>	84"	48"	\$2398	—	—	—	+\$769
	<b>TWP4896-S</b>	96"	48"	\$2709	—	—	—	+\$869

## Worksurfaces

Bullet, Bean, Oval and Curved Rectangular Tops

## Tables

- Stretcher bars are required for unsupported worksurfaces of 54" W or wider
- When manually specifying worksurface in Laminate, add suffix "-S" to the code





### NOTES

In order to get a total cost on products when an upcharge or downcharge is present you take the list price of the product number and add the upcharge or deduct the downcharge cost shown to the list price.

For example:

Product TCTB2460 in Nuform Select would be \$658 +\$70

Product TCTB2460 in Nuform Select with a 1" Straight Edge would be \$658 +\$70 -\$67



	Part number	W	D	1.25" Straight edge Nuform classic/laminate (base)	Nuform select	Nuform tapered edge	1" Straight edge Nuform	Grade 1 laminate Straight Edge only
 Bullet Top	<b>TCTB2460</b>	60"	24"	\$658	+\$70	—	-\$67	+\$212
	<b>TCTB2466</b>	66"	24"	\$722	+\$73	—	-\$73	+\$234
	<b>TCTB2472</b>	72"	24"	\$788	+\$86	—	-\$85	+\$253
	<b>TCTB3060</b>	60"	30"	\$822	+\$89	—	-\$88	+\$265
	<b>TCTB3066</b>	66"	30"	\$875	+\$91	—	-\$90	+\$282
	<b>TCTB3072</b>	72"	30"	\$984	+\$102	—	-\$101	+\$317
 Bean Top	<b>TB2748</b>	48"	27"	\$493	+\$70	—	-\$67	+\$160
 Oval Top	<b>TOM3048</b>	48"	30"	\$658	+\$70	—	-\$67	+\$212
 Curved Rectangular Top	<b>TCUR27405</b>	40 1/2"	27"	\$463	+\$50	—	-\$48	+\$148

# Tables Legs & Bases



**inscape**

work for tomorrow



- Height adjustable leg provides manual adjustability to five heights -25.5", 27", 28.5", 30", 31.5"
- Legs are available in any of Inscape's standard paint colors. Accent paint colors have an upcharge.
- To adjust the height there are two bolts that unthread and then pull out so that inner leg can then move up or down
- Round caster legs recommended to be used 2 with a brake and 2 without

		Part number	H	D	Wt (lbs)	Neutral paint/ base price	Accent paint
	"H" Leg Fixed Height	<b>THLEG2428.5</b>	28 ½"	24"	—	\$485	+\$51
		<b>THLEG3028.5</b>	28 ½"	30"	—	\$511	+\$53
		<b>THLEG3628.5</b>	28 ½"	36"	—	\$529	+\$56
	"O" Leg Fixed Height	<b>TOLEG2428.5</b>	28 ½"	24"	—	\$403	+\$44
		<b>TOLEG3028.5</b>	28 ½"	30"	—	\$416	+\$45
		<b>TOLEG3628.5</b>	28 ½"	36"	—	\$421	+\$45
	Round Caster Leg	<b>TRNDLEGCASTER</b>	28 ½"	—	—	\$250	+\$27

- Height adjustable leg provides manual adjustability to five heights -25.5", 27", 28.5", 30", 31.5"
- Legs are available in any of Inscape's standard paint colors. Accent paint colors have an upcharge.

		Part number	H	D	Wt (lbs)	Neutral paint/ base price	Accent paint
	Post Leg Visual to match Height Adjustable Table launched June 2017	<b>INPLAK28.5</b>	28 ½"	—	—	\$300	+\$32
	Freestanding "C" Leg for 24"D worksurfaces Visual to match Height Adjustable Table launched June 2017	<b>INLAKFLEG24LH</b> left hand (illustrated)	28 ½"	—	—	\$347	+\$36
		<b>INLAKFLEG24RH</b> right hand	28 ½"	—	—	\$347	+\$36
	Freestanding "C" Leg for 30"D worksurfaces Visual to match Height Adjustable Table launched June 2017	<b>INLAKFLEG30LH</b> left hand (illustrated)	28 ½"	—	—	\$353	+\$37
		<b>INLAKFLEG30RH</b> right hand	28 ½"	—	—	\$353	+\$37

- Height adjustable leg provides manual adjustability to five heights -25.5", 27", 28.5", 30", 31.5"
- Legs are available in any of Inscape's standard paint colors

		Part number	H	D	Wt (lbs)	Neutral paint/ base price	Accent paint
	Post Leg Fixed Height With black slide glide	<b>TLEG28.5F</b>	28 ½"	—	3	\$192	+\$22
	Triangular Leg	<b>TWMLEG-28.5</b>	28 ½"	—	—	\$258	+\$27
	Rectangular Post Leg Fixed Height	<b>TRECPLEG-28.5</b>	28 ½"	—	—	\$167	+\$20



- Legs available in any of Inscape's standard paint colors (except cylindrical table base). Accent paint colors have an upcharge.
- Limited color options with Cylindrical Table Base
- Base only
- Cylindrical Table bases only for use with Round, Pebble, Racetrack and Rhombus Tops
- 2 Cylindrical Table bases required for Racetrack and Rhombus Tops

	Part number	H	Wt (lbs)	Neutral paint/ base price	Accent paint
 <p>"X" Table Base Top specified separately</p>	<b>TX-BASE30</b> For use with 30" and 36" W Round tops only	—	—	\$1282	+\$131
	<b>TX-BASE36</b> For use with 42" and 48" W Round tops only	—	—	\$1321	+\$134



	Part number	H	White/ base price	Silver
 <p>Cylindrical Table Base Available in white &amp; silver only Top specified separately</p>	<b>TCBASE-20</b>	20"	\$1955	\$20
	<b>TCBASE-28.5</b>	28 ½"	\$1978	\$21
	<b>TCBASE-42</b>	42"	\$2010	\$23

# Tables Accessories

**inscape**

work for tomorrow

- Link bracket is specified to link two tables together
- Stretcher bars are required to be specified with worksurfaces 54" and wider which do have any mid support
- Stretcher bars are 1 ½" H

		Part number	Wt (lbs)	List price
	Table Link Bracket	<b>LBRKT</b>	—	\$74
	Flush Bracket Kit of 2	<b>INFB</b>	0.2	\$18
	20" Flush Bracket	<b>INFB20</b>	1	\$26

		Part number	W	Wt (lbs)	Eco black	Painted	
	Worksurface Stretcher Bar For use with worksurfaces 54" and wider	<b>INSBK54</b>	44"	—	\$77	—	
		For use with 54" surface					
		<b>INSBK60</b>	50"	—	\$114	—	
		For use with 60" surface					
		<b>INSBK72</b>	62"	—	\$135	—	
For use with 72" surface							
		<b>INSBK84</b>	74"	—	\$162	—	
For use with 84" surface							
		<b>INSBK96</b>	86"	—	\$183	—	
For use with 96" surface							

- Table mounted screens mount to worksurfaces
- Adjustable Framed Table Mounted Screens have height adjustment for above worksurface privacy and below the worksurface modesty. It is recommended that this screen be installed with a max of 20" above the surface.
- Table Mounted Screen/Modesty has 14" of the tackboard mounted above the surface and 13 ½" below
- Table Mounted Acrylic Screens have approx. 16" of screen above the surface and approx. 3" below the surface
- Freestanding Table Screen is made of 6mm thick frosted acrylic which is 13" H, seated in a painted aluminum extrusion, which can be painted any of Inscape's standard colors. This screen is 5" less in depth than depth of worksurface it will be placed on

**NOTES**

In order to get a total cost on products when upcharges are present take the list price of the product number and add the upcharge cost shown to the list price.

For example:

Product TMST3736 in Grade 3 Fabric would be \$607 +\$90

Product TSWTMS48 in Frosted Acrylic would be \$867 +\$103

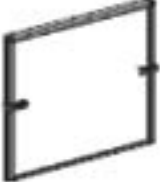
Part number	H	D	Wt (lbs)	Grade 1/ base price	Grade 2	Grade 3	Grade 4	Grade 5	Grade 6	Grade 7	Grade 8	Accent paint
 <b>TMST3736</b>	37"	36"	13	\$607	+\$58	+\$90	—	+\$156	+\$289	+\$426	—	+\$63
<b>TMST3742</b>	37"	42"	15	\$633	+\$59	+\$91	—	+\$156	+\$293	+\$430	—	+\$65
<b>TMST3748</b>	37"	48"	16	\$658	+\$64	+\$92	—	+\$157	+\$296	+\$435	—	+\$67
<b>TMST3754</b>	37"	54"	18	\$681	+\$66	+\$98	—	+\$160	+\$305	+\$444	—	+\$70
<b>TMST3760</b>	37"	60"	19	\$705	+\$72	+\$103	—	+\$160	+\$312	+\$455	—	+\$72

37" H Adjustable Framed  
Table Mounted Screen  
Tackable



Part number	H	W	Grade A/ base price	Grade B/ COM	Grade C	Grade D	Grade E	Grade F	Accent paint
 <b>INTMSF2948</b>	29"	48"	\$1281	+\$182	+\$499	+\$967	+\$1165	+\$1590	+\$130
<b>INTMSF2954</b>	29"	54"	\$1300	+\$354	+\$691	+\$1170	+\$1394	+\$1956	+\$132
<b>INTMSF2960</b>	29"	60"	\$1387	+\$405	+\$781	+\$1306	+\$1555	+\$2175	+\$141

Table Mounted  
Screen/Modesty  
Tackable

Part number	H	D	Wt (lbs)	Clear acrylic	White acrylic	Frosted acrylic
 Table Mounted Acrylic Screen <b>TSWTMS48</b>	20"	48"	4	\$867	+\$103	+\$103
<b>TSWTMS54</b>	20"	54"	5	\$1359	+\$214	+\$214
<b>TSWTMS60</b>	20"	60"	6	\$1575	+\$213	+\$213

Part number	H	D	Wt (lbs)	Neutral paint/ base price	Accent paint
 Freestanding Table Screen <b>TINSPS24</b>	13"	19"	2	\$121	+\$16
<b>TINSPS30</b>	13"	25"	2	\$169	+\$20
<b>TINSPS32</b>	13"	28"	2	\$177	+\$20
<b>TINSPS36</b>	13"	31"	2	\$183	+\$21

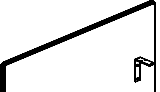
- Modesty panels are available in a variety of materials and mounting options correspond with each variety
- Modesty panels mount to the underside of worksurface and are field installed
- See Application Guide for specific dimension detailed applications
- All hardware included
- Specify modesty panels 12" shorter then the surface length when being used with a Height Adjustable Table

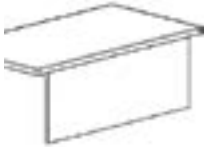
	Part number	H	W	Neutral paint/ base price	Accent paint	
	Painted Partial Height Modesty Panel	<b>TMDPNP30</b>	13.5"	30"	\$135	+\$17
		<b>TMDPNP33</b>	13.5"	33"	\$139	+\$17
		<b>TMDPNP36</b>	13.5"	36"	\$141	+\$17
		<b>TMDPNP39</b>	13.5"	39"	\$144	+\$18
		<b>TMDPNP42</b>	13.5"	42"	\$147	+\$18
		<b>TMDPNP45</b>	13.5"	45"	\$152	+\$18
		<b>TMDPNP48</b>	13.5"	48"	\$159	+\$19
		<b>TMDPNP51</b>	13.5"	51"	\$161	+\$19
		<b>TMDPNP54</b>	13.5"	54"	\$164	+\$19
		<b>TMDPNP57</b>	13.5"	57"	\$167	+\$20
		<b>TMDPNP60</b>	13.5"	60"	\$169	+\$20
		<b>TMDPNP63</b>	13.5"	63"	\$171	+\$20
		<b>TMDPNP66</b>	13.5"	66"	\$173	+\$20
		<b>TMDPNP69</b>	13.5"	69"	\$174	+\$20
		<b>TMDPNP72</b>	13.5"	72"	\$178	+\$21

- Modesty panels are available in a variety of materials and mounting options correspond with each variety
- Modesty panels mount to the underside of worksurface and are field installed
- See Application Guide for specific dimension detailed applications
- All hardware included
- Specify modesty panels 12" shorter then the surface length when being used with a Height Adjustable Table
- The Nuform option has a gray backer
- The laminate option is laminate on both sides with a self edge

**NOTES**

In order to get a total cost on products when upcharges are present take the list price of the product number and add the upcharge cost shown to the list price.

For example:

Product TMDPNW30 in Grade 1 laminate would be \$312 +\$101

	Part number	H	W	Nuform classic/ laminate/base price	Nuform select	Grade 1 laminate	Accent paint
 <p>Wood Core Partial Height Modesty Panel</p>	<b>TMDPNW30</b>	13.5"	30"	\$312	+\$35	+\$101	+\$33
	<b>TMDPNW33</b>	13.5"	33"	\$333	+\$37	+\$107	+\$35
	<b>TMDPNW36</b>	13.5"	36"	\$342	+\$39	+\$111	+\$36
	<b>TMDPNW39</b>	13.5"	39"	\$382	+\$44	+\$125	+\$42
	<b>TMDPNW42</b>	13.5"	42"	\$389	+\$45	+\$127	+\$43
	<b>TMDPNW45</b>	13.5"	45"	\$399	+\$46	+\$130	+\$44
	<b>TMDPNW48</b>	13.5"	48"	\$405	+\$47	+\$131	+\$44
	<b>TMDPNW51</b>	13.5"	51"	\$444	+\$50	+\$143	+\$48
	<b>TMDPNW54</b>	13.5"	54"	\$452	+\$51	+\$145	+\$48
	<b>TMDPNW57</b>	13.5"	57"	\$463	+\$52	+\$148	+\$49
	<b>TMDPNW60</b>	13.5"	60"	\$485	+\$54	+\$158	+\$51
	<b>TMDPNW63</b>	13.5"	63"	\$566	+\$63	+\$182	+\$59
	<b>TMDPNW66</b>	13.5"	66"	\$590	+\$66	+\$191	+\$61
	<b>TMDPNW69</b>	13.5"	69"	\$612	+\$69	+\$198	+\$63
	<b>TMDPNW72</b>	13.5"	72"	\$637	+\$71	+\$206	+\$65
	<b>TMDPNW75</b>	13.5"	75"	\$709	\$709	+\$228	+\$72
	<b>TMDPNW78</b>	13.5"	78"	\$714	+\$80	+\$231	+\$73
	<b>TMDPNW81</b>	13.5"	81"	\$722	+\$81	+\$234	+\$73
	<b>TMDPNW84</b>	13.5"	84"	\$726	+\$81	+\$235	+\$74
<b>TMDPNW87</b>	13.5"	87"	\$733	+\$83	+\$237	+\$74	
<b>TMDPNW90</b>	13.5"	90"	\$737	+\$83	+\$238	+\$76	

- Modesty panels are available in a variety of materials and mounting options correspond with each variety
- Modesty panels mount to the underside of worksurface and are field installed
- See Application Guide for specific dimension detailed applications
- All hardware included
- Specify modesty panels 12" shorter then the surface length when being used with a Height Adjustable Table



	Part number	H	W	Neutral paint/ base price	Accent paint
Acrylic Partial Height Modesty Panel	<b>TMDPNA30</b>	13.5"	30"	\$510	—
	<b>TMDPNA33</b>	13.5"	33"	\$515	—
	<b>TMDPNA36</b>	13.5"	36"	\$523	—
	<b>TMDPNA39</b>	13.5"	39"	\$529	—
	<b>TMDPNA42</b>	13.5"	42"	\$535	—
	<b>TMDPNA45</b>	13.5"	45"	\$547	—
	<b>TMDPNA48</b>	13.5"	48"	\$552	—
	<b>TMDPNA51</b>	13.5"	51"	\$576	—
	<b>TMDPNA54</b>	13.5"	54"	\$602	—
	<b>TMDPNA57</b>	13.5"	57"	\$625	—
	<b>TMDPNA60</b>	13.5"	60"	\$657	—
	<b>TMDPNA63</b>	13.5"	63"	\$686	—
	<b>TMDPNA66</b>	13.5"	66"	\$720	—
	<b>TMDPNA69</b>	13.5"	69"	\$749	—
	<b>TMDPNA72</b>	13.5"	72"	\$782	—
	<b>TMDPNA75</b>	13.5"	75"	\$796	—
	<b>TMDPNA78</b>	13.5"	78"	\$815	—
	<b>TMDPNA81</b>	13.5"	81"	\$831	—
	<b>TMDPNA84</b>	13.5"	84"	\$849	—
<b>TMDPNA87</b>	13.5"	87"	\$867	—	
<b>TMDPNA90</b>	13.5"	90"	\$885	—	

- Modesty panels are available in a variety of materials and mounting options correspond with each variety
- Modesty panels mount to the underside of worksurface and are field installed
- See Application Guide for specific dimension detailed applications
- All hardware included
- Specify modesty panels 12" shorter then the surface length when being used with a Height Adjustable Table
- The Nuform option has a gray backer
- The laminate option is laminate on both sides with a self edge
- Nuform finish is on one side with white backer

**NOTES**

In order to get a total cost on products when upcharges are present take the list price of the product number and add the upcharge cost shown to the list price.

For example:

Product TMDFHPNW30 in Grade 1 laminate would be \$401 +\$130









Wood Core Full Height Modesty Panel



Part number	H	W	Nuform classic/ laminate/base price	Nuform select	Grade 1 laminate	Accent paint
<b>TMDFHPNW30</b>	24"	30"	\$401	+\$46	+\$130	+\$44
<b>TMDFHPNW33</b>	24"	33"	\$437	+\$50	+\$141	+\$47
<b>TMDFHPNW36</b>	24"	36"	\$445	+\$50	+\$144	+\$48
<b>TMDFHPNW39</b>	24"	39"	\$509	+\$58	+\$165	+\$53
<b>TMDFHPNW42</b>	24"	42"	\$519	+\$59	+\$168	+\$54
<b>TMDFHPNW45</b>	24"	45"	\$465	+\$52	+\$151	+\$49
<b>TMDFHPNW48</b>	24"	48"	\$540	+\$61	+\$174	+\$57
<b>TMDFHPNW51</b>	24"	51"	\$668	+\$74	+\$215	+\$69
<b>TMDFHPNW54</b>	24"	54"	\$680	+\$77	+\$219	+\$70
<b>TMDFHPNW57</b>	24"	57"	\$688	+\$77	+\$221	+\$71
<b>TMDFHPNW60</b>	24"	60"	\$708	+\$79	+\$228	+\$72
<b>TMDFHPNW63</b>	24"	63"	\$737	+\$83	+\$238	+\$76
<b>TMDFHPNW66</b>	24"	66"	\$756	+\$85	+\$243	+\$77
<b>TMDFHPNW69</b>	24"	69"	\$778	+\$87	+\$250	+\$81
<b>TMDFHPNW72</b>	24"	72"	\$793	+\$89	+\$255	+\$83
<b>TMDFHPNW75</b>	24"	75"	\$906	+\$101	+\$291	+\$93
<b>TMDFHPNW78</b>	24"	78"	\$912	+\$102	+\$293	+\$94
<b>TMDFHPNW81</b>	24"	81"	\$917	+\$102	+\$294	+\$94
<b>TMDFHPNW84</b>	24"	84"	\$924	+\$103	+\$296	+\$96
<b>TMDFHPNW87</b>	24"	87"	\$929	+\$103	+\$299	+\$96
<b>TMDFHPNW90</b>	24"	90"	\$939	+\$104	+\$302	+\$97



- Grommets must be field installed
- Round Grommet = 2" diameter
- Rectangular Grommet = 3" x 5.25"
- Power Modules mount to the back edge of a surface and are accessible by the user above the surface
- Power Modules plug into the duplexes
- The Clamp-On Power Module is available in a black or white finish. It has a 96" long power cord and LED surge protection indication. It attaches to 1" and 1 ¼" thick worksurfaces and the mount includes a device holder.
- The Clamp-On Power Module with Colored Components comes in many different configurations with receptacles, USB (1 type A and 1 type B) ports and availability lights. Power Modules come in black, white or gray and have colored options for the lid; Black, White, Teal, Red, Purple, Blue, Green, Gray. The availability light is user controlled and requires free software download.
- All electrical components on this page are field installed

	Part number	Dimensions	List/ base price	Black	White	Silver	Stainless steel
	<b>PLNGRKIT</b>	5 ¼"	\$208	+\$0	—	—	+\$85
	<b>GROMMET-WS</b>	—	\$18	+\$0	—	—	—
	Part number						List price
	<b>INPMOD-3P1U</b>						\$173
	<b>INBPMOD-1P1U</b>						\$437
	<b>INBPMOD-2P1U1O</b>						\$548
	<b>INBPMOD-2P1U1L</b>						\$867

- Flip-up Power & Data Module is finished with a clear anodized aluminum with white inserts and a 72" long power cord
- Mini Tap and Flip-up Module include clips and screws for basic wire management
- All electrical components on this page are field installed when specified separately from a table

		Part number	H	W	D	Wt (lbs)	List price
	Flip-up Power & Data Module 2 outlets + 1 dual USB + 1 data finished in aluminium with white insert	<b>PVDMODFL</b>	—	—	—	—	\$902
	Mini Tap Undermount Power Module available in black only	<b>PVDMODSMT-1P1U</b> Single Configuration: 1 Power + 1 USB	—	—	—	—	\$370
		<b>PVDMODDMT-1P1U</b> Double Configuration: 1 Power + 1 USB (2 paired units)	—	—	—	—	\$724
	Flip-up Power & Data Module available in matte black, matte white and aluminium	<b>PVDMODS-2P1U1D</b> Single Configuration: 2 outlets + 1 duplex USB + 1 data port	—	—	—	—	\$502
		<b>PVDMODD-2P1U1D</b> Double Configuration: 2 outlets + 1 duplex USB + 1 data port (2 paired units)	—	—	—	—	\$977

- Wire Management clips are white and attach by double sided tape which is included
- Cable Management Tray (INCMTXX) is available in two lengths, painted Eco Black and includes mounting hardware
- The cable drop has an optional 7' sleeve that is available in black, white, gray and beige

		Part number	W	Wt (lbs)	List price
	Mesh Cable Management Tray Silver	<b>TWMTRAY</b>	28"	—	\$133

	Cable Management Tray	<b>INCMT18</b>	18"	—	\$36
		<b>INCMT30</b>	30"	—	\$47

		Part number	W	Wt (lbs)	No cable sleeve/ neutral paint/ base price	With cable sleeve	Accent paint
	Cable Drop for use with both standing height and meeting tables with O legs	<b>TWCM</b>	—	—	\$60	+\$168	+\$8

# Finishes

June 2021

**inscape**

work for tomorrow

## INSCAPE SYSTEM FRAMES

Inscape System frames are powder-coated in scuff-resistant Eco-black epoxy. Clips, plates, plugs and bracketry are finished in black.

## TRIMS

Trims are available epoxy powder-coated in a smooth or textured finish.

## WORKSURFACES

Worksurfaces are available in Nuform Classic, Nuform Select and Laminate.

## NUFORM

Nuform is a thermofoil sheet that is continuously bonded to an MDF substrate. The sheet is surface-coated with a scratch resistant film. The underside of the worksurface is finished with low-pressure melamine. Nuform worksurfaces have optional pencil groove. No edge banding is required with Nuform because of its unique design, which wraps the foil to the underside of the worksurface. This eliminates the need for edge banding. Nuform is also available on tiles (ensure the application is reviewed for rules).

## NUFORM CLASSIC

Colorways	Product code
Sandstone	F123
Frosty White	F127
Designer White	F129
Calm Grey	F131
Pitch Black	F132
Honey Brown*	F09
Espresso*	F38
Swiss Elm*	F40
Blonde Maple*	F42
Barn Board*	F43

## NUFORM SELECT

Colorways	Product code
Rustic Plank*	F45
English Walnut*	F46
Natural Plywood*	F47
Nordic Ash*	F48
Ink Thread*	F49
Rose Gold Thread*	F50
Copper Thread*	F51
Fossil Slab	F52
Pearl Slab	F53
Stark Slab	F54
Alabaster Sandstone	F55
Aurora Marble	F56
Pure Oak*	F57
Holland Hickory*	F58
Essential Oak*	F59

\*Pattern is directional and will have limitation. 48"W standard and split corners are not possible.

## LAMINATE

Laminate is bonded to 1.25" thick particleboard. The underside of the worksurface is finished with a wood-fiber veneer backer. Worksurfaces specified with a laminate finish include a 2mm edge banding in a coordinating color. Plastic laminate tops do not have optional pencil groove.

Standard laminate finishes are prefixed with 'LCC' and standard low laminate storage finishes are prefixed with 'MCC'.

Code legend:

- LLC = HPL with matching edge band
- L1C = HPL with matching or plywood edge band
- OCC = HPL with self edge
- O1C = HPL with self edge
- MCC = LPL with matching edge band

Colorways	Product code	Edge color
Wild Cherry	LCC01	Rustic Cherry
Maple	LCC02	Fusion Maple
White	LCC07	Designer White
Pumice	LCC08	Beige
Antique White	LCC09	Warm White
Gray	LCC12/ MCC009	Folk Stone
Madagascar	LCC14	Madagascar
Asian Sand	LCC15	Asian Sand
River Cherry	LCC16	River Cherry
Wenge	LCC17	Wenge
Elegant White	LCC19	Frosty White
Neowalnut	LCC23	Neowalnut
Mangalore Mango	LCC29	Mangalore Mango
Pearwood	LCC30	Pearwood
Black	LCC33/ MCC012	Black
Walnut Heights	LCC35	Walnut Heights
Studio Teak	LCC36	Studio Teak
Slate Gray	LCC41	Slate Gray
Raven	LCC42	Raven
Dalia	LCC43/ MCC007	Dalia
Mimosa	LCC44/ MCC008	Mimosa
Inspiration	LCC45/ MCC010	Inspiration
Nova White	LCC46/ MCC001	Designer White
Storm	LCC47/ MCC011	Storm

Colorways	Product code	Edge color
White Lace	LCC48/ MCC013	White Lace
Chill	LCC49/ MCC014	Chill
Haze	LCC51/ MCC016	Haze
Dover White	LCC52	Dover White
Graphite	LCC53	Graphite

**LCC-18 is available but is reserved for existing customers due to its different edge banding.**

## GRADE 1 LAMINATE

Colorways	Product code	Edge color
Elegant White	L1C001	Plywood
Black	L1C002	Plywood
Slate Gray	L1C003	Plywood
Raven	L1C004	Plywood
White Ash	L1C005	White Ash
Weathered Ash	L1C006	Weathered Ash
Finnish Oak	L1C007	Finnish Oak
Fawn Cypress	L1C008	Fawn Cypress

## GRADE 2 LAMINATE

Colorways	Product code	Edge color
Natural Grain	L2C001	Natural Grain

## WOOD LEGS

These legs are available on Inscape Bench and the Tables Collection.

Colorways	Product code
Clear Oak	CLROAK
Black Oak	BLKOAK
Clear Maple	CLRMPL

## ACRYLIC

Colorways	Product code
Clear	CA
Frosted	FA
White	WH

## POLYCARBONATE

Colorways	Product code
Clear	CP
White	WP

## GLASS

Colorways	Product code
Clear	CL
Etched 1 Side	ET1
Etched 2 Sides	ET2
Grey	GRY

## TILES

Inscape System and Bench tiles are available fabric wrapped, epoxy powder coated and in Nuform finishes. Nuform tiles may be specified in finishes same as worksurfaces. Grain direction in Nuform is vertical. Tiles may be covered with our standard fabrics, or covered with COM.

Use of any COM must be approved by Inscape prior to acceptance of order. Refer to “Conditions of Sale, Orders involving Customer’s Own Material (COM)”.

Fabrics with an asterisk\* below, as well as any transparent (typically light colored) COM fabrics, will be subject to an upcharge due to additional costs associated with the manufacturing of the tile to eliminate transparency. The upcharge is included in specification tools, or through your Client Services Representative.

## SCRIM

Fabric wrapped tiles, including tackable tiles, are available in a variety of standard fabrics as well as COM. COM fabrics are subject to approval. White or extremely light colored COM fabrics will incur an upcharge of 25% to the tile pricing with which the fabric is being applied. This is due to special handling of the fabric and tiles, in addition to painting of the tiles. Light colored fabrics include; but are not limited to:

### ANCHORAGE

Colorways	Product code
White	U1437

### CAMEO

Colorways	Product code
Ivory	U2112

### GAMUT

Colorways	Product code
Chalk	U3300
Mist	U3338
Pumice	U3339
Pebble	U3340

### NETIQUETTE

Colorways	Product code
Bitmap	U1350
Chipset	U1351
Gamma	U1357

## OFF THE GRID

Colorways	Product code
Lava	U3110
Steam	U3112
Thermal	U3113
Solar	U3114
Fossil	U3116
Earthglow	U3117

## PACT

Colorways	Product code
Calla	U2176
Eureka	U2177
Toasty	U2182
Rubine	U2186

## SPRITE

Colorways	Product code
Snow	U5005

## WHISPER

Colorways	Product code
Dim	U1485
Ambience	U1486
Silence	U1487
Tranquility	U1488
Peep	U1499
Mellow	U1501
Spirit	U1508

Fabric patterns which are available in 54” and 55” width both have limitations on the sizes of tiles available. When being applied “Off the Blot” tile sizes longer than 42” are not available.

Patterns include: Gamut



GRADE 1 FABRICS

**ANCHORAGE**

Colorways	Product code
Green Apple	U1400
Red Delicious	U1401
Onyx	U1402
Slate	U1403
Amber	U1404
Willow	U1405
Flax	U1406
Angora	U1407
Green Olive	U1412
Goose	U1413
Cumin	U1414
Deep Water	U1415
Quarry Blue	U1416
Midnight	U1417
Sunshine	U1419
Asteroid	U1421
Coffee Bean	U1425
Geranium	U1426
Thistle	U1427
Chocolate	U1431
Lapis	U1432
Vanilla	U1434
Pumpkin	U1435
Wolf	U1436
White (scrim)	U1437

**NETIQUETTE**

Colorways	Product code
Bitmap (scrim)	U1350
Chipset (scrim)	U1351
Dashboard	U1352
Analog	U1353
Schema	U1354
Inkjet	U1355
Vector	U1356
Gamma (scrim)	U1357
Refresh	U1358
Pixel	U1359

**PEBBLE**

Colorways	Product code
Sindari	U1535
Nice	U1536
Waikiki	U1537
Siesta	U1538
South Beach	U1539
Schoolhouse	U1540
Mabua	U1541
Langkawi	U1542
Tenerife	U1543
Cape Cod	U1544
Maybay	U1545
Surfers Paradise	U1546
Negril	U1547
Papakolea	U1548
Chesil	U1549
Red Beach	U1550
Copacabana	U1551

**WHISPER**

Colorways	Product code
Dim (scrim)	U1485
Ambience (scrim)	U1486
Silence (scrim)	U1487
Tranquility (scrim)	U1488
Hush	U1489
Zen	U1490
Stillness	U1491
Mute	U1492
Serenity	U1493
Quiet	U1494
Muffle	U1495
Cloud	U1496
Lull	U1497
Reserve	U1498
Peep (scrim)	U1499
Baffle	U1500
Mellow (scrim)	U1501
Placid	U1502
Chant	U1503
Secret	U1504
Mum	U1505
Undertone	U1506
Mystery	U1507
Spirit (scrim)	U1508

GRADE 1 FABRICS (Continued)

**MEANDER**

Colorways	Product code
Sandshell	U1061
Overcast	U1062
Agate Taupe	U1063
Nightshadow	U1064

**UNIVERSE**

Colorways	Product code
Crème Brulee	U1000
Grey Mist	U1001
Wheat	U1002
Seneca	U1003
Milkyway	U1004
Mica	U1005
Cosmic	U1006
Depth	U1007

**QUATTRO**

Colorways	Product code
Chalk	U1889
Deep Crimson	U1890
Golden Orange	U1891
Granite	U1892
Hibiscus	U1893
Honeycomb	U1894
Khaki	U1895
Laguna	U1896
Leaf	U1897
Mallard	U1898
Mercury	U1899
Midnight Blue	U1900
Pumice	U1901
Skyway	U1902
Spring Green	U1903
Umber	U1904
Wheat	U1905

**CROSS CHECK**

Colorways	Product code
Biscuit	U1552
Blue Ribbon	U1553
Bottle	U1554
Dove	U1555
Evergreen	U1556
Imperial	U1557
Lime	U1558
Marine	U1559
Otter	U1560
Paradise	U1561
Peacock	U1562
Platinum	U1563
Plumberry	U1564
Red Baron	U1565
Slate Black	U1566
Stone	U1567
Sunshine	U1568
Taupe	U1569
Vermillion	U1570

GRADE 2 FABRIC

**CAMEO**

Colorways	Product code
Almond	U2110
Metal	U2111
Ivory (scrim)	U2112
Coffee	U2113
Smoke	U2114
Stone	U2115
Mist	U2116

**PRONTO SOLID**

Colorways	Product code
Drift	U1200
Windblown	U1201
Erosion	U1202
Clear Sky	U1210
Raven	U1215
Darkness	U1220
Breeze	U1280

**PUNCH CARD**

Colorways	Product code
Alabaster	U2060
Carbon	U2061
Putty	U2062
Silver Lining	U2063
Crisp	U2064
Sky	U2065
Crimson	U2066
Orange	U2067
Navy	U2068
Cadet	U2069
Burgundy	U2070
Peat	U2071
Abyss	U2072

**CURTAIN CALL**

Colorways	Product code
Latte	U2100
Desert	U2101
Dove	U2102
Pebble	U2103
Tawny	U2104
Sea	U2105

**PROVERB**

Colorways	Product code
Anchor	U1740
Armor	U1741
Basalt	U1742
Buff	U1743
Cinder	U1744
Crystal	U1745
Linen	U1746
Mist	U1747
Oyster	U1748
Rye	U1749
Steel	U1750
Storm	U1751

GRADE 2 FABRIC (Continued)

**PACT**

Colorways	Product code
Putty	U2175
Calla (scrim)	U2176
Eureka (scrim)	U2177
Lime	U2178
Coastal	U2179
Nectar	U2180
Dragon	U2181
Toasty (scrim)	U2182
Fern	U2183
Azure	U2184
Delft	U2185
Rubine (scrim)	U2186
Taupe	U2187
Dove	U2188
Aloe	U2189
Harbour	U2190
Tanzanite	U2191
Roma	U2192
Lily	U2193
Sketch	U2194
Patina	U2195
Roast	U2196
Midnight	U2197

**GLINT**

Colorways	Product code
Barley	U1658
Caspian	U1659
Column	U1660
Gobi	U1661
Gypsum	U1662
Note	U1663
Pearl	U1664
Pumice	U1665
Relic	U1666
Rune	U1667
Serene	U1668
Shale	U1669
Sisal	U1670
Turret	U1671
Vera	U1672

**SCRIPT**

Colorways	Product code
Almond	U1752
Charcoal	U1753
Feldspar	U1754
Flint	U1755
Nectar	U1756
Patina	U1757
Pebble	U1758
Sand	U1759
Shadow	U1760
Slate	U1761
Sterling	U1762
Taupe	U1763
Zinc	U1764

GRADE 3 FABRIC

**DASHING**

Colorways	Product code
Antique Sage	U3180
Bespoke Tan	U3181
Dapper Grey	U3182
Gentee Beige	U3183
Polish Slate	U3184
Refine Marble	U3185
Classic Silver	U3186

**OFF THE GRID**

Colorways	Product code
Lava (scrim)	U3110
Flora	U3111
Steam (scrim)	U3112
Thermal (scrim)	U3113
Solar (scrim)	U3114
Woodchip	U3115
Fossil (scrim)	U3116
Earthglow (scrim)	U3117
Hydro	U3118
Flame	U3119
Tidal	U3120

**GAMUT**

Colorways	Product code
Chalk (scrim)	U3300
Nutmeg	U3303
Mango	U3308
Cherry	U3313
Port	U3314
Cerulean	U3317
Pool	U3318
Macaw	U3319
Deep Ocean	U3320
Spruce	U3321
Navy	U3322
Ink	U3323
Olive	U3326
Concord	U3334
Solar	U3335
Persimmon	U3337
Mist (scrim)	U3338
Pumice (scrim)	U3339
Pebble (scrim)	U3340

GRADE 3 FABRIC (Continued)

**MILLENNIUM**

Colorways	Product code
Aglow	U1628
Amber	U1629
Anchor	U1630
Cascade	U1631
Cavern	U1632
Cerise	U1633
Clean	U1634
Coastal	U1635
Copper	U1636
Crisp	U1637
Electric	U1638
Geode	U1639
Lush	U1640
Mocha	U1641
Monument	U1642
Nector	U1643
Onyx	U1644
Orchid	U1645
Peridot	U1646
Plateau	U1647
Pool	U1648
Pyrite	U1649
Safari	U1650
Sapphire	U1651
Spark	U1652
Steel	U1653
Tanzanite	U1654
Thrill	U1655
Voyage	U1656
Zinc	U1657

**ODYSSEY**

Colorways	Product code
Alloy	U1765
Amp	U1766
Breeze	U1767
Captain	U1768
Carbon	U1769
Cedar	U1770
Craft	U1771
Cruise	U1772
Dijon	U1773
Eggplant	U1774
Emerald	U1775
Fossil	U1776
Ink	U1777
Inlet	U1778
Iris	U1779
Kiss	U1780
Linen	U1781
Lively	U1782
Maritime	U1783
Nettle	U1784
Oliver	U1785
Opaque	U1786
Primary	U1787
Roast	U1788
Rue	U1789
Sangria	U1790
Skim	U1791
Smith	U1792
Tinge	U1793
Western	U1794

GRADE 3 FABRIC (Continued)

**TRADITION**

Colorways	Product code
Ash	U1795
Branch	U1796
Class	U1797
Distant	U1798
Flirt	U1799
FronD	U1800
Grain	U1801
Hedge	U1802
Hidden	U1803
Isle	U1804
Jazz	U1805
Kelly	U1806
Latte	U1807
Malbec	U1808
Miller	U1809
Mist	U1810
Peel	U1811
Plated	U1812
Regal	U1813
Sly	U1814
Soar	U1815
Soy	U1816
Spiced	U1817
Sprout	U1818
Sterling	U1819
Sun	U1820
Tango	U1821
Theater	U1822
Wash	U1823
Weld	U1824

**BEEHAVE**

Colorways	Product code
Azure	U1825
Black	U1826
Carnelian	U1827
Clementine	U1828
Concord	U1829
Currant	U1830
Gris	U1831
Java	U1832
Lapis	U1833
Lemon	U1834
Pear	U1835
Pine	U1836
Plum	U1837
Slate	U1838

**CADENCE**

Colorways	Product code
Citrine	U1863
Coral	U1864
Garnet	U1865
Jade	U1866
Jet	U1867
Lapis	U1868
Opal	U1869
Pearl	U1870
Peridot	U1871
Quartz	U1872
Ruby	U1873
Sapphire	U1874
Topaz	U1875
Turquoise	U1876

GRADE 3 FABRIC (Continued)

**OPTIC**

Colorways	Product code
Ash	U1907
Brown Bear	U1908
Coal	U1909
Elephant	U1910
Fieldstone	U1911
Green Apple	U1912
Mulberry	U1913
Mushroom	U1914
Ocean	U1916
Red	U1917
Springtime	U1918
Sunrise	U1919
Tangerine	U1920
Yale	U1921

GRADE 4 FABRIC

**NO PATTERNS FALL INTO GRADE 4 AT THIS TIME.**

**PRISM**

Colorways	Product code
Alabaster	U1690
Asparagus	U1691
Café Au Lait	U1692
Caramel	U1693
Caribbean	U1694
Cerulean	U1695
Charcoal	U1696
Claret	U1697
Clay	U1698
Clementine	U1699
Cornflower	U1700
Dove	U1701
Espresso	U1702
Indigo	U1703
Kale	U1704
Lipstick	U1705
Mocha	U1706
Olive	U1707
Onyx	U1708
Plum	U1709
Raisin	U1710
Stone	U1711
Tomato	U1712
Topaz	U1713
Zinc	U1714



GRADE 5 FABRIC

**SPRITE**

Colorways	Product code
Linen	U5000
Powder	U5001
Khaki	U5002
Kiwi	U5003
Harvest	U5004
Snow (scrim)	U5005

GRADE 6 FABRIC

**CROSSWEAVE**

Colorways	Product code
Flax	UW1101
Antelope	UW1102
Mountain	UW1103
Straw	UW1104
Cantaloupe	UW1105
Tangelo	UW1106
Shiraz	UW1107
Flower	UW1108
Alfalfa	UW1109
Parsley	UW1110
Freshwater	UW1111
Lake	UW1112
Atlantic	UW1113
Soapstone	UW1114
Penguin	UW1115
Seal	UW1116

GRADE 7 FABRIC

**NO PATTERNS FALL INTO GRADE 7 AT THIS TIME.**

- Open House is an upholstery version of our graded Anchorage panel fabric. You can color match with your panel tile selection by choosing the ‘same name’ color from the Open House collection
- COL ‘Customers’ Own Leather - COL is available and will be quoted on a per order basis
- Contrasting Top Stitching - ‘White’ contrasting top stitching is available at ‘no upcharge’. Please specify at time of order placement

GRADE A  
**OPEN HOUSE**

Pattern	Product code
Green Apple	U1400
Red Delicious	U1401
Onyx	U1402
Slate	U1403
Amber	U1404
Willow	U1405
Straw	U1406
Angora	U1407
Green Olive	U1412
Goose	U1413
Cumin	U1414
Deep Water	U1415
Quarry Blue	U1416
Midnight	U1417
Sunshine	U1419
Asteroid	U1421
Coffee Bean	U1425
Geranium	U1426
Thistle	U1427
Fossil	U1431
Lapis	U1432
Vanilla	U1434
Pumpkin	U1435
Wolf	U1436
Birch	UC2086
Eucalypt	UC2088
Graphite	UC2090
Cobalt	UC2091
Mulberry	UC2092
Pineneedle	UC2095
Aubergine	UC2096

**PEBBLE**

Pattern	Product code
Sindari	U1535
Nice	U1536
Waikiki	U1537
Siesta	U1538
South Beach	U1539
Schoolhouse	U1540
Mabua	U1541
Langkawi	U1542
Tenerife	U1543
Cape Cod	U1544
Maybay	U1545
Surfers Paradise	U1546
Negril	U1547
Papakolea	U1548
Chesil	U1549
Red Beach	U1550
Copacabana	U1551

**PUNCH CARD**

Pattern	Product code
Alabaster	U2060
Carbon	U2061
Putty	U2062
Silver Lining	U2063
Crisp	U2064
Sky	U2065
Crimson	U2066
Orange	U2067
Navy	U2068
Cadet	U2069
Burgundy	U2070
Peat	U2071
Abbyss	U2072

GRADE A (Continued)

**QUATTRO**

Pattern	Product code
Chalk	U1889
Deep Crimson	U1890
Golden Orange	U1891
Granite	U1892
Hibiscus	U1893
Honeycomb	U1894
Khaki	U1895
Laguna	U1896
Leaf	U1897
Mallard	U1898
Mercury	U1899
Midnight Blue	U1900
Pumice	U1901
Skyway	U1902
Spring Green	U1903
Umber	U1904
Wheat	U1905

**PROVERB**

Pattern	Product code
Anchor	U1740
Armor	U1741
Basalt	U1742
Buff	U1743
Cinder	U1744
Crystal	U1745
Linen	U1746
Mist	U1747
Oyster	U1748
Rye	U1749
Steel	U1750
Storm	U1751

**CROSS CHECK**

Pattern	Product code
Biscuit	U1552
Blue Ribbon	U1553
Bottle	U1554
Dove	U1555
Evergreen	U1556
Imperial	U1557
Lime	U1558
Marine	U1559
Otter	U1560
Paradise	U1561
Peacock	U1562
Platinum	U1563
Plumberry	U1564
Red Baron	U1565
Slate Black	U1566
Stone	U1567
Sunshine	U1568
Taupe	U1569
Vermillion	U1570

GRADE A (Continued)

**GLINT**

Pattern	Product code
Barley	U1658
Caspian	U1659
Column	U1660
Gobi	U1661
Gypsum	U1662
Note	U1663
Pearl	U1664
Pumice	U1665
Relic	U1666
Rune	U1667
Serene	U1668
Shale	U1669
Sisal	U1670
Turret	U1671
Vera	U1672

**SCRIPT**

Pattern	Product code
Almond	U1752
Charcoal	U1753
Feldspar	U1754
Flint	U1755
Nectar	U1756
Patina	U1757
Pebble	U1758
Sand	U1759
Shadow	U1760
Slate	U1761
Sterling	U1762
Taupe	U1763
Zinc	U1764

**MILLENNIUM**

Pattern	Product code
Aglow	U1628
Amber	U1629
Anchor	U1630
Cascade	U1631
Cavern	U1632
Cerise	U1633
Clean	U1634
Coastal	U1635
Copper	U1636
Crisp	U1637
Electric	U1638
Geode	U1639
Lush	U1640
Mocha	U1641
Monument	U1642
Nector	U1643
Onyx	U1644
Orchid	U1645
Peridot	U1646
Plateau	U1647
Pool	U1648
Pyrite	U1649
Safari	U1650
Sapphire	U1651
Spark	U1652
Steel	U1653
Tanzanite	U1654
Thrill	U1655
Voyage	U1656
Zinc	U1657

GRADE A (Continued)

**BEEHAVE**

Pattern	Product code
Azure	U1825
Black	U1826
Carnelian	U1827
Clementine	U1828
Concord	U1829
Currant	U1830
Gris	U1831
Java	U1832
Lapis	U1833
Lemon	U1834
Pear	U1835
Pine	U1836
Plum	U1837
Slate	U1838

**ODYSSEY**

Pattern	Product code
Alloy	U1765
Amp	U1766
Breeze	U1767
Captain	U1768
Carbon	U1769
Cedar	U1770
Craft	U1771
Cruise	U1772
Dijon	U1773
Eggplant	U1774
Emerald	U1775
Fossil	U1776
Ink	U1777
Inlet	U1778
Iris	U1779
Kiss	U1780
Linen	U1781
Lively	U1782
Maritime	U1783
Nettle	U1784
Oliver	U1785
Opaque	U1786

Pattern	Product code
Primary	U1787
Roast	U1788
Rue	U1789
Sangria	U1790
Skim	U1791
Smith	U1792
Tinge	U1793
Western	U1794

**TRADITION**

Pattern	Product code
Ash	U1795
Branch	U1796
Class	U1797
Distant	U1798
Flirt	U1799
Fronde	U1800
Grain	U1801
Hedge	U1802
Hidden	U1803
Isle	U1804
Jazz	U1805
Kelly	U1806
Latte	U1807
Malbec	U1808
Miller	U1809
Mist	U1810
Peel	U1811
Plated	U1812
Regal	U1813
Sly	U1814
Soar	U1815
Soy	U1816
Spiced	U1817
Sprout	U1818
Sterling	U1819
Sun	U1820
Tango	U1821
Theater	U1822
Wash	U1823
Weld	U1824

GRADE A (Continued)

**CADENCE**

Pattern	Product code
Citrine	U1863
Coral	U1864
Garnet	U1865
Jade	U1866
Jet	U1867
Lapis	U1868
Opal	U1869
Pearl	U1870
Peridot	U1871
Quartz	U1872
Ruby	U1873
Sapphire	U1874
Topaz	U1875
Turquoise	U1876

**OPTIC**

Pattern	Product code
Ash	U1907
Brown Bear	U1908
Coal	U1909
Elephant	U1910
Fieldstone	U1911
Green Apple	U1912
Mulberry	U1913
Mushroom	U1914
Ocean	U1916
Red	U1917
Springtime	U1918
Sunrise	U1919
Tangerine	U1920
Yale	U1921

**PRISM**

Pattern	Product code
Alabaster	U1690
Asparagus	U1691
Café Au Lait	U1692
Caramel	U1693
Caribbean	U1694
Cerulean	U1695
Charcoal	U1696
Claret	U1697
Clay	U1698
Clementine	U1699
Cornflower	U1700
Dove	U1701
Espresso	U1702
Indigo	U1703
Kale	U1704
Lipstick	U1705
Mocha	U1706
Olive	U1707
Onyx	U1708
Plum	U1709
Raisin	U1710
Stone	U1711
Tomato	U1712
Topaz	U1713
Zinc	U1714

**INTUITION**

Pattern	Product code
Admiral	U1849
Bisque	U1850
Charcoal	U1851
Coral	U1852
Hickory	U1853
Honey	U1854
Ochre	U1855
Peacock	U1856
Platinum	U1857
Sage	U1858
Sand	U1859
Scarlet	U1860
Slate	U1861
Viridian	U1862

GRADE A (Continued)

**FEDORA**

Pattern	Product code
Aegean	U1583
Aquamarine	U1584
Bitumen	U1585
Cactus	U1586
Charcoal	U1587
Citron	U1588
Dapper	U1589
Dew	U1590
Espresso	U1591
Eucalyptus	U1592
Fawn	U1593
Indigo	U1594
Light Grey	U1595
Midnight	U1596
Mink	U1597
Opal	U1598
Persimmon	U1599
Pewter	U1600
Plumberry	U1601
Purple	U1602
Ruby	U1603
Tangelo	U1604
Tomato	U1605
Topaz	U1606
Winter	U1607

**RANCHERO**

Pattern	Product code
Basil	U1922
Black	U1923
Brandy	U1924
Chocolate	U1925
Driftwood	U1926
Ecru	U1927
Greige	U1928
Lipstick	U1929
Navy	U1930
Nickel	U1931
Sapphire	U1932
Sepia	U1933
Slate	U1934
Thunder	U1935

**FLORENTINO**

Pattern	Product code
Bark	U1936
Basil	U1937
Biscuit	U1938
Bluejay	U1939
Caramel	U1940
Chili	U1941
Cream	U1942
Dijon	U1943
Dove	U1944
Fern	U1945
Jet	U1946
Jonquil	U1947
Khaki	U1948
Latte	U1949
Lipstick	U1950
Mango	U1951
Marine	U1952
Mocha	U1953
Mushroom	U1954
Plum	U1955
Sable	U1956
Sapphire	U1957
Scarlet	U1958
Sepia	U1959
Slate	U1960
Turquoise	U1961
Willow	U1962

GRADE A (Continued)

**KEY LARGO**

Pattern	Product code
Aegean	U1968
Cayenne	U1969
Chocolate	U1970
Crimson	U1971
Ebony	U1972
Gold Coast	U1973
Graphite	U1974
Jonquil	U1975
Jungle	U1976
Khaki	U1977
Nassau	U1978
Palm	U1979
Parchment	U1980
Pear	U1981
Quarry	U1982
Raspberry	U1983
Sand	U1984
Sandstone	U1985
Tangerine	U1986
Toast	U1987
Ultramarine	U1988
Wheat	U1989

GRADE B

**CROSSWEAVE**

Pattern	Product code
Flax	UW1101
Antelope	UW1102
Mountain	UW1103
Straw	UW1104
Cantaloupe	UW1105
Tangelo	UW1106
Shiraz	UW1107
Flower	UW1108
Alfalfa	UW1109
Parsley	UW1110
Freshwater	UW1111
Lake	UW1112
Atlantic	UW1113
Soapstone	UW1114
Penguin	UW1115
Seal	UW1116



GRADE B (Continued)

**TWEED MULTI**

Pattern	Product code
Taupe	UW1001
Tan	UW1002
Dark Taupe	UW1003
Yellow	UW1004
Pink	UW1005
Flame	UW1006
Medium Blue	UW1007
Turquoise	UW1008
Dark Blue	UW1009
Green	UW1010
Orange	UW1011
Light Grey	UW1012
Medium Grey	UW1013

**EVOKE**

Pattern	Product code
Breeze	U1877
Cerise	U1878
Flax	U1879
Graphite	U1880
Grey Mist	U1881
Iris	U1882
Mahogany	U1883
Natural	U1884
Noir	U1885
Pacific	U1886
Pear	U1887
Terracotta	U1888

**QUADRILLE**

Pattern	Product code
Fair	UC1001
Cabaret	UC1002
Gambol	UC1003
Leisure	UC1004
Regalia	UC1005
Spring	UC1006
Zest	UC1007
Fiesta	UC1008
Carnival	UC1009
Spree	UC1010
Jubilee	UC1011
Opus	UC1012
Masquerade	UC1013
Soiree	UC1014
Revelry	UC1015
Escapade	UC1016
Shenanigan	UC1017

GRADE C  
**NO PATTERNS FALL INTO GRADE C AT THIS TIME.**

GRADE D  
**TINY HERRINGBONE**

Pattern	Product code
Tan	UW4201
Brown	UW4202
Blue Green	UW4203
Blue	UW4204
Medium Grey	UW4205
Dark Charcoal	UW4206

COM CALCULATOR

Cushion Width	Cushion Depth	Cushion Thickness	Fabric Orientation	Back to Back Lateral	Fabric Quantity (run inches)
15"	18"	1.25"	Off the bolt		28
15"	22"	1.25"	Off the bolt		32
15"	28"	1.25"	Off the bolt		38
15"	18.75"	1.25"	Off the bolt		29
15"	22.75"	1.25"	Off the bolt		33
15"	28.75"	1.25"	Off the bolt		39
15"	36"	1.25"	Off the bolt	• (Planna Peds)	47
30"	18"	1.25"	Off the bolt		28
30"	36"	1.25"	Off the bolt	•	47
36"	18"	1.25"	Off the bolt		29
36"	36"	1.25"	Off the bolt	•	47
42"	18"	1.25"	Off the bolt		29
42"	36"	1.25"	Off the bolt	•	47
60"	18"	1.25"	Off the bolt		N/A
66"	18"	1.25"	Off the bolt		N/A
72"	18"	1.25"	Off the bolt		N/A
78"	18"	1.25"	Off the bolt		N/A
84"	18"	1.25"	Off the bolt		N/A
15"	18"	1.25"	Railroad		25
15"	22"	1.25"	Railroad		25
15"	28"	1.25"	Railroad		25
15"	18.75"	1.25"	Railroad		25
15"	22.75"	1.25"	Railroad		25
15"	28.75"	1.25"	Railroad		25
15"	36"	1.25"	Railroad		25
30"	18"	1.25"	Railroad		41
30"	36"	1.25"	Railroad	•	41
36"	18"	1.25"	Railroad		47
36"	36"	1.25"	Railroad	•	47
42"	18"	1.25"	Railroad		52
42"	36"	1.25"	Railroad	•	52
60"	18"	1.25"	Railroad		69
66"	18"	1.25"	Railroad		75
72"	18"	1.25"	Railroad		83
78"	18"	1.25"	Railroad		87
84"	18"	1.25"	Railroad		93

HOW TO CALCULATE COM YARDAGE REFER TO 'COM FABRIC CALCULATOR'

INPUT

1. Select cushion width and depth appropriate to your specification
2. Select cushion thickness
3. Select fabric orientation (refer to 'Cushion Layup' sketches)
4. Find the corresponding fabric quantity in 'running inches' from the table

CALCULATION

1. Multiply the number of cushions required by the fabric quantity in 'running inches' off of the table
2. Divide the number of running inches by 36 to convert to yardage required. Round up to the nearest half yard.
3. If a pattern repeat is required, ordering a sample cushion is advised to determine fabric yardage and any applicable upcharges. A layup instruction will also be required for review.

EXAMPLE:

- Storage with Handles Pedestal

- Quantity – 31 cushions

- 15" wide x 22" deep x 1.25" thick

- COM fabric is a solid colour and has no directional weave; best fabric usage is 'off the bolt' orientation.

Note: Highlighted areas on the COM Calculator indicates 2 cushion yield per piece.

CALCULATION:

32 running inches x 16 cushions = 512" of fabric required

512" divided by 36 = 14yds, 8"

Total fabric required = 14 ½ yards (rounded up)

ADDITIONAL SPECIFICATION INFORMATION:

1. Pedestal Cushion Depth options vary by product profile and application. Ensure you are referencing the correct dimensions
2. Lateral Cushion Depth options vary by application Ensure you are referencing the correct dimensions
3. Fabric Quantity is based on a 54" wide roll
4. Highlighted rows yield 2 cushions per fabric quantity listed
5. All directional/patterned fabrics (Graded or COM) require cushion layup instructions with order placement. Depending on layup additional fabric may be required and upcharges may apply. If layup instructions are not provided the layup that maximizes the production yield will be chosen. (Refer to the layup diagrams)
6. For any cushion sizes not listed on the COM Calculator or for further information please contact your Client Service Representative for assistance

FABRIC LAYUP

LATERAL CUSHION FABRIC LAYUP

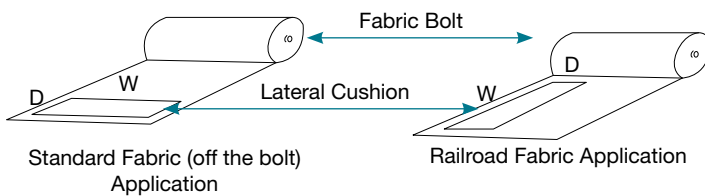

PEDESTAL CUSHION FABRIC LAYUP

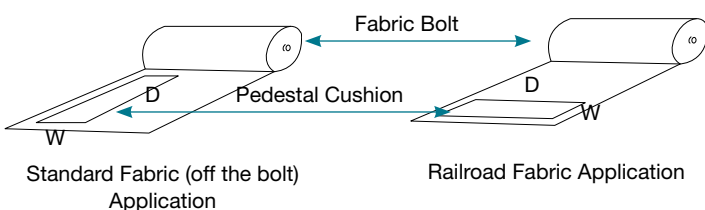

For COM fabric testing on Adjustable Framed Table Mounted Screens (MST37XX) and tiles, please provide the following to your SRT – Customer Experience specialist:

- (1) memo sample of the fabric to be tested
- (1) yard of fabric to be tested
- Product Code that the fabric is to be applied to

Testing turnaround times are 3 to 5 days upon receipt of memos samples/yardage. Your Customer Experience specialist will provide the results of the application testing.

For COM fabric testing on all other products including cushions, divider screens and risers, please provide the following to your SRT – Customer Experience specialist:

- (4) memo samples of the fabric to be tested
- Product Code that the fabric is to be applied to

General testing turnaround times are 48 to 72 hours upon receipt of memos samples. Your Customer Experience specialist will provide the results of the application testing.

**PAINT CODE MATRIX**

Painted System and Bench components include; tiles, trim, support brackets, accessories, legs and storage.

The following prefixes will be referenced on order acknowledgements:

<b>E</b>	indicates standard paint on all filing and storage items
<b>ET</b>	indicates standard textured paint on all filing and storage items, a 10% upcharge is applicable to the net value of the product
<b>EA</b>	indicates standard accent paint on all filing and storage items
<b>P</b>	indicates standard paint on all other items
<b>PT</b>	indicates standard textured paint on all other items, a 10% upcharge is applicable to the net value of the product
<b>PA</b>	indicates standard accent paint on all other items

**CUSTOM (NON-STANDARD) COLORS**

Inscape offers colors matched to a customer's specification when possible. This matching is done through a database of over 3,000 existing color formulas or the development of a new custom color. A \$324 net fee applies for each custom color per order. In addition, Custom Premium colors (bright whites and bright colors; textured paints; and reflection paints that use mica, aluminum or special chemical to create their reflective properties) will be subject to a 10% upcharge to the net value of the product per order.

**MULTI-COLOR CABINETS**

For multi-color cabinets where the case is one color and the drawer fronts are a second color, a \$270 net fee applies per color per order. (Tie bars and reference shelves will be painted the same color as the case.). This charge is applicable for multi-colour applications using Neutral, Accent or Custom paints. If using an Accent paint on a Multi-color cabinet, the standard Accent paint upcharge for the unit will also be applicable.

**NOTE: Multi-color cabinets are not available on Storage with Handles.**

**TEXTURED COLORS**

- Available
- Unavailable

**NOTE: A 10% UPCHARGE IS APPLICABLE TO THE NET VALUE OF THE PRODUCT FOR TEXTURED COLORS.**

**NEUTRAL PAINT COLLECTION**

Name	Color code	Textured colors
Bisque	004	●
Chinook	010	○
Onyx	013	●
Frost	022	●
Arctic	023	●
Champagne	024	●
Titanium	052	●
Mushroom	055	○
Krypton Reflections	063	●
Cinder Reflections	066	●
Soapstone	112	●
Warm White	121	●
Mist	122	○
Sandstone	123	●
Light Taupe	124	●
Medium Gray	126	●
Nickel Reflections	127	●
Slate Reflections	128	●
Quartz	160	○
Glacier White	168	○
Charcoal Gray	205	●
Pebble Gray	217	●
Deep White	223	●
Mocha	255	○
Latte	274	○
Juniper Reflections	281	○
Quicksilver Reflections	282	○
Sunstone Reflections	284	●
Aluminum Leaf	290	●
Sasha	300	○
Elson	301	○
Shade	302	○
Anonymous	303	○
Urban	304	○
Dorian	305	○
Dover	306	○
Jubilee	307	○
Softer Tan	308	○
Storm Cloud	309	○
Rice Grain	310	○
Ramie	311	○

**NEUTRAL PAINT COLLECTION** (Continued)

Name	Color code	Textured colors
Favorite Tan	312	
High Tea	314	
Stone Reflections	315	
Dovetail Reflections	316	
Yorkshire	317	
Coriander	318	
Snowcap	319	
Salem	320	
Burnt Sierra	321	
Drizzle	322	
Scroll	323	
Cumin	324	
Seagull	325	
Smoke	326	
Gunpowder Blue	327	
Starlight Silver	329	
Martini Reflections	330	
Laminate White	332	
Steel Wool	334	
Kettle Black	335	
White Velvet	336	
Simply White	337	
Dark Bronze **	338	

**\*\*Due to the semi-transparent nature of clear coat paint finish, the substrate material, as well as markings from the manufacturing process may be visible through the finish. For warranty information, please refer to the Inscape North American warranty on [inscapesolutions.com](https://www.inscapesolutions.com)**

**ACCENT PAINT COLLECTION**

Standard colors are prefixed with a 'A'.

Name	Color code
Peony	A339
Lilac	A340
Amethyst	A341
Mulberry	A342
Plum	A343
Citrine	A344
Canary	A345
Lotus	A346
Monarch	A347
Coral	A348
Amaryllis	A349
Apricot	A350
Cantaloupe	A351
Poppy	A352
Caliche	A353
Obsidian	A354
Dahlia	A355
Honeydew	A356
Sage	A357
Hummingbird	A358
Spring	A359
Marimo	A360
Fern	A361
Azure	A362
Wave	A363
Lapis Blue	A364
Atoll	A365
Papillon	A366
Lagoon	A367
Night Sky	A368
Aqua	A369
Inscape Teal	A370

# Care & Maintenance

June 2021

**inscape**

work for tomorrow

# Care & Maintenance

The following information provides general guidelines for cleaning and maintaining Inscape products including: Worksurfaces, Tables, Supports, Tiles, Trim, Screens, Storage and Accessories.

## NUFORM

Nuform surfaces are manufactured by thermoforming a polymer sheet around an MDF substrate. The polymer sheet is surface-coated with a scratch resistant film.

- For general cleaning, use warm soapy water, a mild, non-abrasive household cleanser or a 10-20% Bleach solution
- To remove stains like permanent marker use a cotton ball dampened with Acetone
- On tougher stains, use a cotton ball dampened with methyl hydrate
- Do not use abrasive cleansers or highly solvent based chemicals such as gasoline, acetone or toluene as they may scratch or affect the surface appearance
- Do not place hot appliances directly on Nuform surfaces
- Although Nuform is scratch resistant, avoid dragging sharp objects across the surface
- Light scratches may be buffed from the foil surface by using a 400-600 grit wet sandpaper under light hand pressure in circular motions or by using a 3M Scotch Brite Pad (green color only) under light hand pressure in circular motions. Note: Under no circumstances should power buffing tools be used
- Chips and deep scratches may be repaired by a professional touch-up service. Minor imperfections should be addressed immediately as neglect can result in more serious problems that could void the warranty
- Optimal storage temperature range for Nuform surfaces is 41°F to 86°F
- Avoid exposure to extreme heat, cold and humidity

## LAMINATE

High pressure laminate is available for use on surfaces, selected accessories and is optional on laminate storage door fronts. Low pressure laminate is available for use on laminate storage cases and door fronts. Both laminate options are laminated to particleboard and includes a color coordinated edge banding.

- Dust off laminated surfaces prior to cleaning
- For general cleaning, use a damp cloth with warm soapy water or a mild, non-abrasive household cleanser. Do not use a cleanser with acids or alkalis as this will damage the surface. Remember to wipe the surface with the grain using a dry soft cloth.
- An eraser may assist with removing ink marks
- Isopropyl Alcohol or Rubbing Alcohol may be used to clean laminate surfaces
- Do not use abrasive cleaners or bleaching cleansers as they may scratch or affect the surface appearance
- Take note that any product with Hydrochloric, Sulfuric, or Phosphoric acid may permanently damage the surface
- Although high pressure plastic laminates are resistant to scratching and wear, avoid dragging sharp objects across the surface
- Do not place hot appliances directly onto laminate surfaces
- Avoid exposure to extreme heat, cold or humidity



# Care & Maintenance

## WOOD

Wood is an option on legs and supports. Like all natural products, wood legs may vary slightly in grain, texture and color. For this reason, minor variations between pieces can be expected.

- Dust surface with a dry cloth in the direction of the grain
- For dirtier surfaces, use warm soapy water and a soft cloth
- Do not use abrasive cleaning products as they may scratch or affect the surface appearance
- Although waxing and polishing is not necessary, waxing and polishing products may be applied if care is taken to avoid wax build-up which may cloud the finish
- Exposure to strong sunlight should be avoided since fading may result
- Avoid exposure to extreme heat, cold or humidity
- Avoid dragging sharp objects across the surface
- Chips and scratches may be repaired by a professional touch-up service

## FABRIC

- Vacuum or lightly brush panel fabrics to remove dirt build-up
- Promptly remove stains by blotting, not rubbing the fabric to retain pile texture
- Fabric may be cleaned with mild water-free solvents or water-based cleaning agents or foam
- Always follow the manufacturer's instructions and test clean a non-visible area first

## PAINTED METAL

- Clean with a soft damp cloth and warm soapy water
- Gently rub tougher grime away with a mild, non-abrasive household cleaning product
- Paint touch up kits are available for minor repairs
- **Note:** Most consumer cleaners may be used, always spot test products to ensure no hazing or softening of the coated film takes place

## GLASS

- Clean glass with a mild window cleaner

## ACRYLIC

- Clean acrylic with a clean soft cloth and warm soapy water

## WHITEBOARDS/DRY ERASE BOARDS

- Use only dry erase markers on boards
- Clean boards with an eraser or microfiber cloth and cleaner that is formulated for whiteboards
- Inscape recommends using "Sanford Expo Dry Erase Markers" and "Sanford Whiteboard Cleaner"

## BIN/SHELF-MOUNTED TASK LIGHT FIXTURES

- Include a 120V/60HZ magnetic ballast. Replacement ballasts can be purchased from any electrical supply store

# Transit Times

June 2021

**inscape**

work for tomorrow

# Care & Maintenance

## UNITED STATES:

---

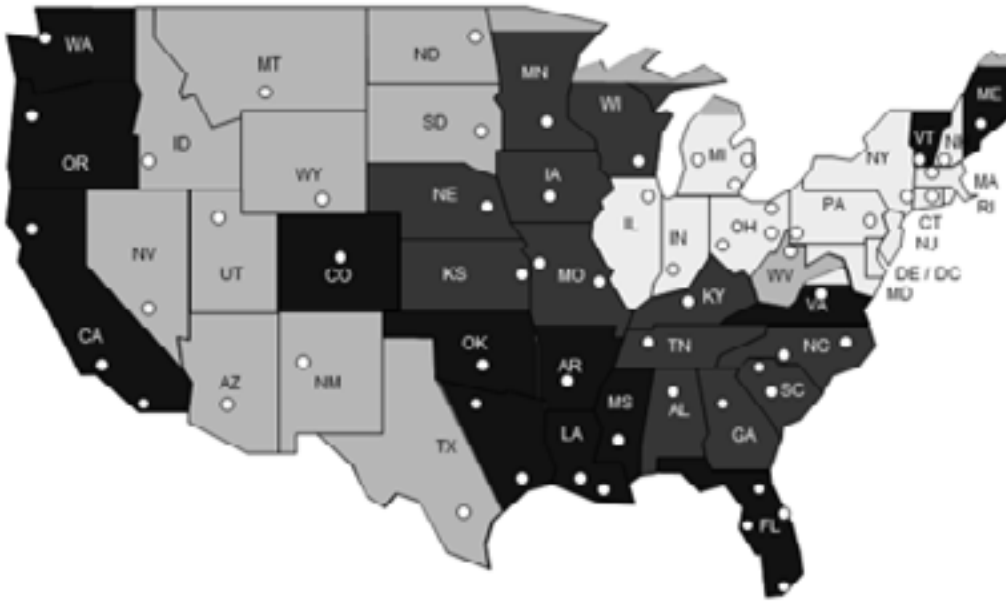

### FROM DATE OF DEPARTURE:

#### 3-5 Day Transit

NH, MA, CT, NY, RI, PA, MD, DE, DC, OH, IN, IL, MI, NJ

#### 4-6 Day Transit

SC, GA, AL, TN, NC, MO, KS, IA, NE, MN, WI, KY

#### 5-7 Day Transit

CO, CA, FL, OR, WA, TX, VA, VT, ME, MS, LA, AR, OK

#### 5-8 Day Transit

WV, MT, ND, SD, ID, WY, UT, NV, AZ, NM, TX

\*Date of departure may be any day in the acknowledged ship week ending.

**inscape**

67 Toll Road  
Holland Landing, Ontario  
L9N 1H2 Canada

**T** 905 836 7676

**F** 905 836 6000

**Toll Free** 1 866 467 2273

[myinscape.com](http://myinscape.com)

© Inscape Corporation 2021™

® Trademarks of Inscape Corporation. Patents may be pending. Certain names, words, logos and graphics or designs contained herein are trademarks or service marks of Inscape Corporation.