

SPIDI® HookFix

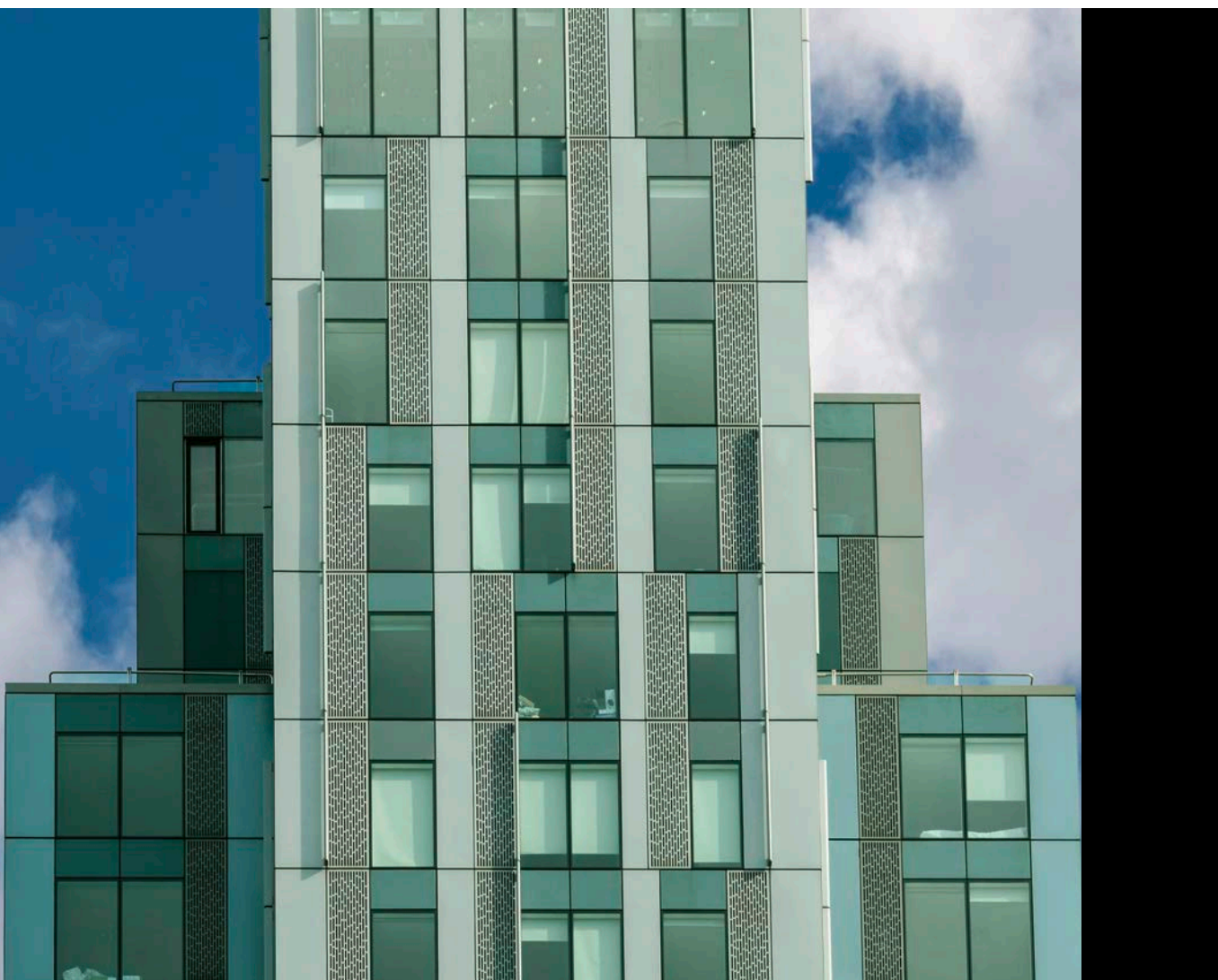

A façade support system for
hook-on cladding panels





Contents

Simple. Safe. Quality assured.	1
Why choose HookFix?	3
In detail	5
Component list	7
Technical information	8
The SPIDI advantage brought to you by Fixfast	9

Simple. Safe. Quality assured.

The first choice for hook-on metal rainscreen panels and cassettes.

Ideal for cladding elements such as:

- + Metal panels, planks, or profiles
- + Timber panels or planks

Proven performance. Patented product.

The innovative SPIDI Max helping hand bracket (available in aluminium or stainless steel) is configured with vertical support rails to support your hook-on rainscreen cladding.

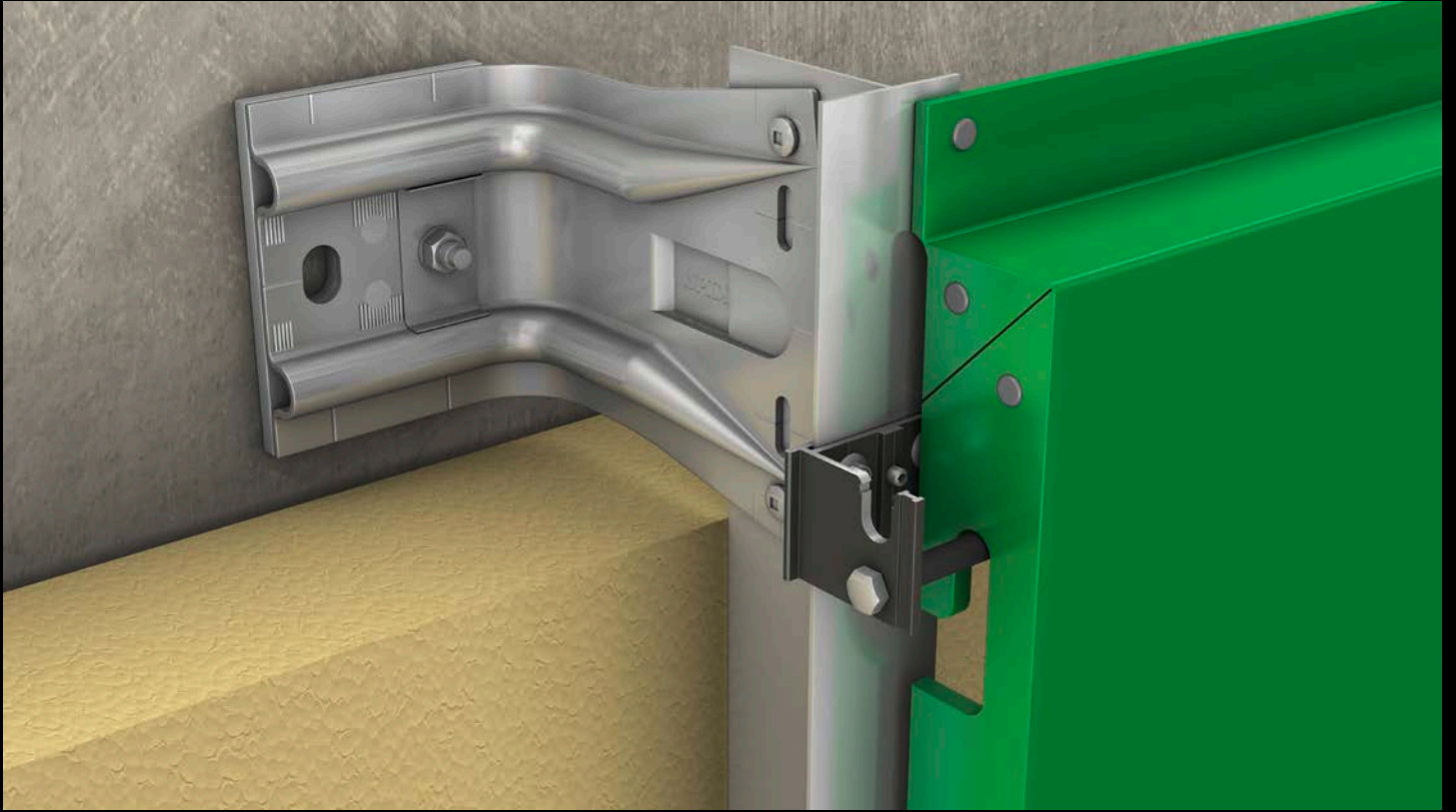

Why choose HookFix?

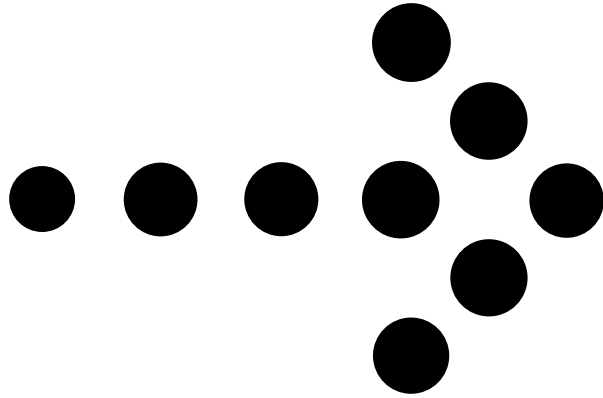

- + It's a fully engineered system for hook-on cladding fabricated with suitable slots/hooks or pins/bolts
- + Realise your architectural intent, cladding design, engineering and installation requirements through adjustable hook-brackets and multiple rail designs, sizes, orientations, and finishes
- + Cater for the widest range of rainscreen cavities with SPIDI Max helping hand brackets - from 60mm up to 600mm
- + Simplify your design, procurement, and installation by using the same innovative SPIDI Max helping hand bracket for both dead load (fixed point), and lateral restraint (sliding point) applications
- + Meet thermal performance requirements using SPIDI Max aluminium helping hand brackets complete with thermal isolator pads, or Passive House Institute certified A2 or A4 stainless steel brackets
- + Back up your quality soffit support solution with Fixfast SHOQS (Simple, Honest, On-Time, Quality Service) at all stages of your project

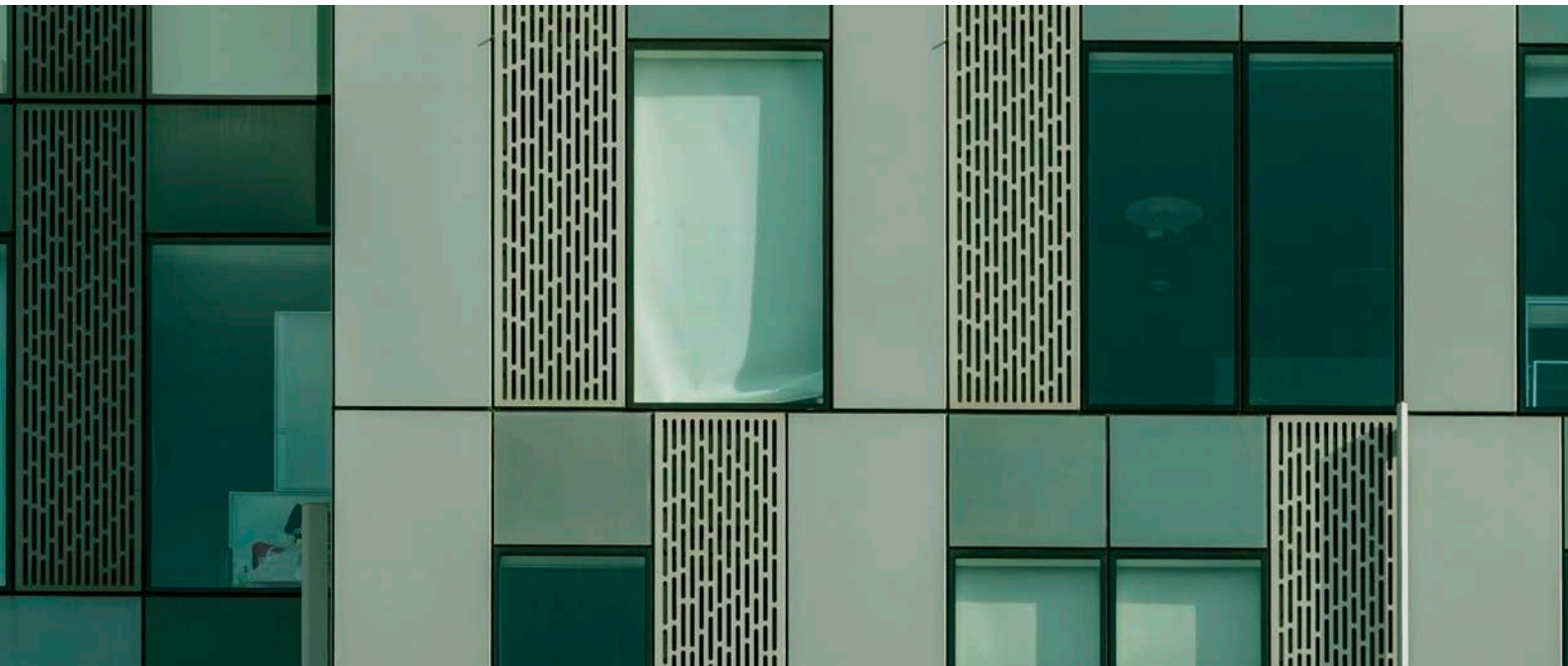

In detail

Where can I use HookFix?

- + New build
- + Refurbishments
- + External cladding
- + Internal cladding

What type of cladding does HookFix suit?

- + Aluminium and other metal cassette panels
- + Expanded mesh panels

How is HookFix attached?

- + The HookFix system can be supplied with suitable slots/hooks or pins/bolts to attach to the adjustable aluminium cladding

What support profile options are available?

- + Vertical cladding support profiles
- + Single layer or two-layer systems
- + L, T, Y, and U-shaped extrusions
- + Mill finish

What are the options for SPIDI Max helping hand brackets?

- + Same bracket for deadload (fixed) and lateral restraint (sliding) applications
- + Aluminium, A2 or A4 stainless steel
- + Pre-fitted but removable thermal isolator pad
- + Suits rainscreen cavity widths from 40mm to 600mm

What substrates does HookFix work with?

- + SFS (Steel Framing System)
- + Steel
- + Aluminium
- + Concrete
- + Masonry
- + Timber



**Flexible for either vertical
or horizontal applications**

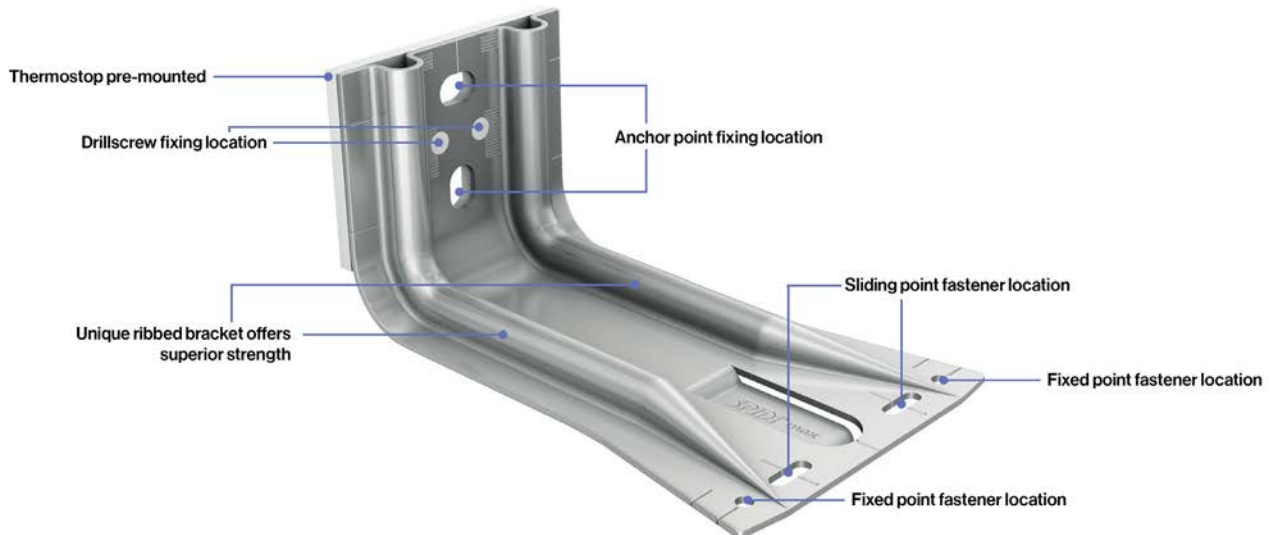

Component list

CATEGORY	PRODUCT DESCRIPTION	PRODUCT CODE
Cladding fixings	Contact Fixfast	-
Cladding attachment	Cassette mounting adaptor with 10mm stainless steel bolt (black anodised)	SP-CMA-10-BLACK
Cladding attachment	Cassette mounting adaptor (black anodised)	SP-CMA-BLACK
Cladding attachment fixing	DrillFast® 4.8 x 25 A2/304 stainless mainfix fastener no washer	DF3-SS-4.8 x 25
Support rail	SPIDI® flat L-rail (mill finish) 3m	SP-PL-A-40/60/2.0/3
Support rail	SPIDI® cassette mounting U-rail (mill finish) 3m	SP-PU-A-107/28/1.8/3
Support rail	SPIDI® cassette mounting Y-rail (mill finish) 3m	SP-PY-A-107/98/1.8/3
Support rail	SPIDI® flat T-rail (mill finish) 3m	SP-PT-A-120/60/2.0/3
Support rail	SPIDI® flat T-rail (black anodised) 3m	SP-PT-A-120/60/2.0/3-BLACK
Support rail fixing	DrillFast® 4.8 x 25 A2/304 stainless mainfix fastener no washer	DF3-SS-4.8 x 25
Helping hand bracket	SPIDI® Max aluminium bracket and 6mm isolator (40-900mm)	SP-MAX-A-80/(40-900)
Helping hand bracket	SPIDI® Max A2/304 stainless bracket and 6mm isolator (40-900mm)	SP-MAX-SSA2-80/(40-900)
Helping hand bracket	SPIDI® Max A4/316 stainless bracket and 6mm isolator (40-900mm)	SP-MAX-SSA4-80(40-900)
Helping hand bracket fixing – Steel substrate	DrillFast® 6.0 x 45 A2/304 stainless halter fastener no washer	DF2-SS-6.0 x 45
Helping Hand Bracket	Fixing Timber Substrate - DrillFast® Stainless Mainfix Timber Fastener, 19mm Washer	DFT-SS-A19-6.0 x 75
Helping Hand Bracket	Fixing Concrete Substrate - CELO 10mm Multifunctional Frame Plug with Stainless Hex Screw	MFRFB-10 x 80 SSKS A4
Helping Hand Bracket	Fixing Masonry Substrate - CELO 10mm Multifunctional Frame Plug with Stainless Hex Screw	MFRFB-10 x 80 SSKS A4

Technical information

MATERIAL	Aluminium, stainless steel
FINISH	Mill finish, anodised, PPC (Polyester Powder Coat)
COLOUR	Silver, black, other
WARRANTY	Up to 40 years
COMPONENT	Aluminium rails
STANDARD & GRADE	BS EN 573-3:2009 EN AW-6063 T66
COMPONENT	Aluminium brackets
STANDARD & GRADE	BS EN 573-3:2009 EN AW-5052 H12
COMPONENT	A2/304 stainless steel brackets
STANDARD & GRADE	BS EN 10088-2:2005 X5CrNi18-10 (1.4301/304)
COMPONENT	A4/316 stainless steel brackets
STANDARD & GRADE	BS EN 10088-2:2005 X2CrNiMo17-12-2 (1.4404/316L)

3rd Party Certification

- + ETA (European Technical Assessment) ETA-17/0461
- + Passive House Component ID: 2361fa03



The SPIDI advantage brought to you by Fixfast

For 40+ years the patented SPIDI® façade system has been trusted by building developers, architects, engineers, contractors and cladding manufacturers for the quick and safe installation of rainscreens and soffits.

Maximum reliability

Structural

High-strength SPIDI Max helping hand brackets feature end-to-end stiffening ribs for increased torsional rigidity. Manufactured from aluminium or stainless steel, the brackets are available up to 600mm long, with soffit brackets over 900mm long.

Thermal

The SPIDI Max helping hand bracket design uses less material to reduce thermal point losses and enhance the weighted U-value.

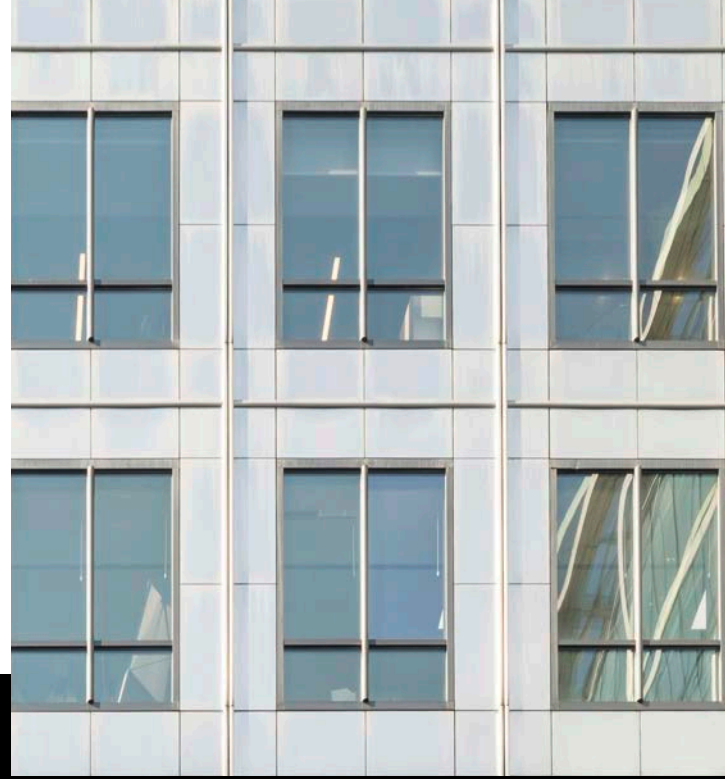

Environmental

An optimised structural design enables more efficient use of recyclable material, minimising embodied carbon.

Minimum fuss

Specification

Simple support solutions designed to work with all common cladding types, configured to meet your exact architectural and structural performance requirements.

Pricing

Project costing made easy, whatever stage your project is. From a quick budget price to a full quotation, let us provide what you need – including a detailed component schedule and parts cost.

Design and Engineering

Project-specific, Eurocode compliant structural calculations, accurate Chi data and weighted U-value assessments ensure you have certainty in the performance of Fixfast façade support systems.

Uncomplicated systems with minimal component types to speed up drawing, modelling and scheduling.

Procurement

A single helping hand bracket for deadload (fixed) and restraint (sliding) locations, horizontal and vertical façade systems, and soffit systems.

Simple procurement means less material wastage, reducing both administration and cost.

Installation

With a 'one bracket' design, on-site material management is simplified.

All SPIDI Max helping hand brackets incorporate an integrated thermal isolator pad, plus a spring clip to speed up support rail installation and alignment before final fix.

Quality Assurance

Product quality is supported by a European Technical Assessment (ETA) and EN 1090-1 Declaration of Performance (DoP).

And the advantage of fewer component variations reduces the risk of installation errors.

Our Fixfast level of support means your team have the assistance they need, when they need it – every time.

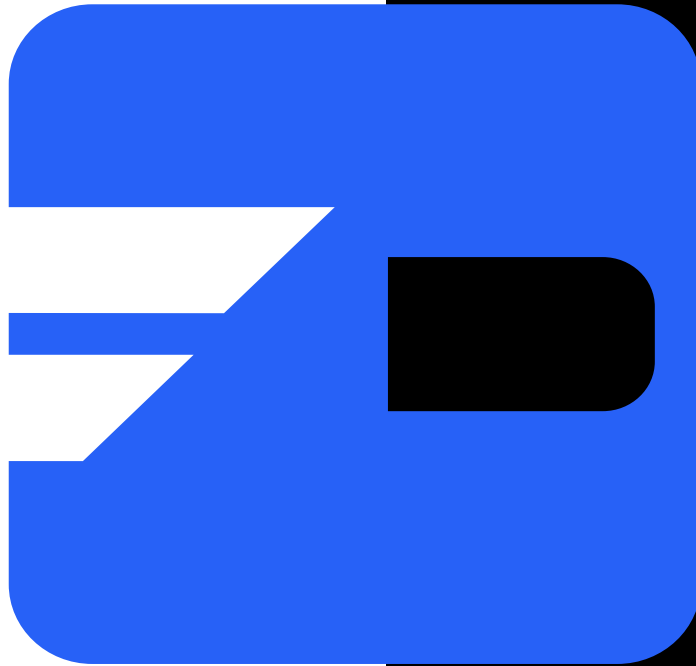

Fixfast Helping Hand

Simplify the estimating process by trying our new Helping Hand Project Estimator Tool today. Available 24/7 - online or download for iOS or Android.

Maximum reliability. Minimum fuss.

“

The SPIDI Max façade brackets as part of the system adopted was a complete package solution. Fixfast provided a quality product coupled with professional and friendly support.

”

- Façade Contractor

[Learn more about
HookFix](#)



Contact Details:

Fixfast Ltd
Unit 6
Frank Sando Way
Aylesford
Kent
ME20 7NY

T: +44 (0) 1732 882 387
E: sales@fixfast.com
W: fixfast.com

