

SPIDI® MechFix

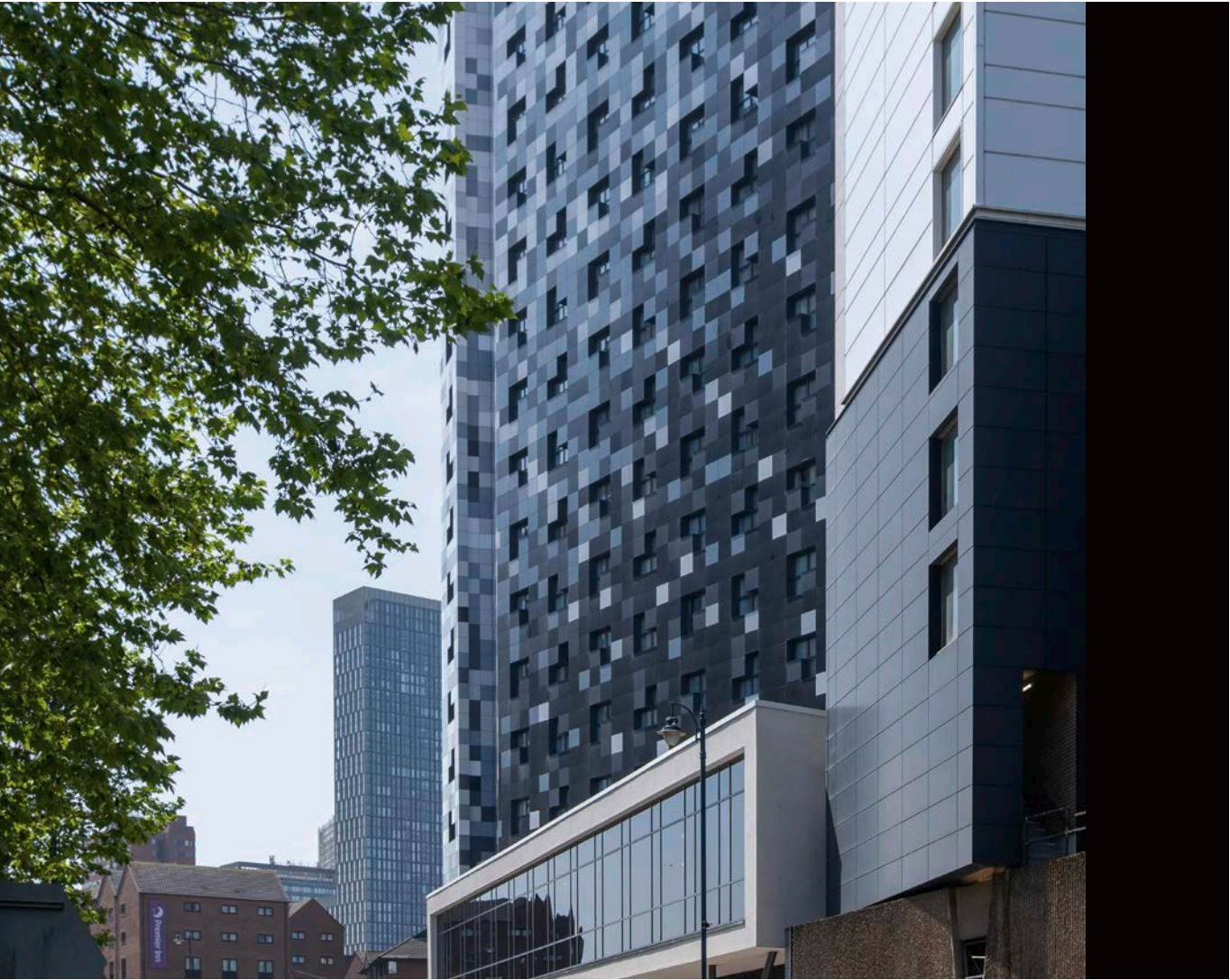

**A façade support system for
mechanically fixed cladding panels**





Contents

| | |
|---|----------|
| Simple. Safe. Quality assured. | 1 |
| Why choose MechFix? | 3 |
| In detail | 5 |
| Component list | 7 |
| Technical information | 8 |
| The SPIDI advantage brought to you by Fixfast | 9 |

Simple. Safe. Quality Assured.

The first choice for screw and rivet fixed cladding elements within your rainscreen project.

Ideal for cladding elements such as:

- + Metal panels
- + Fibre cement panels
- + Mineral fibre panels

Proven performance. Patented product.

The innovative SPIDI Max helping hand bracket (available in aluminium or stainless steel) can be configured with horizontal or vertical support rails to suit your mechanically fixed rainscreen cladding project.

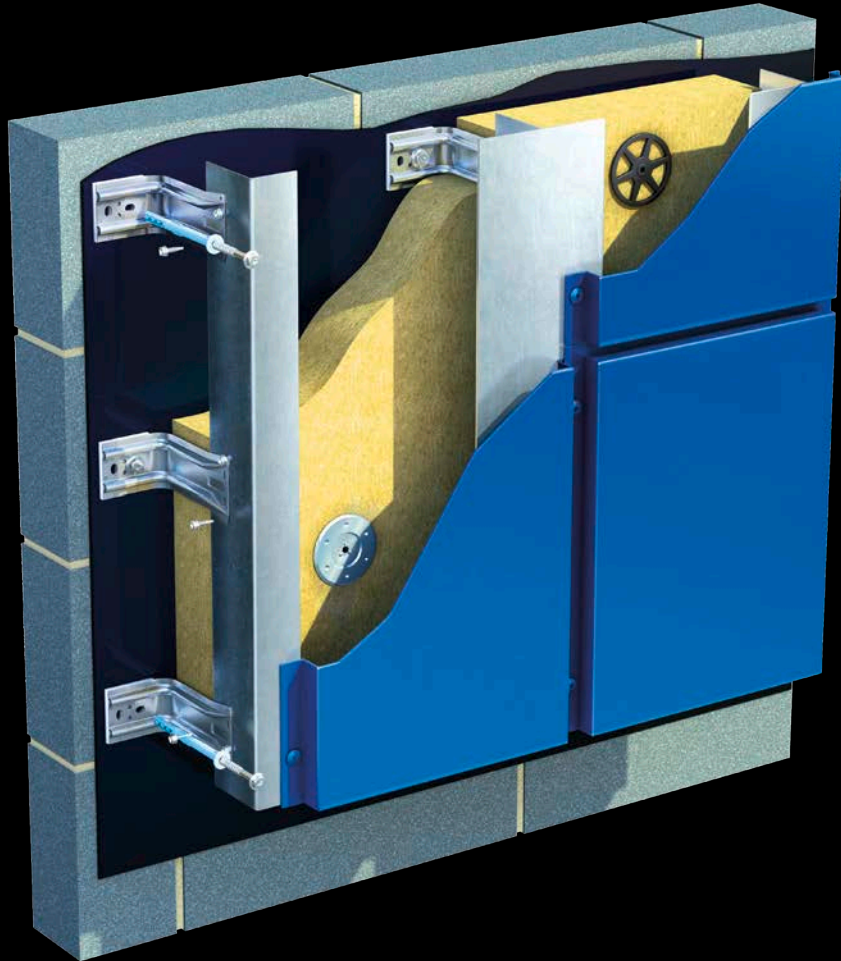

Why choose MechFix?

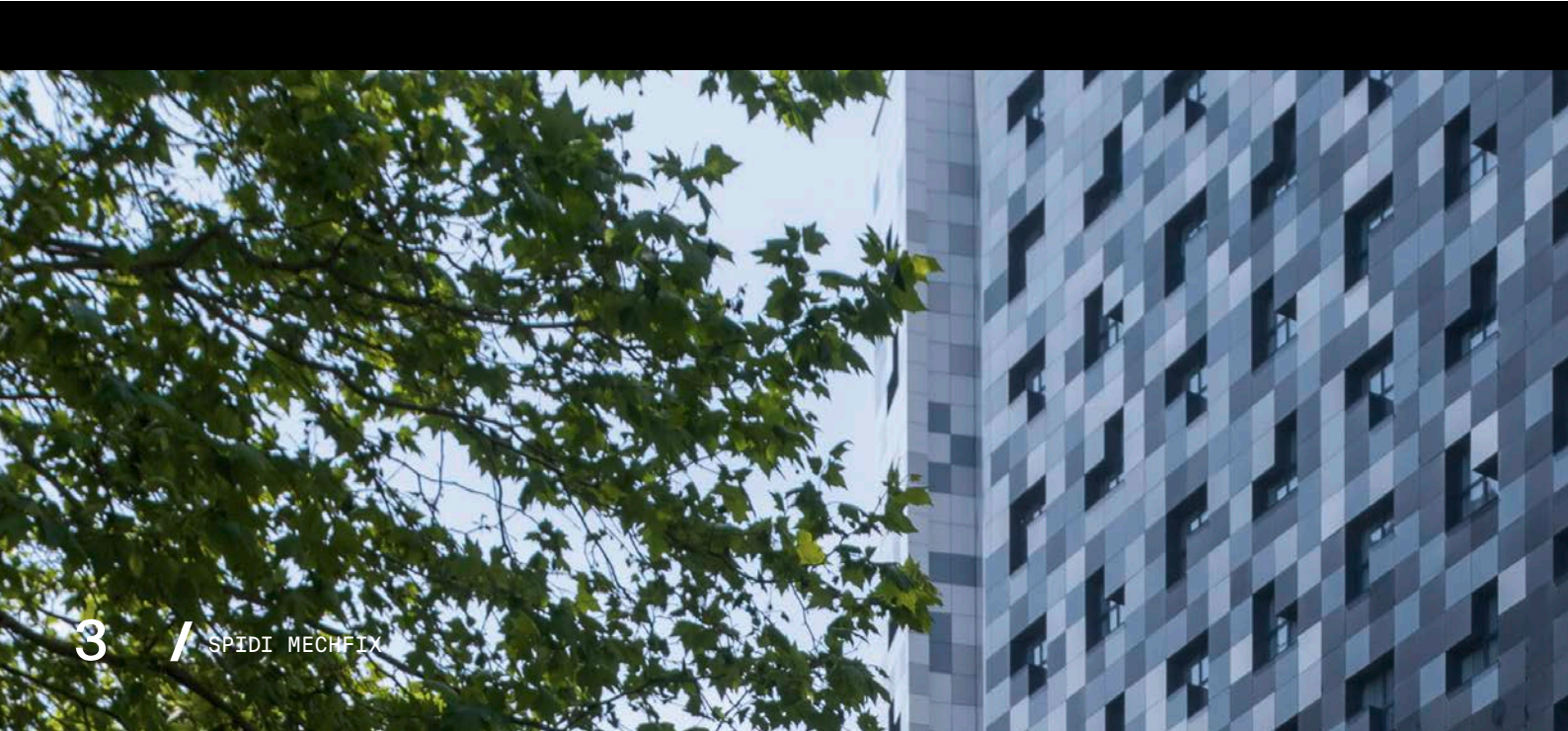
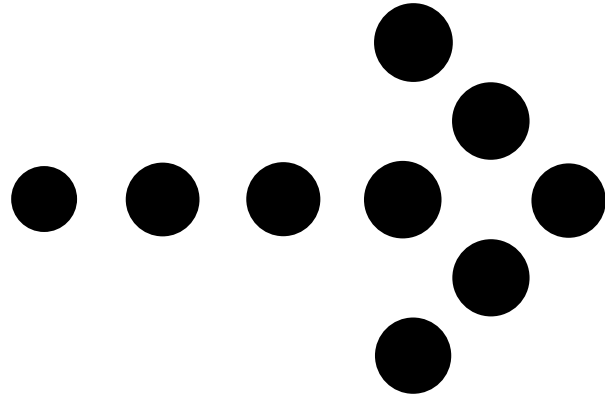

- + It's a fully engineered system for any cladding type attached to vertical or horizontal support rails with screws or rivets
- + Realise your architectural intent, cladding design, engineering and installation requirements through multiple rail designs, sizes, orientations and finishes
- + Cater for the widest range of rainscreen cavities with SPIDI Max helping hand brackets – from 60mm up to 600mm
- + Simplify your design, procurement, and installation by using the same innovative SPIDI Max helping hand bracket for both dead load (fixed point), and lateral restraint (sliding point) applications
- + Meet thermal performance requirements using SPIDI Max aluminium helping hand brackets complete with thermal isolator pads, or Passive House Institute certified A2 or A4 stainless steel brackets
- + Back up your quality façade support solution with Fixfast SHOQS (Simple, Honest, On-time, Quality Service) at all stages of your project

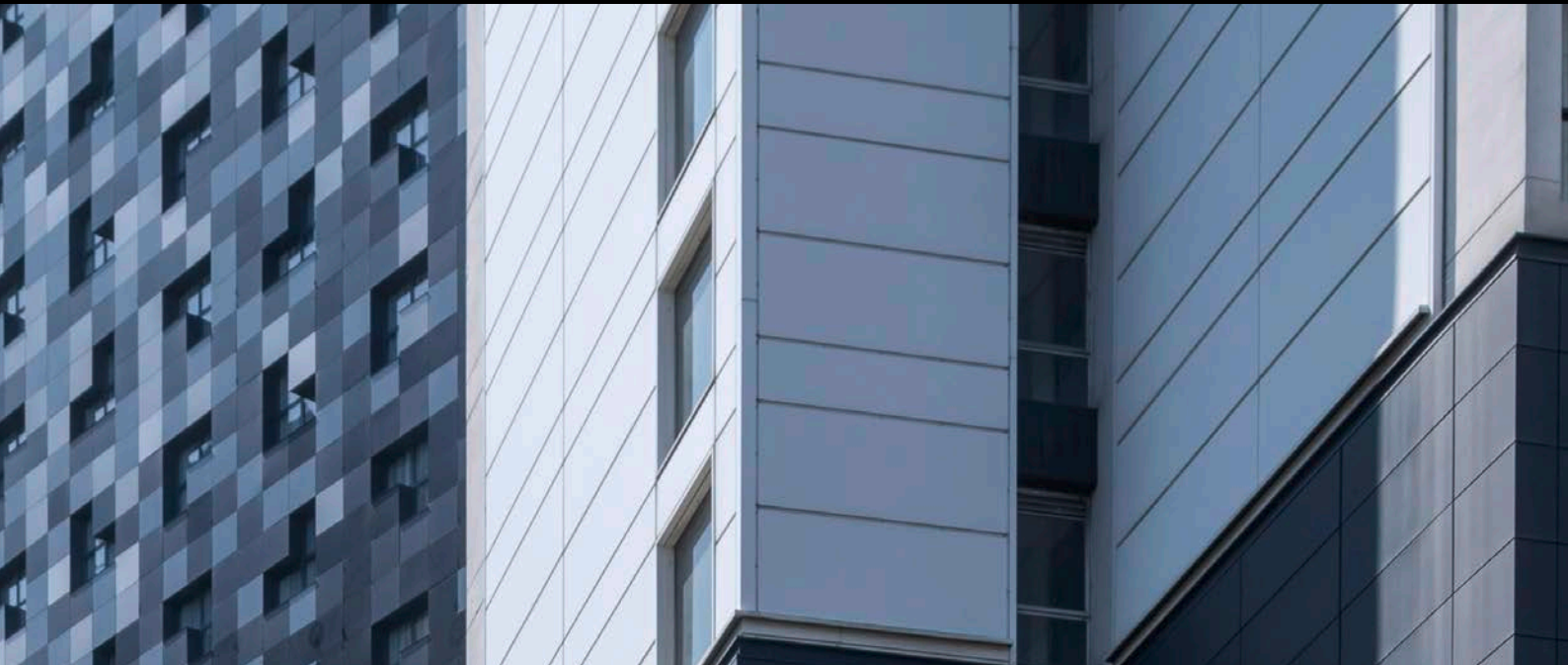

In detail

Where can I use MechFix?

- + New build
- + Refurbishments
- + External cladding
- + Internal cladding

What type of cladding does MechFix suit?

- + Aluminium and other metal panels
- + Fibre cement
- + Mineral fibre
- + GRC (Glass Reinforced Concrete)
- + HPL (High Pressure Laminate)
- + Timber and weatherboarding
- + Porcelain, ceramic, and stone

What support profile options are available?

- + Vertical and horizontal cladding support profiles
- + Single layer or two-layer systems
- + L, T, Q, and Z shaped extrusions
- + Mill finish, black anodised, or powder-coated

What are the options for SPIDI Max helping hand brackets?

- + Same bracket for deadload (fixed) and lateral restraint (sliding) applications
- + Aluminium, A2 or A4 stainless steel
- + Pre-fitted but removable thermal isolator pad
- + Suits rainscreen cavity widths from 60mm to 600mm

What substrates does MechFix work with?

- + SFS (Steel Framing System)
- + Steel
- + Aluminium
- + Concrete
- + Masonry
- + Timber



**Flexible for either vertical
or horizontal applications**

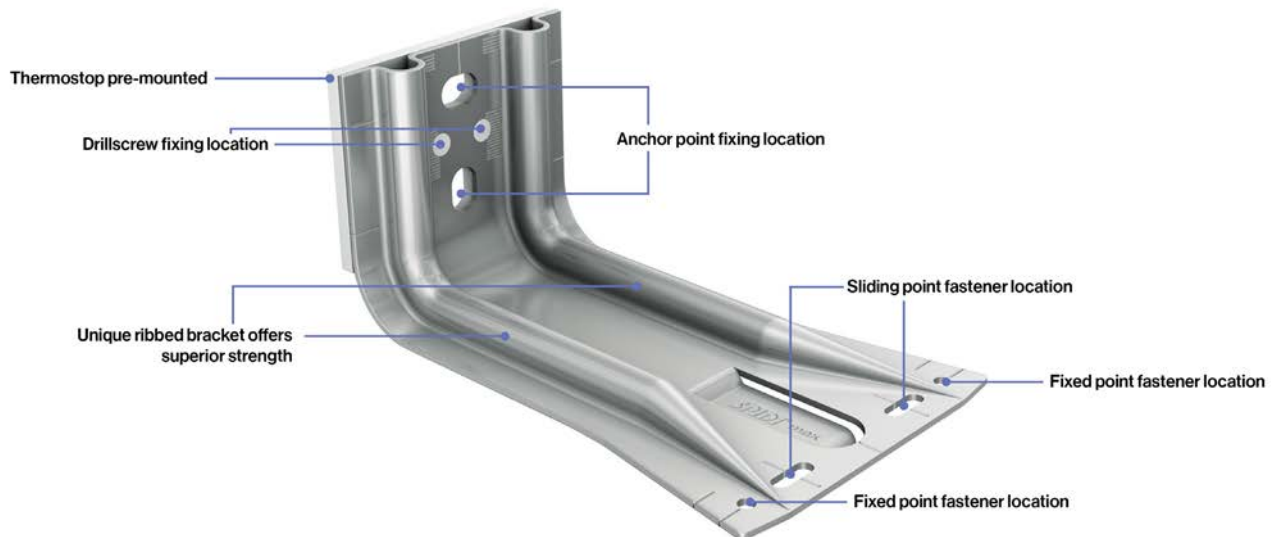

Component list

| CATEGORY | PRODUCT DESCRIPTION | PRODUCT CODE |
|---|---|----------------------------|
| Cladding fixings Cladding attachment Cladding attachment fixing | Contact Fixfast | - |
| Support rail | SPIDI® flat L-rail (mill finish) 3m | SP-PL-A-40/60/2.0/3 |
| Support rail | SPIDI® flat L-rail (black anodised) 3m | SP-PL-A-40/60/2.0/3-BLACK |
| Support rail | SPIDI® 32mm Q-rail (mill finish) 3m | SP-PO-32/1.8/3 |
| Support rail | SPIDI® flat T-rail (mill finish) 3m | SP-PT-A-120/60/2.0/3 |
| Support rail | SPIDI® flat T-rail (black anodised) 3m | SP-PT-A-120/60/2.0/3-BLACK |
| Support rail fixing | DrillFast® 4.8 x 25 A2/304 stainless mainfix fastener no washer | DF3-SS-4.8 x 25 |
| Helping hand bracket | SPIDI® Max aluminium bracket and 6mm isolator (40-900mm) | SP-MAX-A-80/(40-900) |
| Helping hand bracket | SPIDI® Max A2/304 stainless bracket and 6mm isolator (40-900mm) | SP-MAX-SSA2-80/(40-900) |
| Helping hand bracket | SPIDI® Max A4/316 stainless bracket and 6mm isolator (40-900mm) | SP-MAX-SSA4-80/(40-900) |
| Helping hand bracket fixing – Steel substrate | DrillFast® 6.0 x 45 A2/304 stainless halter fastener no washer | DF2-SS-6.0 x 45 |
| Helping hand bracket fixing – Aluminium substrate | DrillFast® 6.0 x 45 A2/304 stainless halter fastener no washer | DF2-SS-6.0 x 45 |
| Helping hand bracket fixing – Timber substrate | DrillFast® 6.0 x 75 A2/304 stainless mainfix timber fastener, 19mm washer | DFT-SS-A19-6.0 x 75 |
| Helping hand bracket fixing – Concrete substrate | CELO 10mm multifunctional frame plug with stainless hex screw | MFRFB-10 x 80 SSKS A4 |
| Helping hand bracket fixing – Masonry substrate | CELO 10mm multifunctional frame plug with stainless hex screw | MFRFB-10 x 80 SSKS A4 |

Technical information

| | |
|-----------------------------|---|
| MATERIAL | Aluminium, stainless steel |
| FINISH | Mill finish, anodised, PPC (Polyester Powder Coat) |
| COLOUR | Silver, black, other |
| WARRANTY | Up to 40 years |
| COMPONENT | Aluminium rails |
| STANDARD & GRADE | BS EN 573-3:2009 EN AW-6063 T66 |
| COMPONENT | Aluminium brackets |
| STANDARD & GRADE | BS EN 573-3:2009 EN AW-5052 H12 |
| COMPONENT | A2/304 stainless steel brackets |
| STANDARD & GRADE | BS EN 10088-2:2005 X5CrNi18-10 (1.4301/304) |
| COMPONENT | A4/316 stainless steel brackets |
| STANDARD & GRADE | BS EN 10088-2:2005 X2CrNiMo17-12-2 (1.4404/316L) |

3rd Party Certification

- + **ETA (European Technical Assessment) ETA-17/0461**
- + **Passive House Component ID: 2361fa03**



The SPIDI advantage brought to you by Fixfast

For 40+ years the patented SPIDI® façade system has been trusted by building developers, architects, engineers, contractors and cladding manufacturers for the quick and safe installation of rainscreens and soffits.

Maximum reliability

Structural

High-strength SPIDI Max helping hand brackets feature end-to-end stiffening ribs for increased torsional rigidity. Manufactured from aluminium or stainless steel, the brackets are available up to 600mm long, with soffit brackets over 900mm long.

Thermal

The SPIDI Max helping hand bracket design uses less material to reduce thermal point losses and enhance the weighted U-value.



Environmental

An optimised structural design enables more efficient use of recyclable material, minimising embodied carbon.

Minimum fuss

Specification

Simple support solutions designed to work with all common cladding types, configured to meet your exact architectural and structural performance requirements.

Pricing

Project costing made easy, whatever stage your project is. From a quick budget price to a full quotation, let us provide what you need – including a detailed component schedule and parts cost.

Design and Engineering

Project-specific, Eurocode compliant structural calculations, accurate Chi data and weighted U-value assessments ensure you have certainty in the performance of Fixfast façade support systems.

Uncomplicated systems with minimal component types to speed up drawing, modelling and scheduling.

Procurement

A single helping hand bracket for deadload (fixed) and restraint (sliding) locations, horizontal and vertical façade systems, and soffit systems.

Simple procurement means less material wastage, reducing both administration and cost.

Installation

With a 'one bracket' design, on-site material management is simplified.

All SPIDI Max helping hand brackets incorporate an integrated thermal isolator pad, plus a spring clip to speed up support rail installation and alignment before final fix.

Quality Assurance

Product quality is supported by a European Technical Assessment (ETA) and EN 1090-1 Declaration of Performance (DoP).

And the advantage of fewer component variations reduces the risk of installation errors.

Our Fixfast level of support means your team have the assistance they need, when they need it – every time.

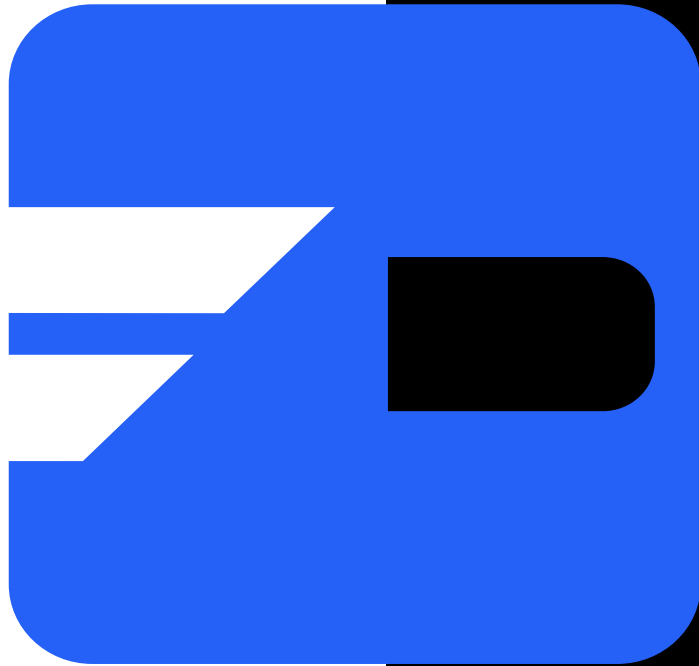

Fixfast Helping Hand

Simplify the estimating process by trying our new Helping Hand Project Estimator Tool today. Available 24/7 - online or download for iOS or Android.

Maximum reliability. Minimum fuss.

“

We were fortunate in being able to use the same SPIDI Max bracket for both façade and soffit support... greatly helped simplify our process from design through to install.

”

- Façade Contractor, Scotland

[Learn more about MechFix](#)



Contact Details:

Fixfast Ltd
Unit 6
Frank Sando Way
Aylesford
Kent
ME20 7NY

T: +44 (0) 1732 882 387
E: sales@fixfast.com
W: fixfast.com

