

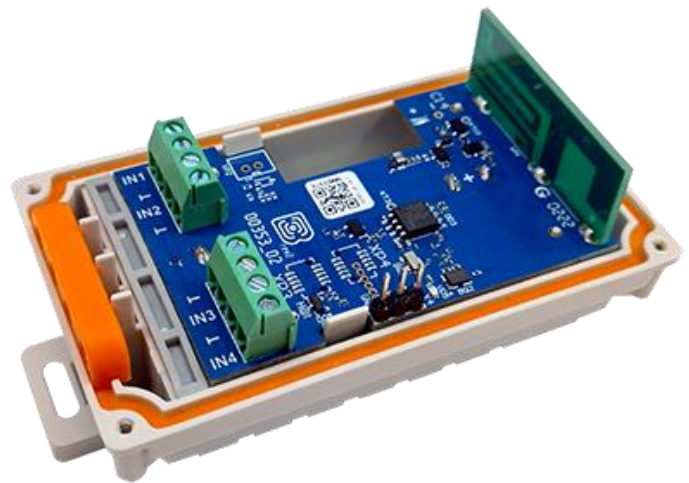

# PULSE COUNTER VEGA SI-11 REV.2

## USER MANUAL



DOCUMENT REVISION	FIRMWARE VERSION
30	3.0

# CONTENTS

INTRODUCTION.....	3
1 DEVICE PURPOSE AND OPERATION PRINCIPAL.....	4
Device purpose.....	4
Operation algorithm.....	4
Functional.....	6
Marking.....	6
2 SPECIFICATION.....	7
Device Specification.....	7
Default Device Settings.....	8
3 OPERATION.....	9
Device Appearance.....	9
Contacts Description.....	10
LED Indications.....	11
Hall sensor.....	12
FSK radio channel.....	13
Connecting meter to a personal computer.....	13
Connecting meter to a personal computer via Vega USB-UART connector.....	14
Mounting Recomendations.....	16
4 COMMUNICATION PROTOCOL – version 2.0.....	18
Vega SI-11 rev.2 pulse counter transmits the following types of packets.....	18
1. Packet with current readings.....	18
2. Settings packet.....	19
Vega SI-11 rev.2 pulse counter receives packets of the following types.....	20
1. Packet with request of settings.....	20
2. Packet with settings.....	20
5 STORAGE AND TRANSPORTATION REQUIREMENTS.....	22
6 CONTENT OF THE PACKAGE.....	23
7 WARRANTY.....	24

## INTRODUCTION

This manual is designated for Vega SI-11 rev.2 pulse counter (hereinafter – the counter) manufactured by Vega-Absolute OOO and provides information on powering and activation procedure, control commands and functions of the counter.

This manual is targeted at specialists familiar with installation work fundamentals of electronic and electrical equipment.

Vega-Absolute OOO reserves the right to make changes to the manual related to the improvement of equipment and software, as well as to eliminate typos and inaccuracies, without prior notice.

# 1 DEVICE PURPOSE AND OPERATION PRINCIPAL

## DEVICE PURPOSE

Vega SI-11 rev.2 pulse counter is designed for counting of pulses incoming to 4 independent inputs, further accumulating and transmitting of this information to the LoRaWAN® network.

In addition, Vega SI-11 rev.2 can be used as a security device - anyone of four inputs can be configured as security input.

The pulse counter can be used for any utilities' meters and industrial equipment with pulse output of herkon type or open-drain type.



Equipment with NAMUR pulse output is not supported

The counter is powered by a 3.6 V battery type A.



**The device is powered by a non-rechargeable lithium-thionyl chloride (LiSOCl<sub>2</sub>) battery  
Attempts to charge the battery may result in fire**



Long-term storage of equipment outside the operating mode leads to battery passivation, which does not allow the equipment to operate in the declared mode.  
For correct operation, before starting the equipment, carry out the depassivation process. To request the instructions please e-mail us [support@vega-absolute.ru](mailto:support@vega-absolute.ru)

## OPERATION ALGORITHM

Vega SI-11 rev.2 operates in modes listed below:

**"Storage"** – is a mode for storing and transporting. In this mode the device does not communicate regularly with the network.

**"Active"** – is a main mode of device operation.

Initially, the device is not connected to power, because a plastic plug is installed between the battery contact and the device contact, which must be removed before putting the sensor into operation.

Vega SI-11 rev.2 supports two activation methods in the LoRaWAN® network - ABP and OTAA. Select one of the methods via the "Vega LoRaWAN Configurator" application (see "User Manual" on the program).

**ABP method.** After pressing the start button, the device immediately starts working in the "Active" mode.

**OTAA method.** After pressing the start button, the device makes three attempts to connect to the network within the set frequency plan. After the activation in the LoRaWAN® network is confirmed, the device sends a signal (LED flashing for 5 seconds) and switches to the "Active" mode. If all attempts fail, the counter will continue to accumulate data and will attempt to connect to the network every 6 hours.

To switch the device from the "Active" mode back to the "Storage" mode possible by the prolonged exposure (longer than 10 seconds) of the magnetic field (magnet proximity) on the Hall sensor.



**When switching to the "Storage" mode, all readings from the pulse inputs accumulated in the device memory are reset**

The device forms the data packet with current state with a configurable period from 5 minutes to 24 hours. The packets stored in the device memory and transmitting during the next communication session with the LoRaWAN® network.

### *Examples*

If the data collection period is set to 24 hours the packet is formed at 00.00 on the internal clock of the device

If the data collection period is 12 hours then at 00.00 and at 12.00, and so on.

The adjustable data transfer period can be from 5 minutes to 24 hours. When beginning of communication session, the device starts sending packets with readings from the earliest packet. The time of data transmitting cannot be specified, it's defined in random way for every device in chosen period of transmission from the moment of connection to the network.

### *Example*

Transmission period is 30 minutes, and device was started at 16:40 by the internal device clock. In random way the device calculate data transmitting time and set it at 16:41 in the half-hour period from 16:40 to 17:10. Thus, packets from this device will transmit at 16:41, at 17:11, at 17:41, at 18:11 and so on every 30 minutes by the internal device clock.

The internal clock is set automatically when you connect to the device via service UART connector, also can be adjust via LoRaWAN® network.

## FUNCTIONAL

Vega SI-11 rev.2 pulse counter is A class device (LoRaWAN® classification) and has the following features:

- ⦿ ADR support (Adaptive Data Rate)
- ⦿ Sending of confirmed packets
- ⦿ Two operating modes: "Active" and "Storage"
- ⦿ Inputs can be switched to "security" mode for connection to external leakage and safety sensors, etc.
- ⦿ Queue for sending packets if delivery fails
- ⦿ Time referencing of readings by internal clock
- ⦿ Communication in case of security inputs actuation
- ⦿ Temperature measurement
- ⦿ Charge measuring of the built-in battery (%)

## MARKING

Device marked with **sticker** that contains the following information:

- ⦿ Device name;
- ⦿ DevEUI;
- ⦿ Release Date;
- ⦿ Certification marks.

**Sticker located in three places** – on device case, in factory certificate and on the packing box.

Besides, there is an **additional sticker** located on the packing box which contains:

- ⦿ Information about firmware version;
- ⦿ QR code containing device activation keys in the LoRaWAN® network, production date and other identifiers.

## 2 SPECIFICATION

### DEVICE SPECIFICATION

MAIN	
Double-contact digital inputs	up to 4
Maximum input frequency	200 Hz
Security inputs	up to 4
PC interface	UART, FSK radio channel
Operating temperatures	-40...+85 °C
LORAWAN®	
LoRaWAN® class	A
Quantity of LoRa channels	16
Frequency plans supported by default	RU868, EU868, KZ865, custom (EU868 based)
Frequency plans available as order option	IN865, AS923, AU915, KR920, US915
Activation type	ABP or OTAA
Communication period	5, 15, 30 minutes, 1, 6, 12 or 24 hours
Data collection period	5, 15, 30 minutes, 1, 6, 12 or 24 hours
Memory amount for storing packets	200 packets
Type of the LoRaWAN antenna	internal
Sensitivity	-138 dBm
Radio coverage in restrained urban conditions	up to 5 km
Radio coverage within line of sight	up to 15 km
Transmitter power by default	25 mW (configurable)
POWER	
Battery	LiSOCl <sub>2</sub> 3.6 V, type A
Calculated number of packets sent by the device with default settings	80 000
CASE	
Device dimensions, no more than	90 x 49 x 46 mm
Ingress protection rating	IP65
Mounting	Clamp fastening to the support, DIN-rail, wall-mounting
PACKAGE	
Dimensions	95 x 50 x 46 mm
Weight	0.093 kg

**DEFAULT DEVICE SETTINGS**

PARAMETER	VALUE
Frequency plan	RU868
Activation type	OTAA
Adaptive Data Rate	ON
Confirmed Uplinks	OFF
Rx 1 Delay	1 second
Join Accept Delay	5 seconds
Uplink number of transmissions	1
Data rate	DR0
Power	14 dBm
Communication period	24 hours
Data collection period	24 hours
Time zone	UTC +00:00
Inputs operate in mode	pulse

For changing the device settings, you need to connect to it with “Vega LoRaWAN Configurator” application. You can download app on the [iotvega.com](https://www.vega.com) site in SOFT section as well as User Manual for configurator. [Go to the app page.](#)



## 3 OPERATION

### DEVICE APPEARANCE

Vega SI-11 rev.2 is represented in small plastic case which has four screws and mounting for DIN-rail.

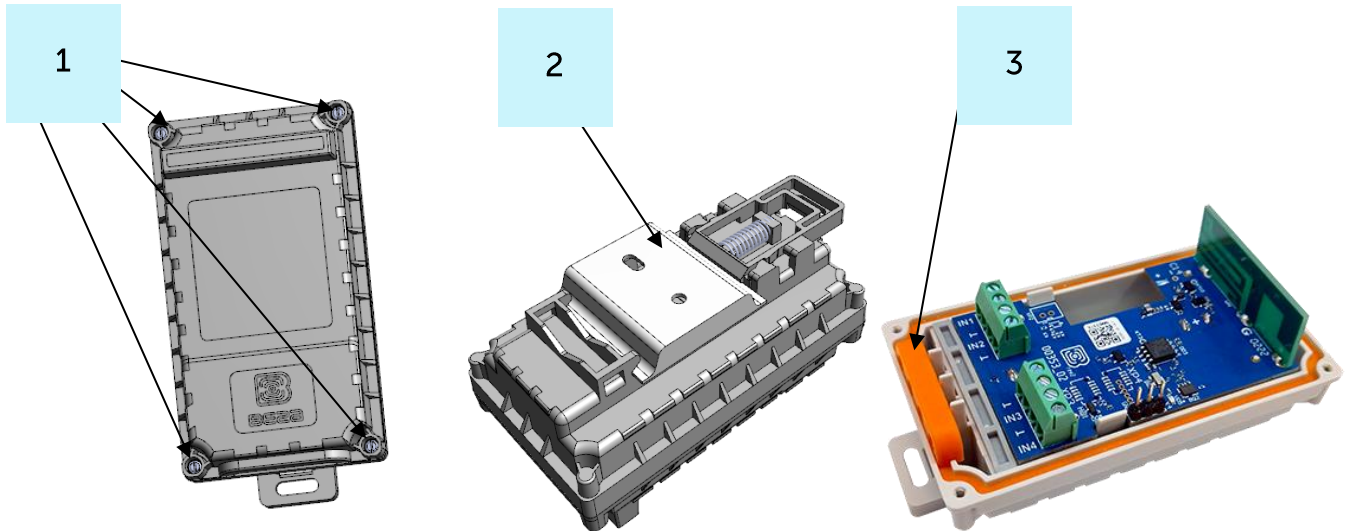

1 – screw  $\varnothing$  2 mm x 8 mm, cross 

2 – DIN-rail with mounting holes  $\varnothing$  3 mm

3 – silicone gasket without through holes, ensuring the protection rating of the device case IP65.

All of elements for manage and indication as well as connecting contacts are placed on the board inside the case.

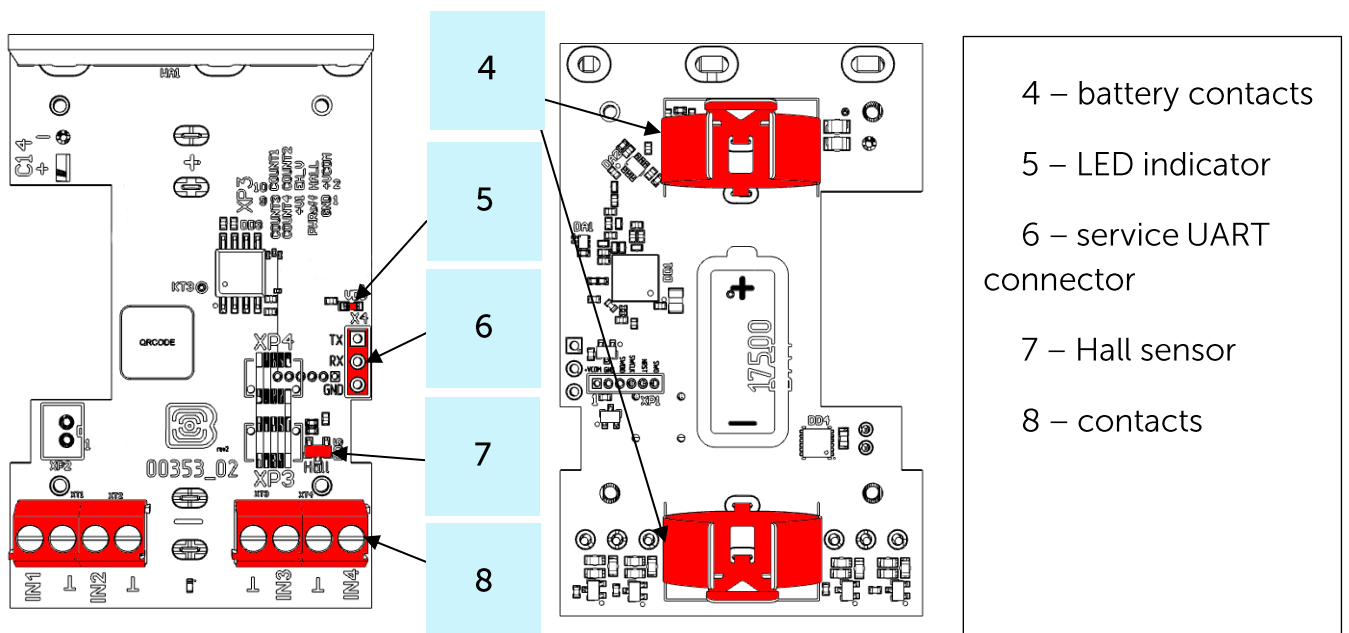

## CONTACTS DESCRIPTION

When connecting a radio modem to external devices, consider the **internal circuitry** of its pulse inputs shown below.

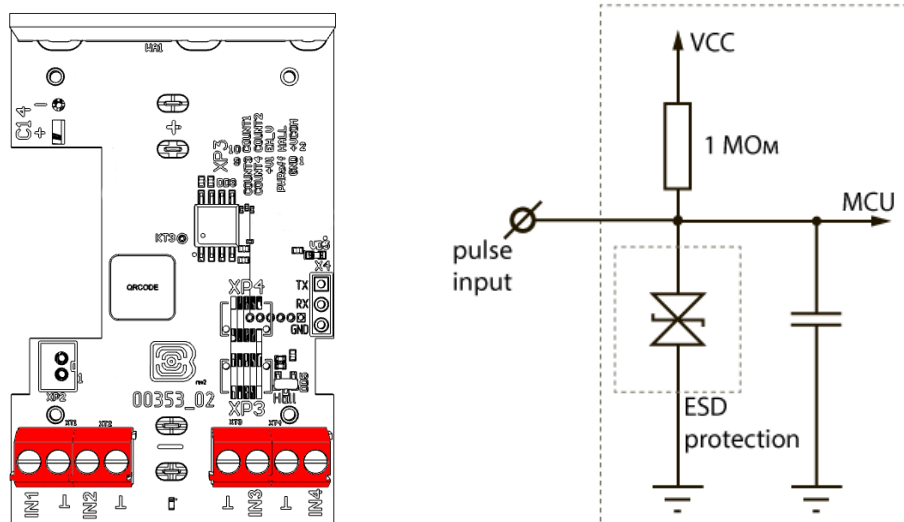

**De-bouncing logics** with 5 msec time constant is integrated in the pulse counter. The pulse counting is carried out for frequencies up to 200 Hz.

The pulse counter has 4 pairs of contacts that allows to connect circuits with the following **types of NO contacts**:

- ⦿ reed switch;
- ⦿ mechanical pushbutton;
- ⦿ open-collector output.



**Equipment with NAMUR pulse output is not supported**

Polarity effects only "open collector" circuits.

To reset all readings from the **pulse inputs** accumulated in the device memory you need to switch the device to the "Storage" mode by the prolonged exposure (longer than 10 seconds) of the magnetic field (magnet proximity) on the Hall sensor.





Pulse inputs can be configured for work in the **"Security" mode** via the "Vega LoRaWAN Configurator" application. In this mode, the device does not count pulses at the "Security" input, but only monitors its status. Should the "Security" input trigger, the device is activated and sends an alarm message to the network.

The maximum possible frequency of sending alarm packets is one per 1 second.

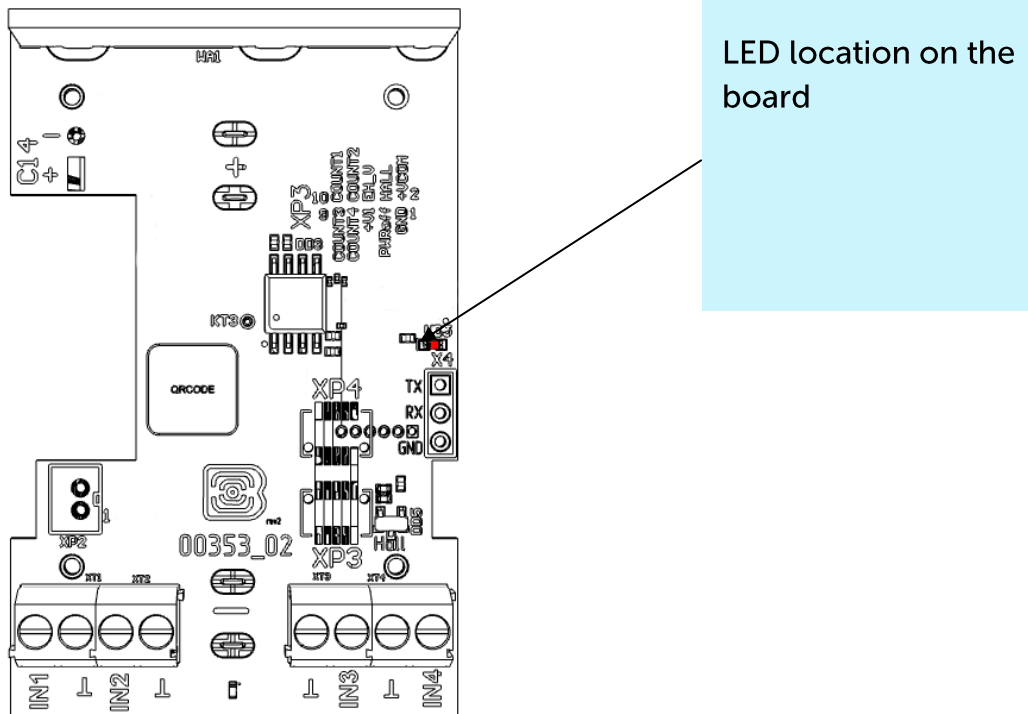
## LED INDICATIONS

There is one red LED on the board. The indication is only used when the device is activating in the LoRaWAN® network and when the operating modes are changing.



LED SIGNAL		MEANING
	Short flashings	Linking to the network in progress
	One long flashing during 5 sec	The device has been successfully connected to the network and is in active mode
	Three flashings each by 1 sec	Linking to the network has been failed or the device switched to the "Storage" mode
	One long flashing during 20 sec or until communication stops	Readiness for the start or activity of the communication session with the device via the FSK radio channel or the service UART connector



In case of connection attempt fail, the device will continue to accumulate data and will attempt to connect to the network every 6 hours

## HALL SENSOR

The device is equipped with a Hall sensor.

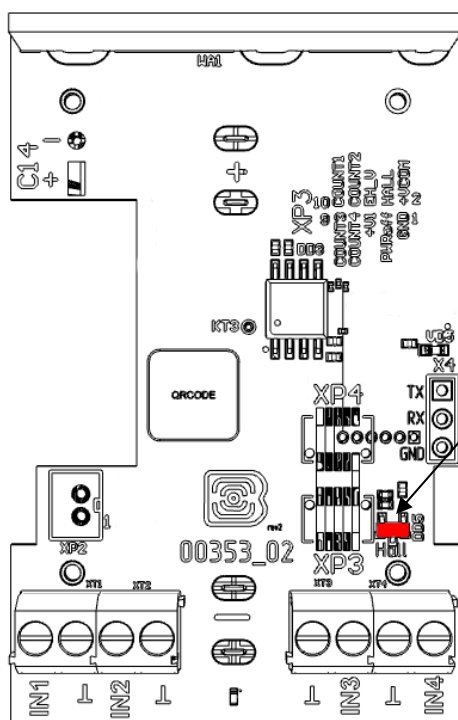

Hall sensor

DURATION OF MAGNET EXPOSURE	RESULT
10 seconds and longer	Turning on the device / switching to the "Storage" mode with resetting impulses
6..9 seconds	Starting the procedure of the network connection
1..2 seconds	Activation of connection to the device via FSK radio channel or service UART connector

## FSK RADIO CHANNEL

For a local wireless connection to a personal computer (PC), the device implements switching between LoRa and FSK modulation modes, that is, an FSK radio channel is implemented. To organize such a connection, an additional device "Vega FSK Dongle" is used, which is connected to the USB port of the PC. To read and change the meter parameters, the «Vega LoRaWAN Configurator» program is used.

## CONNECTING METER TO A PERSONAL COMPUTER

The FSK radio channel allows you to organize a local wireless (up to several tens of meters) connection to the meter for reading and changing its parameters.

To connect via FSK you will need:

- device "Vega FSK Dongle", which is connected to the USB port of a PC;
- FSK key, which is individual for each device and is contained in a QR code on a sticky label along with activation keys in the LoRaWAN® network and other identifiers.

The connection order is as follows:

1. Connect the "Vega FSK Dongle" to the USB port of the PC;
2. Run the «Vega LoRaWAN Configurator» program;
3. Click the "Connect" button in the menu on the left

The program will automatically recognize the device type and the device selection menu will become inactive.

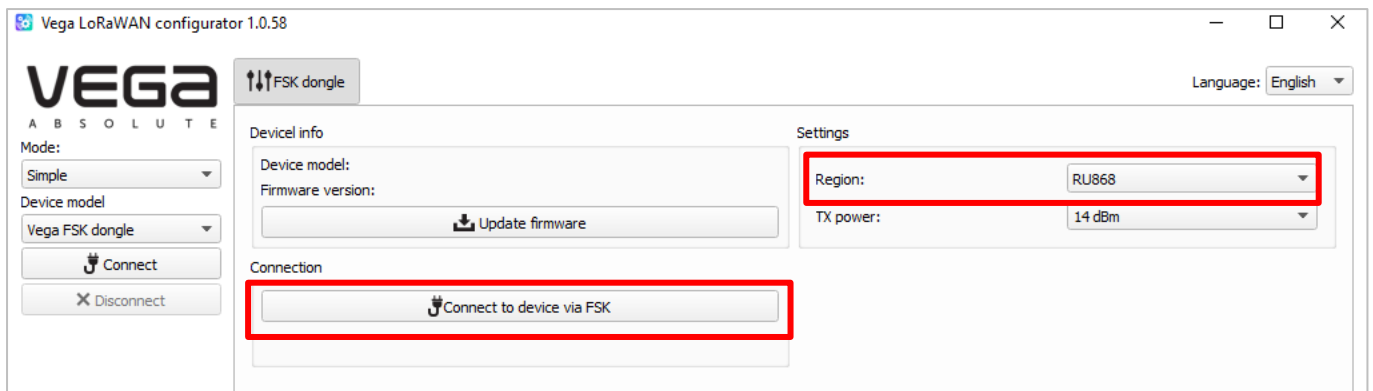

4. Click the "Get settings" button and make sure that the frequency plan matches the frequency plan of the device to which you plan to connect via FSK.
5. Click the "Connect to device via FSK" button.
6. In the window that appears, enter the FSK key of the desired meter and click "OK".

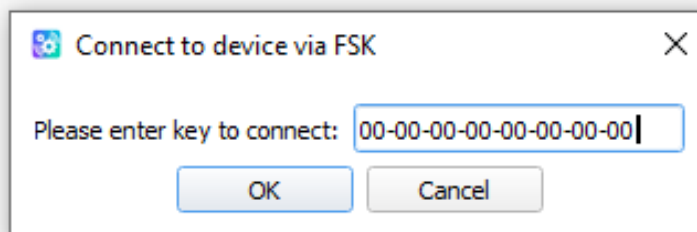

7. Exposure the magnet to the Hall sensor of the device for 1-2 seconds or wait for automatic connection (the device activates the FSK radio channel once every two minutes).

It will connect to the device as if it was connected via USB, only a window with FSK communication parameters will appear in the menu on the left. All settings are made, as with a USB connection, using the "Get Settings" and "Apply Settings" buttons.



At the time of an active communication session using the FSK radio channel, data transmission to the LoRaWAN® network will be unavailable. If the device settings have been changed, it will start the registration procedure on the network again, immediately after the session with the «Vega LoRaWAN Configurator» program is completed.

## CONNECTING METER TO A PERSONAL COMPUTER VIA VEGA USB-UART CONNECTOR

Vega USB-UART converter allows to organize a wired connection to the meter for reading and changing its parameters. To connect, it is necessary to install the driver for the MCP2200 COM port, which can be found [on website](#) in the "Downloads" section.

To connect you will need:

- Vega USB-UART converter connected to the USB port of a PC.

Connection procedure as follows:

1. Подключить «Вега USB-UART преобразователь» к сервисному UART-разъему на плате устройства.

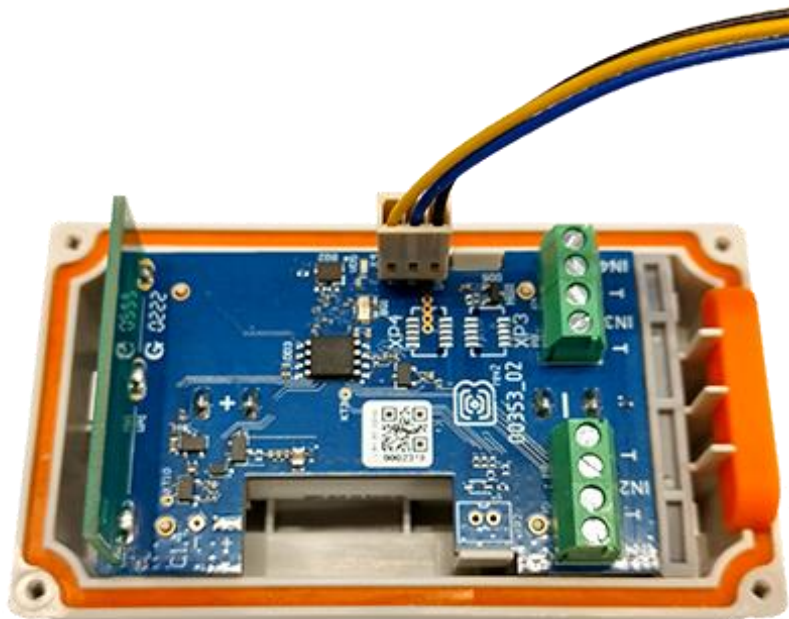

2. Connect the converter to the USB connector of a PC;
3. Run the «Vega LoRaWAN Configurator» program;
4. Expose the magnet to the Hall sensor and wait for the LED signal;
5. In the «Vega LoRaWAN Configurator» switch to the Expert mode in the menu on the left, select the device model and the assigned COM port. After that, click the "Connect" button.

## MOUNTING RECOMENDATIONS

To provide the stable radio between the gateway and the end device it is recommended avoiding the device installation in the places which are barriers for the radio signal getting through like a reinforced floors and walls, a basement, an underground facilities and wells, a metal case etc.

The necessary stage for the network deploying including a big quantity of end devices is a radio planning work with nature experiments.



**Before starting mounting work, you must make sure that the latest firmware version is installed on the equipment**

For mounting you will need:

- ⦿ cross-shaped screwdriver ;
- ⦿ awl;
- ⦿ wire stripper;
- ⦿ magnet;
- ⦿ laptop.



**Initially, the device is not connected to power, because a plastic plug is installed between the battery contact and the device contact, which must be removed before putting the sensor into operation  
After removing the plug, make sure that the battery contacts are tightly adjacent to the contacts of the device**

Plastic plug

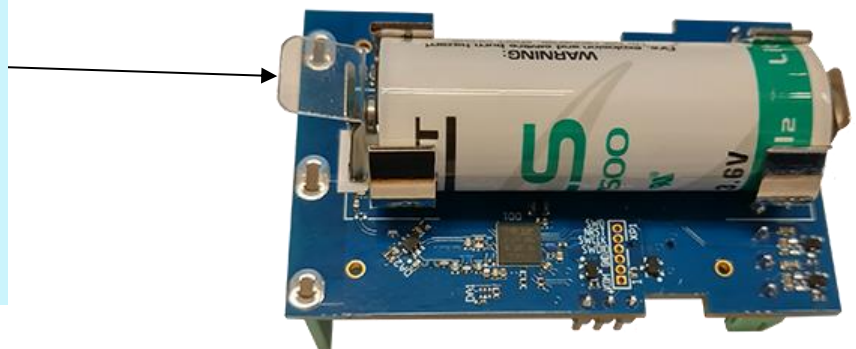

Step by step mounting is as follows:



1. Setting the devices and connecting them to the network are usually carried out in the office (see Network Deployment Manual).
2. Determination of suitable places for mounting at the object with a network tester.
3. De-energizing the connected equipment, metering devices, etc.
4. Making holes in the silicone gasket for wires - strictly according to the number of wires. **It must be remembered that the wire must be of circular cross-section and no more than 3 mm in diameter.**



**When removing the sealant, as well as when installing wires of a different diameter or cross-section, device performance may deteriorate until failure due to moisture entering the case**

5. Remove the plastic plug between the battery contact and the device contact if there is one, or install the battery if it was not installed;
6. Connecting all necessary wires to the SI-11 rev.2 contacts;
7. Device launching – switching to the “Active” mode by the prolonged exposure (longer than 10 seconds) of the magnetic field (magnet proximity) on the Hall sensor and registration in the network.

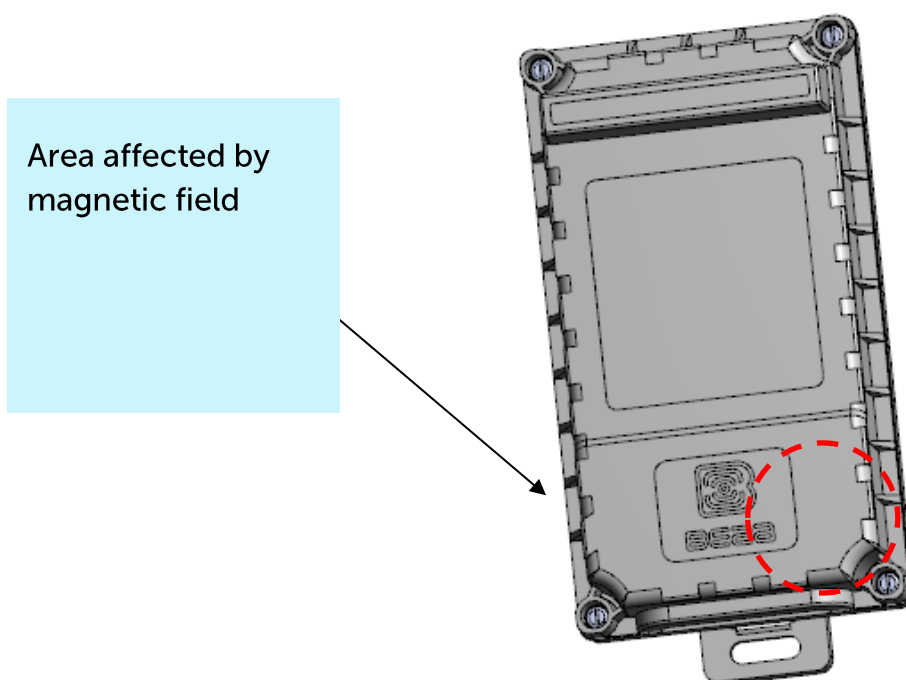

8. By the laptop you can make sure that the device successfully sends the data.
9. **Before assembling the device, it is necessary to reset the pulses accumulated during testing and connection by switching the device to the “Storage” mode by the prolonged exposure (longer than 10 seconds) of the magnetic field (magnet proximity) on the Hall sensor.**
10. Start the device by the prolonged exposure (longer than 10 seconds) of the magnetic field (magnet proximity) on the Hall sensor.
11. Assembling the device.
12. DIN-rail mounting or another available way to mount the device on the object.

## 4 COMMUNICATION PROTOCOL – VERSION 2.0

This part describes the latest version of the SI-11 rev.2 communication protocol with LoRaWAN® network. The protocol version of the device is displayed in the "Configurator" in the "Device info" tab



**In fields consisting of several bytes, the little endian byte order is used**

### VEGA SI-11 REV.2 PULSE COUNTER TRANSMITS THE FOLLOWING TYPES OF PACKETS

#### 1. Packet with current readings

Sent regularly or by event on LoRaWAN® port 2.

Size in bytes	Field description	Data type
1 byte	Packet type: 00 – transmission over time 01 – by security input 1 02 – by security input 2 03 – by security input 3 04 – by security input 4	uint8
1 byte	Battery charge, %	uint8
4 bytes	Reading time for values in this packet (unixtime UTC)	uint32
1 byte	Temperature, °C	int8
4 bytes	Input 1 reading (depending on the type – number of pulses or status: 0 – open, 1 - closed)	uint32
4 bytes	Input 2 reading (depending on the type – number of pulses or status: 0 – open, 1 - closed)	uint32
4 bytes	Input 3 reading (depending on the type – number of pulses or status: 0 – open, 1 - closed)	uint32
4 bytes	Input 4 reading (depending on the type – number of pulses or status: 0 – open, 1 - closed)	uint32
1 byte	Values of basic settings (bit field)	uint8

## "Values of basic settings" bit field decoding

Bit	Meaning
0 bit	Confirmed Uplinks: 0 - OFF, 1 - ON
1, 2,3 bits	Communication period:  1 == 0 2==0 3==0  - 5 minutes  1 == 1 2==0 3==0  - 15 minutes  1 == 0 2==1 3==0 - 30 minutes  1 == 1 2==1  3==0 - 1 hour  1 == 0 2==0 3==1 - 6 hours  1 == 1 2==0 3==1 - 12 hours  1 == 0 2==1 3==1 - 24 hours
4 bits	First input type: 0 - pulse, 1 - security
5 bits	Second input type: 0 - pulse, 1 - security
6 bits	Third input type: 0 - pulse, 1 - security
7 bits	Fourth input type: 0 - pulse, 1 - security

The counter has internal clock and calendar; time and date are factory set. When sending a packet with the current readings, the device uses the data taken at the nearest time, which is multiple to the interval according to data collection period:

- ⦿ 1 hour period: the readings of the beginning of the current hour are sent;
- ⦿ 6 hours period: 00:00, 06:00, 12:00, 18:00 readings are sent;
- ⦿ 12 hours period: 00:00, 12:00 readings are sent;
- ⦿ 24 hours period: the readings of 00:00 of the current day are sent.

Time zone considered during collection data from an external meter.

## 2. Settings packet

Transmitting on LoRaWAN® port 3 when settings request command received, or device connected to the network.

Size in bytes	Field description	Data type
1 byte	Packet type, this packet == 0	uint8
2 bytes	ID of parameter	uint16
1 byte	Data length (len)	uint8
len bytes	Parameter value	-----
2 bytes	ID of parameter	uint16
1 byte	Data length (len)	uint8
len bytes	Parameter value	-----
...	...	...
2 bytes	ID of parameter	uint16
1 byte	Data length (len)	uint8
len bytes	Parameter value	-----

**VEGA SI-11 REV.2 PULSE COUNTER RECEIVES PACKETS OF THE FOLLOWING TYPES**

## 1. Packet with request of settings

Sent by application on LoRaWAN® port 3.

Size in bytes	Field description	Data type
1 byte	Packet type, this packet == 1	uint8

Answering this packet, the device sends the packet with settings.

## 2. Packet with settings

Is identical to such packet from device.

Size in bytes	Field description	Data type
1 byte	Packet type, this packet == 0	uint8
2 bytes	ID of parameter	uint16
1 byte	Data length (len)	uint8
len bytes	Parameter value	-----
2 bytes	ID of parameter	uint16
1 byte	Data length (len)	uint8
len bytes	Parameter value	-----
...	...	...
2 bytes	ID of parameter	uint16
1 byte	Data length (len)	uint8
len bytes	Parameter value	-----

The package with settings sent to the device may not contain all the settings supported by the device, but only the part that needs to be changed.

Table of ID of SI-11 rev.2 parameters and these possible values



The table contains values in DEC, when sending, these values must be converted to HEX

ID of parameter	Description	Data length	Possible values
4	Confirmed uplinks	1 byte	1 – confirmed 2 – unconfirmed
8	Uplinks number of transmissions	1 byte	from 1 to 15
12	Input 1 mode	1 byte	1 – pulse 2 – guard
13	Input 2 mode	1 byte	1 – pulse 2 – guard
14	Input 3 mode	1 byte	1 – pulse 2 – guard
15	Input 4 mode	1 byte	1 – pulse 2 – guard
16	Communication period	1 byte	1 – 1 hour 2 – 6 hours 3 – 12 hours 4 – 24 hours 5 – 5 minutes 6 – 15 minutes 7 – 30 minutes
49	Data collection period	1 byte	1 – 1 hour 2 – 6 hours 3 – 12 hours 4 – 24 hours 5 – 5 minutes 6 – 15 minutes 7 – 30 minutes
55	Time zone, in minutes	2 bytes	from -720 to 840

## 5 STORAGE AND TRANSPORTATION REQUIREMENTS

Vega SI-11 rev.2 pulse counter shall be stored in the original packaging in heated room at temperatures +5 °C to +40 °C and relative humidity less than 85%.

The counter shall be transported in covered freight compartments of all types at any distance at temperatures -40 °C to +85 °C.

Long-term storage of the device in the "Storage" mode (more than 6 month) can lead to passivation of the battery.

## 6 CONTENT OF THE PACKAGE

The pulse counter is delivered complete with:

Vega SI-11 rev.2 pulse counter – 1 pc.

Screw – 4 pcs.

Factory certificate – 1 pc.

## 7 WARRANTY

The manufacturer guarantees that the product complies with the current technical documentation, subject to the storage, transportation and operation conditions specified in the "User Manual".

The warranty period is 36 months.

The warranty does not apply to batteries.

The warranty period of operation is calculated from the date of sale marked in the product factory certificate, and from the release date when such a mark is absent. During the warranty period, the manufacturer is obliged to provide repair services or replace a failed device or its components.

The manufacturer does not bear warranty obligations in the event of a product failure if:

- ⦿ the product does not have a factory certificate;
- ⦿ the factory certificate does not have an TCD stamp and / or there is no sticker with information about the device;
- ⦿ the serial number (DevEUI, EMEI) printed on the product differs from the serial number (DevEUI, EMEI) specified in the factory certificate;
- ⦿ the product has been subject to alterations in the design and / or software which are not provided for in the operational documentation;
- ⦿ the product has mechanical, electrical and / or other damage and defects arising from violation of the conditions of transportation, storage and operation;
- ⦿ the product has traces of repair outside the manufacturer's service center;
- ⦿ the components of the product have internal damage caused by the ingress of foreign objects / liquids and / or natural disasters (flood, fire, etc.).

The average service life of the product is 7 years.

In the event of a warranty claim, contact the service center:

119A, Bol'shevistskaya Str., Novosibirsk, 630009, Russia.

Tel.: +7 (383) 206-41-35.

e-mail: [remont@vega-absolute.ru](mailto:remont@vega-absolute.ru)



DOCUMENT INFORMATION	
Title	Pulse Counter Vega SI-11 rev.2
Document type	Manual – Translation from Russian
Document number	V02-SI11-01
Revision and date	30 of 23 August 2022

## Revision History

Revision	Date	Name	Comments
01	24.01.2017	KEV	Document creation date
02	26.01.2017	PKP	Little accuracies was removed
03	27.01.2017	PKP	Exchange protocol description was added
04	30.01.2017	KEV	General correction, formatting etc.
05	01.02.2017	KEV	The preface was added on the cover
06	07.03.2017	PKP	RU868 was added
07	17.03.2017	KEV	New photos, information about stickers, USB was added
08	14.04.2017	KEV	Minor edits
09	10.05.2017	KEV	New photos of the appearance
10	01.06.2017	PKP	Minor edits at the communication protocol
11	17.06.2017	PKP	Fixed error in archive request command
12	11.07.2017	PKP	Fixed error in protocol description
13	16.08.2017	PKP	Adding's in alarm command description
14	08.09.2017	KEV	Part "Vega LoRaWAN Configurator" was added
15	11.10.2017	KEV	Warranty was changed, minor edits
16	10.01.2018	KEV	Minor edits, new illustrations in the "Operation" part
17	04.05.2018	KEV	Edits concerning the field of application with meters with pulse outputs
18	24.07.2018	KEV	Changes in the device logic, removed switches, added frequency plans, changes in the communication protocol, in technical characteristics
19	03.09.2018	PKP KEV	Changes in the communication protocol. Timestamp is added to the alarm packet. Pulse input scheme is added.
20	22.01.2019	KEV	<a href="#">Communication protocol</a> changed, device <a href="#">setting "by the air"</a> added, <a href="#">device AppEui</a> added in specification, <a href="#">"Marking"</a> part added, other inaccuracies fixed
21	24.01.2019	KEV	Inaccuracy in <a href="#">communication protocol</a> fixed – packet type for packets with settings and request of settings
22	19.12.2019	KEV	Fixed inaccuracy about frequency of alarm packets generation, minor changes

23	08.04.2020	KEV	Fixed inaccuracy about data type in " <a href="#">Temperature</a> " field, minor changes
24	09.06.2020	KEV	The battery information is changed in the specification
25	24.06.2021	KEV	Scheduled revision of documentation. New <a href="#">warranty</a> conditions, new parts
26	25.08.2021	KEV	Elimination of inaccuracies
27	02.02.2022	KEV	The port for the packet with settings is specified
28	09.03.2022	KMA	New PC-board revision
29	05.05.2022	KMA	Minor edits
30	23.08.2022	KMA	Minor edits



[vega-absolute.ru](http://vega-absolute.ru)

User Manual © Vega-Absolute OOO 2022