



# **AEQ NETBOX 32 AD**

# **AEQ NETBOX 8 AD**

# **AEQ NETBOX DSP**

**AUDIO OVER IP MULTICHANNEL INTERFACES**

## **USER'S MANUAL**

**ED. 11/20**

V. 1.7 - 04/11/2024

<b>Firmware Versions:</b>	<b>NETBOX 32/8 AD:</b> CPU 1.37 / FPGA 1.06 / AoIP CPU 4.2.3.13 or higher
	<b>NETBOX DSP:</b> CPU 1.27 / FPGA 1.12 / DSP 1.09 / AoIP CPU 4.2.3.13 or higher
<b>Software Versions:</b>	<b>NetBox Tool</b> 2.0.0.19 or higher
	<b>NetBox RTC</b> 2.0.0.21 or higher
	<b>NetBox Server</b> 2.0.0.11 or higher

## CONTENTS

<b>1. INTRODUCTION.....</b>	<b>4</b>
1.1. Fields of application of the product. ....	4
1.2. Description of NETBOX 32 AD audio interface. ....	4
1.3. Description of NETBOX 8 AD audio interface. ....	4
1.4. Description of NETBOX DSP audio router. ....	5
<b>2. PHYSICAL DESCRIPTION OF THE UNITS. ....</b>	<b>6</b>
2.1. NETBOX 32 AD interface physical description.....	6
2.1.1. Description of the front panel. ....	6
2.1.2. Description of the back panel and connections. ....	7
2.1.2.1. Ethernet Ports (LAN 1 and LAN 2).....	7
2.1.2.2. Analog Inputs and Outputs. ....	7
2.1.2.3. Digital Inputs and Outputs.....	9
2.1.2.3.1. Digital inputs/outputs jumpers configuration. ....	10
2.1.2.4. General Purpose Inputs and Outputs (GPIO).....	14
2.1.2.5. Power supply.....	15
2.1.2.6. Remarks on NETBOX 32 AD audio wiring.....	15
2.2. NETBOX 8 AD interface physical description.....	15
2.2.1. Description of the front panel. ....	15
2.2.2. Description of the back panel and connections. ....	16
2.2.2.1. Ethernet Ports (LAN 1 and LAN 2).....	16
2.2.2.2. Analog Inputs and Outputs. ....	16
2.2.2.3. Digital Inputs and Outputs.....	17
2.2.2.3.1. Digital inputs/outputs jumpers configuration. ....	18
2.2.2.4. General Purpose Inputs and Outputs (GPIO).....	21
2.2.2.5. Power supply.....	21
2.2.2.6. Remarks on NETBOX 8 AD audio wiring.....	21
2.3. NETBOX DSP router physical description.....	21
2.3.1. Description of the front panel. ....	21
2.3.2. Description of the back panel and connections. ....	22
2.3.2.1. Ethernet Ports (LAN 1 and LAN 2).....	22
2.3.2.2. General Purpose Inputs (GPI). ....	23
2.3.2.3. General Purpose Outputs (GPO).....	24
2.3.2.4. Cooling fan. ....	24
2.3.2.5. Power supply.....	24
2.3.2.6. Remarks on NETBOX DSP GPIOs wiring. ....	24
<b>3. INSTALLATION AND USE OF APPLICATIONS.....</b>	<b>25</b>
3.1. PC Applications for configuration and control.....	25
3.2. "AEQ NetBox Tool": control and configuration software for NETBOX 8, NETBOX 32 and NETBOX DSP.....	25
3.2.1. Introduction. ....	25
3.2.2. Administration Tools. ....	26
3.2.2.1. "Configurations" submenu.....	27
3.2.2.2. "GPIO's" submenu. ....	31
3.2.2.3. "DIGITAL IO" submenu.....	32
3.2.2.4. "Remote IP" submenu.....	33
3.2.2.5. "Visual Radio" submenu.....	35
3.2.2.6. "Gains" submenu. ....	37
3.2.2.7. "About NetBox Tool" submenu. ....	39
3.2.3. Upgrading Tools.....	41
<b>4. TECHNICAL SPECIFICATIONS. ....</b>	<b>45</b>
<b>5. A.E.Q. GUARANTEE.....</b>	<b>48</b>
<b>APPENDIX 1. INSTALLATION OF A DANTE NETWORK WITH AEQ MIXING CONSOLES AND NETBOX.....</b>	<b>49</b>

A1.1. AEQ Audio over IP System for two digital studios and a Central Control. ....	49
A1.1.1. Installation.....	49
A1.1.2. Turning ON. ....	50
A1.1.3. Monitoring audio and creating routes. ....	50
A1.1.4. Optimization.....	50
A1.2. AEQ Audio over IP system for medium to large sized stations.....	50
<b>APPENDIX 2. ADDITIONAL INFORMATION. ....</b>	<b>53</b>

## 1. INTRODUCTION.

### 1.1. Fields of application of the product.

Using off-the-shelf routing equipment to send audio over IP in small to medium-sized systems offers cost advantages over synchronous solutions using AES-10 (MADI) or TDM buses. These have higher capacity, but require powerful hardware. Besides, large TDM systems can reduce their cost and at the same time increase their flexibility when they are combined with IP audio links to connect a few circuits with a central router.

That's why, when developing the IP audio routing system at AEQ, we have created not only IP connection devices for the consoles, but also connection panels that allow for audio input and output installation wherever it's necessary, as well as access boards for the AEQ X\_CORE router.

On the other hand, AEQ insists on offering interoperability with third party devices for the convenience of our customers. Because of that, the solution we now present is based on AUDINATE's technology that is operating with extraordinary performance, making our systems 100% compatible with a wide selection of equipment for Broadcast, Recording Studios and Professional Audio (see full listing at [www.audinate.com](http://www.audinate.com)).

Please consult the **AEQ AoIP user's manual** for more information.



Dante™ is a trademark of Audinate Pty Ltd.

Product includes license from Audinate Pty Ltd under US patent number(s) 7747725, 8005939, 7978696, 8171152 and others. Visit Audinate website for more details on Dante: <http://www.audinate.com/>

### 1.2. Description of NETBOX 32 AD audio interface.

**NETBOX 32 AD** is an interface for multi-channel AoIP. It allows you to insert and extract audio channels in a system based on DANTE technology, at locations where the installation of AEQ digital consoles is not planned. Due to its high input and output capacity, it is especially suitable for central controls and link dispatches and also to increase or distribute the capacity of TDM BUS matrices such as the AEQ X\_CORE.

NETBOX 32 AD features 32 input and 32 output channels organized in 16 mono analog and 8 stereo digital channels. The stereo digital audio channels can be configured as AES/EBU or SPDIF standard. It also incorporates 16 GPIs and 16 GPOs (each GPIO connector includes a power supply pin to feed the external circuitry), as well as 256 virtual GPIs and 256 virtual GPOs.

The unit can be turned into a 64x64 mixing and distributing audio **matrix** ("NETBOX 32 AD MX Audio Router 64x64") by mixing specific firmware versions, a user **license** and "**AEQ Netbox RTC**" application. Please consult section 3.2.2.1 of this manual and the user's manual of "**AEQ Netbox RTC**" application for more information.

The unit can be turned into a multichannel level detector for camera selection in **Visual Radio** systems ("NETBOX 32 AD VX") by means of a user **license**. Please consult section 3.2.2.1 of this manual for more information.

### 1.3. Description of NETBOX 8 AD audio interface.

**NETBOX 8 AD** is an interface for multi-channel AoIP. It allows you to insert and extract audio channels in a system based on DANTE technology, at locations where the installation of AEQ digital consoles is not planned. Due to its small footprint, it can be useful to give IP access to analog or digital consoles that are not ready for this type of connectivity from factory, for recording rooms, talk-rooms or any other auxiliary location.

NETBOX 8 AD features 8 inputs and 8 outputs, organized in 4 mono analog and 2 digital stereo channels. Stereo digital ones can be configured as AES/EBU or SPDIF standards. The second digital stereo channel can also be switched to a USB connector to ease the connection to an audio workstation. It also provides 4 GPIs and 4 GPOs (the GPIO connector includes a power supply pin to feed the external circuitry), as well as 256 virtual GPIs and 256 virtual GPOs.

The unit can be turned into a 16x16 mixing and distributing audio **matrix** ("NETBOX 8 AD MX Audio Router 16x16") by mixing specific firmware versions, a user **license** and "AEQ Netbox RTC" application. Please consult section 3.2.2.1 of this manual and the user's manual of "AEQ Netbox RTC" application for more information.

The unit can be turned into a multichannel level detector for camera selection in **Visual Radio** systems ("NETBOX 8 AD VX") by means of a user **license**. Please consult section 3.2.2.1 of this manual for more information.

#### 1.4. Description of NETBOX DSP audio router.

**NETBOX DSP** device is able to receive audio from the DANTE network and then return it, mixed and processed, to be used in another device or subsystem. It can also generate a test tone (1KHz) and vumeters of all the inputs and outputs.

There are **4 different versions** of NETBOX DSP: **NETBOX DSP 64**, **NETBOX DSP 96**, **NETBOX DSP 128** y **NETBOX DSP 160**, with **routing and mixing** capabilities on 64, 96, 128 or 160 inputs to any of the 64, 96, 128 or 160 outputs in the AoIP network, respectively. It's possible to add any quantity of inputs (up to 160 depending on the version) in any of the outputs. In addition, there is gain control for all the inputs, outputs and cross points and automatic gain control (AGC) for all the inputs and outputs. Any output can also be muted.

All 4 versions have the same **processing** capability on a maximum of 64 selectable inputs or outputs. The available processes are:

- Frequency: high-pass, low-pass and band-pass filters and 4-band parametric equalizer.
- Dynamics: compressor, expander, noise gate, limiter and DLP combinations.
- Delay.

It also incorporates 16 GPIs and 16 GPOs (each GPIO connector includes a power supply pin to feed the external circuitry), as well as 256 virtual GPIs and 256 virtual GPOs that can be transported through the IP network between compatible devices (this way, a GPI can drive the GPOs of other devices).

## 2. PHYSICAL DESCRIPTION OF THE UNITS.

In order to understand the installation and cabling process associated to each unit, first you need to be familiar with the connectors and other specific elements of the AoIP solution described in this manual and the equipment front and back panels.

### 2.1. NETBOX 32 AD interface physical description.

#### 2.1.1. Description of the front panel.

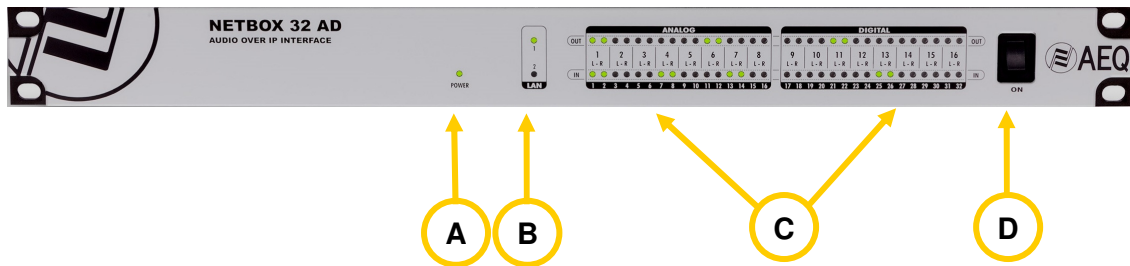

There are indicators related to the unit status, communications and audio levels.

- A POWER ON LED:** indicates the status of the unit power supply.
- Off: no mains input.
  - Green: power supply ON.
- B LAN LEDs:** indicate the status of the audio local area network: LAN 1 (main interface) and LAN 2 (secondary interface).
- Status:
- Off: no local network connection.
  - Blinking green: link is established at data level.
- If the boards are wired to a dedicated audio network using a switch, only LAN 1 should be blinking. If the wiring is connected in "Daisy Chain" mode, without switches, or there is a redundant network, both LEDs should be blinking.
- IMPORTANT NOTE:** When there is a redundant network, primary and secondary interfaces must be connected to separated networks.
- C AUDIO LEVEL LEDs:** Each LED indicates the level of the corresponding device audio input / output:
- LED off: the channel is muted, or transmits or receives (depending on whether it is an output or an input) at a level below -60dBFS.
  - Green LED: channel is transmitting or receiving audio (depending on whether it is an output or an input) at a level between -60dBFS and -20dBFS.
  - Amber LED: channel is transmitting or receiving audio (depending on whether it is an output or an input) at a level between -20dBFS and -6dBFS.
  - Red LED: the channel is saturated or "clipping" (above -6dBFS).
- D On / Off switch.**

## 2.1.2. Description of the back panel and connections.

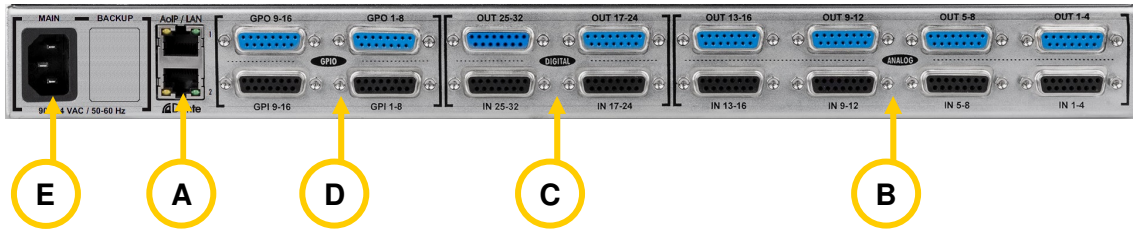

### 2.1.2.1. Ethernet Ports (LAN 1 and LAN 2). **A**

NETBOX 32 includes two Ethernet ports: LAN 1 must always be wired, while LAN 2 is only used when the system is wired in "Daisy Chain" mode or a redundant system is set up.

**IMPORTANT NOTE:** When there is a redundant network, primary and secondary interfaces must be connected to separated networks.

Physically, both are RJ45 10/100/1000, connectors, with the pinout described below:

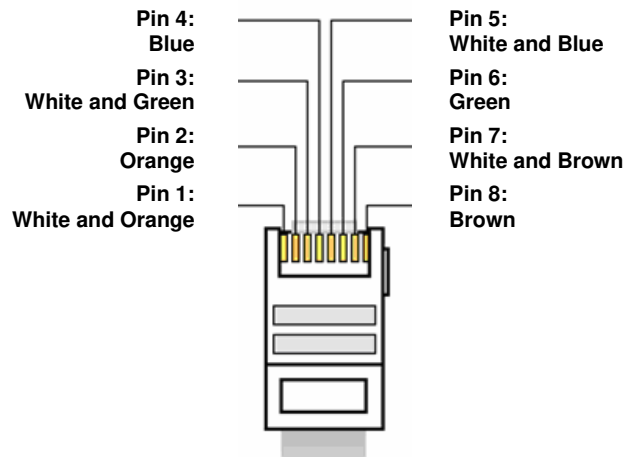

RJ45 connector pinout

### 2.1.2.2. Analog Inputs and Outputs. **B**

The physical connectors used are DB15-female. INPUTS (IN) connectors are placed in the bottom row while OUTPUTS (OUT) are located in the upper row, with the following pinout:

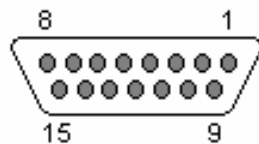

#### Pinout of DB15 ANALOG IN 1 - 4 connector

- |                        |                         |
|------------------------|-------------------------|
| - Pin 1: ANALOG 1 IN + | - Pin 9: ANALOG 1 IN -  |
| - Pin 2: GND           | - Pin 10: GND           |
| - Pin 3: ANALOG 2 IN + | - Pin 11: ANALOG 2 IN - |
| - Pin 4: GND           | - Pin 12: GND           |
| - Pin 5: ANALOG 3 IN + | - Pin 13: ANALOG 3 IN - |
| - Pin 6: GND           | - Pin 14: GND           |
| - Pin 7: ANALOG 4 IN + | - Pin 15: ANALOG 4 IN - |
| - Pin 8: GND           |                         |

Pinout of DB15 ANALOG IN 5 - 8 connector

- |                        |                         |
|------------------------|-------------------------|
| - Pin 1: ANALOG 5 IN + | - Pin 9: ANALOG 5 IN -  |
| - Pin 2: GND           | - Pin 10: GND           |
| - Pin 3: ANALOG 6 IN + | - Pin 11: ANALOG 6 IN - |
| - Pin 4: GND           | - Pin 12: GND           |
| - Pin 5: ANALOG 7 IN + | - Pin 13: ANALOG 7 IN - |
| - Pin 6: GND           | - Pin 14: GND           |
| - Pin 7: ANALOG 8 IN + | - Pin 15: ANALOG 8 IN - |
| - Pin 8: GND           |                         |

Pinout of DB15 ANALOG IN 9 - 12 connector

- |                         |                          |
|-------------------------|--------------------------|
| - Pin 1: ANALOG 9 IN +  | - Pin 9: ANALOG 9 IN -   |
| - Pin 2: GND            | - Pin 10: GND            |
| - Pin 3: ANALOG 10 IN + | - Pin 11: ANALOG 10 IN - |
| - Pin 4: GND            | - Pin 12: GND            |
| - Pin 5: ANALOG 11 IN + | - Pin 13: ANALOG 11 IN - |
| - Pin 6: GND            | - Pin 14: GND            |
| - Pin 7: ANALOG 12 IN + | - Pin 15: ANALOG 12 IN - |
| - Pin 8: GND            |                          |

Pinout of DB15 ANALOG IN 13 - 16 connector

- |                         |                          |
|-------------------------|--------------------------|
| - Pin 1: ANALOG 13 IN + | - Pin 9: ANALOG 13 IN -  |
| - Pin 2: GND            | - Pin 10: GND            |
| - Pin 3: ANALOG 14 IN + | - Pin 11: ANALOG 14 IN - |
| - Pin 4: GND            | - Pin 12: GND            |
| - Pin 5: ANALOG 15 IN + | - Pin 13: ANALOG 15 IN - |
| - Pin 6: GND            | - Pin 14: GND            |
| - Pin 7: ANALOG 16 IN + | - Pin 15: ANALOG 16 IN - |
| - Pin 8: GND            |                          |

Pinout of DB15 ANALOG OUT 1 - 4 connector

- |                         |                          |
|-------------------------|--------------------------|
| - Pin 1: ANALOG 1 OUT + | - Pin 9: ANALOG 1 OUT -  |
| - Pin 2: GND            | - Pin 10: GND            |
| - Pin 3: ANALOG 2 OUT + | - Pin 11: ANALOG 2 OUT - |
| - Pin 4: GND            | - Pin 12: GND            |
| - Pin 5: ANALOG 3 OUT + | - Pin 13: ANALOG 3 OUT - |
| - Pin 6: GND            | - Pin 14: GND            |
| - Pin 7: ANALOG 4 OUT + | - Pin 15: ANALOG 4 OUT - |
| - Pin 8: GND            |                          |

Pinout of DB15 ANALOG OUT 5 - 8 connector

- |                         |                          |
|-------------------------|--------------------------|
| - Pin 1: ANALOG 5 OUT + | - Pin 9: ANALOG 5 OUT -  |
| - Pin 2: GND            | - Pin 10: GND            |
| - Pin 3: ANALOG 6 OUT + | - Pin 11: ANALOG 6 OUT - |
| - Pin 4: GND            | - Pin 12: GND            |
| - Pin 5: ANALOG 7 OUT + | - Pin 13: ANALOG 7 OUT - |
| - Pin 6: GND            | - Pin 14: GND            |
| - Pin 7: ANALOG 8 OUT + | - Pin 15: ANALOG 8 OUT - |
| - Pin 8: GND            |                          |

Pinout of DB15 ANALOG OUT 9 - 12 connector

- |                          |                           |
|--------------------------|---------------------------|
| - Pin 1: ANALOG 9 OUT +  | - Pin 9: ANALOG 9 OUT -   |
| - Pin 2: GND             | - Pin 10: GND             |
| - Pin 3: ANALOG 10 OUT + | - Pin 11: ANALOG 10 OUT - |
| - Pin 4: GND             | - Pin 12: GND             |
| - Pin 5: ANALOG 11 OUT + | - Pin 13: ANALOG 11 OUT - |
| - Pin 6: GND             | - Pin 14: GND             |
| - Pin 7: ANALOG 12 OUT + | - Pin 15: ANALOG 12 OUT - |
| - Pin 8: GND             |                           |

#### Pinout of DB15 ANALOG OUT 13 - 16 connector

- Pin 1: ANALOG 13 OUT +
- Pin 2: GND
- Pin 3: ANALOG 14 OUT +
- Pin 4: GND
- Pin 5: ANALOG 15 OUT +
- Pin 6: GND
- Pin 7: ANALOG 16 OUT +
- Pin 8: GND
- Pin 9: ANALOG 13 OUT -
- Pin 10: GND
- Pin 11: ANALOG 14 OUT -
- Pin 12: GND
- Pin 13: ANALOG 15 OUT -
- Pin 14: GND
- Pin 15: ANALOG 16 OUT -

**IMPORTANT NOTE:** If you want to connect any of the outputs to an unbalanced input, you must unbalance the output, using the corresponding positive and GND pins and leaving the negative pin unconnected. Also keep in mind that unbalancing the output will reduce its level by 6dB.

#### 2.1.2.3. Digital Inputs and Outputs. C

The physical connectors used are DB15-female. INPUTS (IN) connectors are placed in the bottom row while OUTPUTS (OUT) are located in the upper row, with the following pinout:

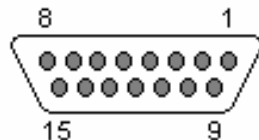

#### Pinout of DB15 DIGITAL IN 17 - 24 connector

- Pin 1: DIGITAL 17-18 IN +
- Pin 2: GND
- Pin 3: DIGITAL 19-20 IN +
- Pin 4: GND
- Pin 5: DIGITAL 21-22 IN +
- Pin 6: GND
- Pin 7: DIGITAL 23-24 IN +
- Pin 8: GND
- Pin 9: DIGITAL 17-18 IN -
- Pin 10: GND
- Pin 11: DIGITAL 19-20 IN -
- Pin 12: GND
- Pin 13: DIGITAL 21-22 IN -
- Pin 14: GND
- Pin 15: DIGITAL 23-24 IN -

#### Pinout of DB15 DIGITAL IN 25 - 32 connector

- Pin 1: DIGITAL 25-26 IN +
- Pin 2: GND
- Pin 3: DIGITAL 27-28 IN +
- Pin 4: GND
- Pin 5: DIGITAL 29-30 IN +
- Pin 6: GND
- Pin 7: DIGITAL 31-32 IN +
- Pin 8: GND
- Pin 9: DIGITAL 25-26 IN -
- Pin 10: GND
- Pin 11: DIGITAL 27-28 IN -
- Pin 12: GND
- Pin 13: DIGITAL 29-30 IN -
- Pin 14: GND
- Pin 15: DIGITAL 31-32 IN -

#### Pinout of DB15 DIGITAL OUT 17 - 24 connector

- Pin 1: DIGITAL 17-18 OUT +
- Pin 2: GND
- Pin 3: DIGITAL 19-20 OUT +
- Pin 4: GND
- Pin 5: DIGITAL 21-22 OUT +
- Pin 6: GND
- Pin 7: DIGITAL 23-24 OUT +
- Pin 8: GND
- Pin 9: DIGITAL 17-18 OUT -
- Pin 10: GND
- Pin 11: DIGITAL 19-20 OUT -
- Pin 12: GND
- Pin 13: DIGITAL 21-22 OUT -
- Pin 14: GND
- Pin 15: DIGITAL 23-24 OUT -

#### Pinout of DB15 DIGITAL OUT 25 - 32 connector

- |                              |                               |
|------------------------------|-------------------------------|
| - Pin 1: DIGITAL 25-26 OUT + | - Pin 9: DIGITAL 25-26 OUT -  |
| - Pin 2: GND                 | - Pin 10: GND                 |
| - Pin 3: DIGITAL 27-28 OUT + | - Pin 11: DIGITAL 27-28 OUT - |
| - Pin 4: GND                 | - Pin 12: GND                 |
| - Pin 5: DIGITAL 29-30 OUT + | - Pin 13: DIGITAL 29-30 OUT - |
| - Pin 6: GND                 | - Pin 14: GND                 |
| - Pin 7: DIGITAL 31-32 OUT + | - Pin 15: DIGITAL 31-32 OUT - |
| - Pin 8: GND                 |                               |

#### Remarks:

- Each of the eight digital audio inputs and outputs include two different audio channels, according to AES 3 or SPDIF standard.
- The first digital input (17-18) synchronizes NETBOX 32 with the source connected to it, emitting an AES 3/SPDIF or AES 11 formatted stream.
- The outputs can be used to provide synchronization to other devices that can extract it from an AES 3 formatted audio stream.

#### **2.1.2.3.1. Digital inputs/outputs jumpers configuration.**

**IMPORTANT NOTE:** Access and configuration of the configuration jumpers require a previous experience in installing and configuring computer or electronic cards. Don't open the unit if you lack this experience in order to avoid risk of electrical shock or damages to the system.



**Digital inputs and outputs** are programmed by default as **AES/EBU**. If compatibility with **SPDIF** equipment is required, you must open the unit and change the corresponding configuration jumpers.

- **Opening the unit.**  
It's **VERY IMPORTANT** to turn first the equipment off and disconnect the power supply cable. Remove the 12 screws located at the top cover. Pull up from the top cover and remove it.
- **Finding the jumpers location.**  
Place the unit with the connectors facing towards you and recognize the following zones inside it:

**5 TO 8 (25 TO 32) DIGITAL INPUTS AND OUTPUTS  
PROGRAMMING ZONE**

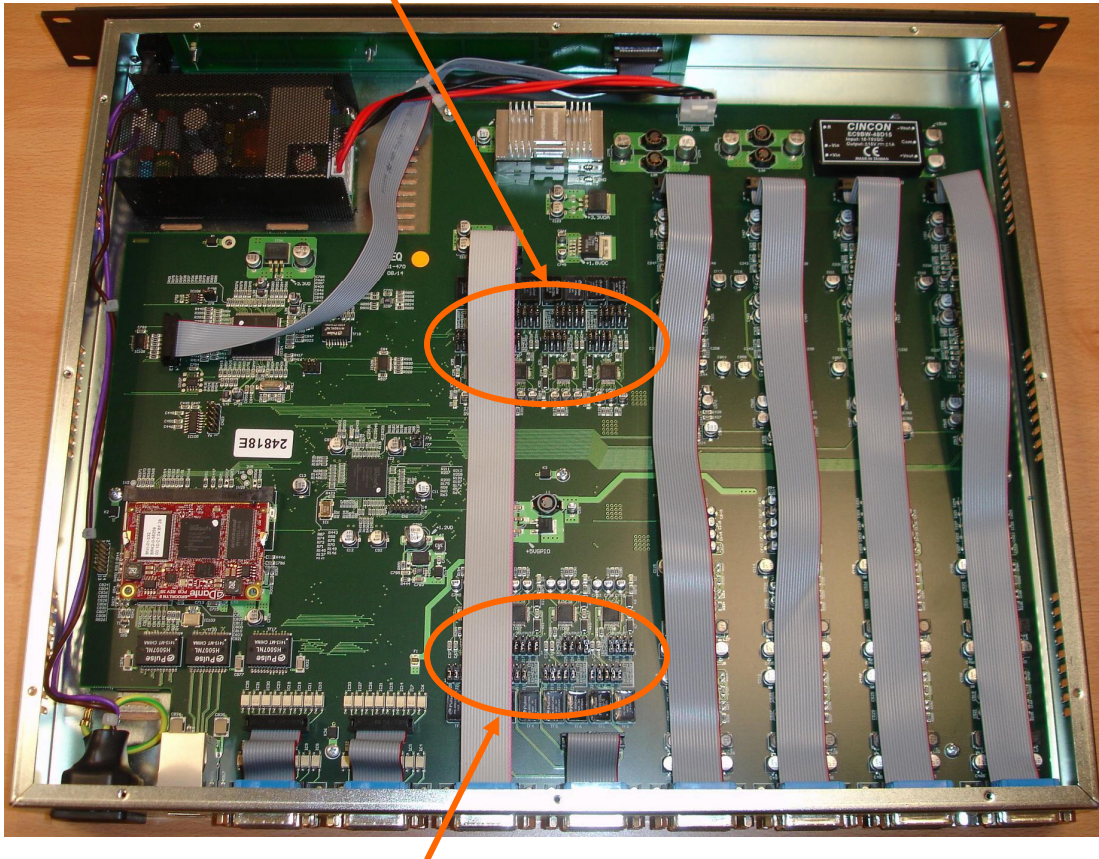

**1 TO 4 (17 TO 24) DIGITAL INPUTS AND OUTPUTS  
PROGRAMMING ZONE**

- **Programming digital outputs 1 to 4 as S/PDIF.**

In order to provide outputs to S/PDIF equipments, the programming procedure described below adapts the levels and unbalances the signals by joining OUT1-, OUT2-, OUT3- and OUT4- to their corresponding GND, so the signal is taken from each OUT+ to OUT- (or GND).

At the "1 TO 4 DIGITAL INPUTS AND OUTPUTS PROGRAMMING ZONE", you can change the outputs one by one from AES/EBU to S/PDIF by moving the 4 jumpers associated to each output from position 1-2 (down) to position 2-3 (up), as shown in the following image:

Position 1-2: AES/EBU  
Position 2-3: SPDIF

**Digital output 4**  
Jumpers J30, J31,  
J36 and J35

**Digital output 3**  
Jumpers J8, J17  
J18 and J16

**Digital output 2**  
Jumpers J25, J26,  
J34 and J33

**Digital output 1**  
Jumpers J3, J13,  
J14 and J12

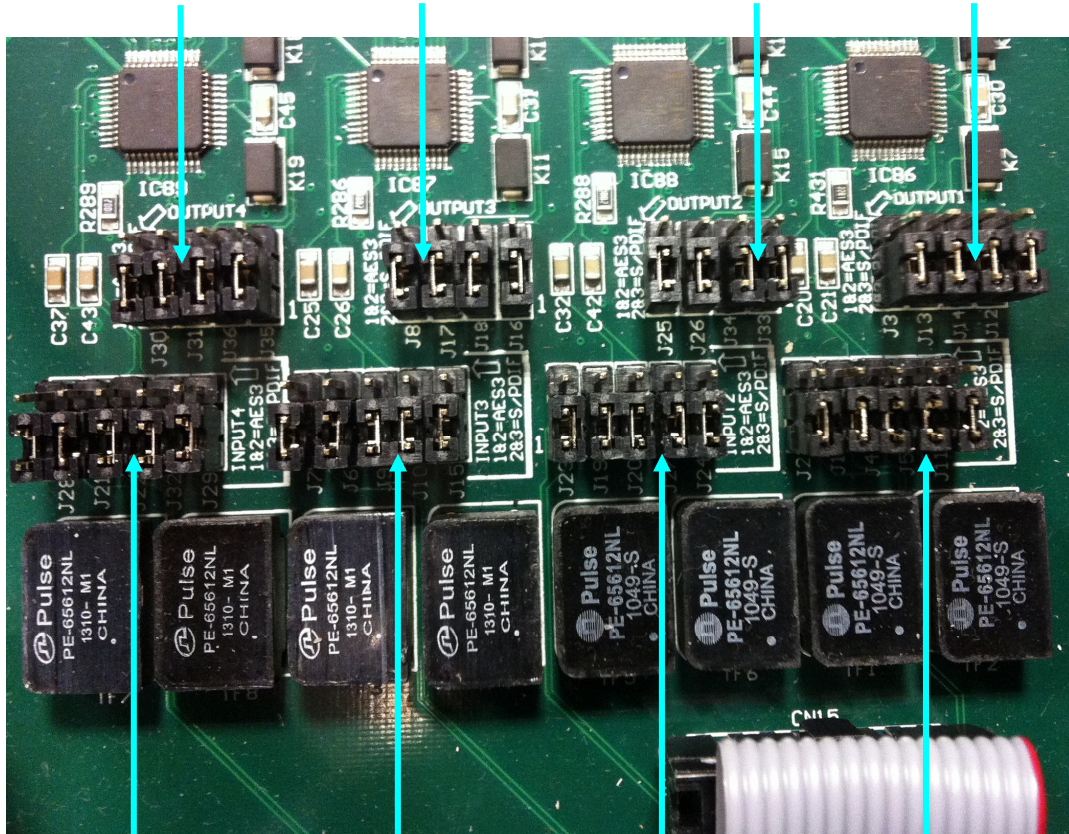

**Digital input 4**  
Jumpers J28, J21, J22,  
J32 and J29

**Digital input 3**  
Jumpers J7, J6, J9,  
J10 and J15

**Digital input 2**  
Jumpers J23, J19, J20,  
J27 and J24

**Digital input 1**  
Jumpers J2, J1, J4,  
J5 and J11

Position 1-2: AES/EBU  
Position 2-3: S/PDIF

- **Programming digital inputs 1 to 4 as S/PDIF.**

In order to use S/PDIF inputs, the programming described above adapts levels and unbalance signals by joining IN1-, IN2-, IN3- and IN4- to their associated grounds, so each signal is taken from the corresponding IN+ and its GND (or IN-).

At the "1 TO 4 DIGITAL INPUTS AND OUTPUTS PROGRAMMING ZONE", you can change the inputs one by one from AES/EBU to S/PDIF by moving the 5 jumpers associated to each input from position 1-2 (down) to position 2-3 (up), as shown in the previous image.

- **Programming digital inputs 5 to 8 as S/PDIF.**

In order to use S/PDIF inputs, the programming described below adapts levels and unbalance signals by joining IN5-, IN6-, IN7- and IN8- to their associated grounds, so each signal is taken from the corresponding IN+ and its GND (or IN-).

At the "5 TO 8 DIGITAL INPUTS AND OUTPUTS PROGRAMMING ZONE", you can change the inputs one by one from AES/EBU to S/PDIF by moving the 5 jumpers associated to each input from position 1-2 (up) to position 2-3 (down), as shown in the following image:

Position 1-2: AES/EBU  
Position 2-3: S/PDIF

**Digital input 8**  
Jumpers J65, J68, J58, J57 and J64

**Digital input 7**  
Jumpers J51, J46, J45, J42 and J43

**Digital input 6**  
Jumpers J60, 63, J56, J55 and J59

**Digital input 5**  
Jumpers J47, J41, J40, J37 and J38

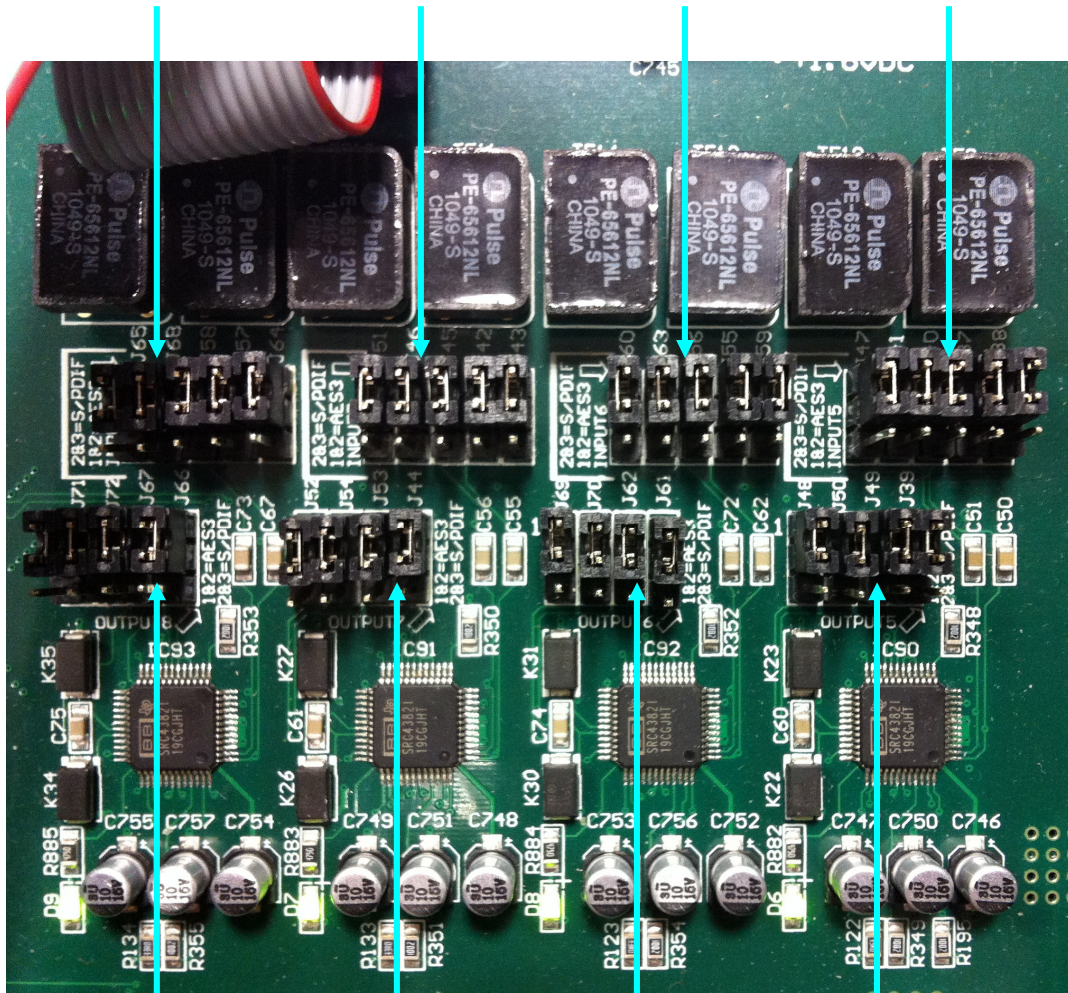

**Digital output 8**  
Jumpers J71, J72, J67 and J66

**Digital output 7**  
Jumpers J52, J54 J53 and J44

**Digital output 6**  
Jumpers J69, J70, J62 and J61

**Digital output 5**  
Jumpers J48, J50, J49 and J39

Position 1-2: AES/EBU  
Position 2-3: S/PDIF

- **Programming digital outputs 5 to 8 as S/PDIF.**

In order to provide outputs to S/PDIF equipments, the programming procedure described above adapts the levels and unbalances the signals by joining OUT5-, OUT6-, OUT7- and OUT8- to their corresponding GND, so the signal is taken from each OUT+ to OUT- (or GND).

At the "5 TO 8 DIGITAL INPUTS AND OUTPUTS PROGRAMMING ZONE", you can change the outputs one by one from AES/EBU to S/PDIF by moving the 4 jumpers associated to each output from position 1-2 (up) to position 2-3 (down), as shown in the previous image.

#### 2.1.2.4. General Purpose Inputs and Outputs (GPIO).

**D**

The physical connectors used are DB15-female. INPUTS (GPI) connectors are placed in the bottom row while OUTPUTS (GPO) are located in the upper row, with the following pinout:

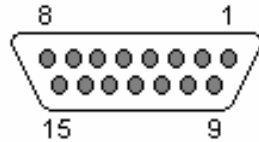

##### Pinout of DB15 GPI 1 - 8 connector

- |                |                       |
|----------------|-----------------------|
| - Pin 1: GPI 1 | - Pin 9: GND_GPI 1-4  |
| - Pin 2: GPI 2 | - Pin 10: GND_GPI 1-4 |
| - Pin 3: GPI 3 | - Pin 11: GND_GPI 1-4 |
| - Pin 4: GPI 4 | - Pin 12: +5V GPIO    |
| - Pin 5: GPI 5 | - Pin 13: GND_GPI 5-8 |
| - Pin 6: GPI 6 | - Pin 14: GND_GPI 5-8 |
| - Pin 7: GPI 7 | - Pin 15: GND_GPI 5-8 |
| - Pin 8: GPI 8 |                       |

Remarks: please note that a common ground (GND) is provided for inputs 1 to 4 and another one exists for inputs 5 to 8. Pin 12 supplies a +5V reference voltage to ease wiring.

##### Pinout of DB15 GPI 9 - 16 connector

- |                 |                         |
|-----------------|-------------------------|
| - Pin 1: GPI 9  | - Pin 9: GND_GPI 9-12   |
| - Pin 2: GPI 10 | - Pin 10: GND_GPI 9-12  |
| - Pin 3: GPI 11 | - Pin 11: GND_GPI 9-12  |
| - Pin 4: GPI 12 | - Pin 12: +5V GPIO      |
| - Pin 5: GPI 13 | - Pin 13: GND_GPI 13-16 |
| - Pin 6: GPI 14 | - Pin 14: GND_GPI 13-16 |
| - Pin 7: GPI 15 | - Pin 15: GND_GPI 13-16 |
| - Pin 8: GPI 16 |                         |

Remarks: please note that a common ground (GND) is provided for inputs 9 to 12 and another one exists for inputs 13 to 16. Pin 12 supplies a +5V reference voltage to ease wiring.

##### Pinout of DB15 GPO 1 - 8 connector

- |                |                       |
|----------------|-----------------------|
| - Pin 1: GPO 1 | - Pin 9: GND_GPO 1-4  |
| - Pin 2: GPO 2 | - Pin 10: GND_GPO 1-4 |
| - Pin 3: GPO 3 | - Pin 11: GND_GPO 1-4 |
| - Pin 4: GPO 4 | - Pin 12: +5V GPIO    |
| - Pin 5: GPO 5 | - Pin 13: GND_GPO 5-8 |
| - Pin 6: GPO 6 | - Pin 14: GND_GPO 5-8 |
| - Pin 7: GPO 7 | - Pin 15: GND_GPO 5-8 |
| - Pin 8: GPO 8 |                       |

Remarks: please note that a common ground (GND) is provided for inputs 1 to 4 and another one exists for inputs 5 to 8. Pin 12 supplies a +5V reference voltage to ease wiring.

##### Pinout of DB15 GPO 9 - 16 connector

- |                 |                         |
|-----------------|-------------------------|
| - Pin 1: GPO 9  | - Pin 9: GND_GPO 9-12   |
| - Pin 2: GPO 10 | - Pin 10: GND_GPO 9-12  |
| - Pin 3: GPO 11 | - Pin 11: GND_GPO 9-12  |
| - Pin 4: GPO 12 | - Pin 12: +5V GPIO      |
| - Pin 5: GPO 13 | - Pin 13: GND_GPO 13-16 |
| - Pin 6: GPO 14 | - Pin 14: GND_GPO 13-16 |
| - Pin 7: GPO 15 | - Pin 15: GND_GPO 13-16 |
| - Pin 8: GPO 16 |                         |

Remarks: please note that a common ground (GND) is provided for inputs 9 to 12 and another one exists for inputs 13 to 16. Pin 12 supplies a +5V reference voltage to ease wiring.

### 2.1.2.5. Power supply. E

The mains power supply connector is located in the back left area of the unit. The internal power supply is auto ranging, accepting: 90 - 132 V AC & 187 - 264 V AC, 47-63Hz. Optionally, a second (backup) power supply can be installed in order to have redundancy.

### 2.1.2.6. Remarks on NETBOX 32 AD audio wiring.

AEQ eases the installation task providing the connection between the system and the connected pieces of equipment by providing on demand the "FR CAB INP" wiring accessory, consisting on a DB15 male connected to four balanced and shielded pairs, 6 meters long, unterminated, in order to ease the wiring of 4 audio pairs.



The "CP CAB GPIO" accessory consists on a DB15 male connector connected to a 15-way wire, 6 meters long, unterminated, for GPIs and GPOs. Each cable allows you to connect the 8 GPIs or GPOs provided by each connector.



## 2.2. NETBOX 8 AD interface physical description.

### 2.2.1. Description of the front panel.

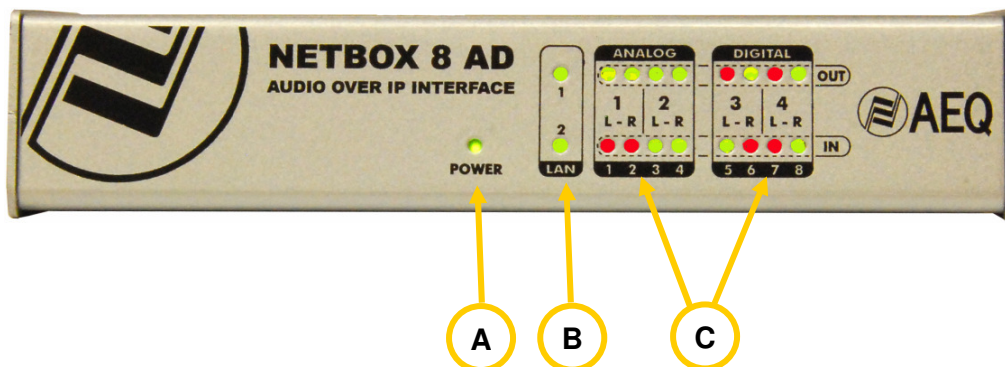

There are indicators related to the unit status, communications and audio levels.

- A **POWER ON LED:** indicates the status of the unit power supply:
  - Off: no mains input.
  - Green: power supply ON.

- B **LAN LEDs:** indicate the status of the audio local area network: LAN 1 (main interface) and LAN 2 (secondary interface):
  - Off: no local network connection.
  - Blinking green: link is established at data level.

If the boards are wired to a dedicated audio network using a switch, only LAN 1 should be blinking. If the wiring is connected in "Daisy Chain" mode, without switches, or there is a redundant network, both LEDs should be blinking. **IMPORTANT NOTE:** When there is a redundant network, primary and secondary interfaces must be connected to separated networks.

- C **AUDIO LEVEL LEDs:** Each LED indicates the level of the corresponding device audio input / output:

- LED off: the channel is muted, or transmits or receives (depending on whether it is an output or an input) at a level below -60dBFS.
- Green LED: channel is transmitting or receiving audio (depending on whether it is an output or an input) at a level between -60dBFS and -20dBFS.
- Amber LED: channel is transmitting or receiving audio (depending on whether it is an output or an input) at a level between -20dBFS and -6dBFS.
- Red LED: the channel is saturated or "clipping" (above -6dBFS).

## 2.2.2. Description of the back panel and connections.

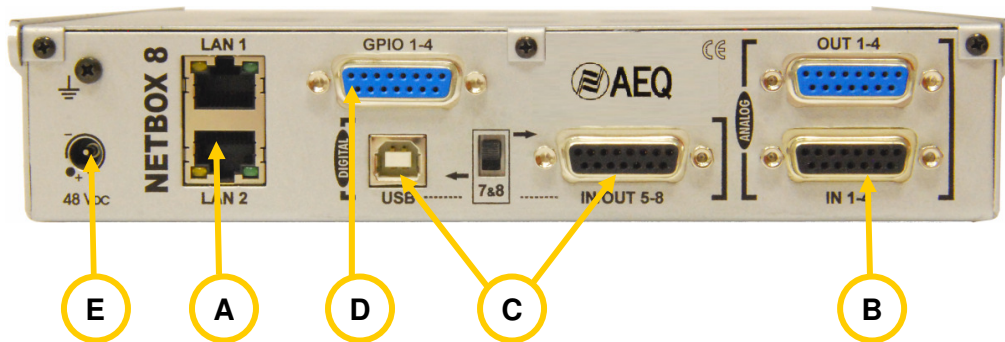

### 2.2.2.1. Ethernet Ports (LAN 1 and LAN 2). A

NETBOX 8 includes two Ethernet ports: LAN 1 must always be wired, while LAN 2 is only used when the system is wired in "Daisy Chain" mode or a redundant system is set up.

**IMPORTANT NOTE:** When there is a redundant network, primary and secondary interfaces must be connected to separated networks.

Physically, both are RJ45 10/100/1000, connectors, with the pinout described below:

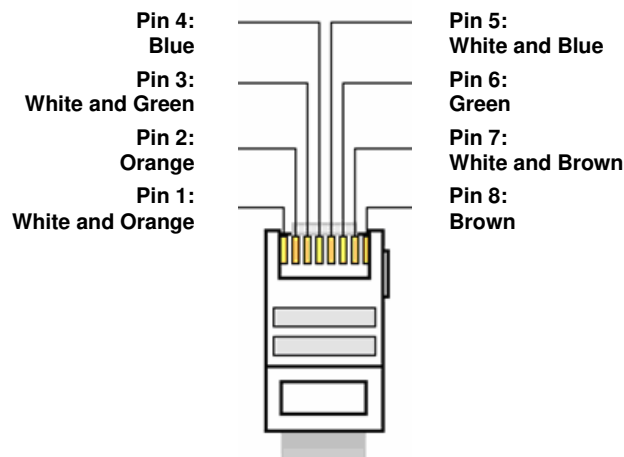

### 2.2.2.2. Analog Inputs and Outputs. B

The physical connectors used are DB15-female. INPUTS (IN) connector is placed in the bottom row while OUTPUTS (OUT) is located in the upper row, with the following pinout:

#### Pinout of DB15 ANALOG IN 1 - 4 connector

- |                        |                         |
|------------------------|-------------------------|
| - Pin 1: ANALOG 1 IN + | - Pin 9: ANALOG 1 IN -  |
| - Pin 2: GND           | - Pin 10: GND           |
| - Pin 3: ANALOG 2 IN + | - Pin 11: ANALOG 2 IN - |
| - Pin 4: GND           | - Pin 12: GND           |
| - Pin 5: ANALOG 3 IN + | - Pin 13: ANALOG 3 IN - |
| - Pin 6: GND           | - Pin 14: GND           |
| - Pin 7: ANALOG 4 IN + | - Pin 15: ANALOG 4 IN - |
| - Pin 8: GND           |                         |

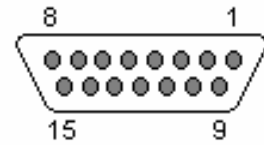

#### Pinout of DB15 ANALOG OUT 1 - 4 connector

- |                         |                          |
|-------------------------|--------------------------|
| - Pin 1: ANALOG 1 OUT + | - Pin 9: ANALOG 1 OUT -  |
| - Pin 2: GND            | - Pin 10: GND            |
| - Pin 3: ANALOG 2 OUT + | - Pin 11: ANALOG 2 OUT - |
| - Pin 4: GND            | - Pin 12: GND            |
| - Pin 5: ANALOG 3 OUT + | - Pin 13: ANALOG 3 OUT - |
| - Pin 6: GND            | - Pin 14: GND            |
| - Pin 7: ANALOG 4 OUT + | - Pin 15: ANALOG 4 OUT - |
| - Pin 8: GND            |                          |

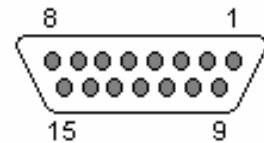

**IMPORTANT NOTE:** If you want to connect any of the outputs to an unbalanced input, you must unbalance the output, using the corresponding positive and GND pins and leaving the negative pin unconnected. Also keep in mind that unbalancing the output will reduce its level by 6dB.

### 2.2.2.3. Digital Inputs and Outputs. C

The physical connector used is DB15-female. In addition, there is a switch ("7&8") to assign the second digital input and output to that DB15 female connector or, alternatively, to a USB connector.

This way, when the switch is in the upper position, the DB15 female connector will include the 2 INPUTS (IN) and the 2 OUTPUTS (OUT), using the following pinout:

#### Pinout of DB15 DIGITAL IN/OUT 5-8 connector

- |                           |                             |
|---------------------------|-----------------------------|
| - Pin 1: DIGITAL 5-6 IN + | - Pin 9: DIGITAL 5-6 IN -   |
| - Pin 2: GND              | - Pin 10: GND               |
| - Pin 3: DIGITAL 5-6 OUT+ | - Pin 11: DIGITAL 5-6 OUT - |
| - Pin 4: GND              | - Pin 12: GND               |
| - Pin 5: DIGITAL 7-8 IN + | - Pin 13: DIGITAL 7-8 IN -  |
| - Pin 6: GND              | - Pin 14: GND               |
| - Pin 7: DIGITAL 7-8 OUT+ | - Pin 15: DIGITAL 7-8 OUT - |
| - Pin 8: GND              |                             |

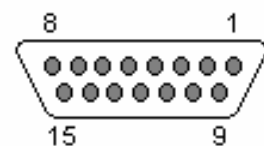

#### Remarks:

- Each of the two digital audio inputs and outputs include two different audio channels, according to AES 3 or SPDIF standard. The second one has also two channels in USB connector when the switch is in the lower position.
- The first digital input (5-6) synchronizes NETBOX 8 with the source connected to it, emitting an AES 3/SPDIF or AES 11 formatted stream.
- The outputs can be used to provide synchronization to other devices that can extract it from an AES 3 formatted audio stream.

## USB Digital input and output 2 (7-8).

When the rear switch is in the lower position, AEQ NETBOX 8 provides the second stereo digital input through the USB type-B connector labeled "USB". **NOTE:** The second output is always available through the DB15 connector as well as through the USB connector, regardless of the switch position.

When connecting the USB module to a PC through the USB port, the PC automatically recognizes it as a new audio device (identified as "USB Audio CODEC"). Audio can be sent to it from any playback program, like with any other professional external soundcard. Also, audio can be recorded from NETBOX by using any recording application. The card is "plug&play" on Microsoft Windows™ operating systems and Apple Computer Mac OS™, not requiring any special driver.

The supported sampling rates are 32 KHz, 44.1 KHz y 48 KHz, with internal Sample Rate Converter (SRC) to the 48 KHz frequency used internally by the DANTE-based AoIP AEQ system.

### 2.2.2.3.1. Digital inputs/outputs jumpers configuration.

**IMPORTANT NOTE:** Access and configuration of the configuration jumpers require a previous experience in installing and configuring computer or electronic cads. Don't open the unit if you lack this experience in order to avoid risk of electrical shock or damages to the system.



**Digital inputs and outputs** are programmed by default as **AES/EBU**. If compatibility with **SPDIF** equipment is required, you must open the unit and change the corresponding configuration jumpers.

- **Opening the unit.**  
It's **VERY IMPORTANT** to turn first the equipment off and disconnect the power supply cable. Remove the 3 screws located at the top of the rear panel and the 3 one located at the front of the unit's base. Pull up from the top cover and remove it.
- **Finding the jumpers location.**  
Place the unit with the front facing towards you and recognize the following zone inside it:



**DIGITAL INPUTS AND OUTPUTS PROGRAMMING ZONE**

- **Programming digital inputs 1 and 2 as S/PDIF.**

In order to use S/PDIF inputs, the programming described below adapts levels and unbalance signals by joining IN1- and IN2- to their associated grounds, so each signal is taken from the corresponding IN+ and its GND (or IN-). Take note that when the rear switch is in USB position, the digital input 2 will be placed at the USB connector regardless of the configuration programmed by jumpers.

At the "DIGITAL INPUTS AND OUTPUTS PROGRAMMING ZONE", you can change the inputs one by one from AES/EBU to S/PDIF by moving the 5 jumpers associated to each input from position 1-2 (up) to position 2-3 (down), as shown in the following image:

Position 1-2: AES/EBU  
Position 2-3: S/PDIF

**Digital input 1**  
Jumpers J7, J10, J5,  
J4 and J6

**Digital input 2**  
Jumpers J17, J16, J15,  
J13 and J14

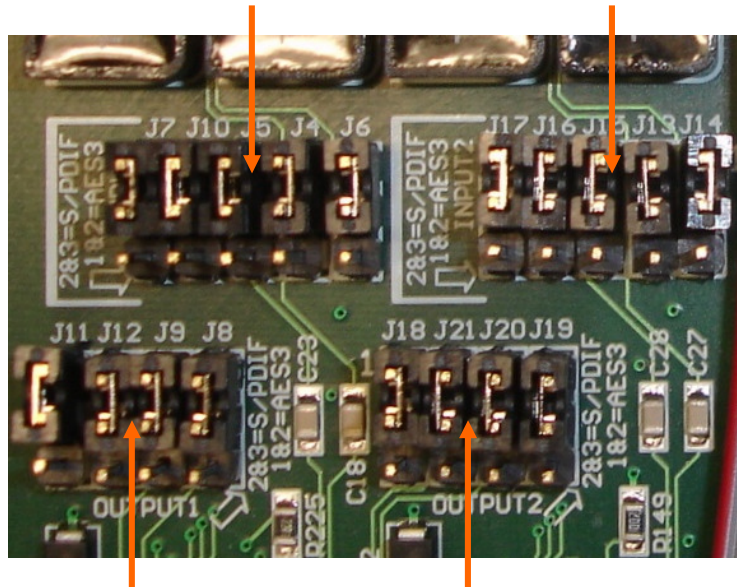

**Digital output 1**  
Jumpers J11, J12,  
J9 and J8

**Digital output 2**  
Jumpers J18, J21,  
J20 and J19

Position 1-2: AES/EBU  
Position 2-3: S/PDIF

- **Programming digital outputs 1 and 2 as S/PDIF.**

In order to provide outputs to S/PDIF equipments, the programming procedure described above adapts the levels and unbalances the signals by joining OUT1- and OUT2- to their corresponding GND, so the signal is taken from each OUT+ to OUT- (or GND). Take note that the digital output 2 will be duplicated at the USB connector regardless of the configuration programmed by jumpers.

At the "DIGITAL INPUTS AND OUTPUTS PROGRAMMING ZONE", you can change the outputs one by one from AES/EBU to S/PDIF by moving the 4 jumpers associated to each output from position 1-2 (up) to position 2-3 (down), as shown in the previous image.

### 2.2.2.4. General Purpose Inputs and Outputs (GPIO). D

The physical connector used is DB15-female, with the following pinout:

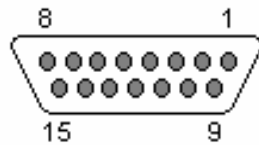

- |                |                        |
|----------------|------------------------|
| - Pin 1: GPI 1 | - Pin 9: GND_GPI 1-4   |
| - Pin 2: GPI 2 | - Pin 10: GND_GPI 1-4  |
| - Pin 3: GPI 3 | - Pin 11: GND_GPI 1-4  |
| - Pin 4: GPI 4 | - Pin 12: +5V GPIO 1-4 |
| - Pin 5: GPO 1 | - Pin 13: GND_GPO 1-4  |
| - Pin 6: GPO 2 | - Pin 14: GND_GPO 1-4  |
| - Pin 7: GPO 3 | - Pin 15: GND_GPO 1-4  |
| - Pin 8: GPO 4 |                        |

Remarks: please note that a common ground (GND) is provided for inputs and another one exists for outputs. Pin 12 supplies a +5V reference voltage to ease wiring.

### 2.2.2.5. Power supply. E

The connector for external 48V DC adapter is located in the back left area of the unit. The provided universal mains adapter operates from 90 to 264 V AC, 47-63Hz.

### 2.2.2.6. Remarks on NETBOX 8 AD audio wiring.

AEQ eases the installation task providing the connection between the system and the connected pieces of equipment by providing on demand the "**FR CAB INP**" wiring accessory, consisting on a DB15 male connected to four balanced and shielded pairs, 6 meters long, unterminated, in order to ease the wiring of 4 audio pairs.



The "**CP CAB GPIO**" accessory consists on a DB15 male connector connected to a 15-way wire, 6 meters long, unterminated, for GPIs and GPOs. Each cable allows you to connect the GPIs or GPOs provided by the unit.



## 2.3. NETBOX DSP router physical description.

### 2.3.1. Description of the front panel.

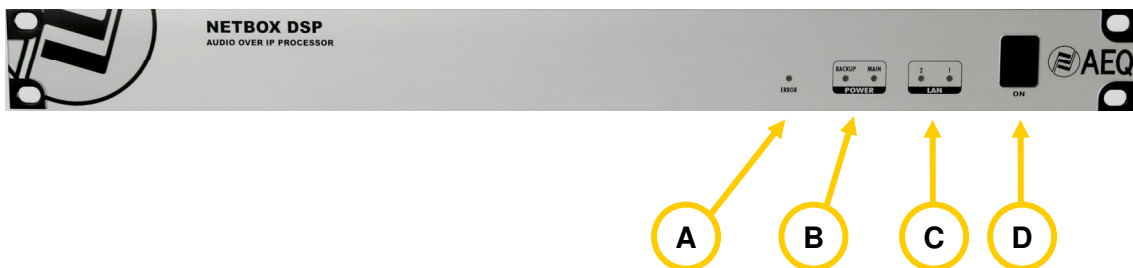

There are indicators related to the unit status and communications.

- A** **ERROR LED:** indicates the initialization status or a hardware error of the unit
  - It is red lit during the boot of the system. If it doesn't extinguish within some seconds, the unit needs servicing.

- B** **POWER LEDs:** indicate the status of the unit power supply: MAIN (main power supply) and BACKUP (redundant power supply).
 

Status:

  - Off: no mains input.
  - Green: power supply ON.

- C** **LAN LEDs:** indicate the status of the audio local area network: LAN 1 (main interface) and LAN 2 (secondary interface).
 

Status:

  - Off: no local network connection.
  - Blinking green: link is established at data level at 1Gbps.
  - Blinking yellow: link is established at data level at 100Mbps.
  - Blinking green and yellow: link is established at data level at 10Mbps.

If the boards are wired to a dedicated audio network using a switch, only LAN 1 should be blinking. If the wiring is connected in "Daisy Chain" mode, without switches, or there is a redundant network, both LEDs should be blinking.

**IMPORTANT NOTE:** When there is a redundant network, primary and secondary interfaces must be connected to separated networks.

- D** **On / Off switch.**

### 2.3.2. Description of the back panel and connections.

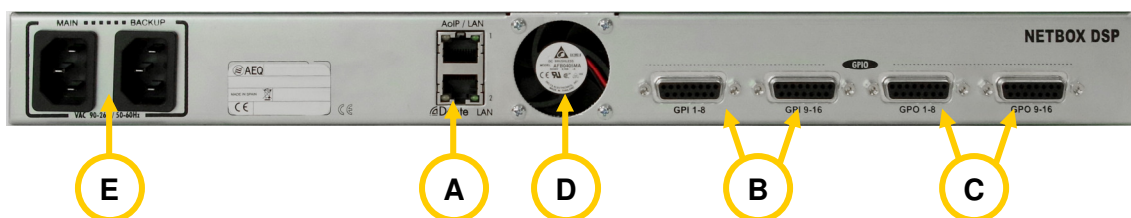

#### 2.3.2.1. Ethernet Ports (LAN 1 and LAN 2). **A**

NETBOX DSP includes two Ethernet ports: LAN 1 must always be wired, while LAN 2 is only used when the system is wired in "Daisy Chain" mode or a redundant system is set up.

**IMPORTANT NOTE:** When there is a redundant network, primary and secondary interfaces must be connected to separated networks.

These are the possible status of the signaling LEDs of the Ethernet connectors:

- Only yellow LED blinking: link established at 1Gbps.
- Only green LED blinking: link established at 100Mbps.
- Yellow and green LEDs blinking: link established at 10Mbps.

Physically, both are RJ45 10/100/1000, connectors, with the pinout described below:

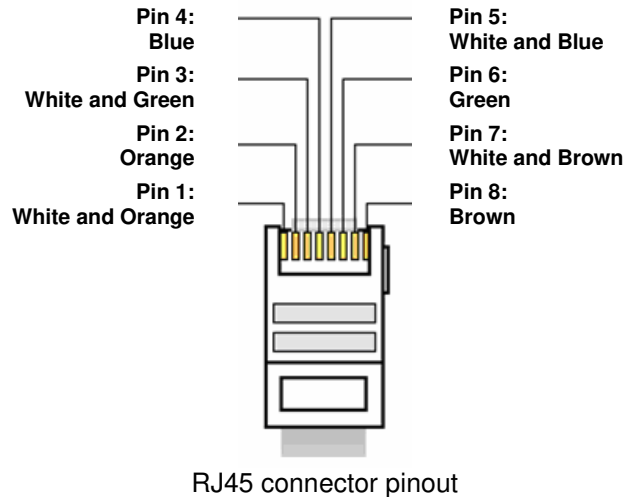

### 2.3.2.2. General Purpose Inputs (GPI). **B**

The physical connectors used are DB15-female, with the following pinout:

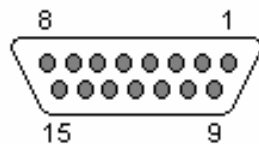

#### Pinout of DB15 GPI 1 - 8 connector

- Pin 1: GPI 1
- Pin 2: GPI 2
- Pin 3: GPI 3
- Pin 4: GPI 4
- Pin 5: GPI 5
- Pin 6: GPI 6
- Pin 7: GPI 7
- Pin 8: GPI 8
- Pin 9: GND\_GPI 1-4
- Pin 10: GND\_GPI 1-4
- Pin 11: GND\_GPI 1-4
- Pin 12: +5V GPIO
- Pin 13: GND\_GPI 5-8
- Pin 14: GND\_GPI 5-8
- Pin 15: GND\_GPI 5-8

Remarks: please note that a common ground (GND) is provided for inputs 1 to 4 and another one exists for inputs 5 to 8. Pin 12 supplies a +5V reference voltage to ease wiring.

#### Pinout of DB15 GPI 9 - 16 connector

- Pin 1: GPI 9
- Pin 2: GPI 10
- Pin 3: GPI 11
- Pin 4: GPI 12
- Pin 5: GPI 13
- Pin 6: GPI 14
- Pin 7: GPI 15
- Pin 8: GPI 16
- Pin 9: GND\_GPI 9-12
- Pin 10: GND\_GPI 9-12
- Pin 11: GND\_GPI 9-12
- Pin 12: +5V GPIO
- Pin 13: GND\_GPI 13-16
- Pin 14: GND\_GPI 13-16
- Pin 15: GND\_GPI 13-16

Remarks: please note that a common ground (GND) is provided for inputs 9 to 12 and another one exists for inputs 13 to 16. Pin 12 supplies a +5V reference voltage to ease wiring.

### 2.3.2.3. General Purpose Outputs (GPO). **C**

The physical connectors used are DB15-female, with the following pinout:

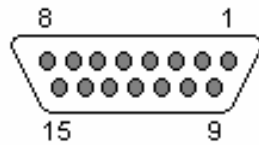

#### Pinout of DB15 GPO 1 - 8 connector

- |                |                       |
|----------------|-----------------------|
| - Pin 1: GPO 1 | - Pin 9: GND_GPO 1-4  |
| - Pin 2: GPO 2 | - Pin 10: GND_GPO 1-4 |
| - Pin 3: GPO 3 | - Pin 11: GND_GPO 1-4 |
| - Pin 4: GPO 4 | - Pin 12: +5V GPIO    |
| - Pin 5: GPO 5 | - Pin 13: GND_GPO 5-8 |
| - Pin 6: GPO 6 | - Pin 14: GND_GPO 5-8 |
| - Pin 7: GPO 7 | - Pin 15: GND_GPO 5-8 |
| - Pin 8: GPO 8 |                       |

Remarks: please note that a common ground (GND) is provided for inputs 1 to 4 and another one exists for inputs 5 to 8. Pin 12 supplies a +5V reference voltage to ease wiring.

#### Pinout of DB15 GPO 9 - 16 connector

- |                 |                         |
|-----------------|-------------------------|
| - Pin 1: GPO 9  | - Pin 9: GND_GPO 9-12   |
| - Pin 2: GPO 10 | - Pin 10: GND_GPO 9-12  |
| - Pin 3: GPO 11 | - Pin 11: GND_GPO 9-12  |
| - Pin 4: GPO 12 | - Pin 12: +5V GPIO      |
| - Pin 5: GPO 13 | - Pin 13: GND_GPO 13-16 |
| - Pin 6: GPO 14 | - Pin 14: GND_GPO 13-16 |
| - Pin 7: GPO 15 | - Pin 15: GND_GPO 13-16 |
| - Pin 8: GPO 16 |                         |

Remarks: please note that a common ground (GND) is provided for inputs 9 to 12 and another one exists for inputs 13 to 16. Pin 12 supplies a +5V reference voltage to ease wiring.

### 2.3.2.4. Cooling fan. **D**

The cooling fan doesn't need to operate in environments with "normal" temperature. The unit is cooled by natural convection, hence totally silent. When, for whatever reason, high operating temperature is reached, the low acoustic noise fan starts.

### 2.3.2.5. Power supply. **E**

The mains power supplies connectors (main and backup) are located in the back left area of the unit. Both internal power supplies are auto ranging, accepting: 90 - 132 V AC & 187 - 264 V AC, 47-63Hz.

### 2.3.2.6. Remarks on NETBOX DSP GPIOs wiring.

AEQ simplifies installation by providing the connection between the system and the connected devices. The "**CP CAB GPIO**" accessory is provided on-demand. It consists on a DB15 male connector soldered to a 15-way 6-meter long cable, with no connectors in the other end, for GPIs and GPOs. Each cable allows for the connection of the 8 GPIs or GPOs provided in each device's connector.



### 3. INSTALLATION AND USE OF APPLICATIONS.

#### 3.1. PC Applications for configuration and control.

In order to configure each NETBOX 8 AD, NETBOX 32 AD or NETBOX DSP and define interactions between them, consoles and other units through virtual GPIOs, "**AEQ NetBox Tool**" application must be used.



In order to control the system and select sources and destinations of audio signals processed on NETBOX 8 AD, NETBOX 32 AD and NETBOX DSP, "**Dante Controller**" application must be used. Please consult the **AEQ AoIP user's manual** for more information.



In order to access to routing and mixing of inputs to outputs of the system on NETBOX 8 AD MX Audio Router 16x16, NETBOX 32 AD MX Audio Router 64x64 and NETBOX DSP and to processing of inputs on NETBOX DSP, "**AEQ Netbox RTC**" application must be used. Please consult the **user's manual** of "**AEQ Netbox RTC**" application for more information.



#### 3.2. "AEQ NetBox Tool": control and configuration software for NETBOX 8, NETBOX 32 and NETBOX DSP.

##### 3.2.1. Introduction.

"**AEQ NetBox Tool**" application is the control and configuration software for NETBOX 8, NETBOX 32 and NETBOX DSP.

The auto run USB key furnished with those units contains the executable file that installs the application. Installing it is simply a matter of executing this file and following the on-screen instructions as they come up.

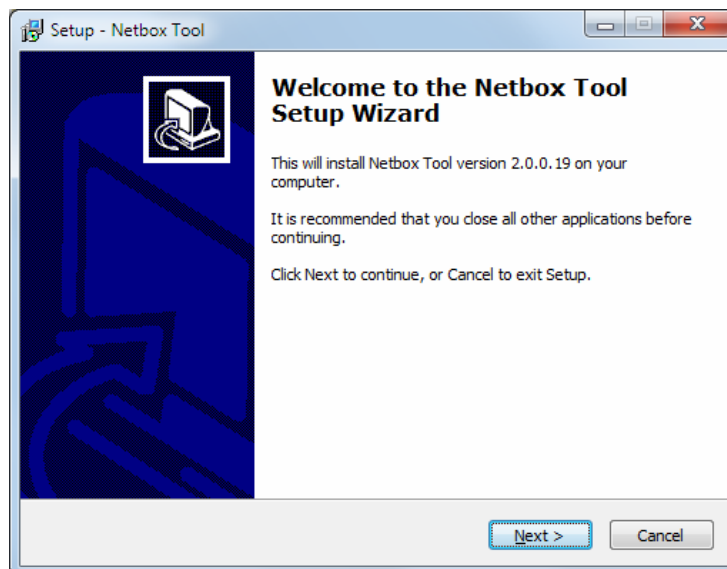

Once the "**AEQ NetBox Tool**" application is installed (by default, in C:\Program files\AEQ\Netbox), you can start it up by double-clicking the icon displayed on the desktop:



### 3.2.2. Administration Tools.

When the application starts up, the initial screen will appear allowing you to access the different options and showing the software version, as well as an image showing the equipment type (NETBOX 8, NETBOX 32 or NETBOX DSP) when connection is established.





On the left side of the screen all the relevant menus and submenus are available. These are drop-down menus and are activated by clicking on the desired option.

Depending on the connected equipment type (NETBOX 8, NETBOX 32 or NETBOX DSP) or the firmware versions of the unit (in the case of NETBOX 8 and NETBOX 32) different submenus will be available.

### 3.2.2.1. "Configurations" submenu.

"Configurations" submenu, accessed from the drop-down menu "Administration" by clicking on the corresponding icon, allows you to configure and control the communication between application and physical equipment. When no connection is established, this submenu looks like that:

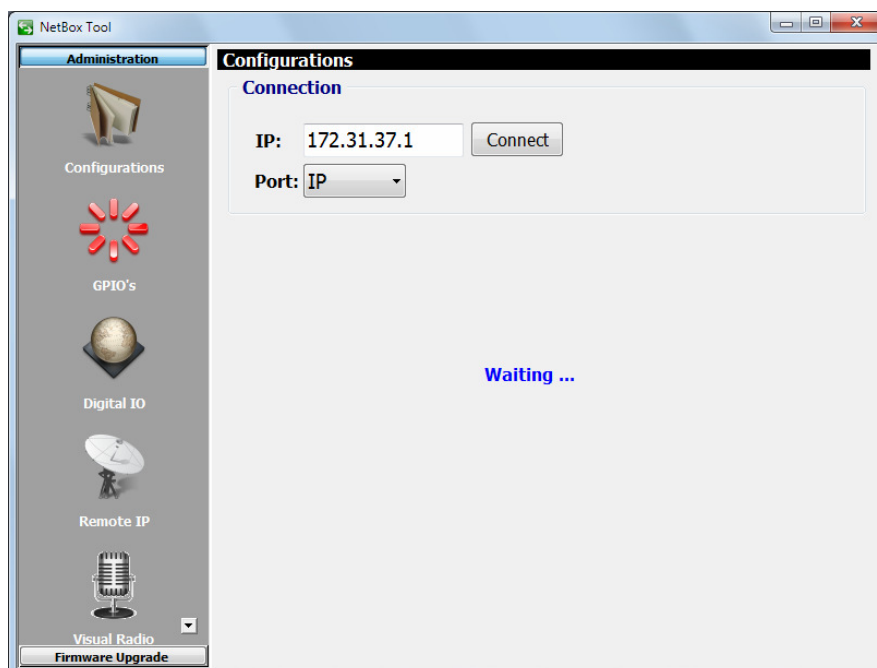

"**Connection**" section allows you to configure the parameters to connect to the unit. Firstly, the **IP** address of the equipment must be configured (by default, **NETBOX 32** units are supplied with **172.31.37.1** control IP address, **NETBOX 8** with **172.31.38.1** control IP address and **NETBOX DSP** with **172.31.50.1** control IP address) and the **Port** the connection will be established through (**IP**). Where there is more than one unit with the same IP in the same network, you should connect to each one of them individually and change their address in order to avoid network conflicts.

In order to connect to the unit by means of "AEQ NetBox Tool" application, **either of the two Ethernet ports** can be used, as both share the same control IP address. There are **2 exceptions** to this rule (see section 4.8.3.6 of the AEQ AoIP user's manual):

- In case that the unit is configure in "**Redundant-control-only-primary**" mode by means of "Dante Controller" application (available mode for AoIP firmware version 4.0.4.22 or higher) **LAN 1** should be used in order to establish connection by means of "AEQ NetBox Tool": this mode configures the device as redundant at Dante level but the control of the unit at local level can be accomplished only through upper Ethernet port.
- In case that the unit is configure in "**Primary&Control**" mode by means of "Dante Controller" application (available mode for AoIP firmware version 4.0.9.2 or higher) **LAN 2** should be used in order to establish connection by means of "AEQ NetBox Tool": this mode separates Dante primary network (accessed only through upper Ethernet port) and local control network (accessed only through lower Ethernet port).

**IMPORTANT NOTE:** In case you don't know the IP address of the unit, there is a **procedure** (included in the "Extras" menu of the USB key furnished with the unit) that allows you to return to default configuration in order to control the unit again.

**NOTE:** The "**Port**" drop-down menu allows you to select that connection would be established through a serial port, but only for maintenance purposes and under AEQ Technical Service supervision (support@aeq.es).

When the unit is correctly detected, the configuration buttons will appear activated (the "Connect" button allows you to force the connection, although where there is communication with the unit that connection is established automatically).

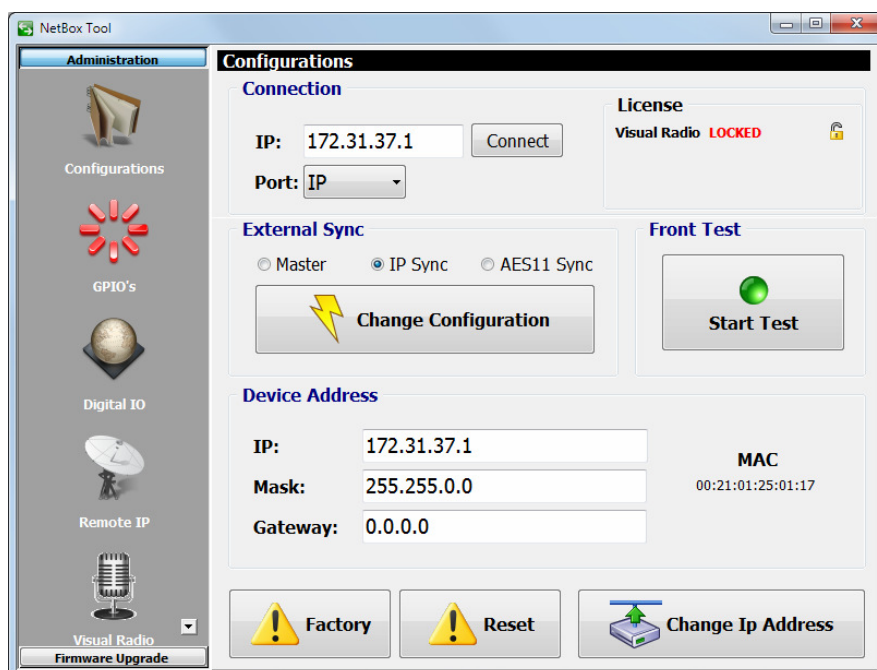

"License" section (that appears only for CPU version 1.32 or higher) allows you to activate the following functionalities:

- **"Visual Radio"**, that allows you to send vumeters of any of the inputs of the unit to different IP addresses, turning the unit into a multichannel level detector for camera selection in Visual Radio systems ("NETBOX 8 AD VX" or "NETBOX 32 AD VX"). See section 3.2.2.5 of this manual. This option and the associated submenu appear only for NETBOX 8 and NETBOX 32 with CPU version 1.xx or 3.xx (lower than 3.51).
- **"Netbox RTC"**, that allows you to turn the NETBOX 8 or NETBOX 32 unit into a mixing and distributing audio matrix ("NETBOX 8 AD MX Audio Router 16x16" or "NETBOX 32 AD MX Audio Router 64x64") and to control these units and the NETBOX DSP by means of "AEQ Netbox RTC" application (see the user's manual of that application). This option appears only for NETBOX 8 and NETBOX 32 with CPU version 2.xx or higher than 3.50 and for NETBOX DSP with any CPU version. The IP address of the Netbox server is also shown.

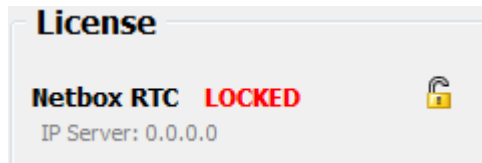
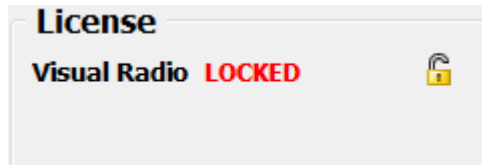

In order to activate any of this 2 options, you must purchase a user **license**.

When you press the padlock associated to any of the 2 options, a window will appear allowing you to introduce the key that activates the corresponding functionality.

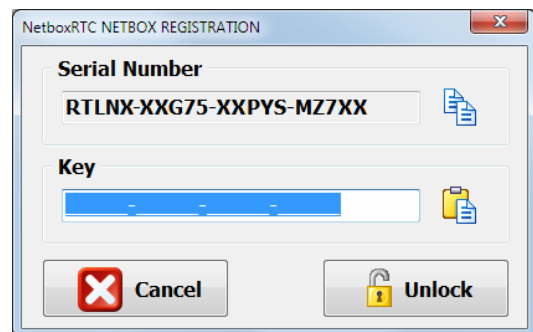
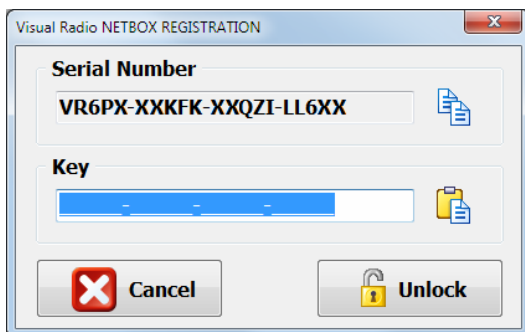

In case your order includes any of those functionalities, the unit is supplied from Factory activated. If you want to activate it a posteriori, you must copy the "Serial Number" by means of the associated button and send it to AEQ in order to generate the associated "Key" and send it back to you (you must paste it by means of the associated button).



The **"Unlock"** button allows you to confirm the key and, when it's correct, activate the functionality.

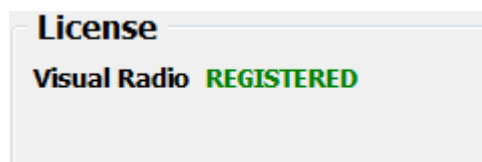
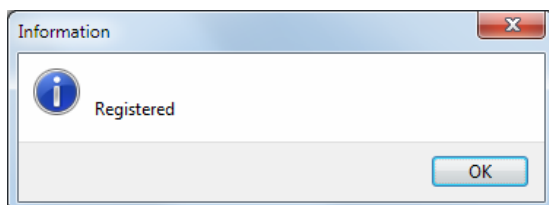

**IMPORTANT:** Once any of the 2 functionalities is activated, you must execute a **"Factory"** to the unit by means of the button that appears at the bottom of the submenu, taking into account that it will return to initial Factory parameters (including the control IP address).

In case the key is not the right one, a warning message will appear:

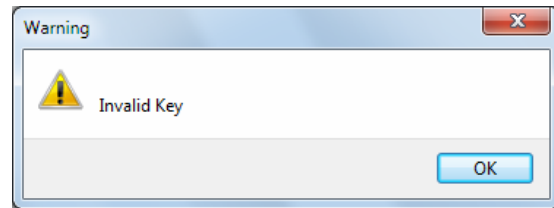

"**External Sync**" section allows you to configure the synchronization mode: whether the unit works as "**Master**" (only one unit per network must be configured that way) or it's synchronized through IP connection ("**IP Sync**") or through the source connected to **digital input 1** ("**AES11 Sync**"). The selected option will be applied when pressing "**Change Configuration**" button. Confirmation is requested. In the case of **NETBOX DSP** the third option is not available.

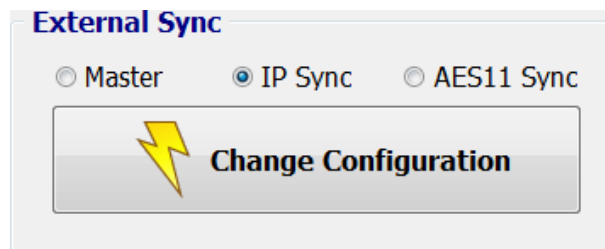

"**Front Test**" section allows you to start a test of front level indicators, by pressing the "**Start Test**" button (when test is started, the button changes to "**Stop Test**" and allows you to stop the process). The front LEDs will light one by one following the green-red-yellow sequence. In the case of **NETBOX DSP** this section is not shown because there are no frontal level indicators.

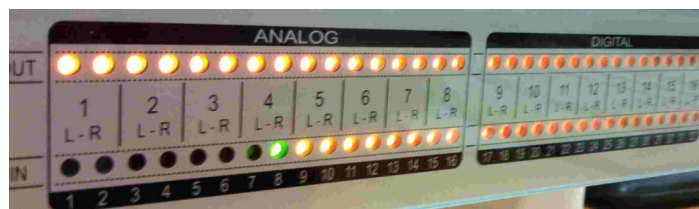
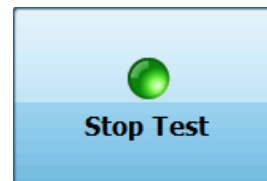
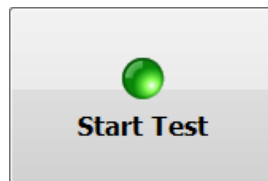

"**Device Address**" section allows you to configure the control IP parameters of the Ethernet interface of the unit:

- "**IP**": valid control IP address associated with the interface.
- "**Mask**": valid subnet mask associated with the interface.
- "**Gateway**": valid gateway or network gateway address associated with the interface.
- "**MAC**": valid MAC address associated with the interface (this parameter is automatically configured depending on the IP address assigned to the unit).

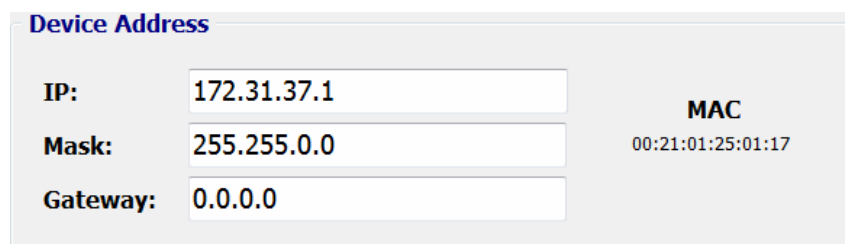

Once these parameters are configured, the changes will be applied by pressing "**Change Ip Address**" button. Confirmation is requested.

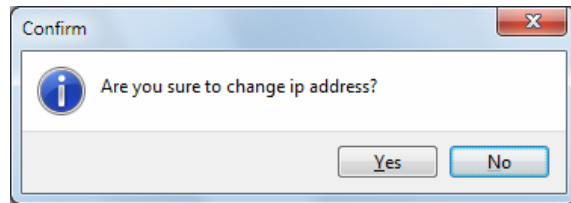
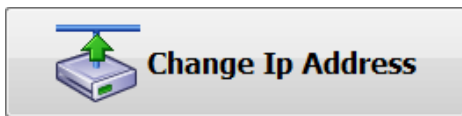

The "**Factory**" button allows you to return to initial Factory parameters.



The "**Reset**" button allows you to restart the unit.

Confirmation is requested for both options.



### 3.2.2.2. "GPIO's" submenu.

"**GPIO's**" submenu, accessed from the drop-down menu "Administration" by clicking on the corresponding icon, allows you to check the functioning and perform basic operations of unit's physical GPIO's (the GPIO's are normally used in relation with other units and applications).

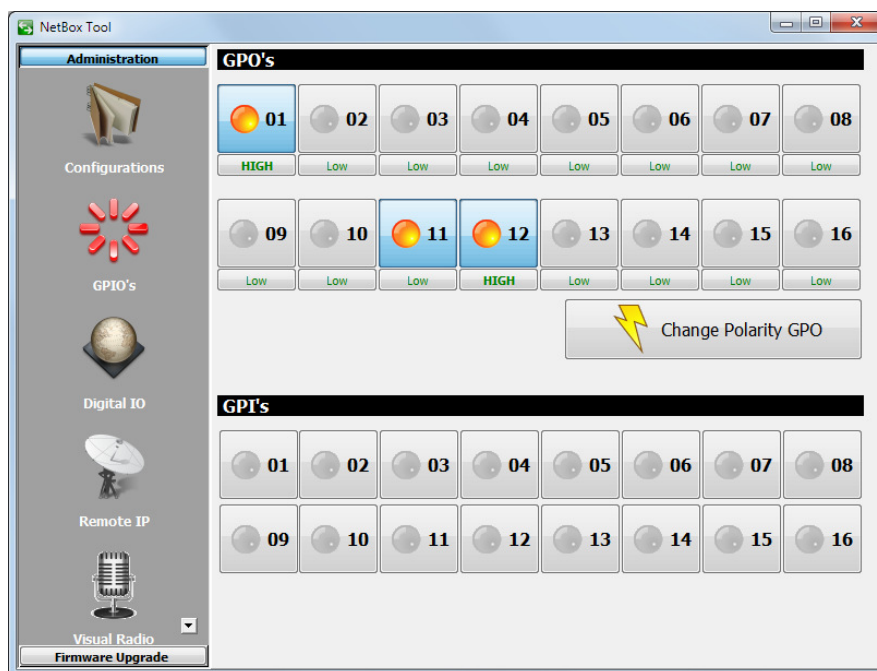

When you press any of the 16 numbered buttons in "**GPO's**" section (in the case of **NETBOX 32** and **NETBOX DSP**) it is lighted in amber and the corresponding GPO of the unit changes to active status:

- In case that GPO is configured as "**HIGH**", the circuit between the corresponding pin and the ground pin in DB15 connector of the unit gets open.
- In case that GPO is configured as "**Low**", the circuit between the corresponding pin and the ground pin in DB15 connector of the unit gets closed.

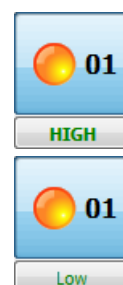

In order to change the default configuration of a GPO closing and opening you must press the associated button, that will change from "HIGH" to "Low" or vice versa, although changes will not be applied until you press the "**Change Polarity GPO**" button. Confirmation is requested.

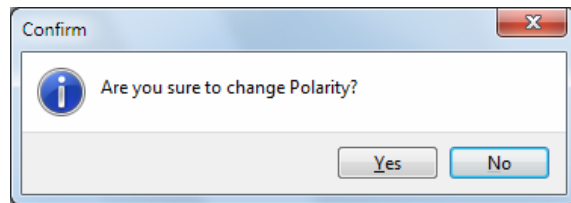
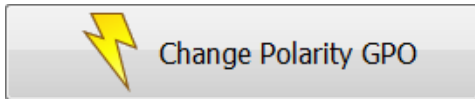

In the case of **NETBOX 8** there are only **4 GPI's** and **4 GPO's** available, so that only 4 numbered buttons are shown in each section:

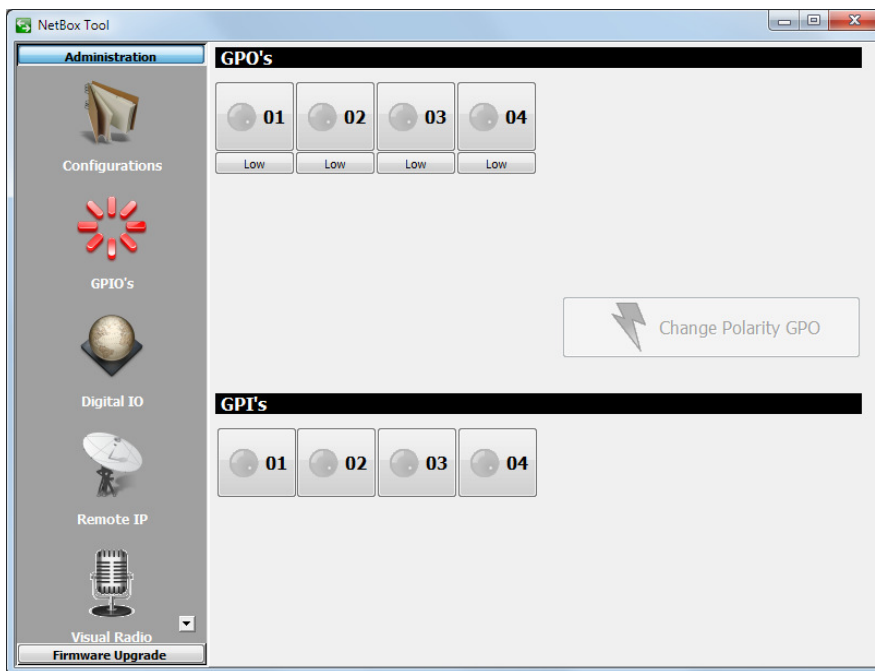

The voltage and current limits for external power supply of GPO are 200 volts and 120mA.

The unit provides a +5V voltage in order to make easier GPO's cabling when the receiver unit accepts logical levels and needs low charge levels. In order to use the voltage provided by the unit, you have to connect the floating ground of GND pin to the connector chassis. A device with a consumption lower than 3mA can be connected between GPO pin and the one with +5V voltage.

When a **GPI** is activated in the unit (**GPI's** are active at **high level**), the corresponding button in "**GPI's**" section will light in amber. This GPI will be also transmitted through the network to all the IP addresses configured in "**Remote IP**" submenu (see section 7.2.4 of this manual). In order to activate a GPI with internal voltage, you have to connect the floating ground to the connector chassis.

### 3.2.2.3. "DIGITAL IO" submenu.

"**DIGITAL**" submenu, accessed from the drop-down menu "Administration" by clicking on the corresponding icon, gives access to an information window where you can check the digital inputs and outputs format. These inputs and outputs are configured as AES/EBU by default and can be configured as SPDIF by changing some internal jumpers.

In the case of **NETBOX 32** there are **8 digital inputs** and **8 digital outputs**.

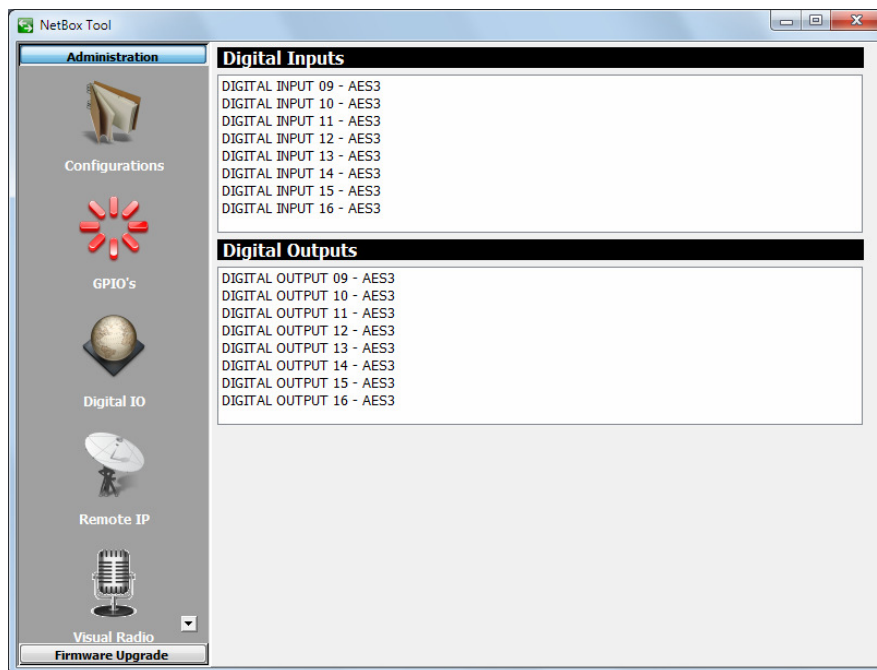

In the case of **NETBOX 8** there are **2 digital inputs** and **2 digital outputs**, and besides the second input/output can be configured by means of a switch in order to be available in DB15 connector or in USB connector and that configuration is also shown in this submenu:

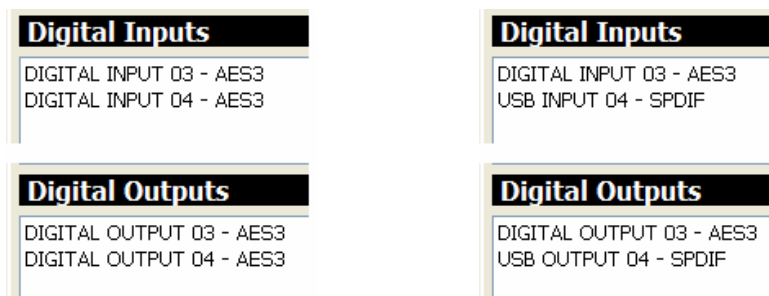

In the case of **NETBOX DSP** this submenu is not shown because there are no digital inputs and outputs.

### 3.2.2.4. "Remote IP" submenu.

"Remote IP" submenu, accessed from the drop-down menu "Administration" by clicking on the corresponding icon, allows you to manage the virtual GPI's and GPO's, as well as their association to the local physical general purpose inputs and outputs (Physical GPI/Os).

The **connection port** is a fixed parameter (**2001**) and it's shown only for informative purposes.

#### "Physical GPI - Virtual GPO association":

This section allows you to distribute remotely the physical GPI's status of a NETBOX unit in order to activate the GPO's (or generate other actions) of another NETBOX unit or other AEQ IP units as Forum, Capitol, Phoenix audiocodexs, Systel IP and Audio+. The parameters of a virtual GPO are the control **IP address** of the unit that will receive it and an **"Id"** number (identifying number from 0 to 255) that must be the same in transmission and reception units.

### "Physical GPO - Virtual GPI association":

This section allows you to control from another NETBOX unit or other AEQ IP unit as Forum, Capitol, Phoenix audiocodecs, Systel IP and Audio+, the status of each one of the NETBOX unit physical GPO's. The parameters of a virtual GPI are the control **IP address** of the unit the GPI will be received from and an **"Id"** number (identifying number from 0 to 255) that must be the same in transmission and reception units.

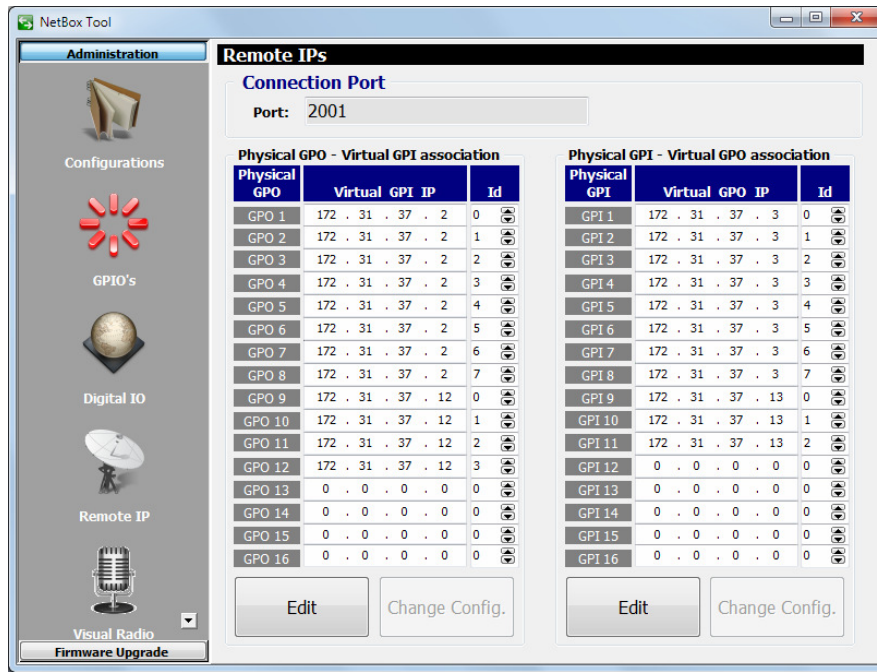

The upper image shows an example where our NETBOX 32 unit's IP address is supposed to be 172.31.37.1.

The control of virtual GPI's from 1 to 8 is received from a unit with IP address 172.31.37.2, the "Id" numbers used in this match-up are the ones from 0 to 7, and the local physical GPO's from 1 to 8 will be activated. The control of virtual GPI's from 9 to 12 (that will activated physical GPO's from 9 to 12) is received from a unit with IP address 172.31.37.12, and the "Id" numbers used in this match-up are the ones from 0 to 3.

On the other hand, the virtual GPO's from 1 to 8 (corresponding to the status of physical GPI's with the same numbers) are sent to a unit with IP address 172.31.37.3, and the "Id" numbers used in this match-up are the ones from 0 to 7. The virtual GPO's from 9 to 11 (corresponding to the status of physical GPI's with the same numbers) are sent to a unit with IP address 172.31.37.13, and the "Id" numbers used in this match-up are the ones from 0 to 2.

In order to configure virtual GPI's or GPO's you must press the associated **"Edit"** button (the headline of the corresponding section changes from blue to green), make the desired configuration and apply the changes by pressing the **"Change Config."** button. If you want to cancel the changes before pressing "Change Config.", you can do it by pressing the "Cancel" button.



### 3.2.2.5. "Visual Radio" submenu.

"Visual Radio" submenu, accessed from the drop-down menu "Administration" by clicking on the corresponding icon, allows you to configure the IP addresses where you want to send vumeters of any of the inputs of the unit (those IP addresses must be in the same control subnet). In order to use this functionality, you must purchase a user **license** (see section 3.2.2.1 of this manual).

This submenu appears only for **NETBOX 8** and **NETBOX 32** with CPU version 1.xx or 3.xx (lower than 3.51). In the case of **NETBOX DSP** this submenu is not shown.

In the case of **NETBOX 32** there are **2 tabs** that allows you to configure where to send vumeters of the analog and/or digital inputs of the unit ("ANALOG / AES" tab) and/or vumeters of the AoIP Dante inputs ("AOIP Dante" tab).

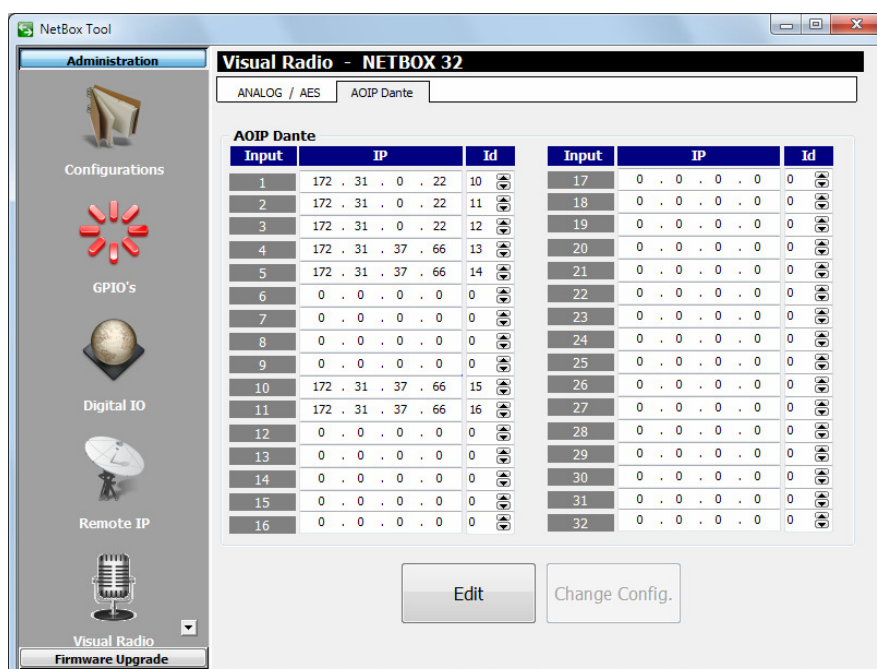
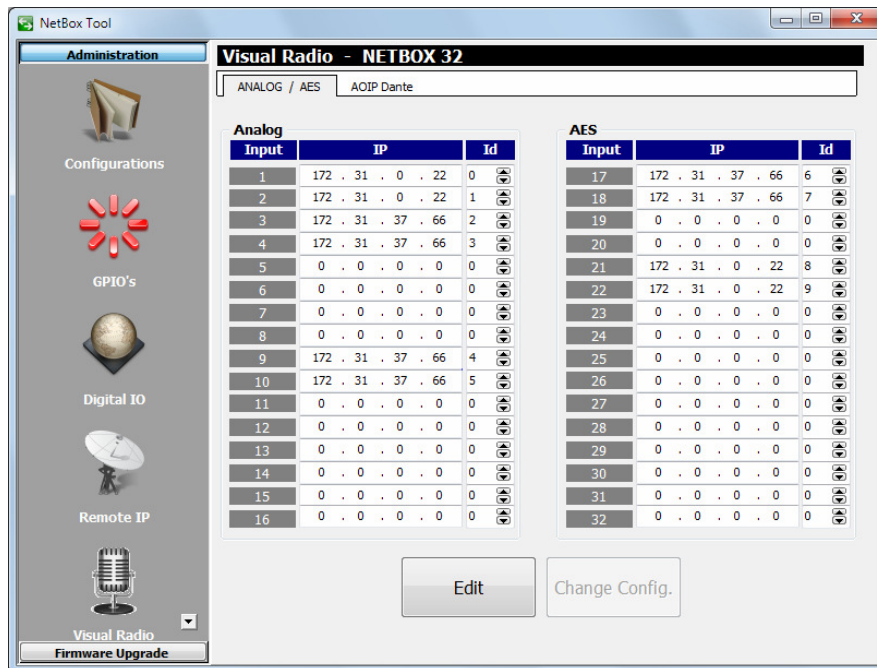

The previous images show an example where vumeters of the first 2 analog inputs, the fifth and sixth digital inputs and the first 3 AoIP Dante inputs are sent to IP address 172.31.0.22, with "Id" numbers 0, 1, 8, 9, 10, 11 and 12 respectively.

On the other hand, vumeters of the third, fourth, ninth and tenth analog inputs, the first 2 digital inputs and the fourth, fifth, tenth and eleventh AoIP Dante inputs are sent to IP address 172.31.37.66 with "Id" numbers 2, 3, 4, 5, 6, 7, 13, 14, 15 and 16 respectively.

In the case of **NETBOX 8** there is only one configuration section in order to indicate where to send vumeters of the analog, digital and/or AoIP Dante inputs of the unit.

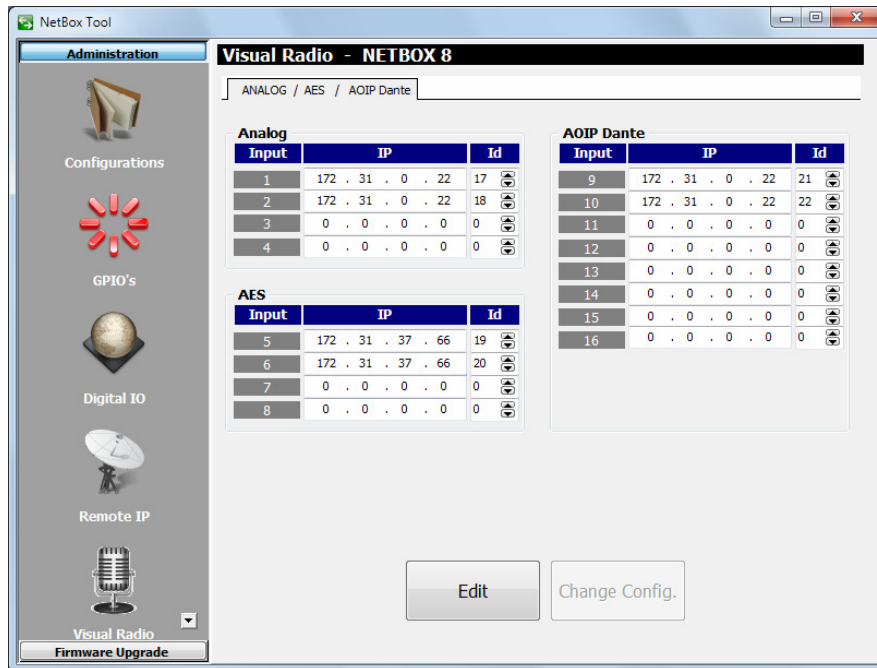

The previous image shows an example where vumeters of the first 2 analog inputs and the first 2 AoIP Dante inputs are sent to IP address 172.31.0.22, with "Id" numbers 17, 18, 21 and 22 respectively. On the other hand, vumeters of the first 2 digital inputs are sent to IP address 172.31.37.66 with "Id" numbers 19 and 20 respectively.

In order to configure this section you must press the associated **"Edit"** button (the headline of the corresponding section changes from blue to green), make the desired configuration and apply the changes by pressing the **"Change Config."** button: then the unit will reset. If you want to cancel the changes before pressing "Change Config.", you can do it by pressing the "Cancel" button.

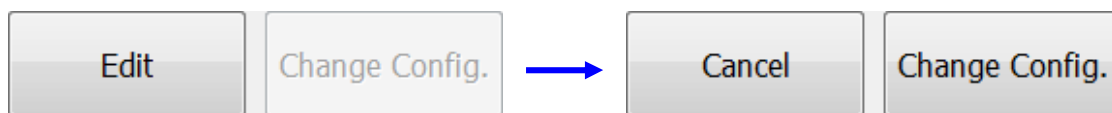

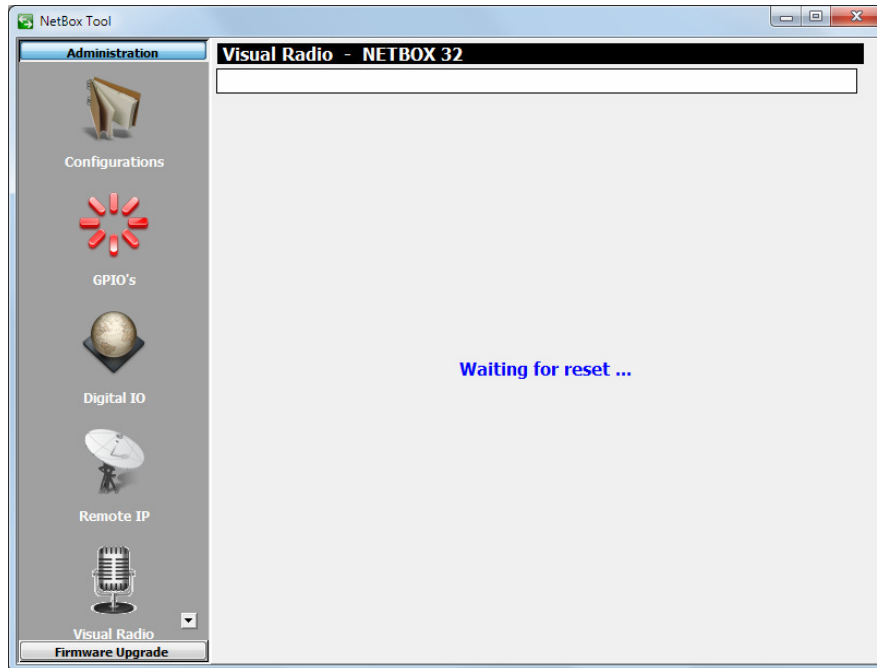

### 3.2.2.6. "Gains" submenu.

"Gains" submenu, accessed from the drop-down menu "Administration" by clicking on the corresponding icon, allows you to configure the input and output gains of each one of the analog and digital audio connections, adjusting inputs to the most proper level for transmission through DANTE network and outputs to the necessary level for destination unit reception.

This submenu appears only for **NETBOX 8** and **NETBOX 32** with CPU versions 1.xx or 3.xx (lower than 3.51).

In the case of **NETBOX DSP** this submenu is not shown.

In the case of **NETBOX 32** there are **8 analogue inputs/outputs** and **8 digital inputs/outputs**.

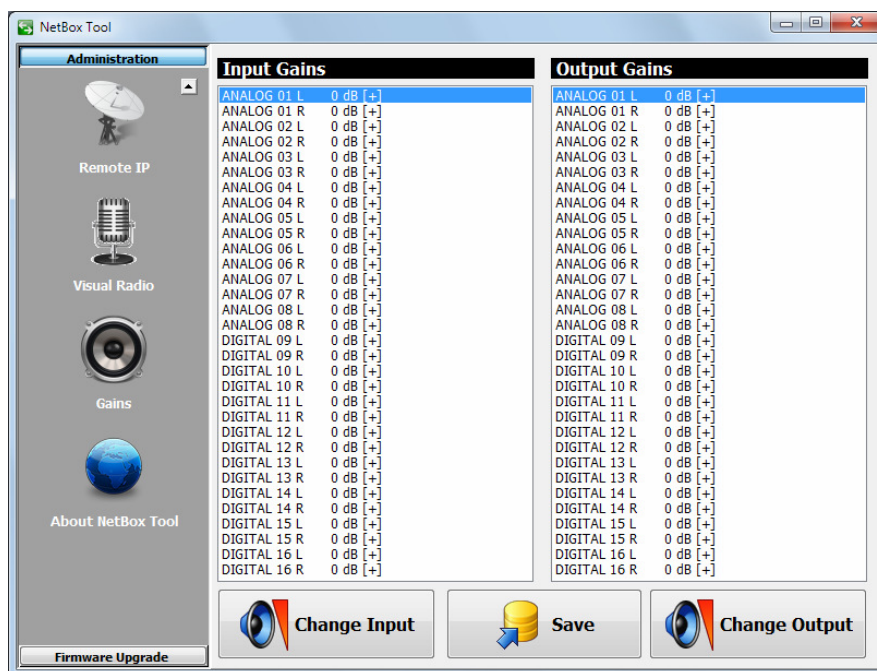

In the case of **NETBOX 8** there are **2 analogue inputs/outputs** and **2 digital inputs/outputs** (the second one can be switched between DB15 connector and USB connector):

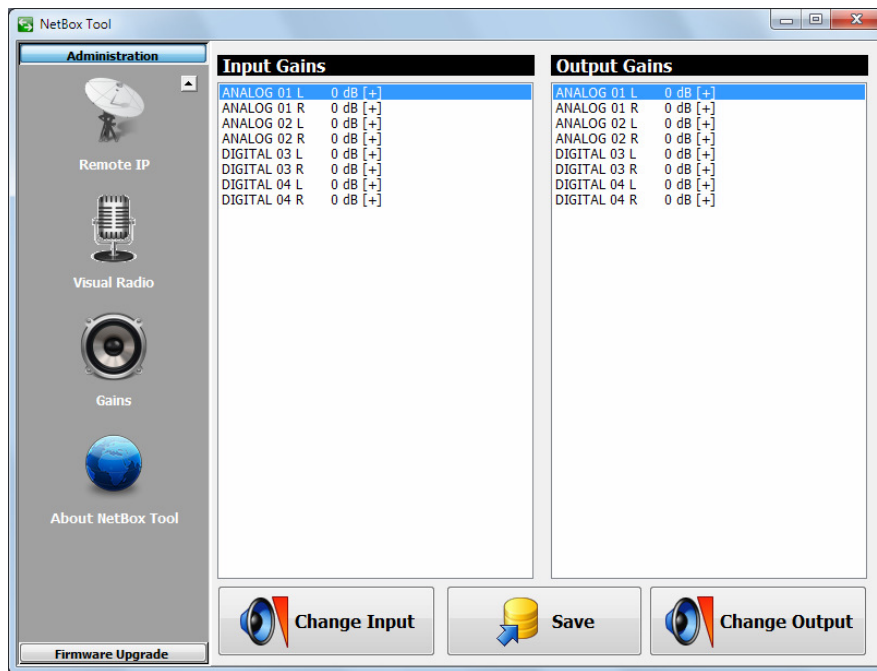

When you select one of the inputs or outputs of the list and double-click on it (or press the "Change Input" or "Change Output" button), a window will appear allowing you to configure that input or output gain.

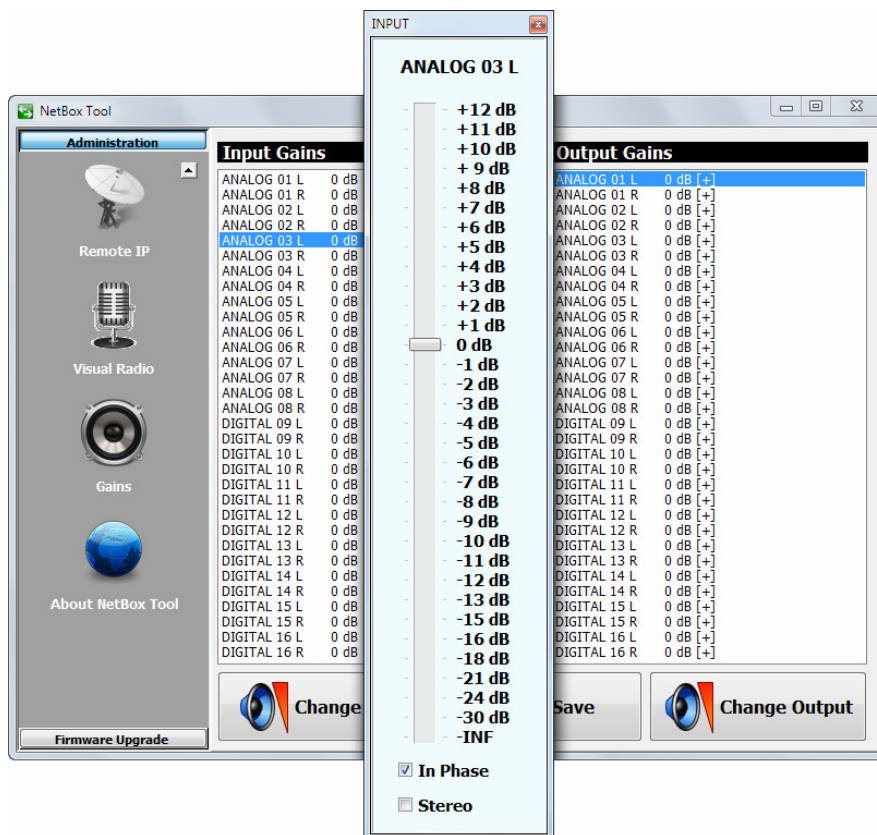

The **"In Phase"** checkbox allows you to modify the input or output signal phase (the sign on the right part of the line corresponding to the selected input or output changes from + to – or vice versa):

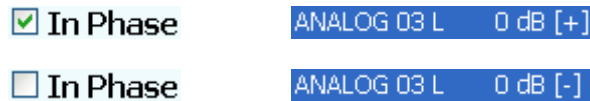

The **"Stereo"** checkbox allows you apply the gain changes, as well as the phase changes, to stereo pair. It must be activated before modify those parameters, in order to apply them simultaneously to L and R channels of selected input or output.



The **"Save"** button allows you to save the changes in the non volatile memory of the unit (that way those changes will remain saved although the unit is turned off).

### 3.2.2.7. "About NetBox Tool" submenu.

**"About NetBox Tool"** submenu, accessed from the drop-down menu "Administration" by clicking on the corresponding icon, shows the version and date of "AEQ NetBox Tool application". It also shows an image of the equipment type (NETBOX 8, NETBOX 32 or NETBOX DSP) when connection is established.





### 3.2.3. Upgrading Tools.

"Firmware Upgrade" menu is a maintenance menu that allows you to update the firmware versions of the unit.

**IMPORTANT NOTE:** Any operation in this "Firmware Upgrade" section should only be accomplished by qualified personnel in possession of all necessary technical information relative to this system and with the possibility to establish a direct communication with AEQ Technical Service (support@aeq.es).

In order to execute this menu available options, it is necessary to be in direct communication with the NETBOX 8, NETBOX 32 or NETBOX DSP unit, through its Ethernet port. In case there is no connection to unit, the associated submenus will be shown blank.

"Tree View" submenu, accessed from the drop-down menu "Administration" by clicking on the corresponding icon, provides a global view of the system, with a tree structured diagram, providing information regarding the currently installed firmware versions for each of the modules of the unit. The equipment type (NETBOX 8, NETBOX 32 or NETBOX DSP) is also shown.

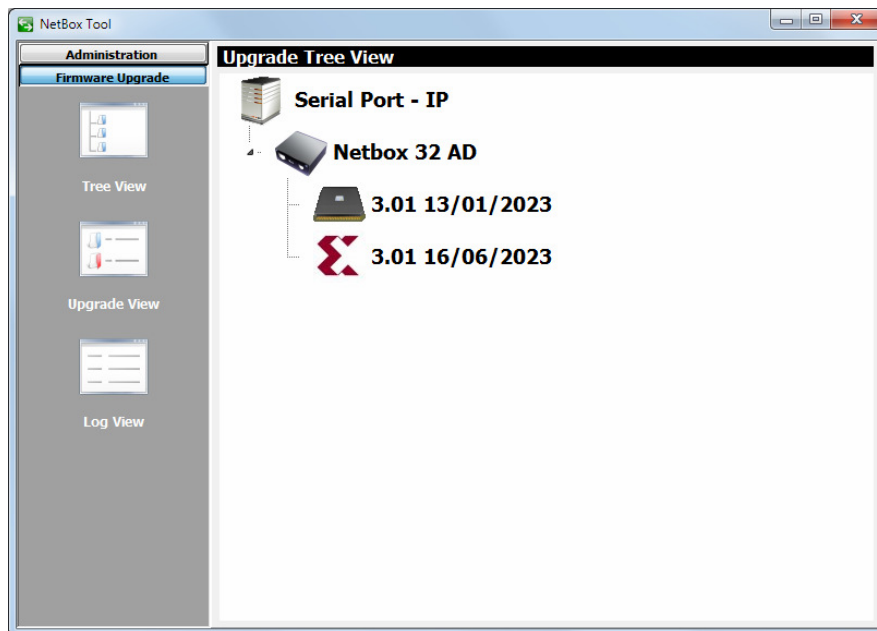

The following icon represents unit's **micro** or **CPU** 

The following icon represents unit's **FPGA** 

In the case of **NETBOX DSP**, there is a third functional module, **DSP**, with the following 

Finally, **AoIP** module firmware must be upgraded by means of "**DANTE Firmware Update Manager**" application. Please consult the **AEQ AoIP user's manual** for more information.

**IMPORTANT NOTE:** In the case of **NETBOX 32** there are 2 models of the **FPGA** module chip: **LX9** and **LX16**. Each model has associated **exclusive** firmware versions for both the **CPU** module and the **FPGA** module. If you have any doubt, consult AEQ Technical Service.

In order to upgrade the unit's firmware, place the pointer on its name, press the right mouse button and then the "Upgrade" option that appears

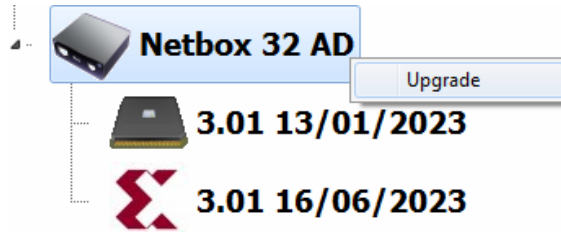

In the new window that appears, press the  button and select the "AFU" upgrading file (AEQ Firmware Upgrade) that contains the new version you want to load.

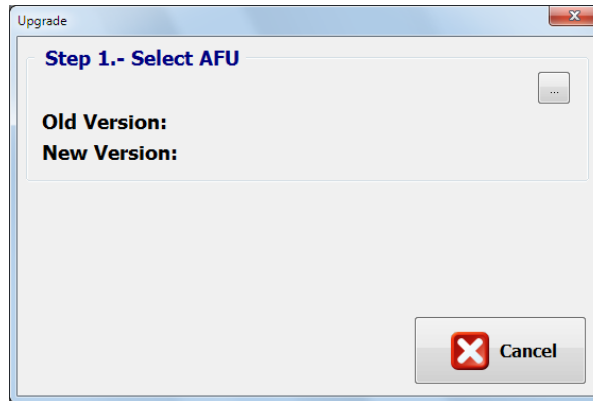

Once it's selected, the following window shows the old and new versions of the module to be upgraded and allows you to start the upgrading process by pressing the "Upgrade" button.

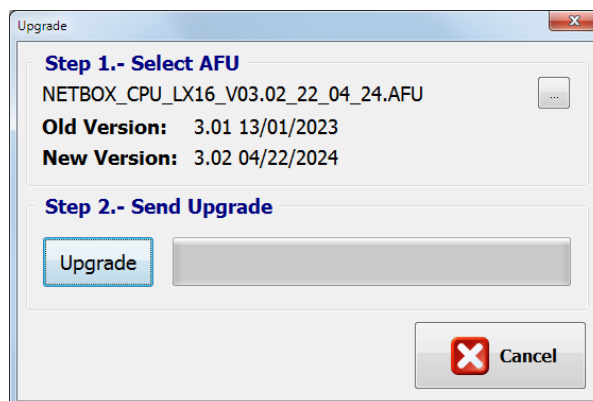

From this point on, the application changes automatically to "Upgrade View" screen in order to show you the upgrading progress:

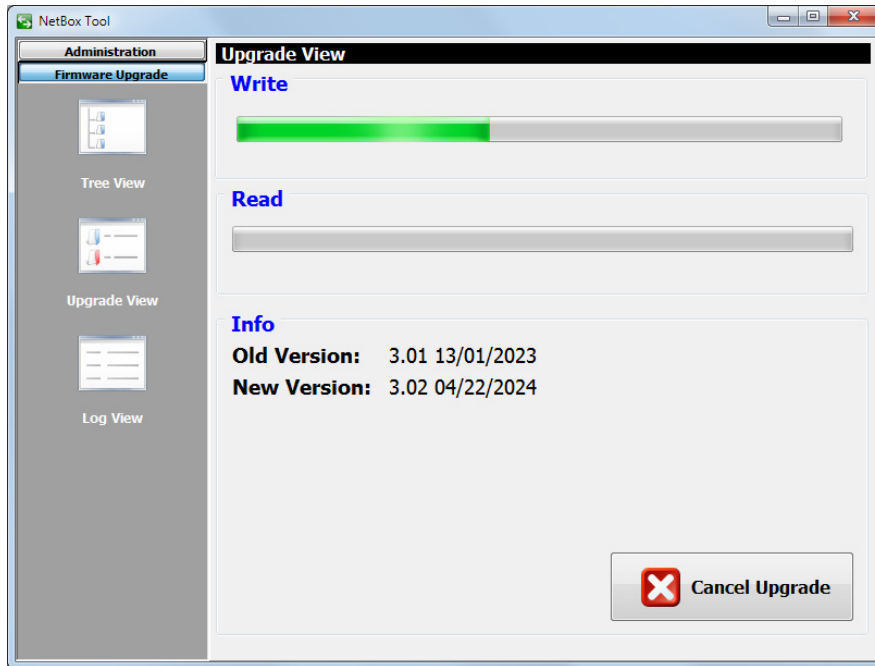

The following fields are visible on screen:

- **"Write"**: progress bar concerning the AFU file copy process from the computer that is running application to the unit internal memory
- **"Read"**: progress bar concerning the AFU file reading process. Usually unseen due to its rapidity.
- **"Info"**: **while upgrading is in progress** it shows information regarding old and new versions of the module to be upgraded.

**IMPORTANT NOTE:** You should not act on the system and you must never turn off the equipment during the upgrading process, since this action may deprogram the module that you are trying to upgrade. There is no pre-established upgrading order.

As previously indicated, in the case of **NETBOX 32** there are 2 models of the **FPGA** module chip: **LX9** and **LX16**. Each model has associated **exclusive** firmware versions for **CPU** and **FPGA** modules. In case you select an AFU file that does not correspond to the installed FPGA model, an error message will be displayed:

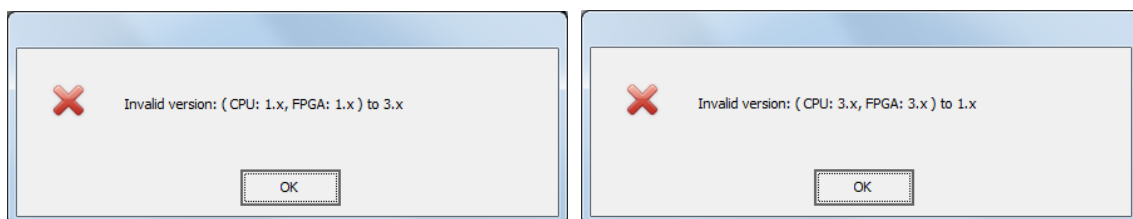

The first example corresponds to a device with LX9 FPGA to which we try to load the firmware associated to LX16 and the second one corresponds to the opposite case.

In addition, in any of these cases, the "Upgrade" button will not appear on the screen that allows you to start the upgrading process and you will have to press the  button again to select an AFU file that corresponds to the installed FPGA model:

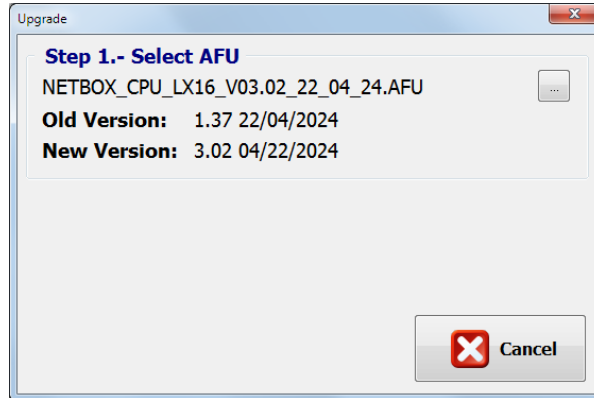

"Log View" submenu, accessed from the drop-down menu "Administration" by clicking on the corresponding icon, represents the record containing all the actions associated with a particular upgrade process as a sequence of independent events chronologically ordered and allows you to check whether the process ended correctly or not. This submenu provides complementary information to "Tree View" and "Upgrade View" submenus.

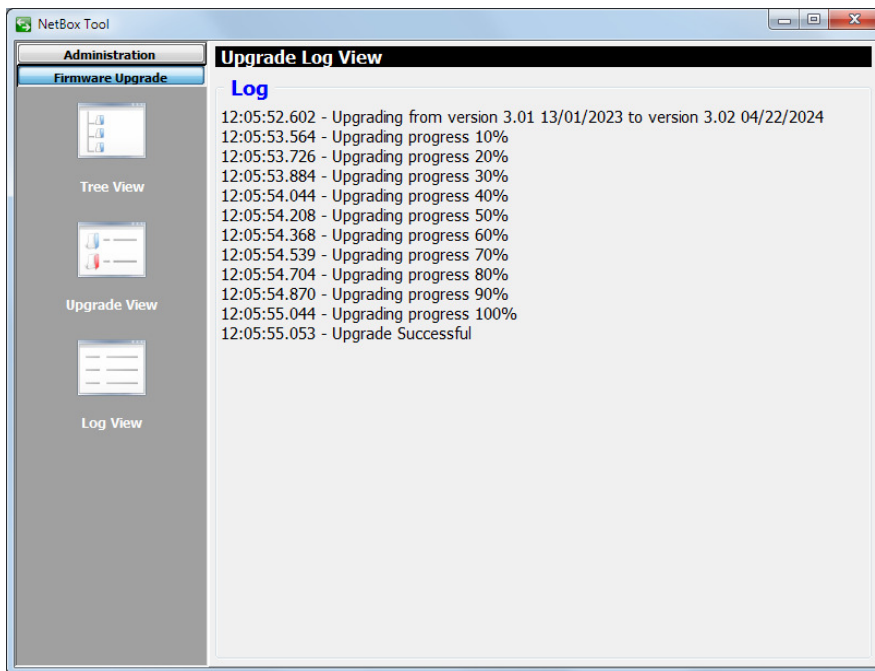

#### 4. TECHNICAL SPECIFICATIONS.

- Channels: 8 bidirectional (NETBOX 8) / 32 bidirectional (NETBOX 32) / 64 bidirectional (NETBOX DSP 64) / 96 bidirectional (NETBOX DSP 96) / 128 bidirectional (NETBOX DSP 128) / 160 bidirectional (NETBOX DSP 160).
- Internal sampling rate 48 kHz to 24 bits. Variable through external clock reference.
- Data format: DANTE Audio-over-IP technology.
- AVB - ready.
- Plug-and-play technology - automatic detection of the hardware and simple audio routing.
- Precise sample-level synchronization, even through several switches.
- Very low and deterministic delay in the entire network.
- Flexible and scalable network topology, supporting a great number of audio transmitters and receivers.
- Works in 100 Mbps, 1 Gbps and 10 Gbps networks.
- Supports a single integrated network used for audio, video, control and monitoring. Compatible with other kinds of traffic using QoS management.
- Uses low-cost, off the shelf network infrastructure.
- 24-bit, 48 KHz. audio resolution.
- Delay: 1-1.5 ms (@ 48 KHz typical, depending on network performance and complexity).
- 2 RJ45 Ethernet ports per interface, 1000 BASE-T, galvanically isolated, that can be used for redundancy or daisy-chain connections.
- Binary rate: 10/100/1000 Mbps.
- Maximum segment length: 100m max. over CAT5e or better cabling.

#### Software specifications.

"AEQ NetBox Tool" application on Windows operative system with the following functions:

- IP configuration, synchronization and input/output gains.
- GPIOs configuration, selection of the network devices receiving its GPIs and pairing of physical and virtual GPIOs.
- IP addresses configuration to send the vumeters for any of the device inputs, in order to link to Visual Radio systems.

"Dante Controller" application on Windows operative system with the following functions:

- View all Dante-enabled audio devices and their channels on the network.
- View Dante-enabled device clock and network settings.
- Route audio on these devices, and view the state of existing audio routes.
- Lock and unlock Dante devices.
- Change the labels of audio channels.
- Customize the receive latency (latency before play out).
- Save audio routing presets.
- Apply previously saved presets.
- View and set per device configuration options including:
  - Changing the device name.
  - Changing sample rate and clock settings.
  - Viewing detailed network information.
  - Access the device web page to upgrade firmware and license information (where supported).
  - Identify a device for example by flashing LEDs (where supported).
- View network status information, including:
  - Multicast bandwidth across the network.
  - Transmit and receive bandwidth for each device.
- View device performance information, including latency statistics and packet errors.

- View clock status information for each device, including frequency offset history and clock event logs.

"AEQ Netbox RTC" application on Windows operative system with the following functions:

- Routing with audio mixing and distribution coming from mono or stereo analogue, digital and Dante inputs, delivering them to analogue, digital or Dante outputs.
- Inputs and output processing and vumeters and test tone generation (only for NETBOX DSP).
- Configuration and scheduling salvo and macro management.
- Multi-user and multi-device control. Different views and particular scenarios can be configured, and critical lines can be protected.

### **General specifications.**

- Dimensions and weight:
  - NETBOX 32 AD: 44 x 482 x 361 mm (1.73" x 18.97" x 14.21"). 4,5 Kg. (9.92 lbs).
  - NETBOX 8 AD: 44 x 211 x 300 mm (1.73" x 8.30" x 11.81"). 1,8 Kg. (3.96 lbs).
  - NETBOX DSP: 44 x 482 x 275 mm (1.73" x 18.97" x 10.82"). 3,5 Kg. (7.7 lbs).
- Power supply:
  - NETBOX 32 AD: Universal auto-range internal power supply: 90 - 132 V AC & 187 - 264 V AC, 47-63Hz. Optionally, a second (backup) power supply can be installed in order to have redundancy.
  - NETBOX 8 AD: External 48V DC adapter. The provided universal mains adapter operates from 90 to 264 V AC, 47-63Hz.
  - NETBOX DSP: Double universal auto-range internal power supply: 90 - 132 V AC & 187 - 264 V AC, 47-63Hz. In case that one of them stops receiving mains or fails, the system is fed by the other one without any operation disruption.
- Ventilation. Noiseless natural convection. Suitable for self-operation. In the case of NETBOX DSP there is low acoustic noise fan that starts only when high operation temperature is reached.
- Audio line outputs compatible with "FR CAB INP" wiring accessory.
- General GPIs and GPOs compatible with "CP CAB GPIO" wiring accessory.
- Analog inputs:
  - Nominal level: +4dBu.
  - Maximum level:  $\geq +24$ dBu.
  - Bandwidth: 20Hz-20Khz @ +4dBu, +/-0.5dB.
  - Distortion:  $\leq 0,005\%$  @ +4dBu, 20Hz-80KHz.
  - Absolute noise:  $\leq -85$ dBu @ 20Hz-20KHz.
  - Crosstalk:  $\geq 87$ dB @ 20Hz-20KHz.
- Analog outputs:
  - Nominal level: +4dBu.
  - Maximum level:  $\geq +24$ dBu.
  - Bandwidth: 20Hz-20Khz @ +/-0.5dB.
  - Distortion:  $\leq 0.006\%$  @ +4dBu, 20Hz-80KHz.
  - Absolute noise:  $\leq -87$ dBu @ 20Hz-20KHz.
  - Crosstalk:  $\geq 95$ dB @ 20Hz-20KHz.
- Digital inputs and outputs:
  - Input sampling frequency range: 32KHz-96KHz.
  - Output sampling frequency: 48KHz.
  - Line impedance: 110 Ohm AES3, 75 Ohm SPDIF.
  - Reference levels: 0dBFS = +24dBu.
  - Nominal level: -20dBFS.
  - Maximum level: 0dBFS.
  - Bandwidth: 20Hz-20Khz @ +/-0.05dB.

- Distortion:  $\leq 0.0006\%$  @ -20dBFS, 20Hz-80KHz.
- Absolute noise:  $\leq -125$ dBFS @ 20Hz-20KHz.

November 2020. Specifications subjected to evolutionary changes. Download the latest version of the manual at [www.aeq.es](http://www.aeq.es), [www.aeq.eu](http://www.aeq.eu) or [www.aeqbroadcast.com](http://www.aeqbroadcast.com).

## **5. A.E.Q. GUARANTEE.**

AEQ warrants that this product has been designed and manufactured under a Quality Assurance System. AEQ therefore warrants that the necessary test protocols to assure the proper operation and the specified technical characteristics of the product have been followed and accomplished.

This includes that the general protocols for design and production and the particular ones for this product are conveniently documented.

1.- The present guarantee does not exclude or limit in any way any legally recognized right of the client.

2.- The period of guarantee is defined to be twelve natural months starting from the date of purchase of the product by the first client.

To be able to apply to the established in this guarantee, it is compulsory condition to inform the authorized distributor or –to its effect- an AEQ Sales office or the Technical Service of AEQ within thirty days of the appearance of the defect and within the period of guarantee, as well as to facilitate a copy of the purchase invoice and serial number of the product.

It will be equally necessary the previous and expressed conformity from the AEQ Technical Service for the shipment to AEQ of products for their repair or substitution in application of the present guarantee.

In consequence, return of equipment that does not comply with these conditions will not be accepted.

3.- AEQ will at its own cost repair the faulty product once returned, including the necessary labour to carry out such repair, whenever the failure is caused by defects of the materials, design or workmanship. The repair will be carried out in any of the AEQ authorized Technical Service Centre. This guarantee does not include the freight charges of the product to or from such Authorized Technical Service Centre.

4.- No Extension of the Guarantee Period for repaired product shall be applied. Nor shall a Substituted Products in application of this Guarantee be subject to Guarantee Period Extension.

5.- The present guarantee will not be applicable in the following situations:  
improper use or Contrary use of the product as per the User or Instruction Manual; violent manipulation; exhibition to humidity or extreme thermal or environmental conditions or sudden changes of such conditions; electrical discharges or lightning; oxidation; modifications or not authorized connections; repairs or non-authorized disassembly of the product; spill of liquids or chemical products.

6.- Under no circumstances, whether based upon this Limited Guarantee or otherwise, shall AEQ, S.A. be liable for incidental, special, or consequential damages derived from the use or from the impossibility of using the product.

AEQ shall not be liable for loss of information in the disks or data support that have been altered or found to be inexact, neither for any accidental damage caused by the user or other persons manipulating the product.

## APPENDIX 1. INSTALLATION OF A DANTE NETWORK WITH AEQ MIXING CONSOLES AND NETBOX.

The installation will be described using two examples.

### A1.1. AEQ Audio over IP System for two digital studios and a Central Control.

This drawing represents a proposed installation for a small, two-studio radio station. The "Daisy Chain" IP wiring is represented in pink, running from one PC to the audio interface located in the central control, to the mixing console in studio one, from here to the shared studio interface and from there to the console in studio two.

The program audio for both studios as well as other required signals for the central control (such as clean-feeds for telephone systems, etc) are sourced from the NETBOX 8 audio outputs. The signals necessary for the studios, such as satellite downlink, audiocoders, tuners, etc. are routed to the NETBOX 8 inputs. Each console will also receive not only the NETBOX 8 incoming audio but also the aux and program sends from the other console. The two controls will share studio and in this a NETBOX 4 MH will be installed to provide the connectivity for the common microphones to consoles and their headphones outputs. ON-AIR signalling and the programmable keys of the studio remote panel will also be using the system network.

#### A1.1.1. Installation.

- Setup a PC with the control applications.
- Check the digital mixing consoles configuration.
- Wire the PC, consoles, NETBOX 8 AD and NETBOX 4 MH in "Daisy Chain" mode according to the diagram (or, preferably, in a star topology by using a switch).

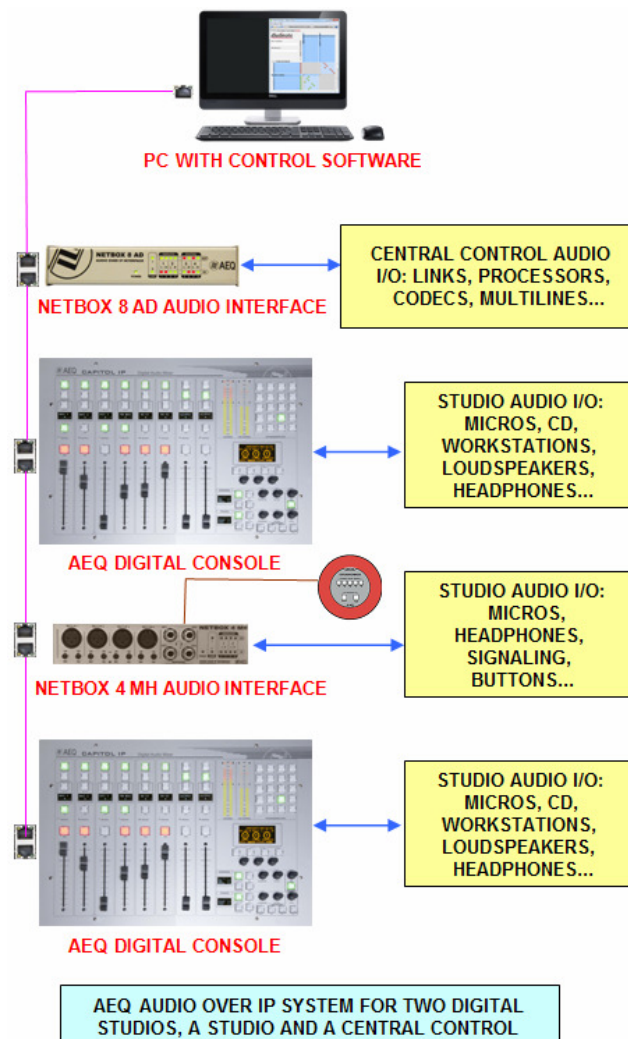

### A1.1.2. Turning ON.

- Turn the units on, configure them to send the program audio from the mixing consoles to the DANTE network, as well as to the NETBOX 8 AD and NETBOX 4 MH outputs. Start the "Dante Controller" application and send a test audio.
- Check that all units are displayed in the "Routing" window of the application. Check that the indicators in the "Signal" column within the "Transmit" tab in the "Device View" window corresponding to each device are illuminated green, indicating that the equipment is sending audio to the network.

### A1.1.3. Monitoring audio and creating routes.

- Open the "Dante Virtual Soundcard" for monitoring, or alternatively prepare some receiving channels in the consoles, NETBOX 8 AD or NETBOX 4 MH audio devices in order to receive and monitor audio.
- Subscribe the input channels of each device the output channels corresponding to the Master and NETBOX 8 AD outputs. In order to check the sound from the PC, also subscribe "Dante Virtual Soundcard" to the different master and NETBOX 8 output flows.

### A1.1.4. Optimization.

- Check the audio quality and, if possible, adjust its latency.
- You can substitute unicast flows by more than two multicast subscriptions (this is not mandatory in networks that are not too overloaded).
- Make switching groups, especially to switch audio pairs simultaneously.

## A1.2. AEQ Audio over IP system for medium to large sized stations.

This drawing represents a proposed installation of a medium to large sized radio station. The main wiring for IP is represented in pink, using an IP switch or group of switches when the wiring is dispersed or distributed in different zones or floors.

The backup IP wiring is represented in green. It can be easily installed through a second IP switch or group of switches (when the wiring is dispersed or distributed in different areas or floors of the building). All devices in the "AEQ Audio Over IP Routing System" feature two network interfaces that allow optional installation of system redundancy. To complete this redundancy, the PCs must be equipped with a second Ethernet adapter.

**IMPORTANT NOTE:** When there is a redundant network, primary and secondary interfaces must be connected to separated networks.

The schematic shows 5 different AoIP interfaces in the AEQ system:

- NETBOX 32 Channels interfaces.
- NETBOX 8 Channels interfaces.
- CAPITOL IP console.
- FR14 boards to connect FORUM and GRAND FORUM mixing consoles.
- XC24 boards to connect ATRIUM consoles and X\_CORE routers.

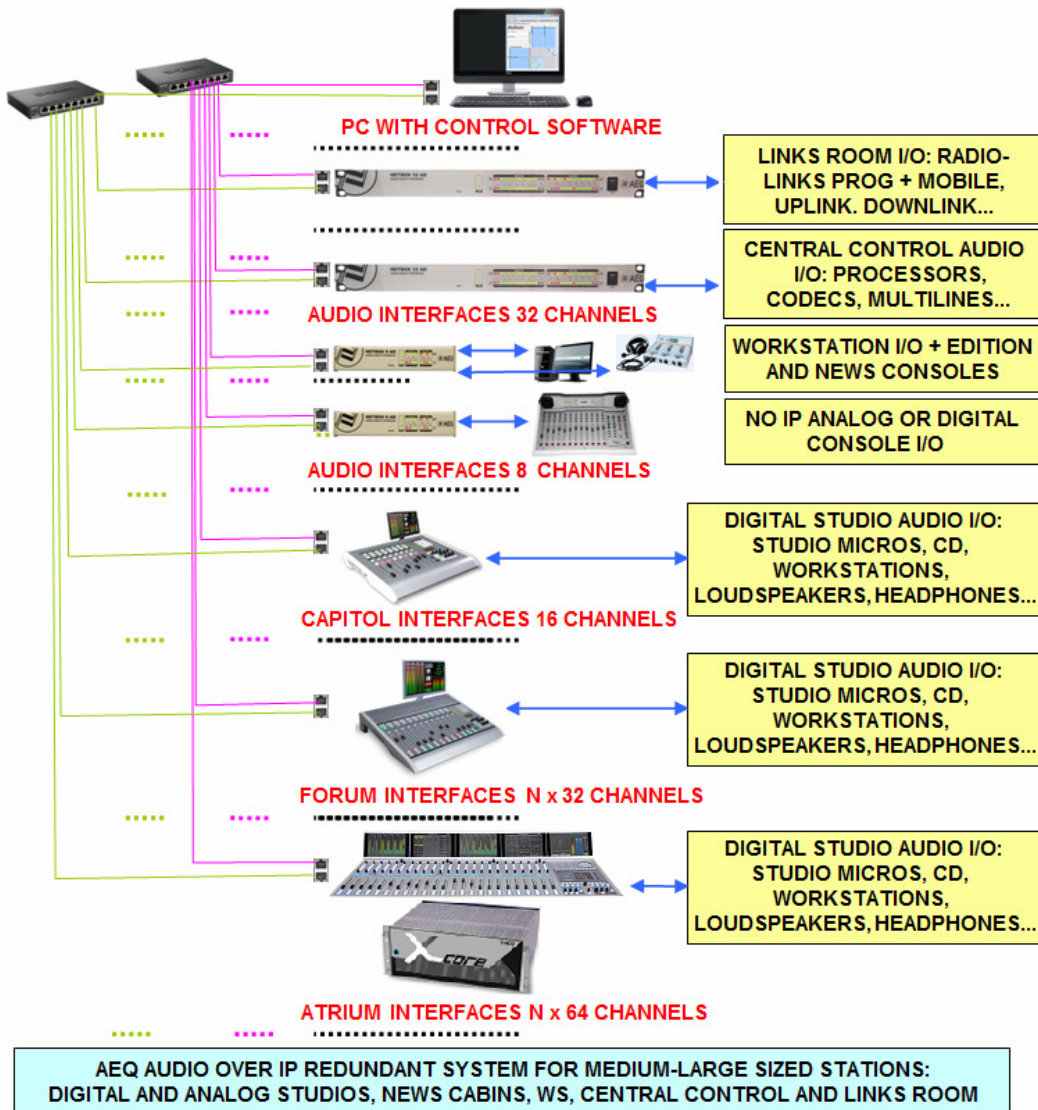

The program audio for all studios, as well as other required signals for the central control (such as clean-feed auxiliary sends for telephone systems, etc) are sourced from the NETBOX 32 AD audio outputs. The signals necessary for the studios, such as satellite downlink, audiocodecs, tuners or TV receivers, etc. are routed to the NETBOX 32 AD inputs.

One or several NETBOX 32 AD units can also be installed in the links dispatch. From this can be extracted, for example, signals going to radio links and satellite uplinks. Audio signals from the central control will be channeled into the system through them. Programs from all the studios (as well as any other signal required in central control such as auxiliary program sends or clean-feeds for telephone systems) are available on the NETBOX32 AD audio outputs. Signals required as studio channels such as satellite down-links, mobile units, etc. are connected tot the NETBOX 32 AD audio inputs.

A NETBOX 8 AD can be installed in News recording cabins or edit suites providing audio input and output for the audio workstations through a bi-directional USB link. Audio can also be provided to the mixing console using analog and digital I/O connections.

The same NETBOX 8 AD unit will provide IP connectivity to analog or digital studios without AEQ IP connectivity. This way, a station can be IP-connected without having to abandon existing equipment.

AEQ CAPITOL IP, FORUM and ATRIUM digital consoles can be provided with the corresponding multi-channel interfaces: One with 16 input + 16 outputs for CAPITOL IP, one or more with 32 input + 32 outputs for FORUM and one or more with 64 input + 64 outputs for ATRIUM. The most important outputs of each console can be routed to the multi-channel interfaces: master, auxiliary, clean feeds, etc. so they can be used at any other location within the station. At any moment and as required, it is possible to assign and route the signals with origin from studios, cabins, central control and links to the audio inputs of the interface.

The installation, turn-on, monitoring, routing creation and optimization tasks are equivalent to those described in the corresponding paragraphs in section A1.1, except for the differences related to the size and complexity of the system.

## APPENDIX 2. ADDITIONAL INFORMATION.

**NOTE:** This equipment complies with the limits for a Class A digital device, pursuant to part 15 of the **FCC** Rules. These limits are designed to provide reasonable protection against harmful interference when the equipment is operated in a commercial environment. This equipment generates, uses, and can radiate radio frequency energy and, if not installed and used in accordance with the instruction manual, may cause harmful interference to radio communications. Operation of this equipment in a residential area is likely to cause harmful interference in which case the user will be required to correct the interference at his own expense.



**Dante™** is a trademark of **Audinate Pty Ltd.**

Product includes license from Audinate Pty Ltd under US patent number(s) 7747725, 8005939, 7978696, 8171152 and others. Visit Audinate website for more details on Dante:  
<http://www.audinate.com/>