

# Largo & Allegro<sup>®</sup>

## Air Compressors

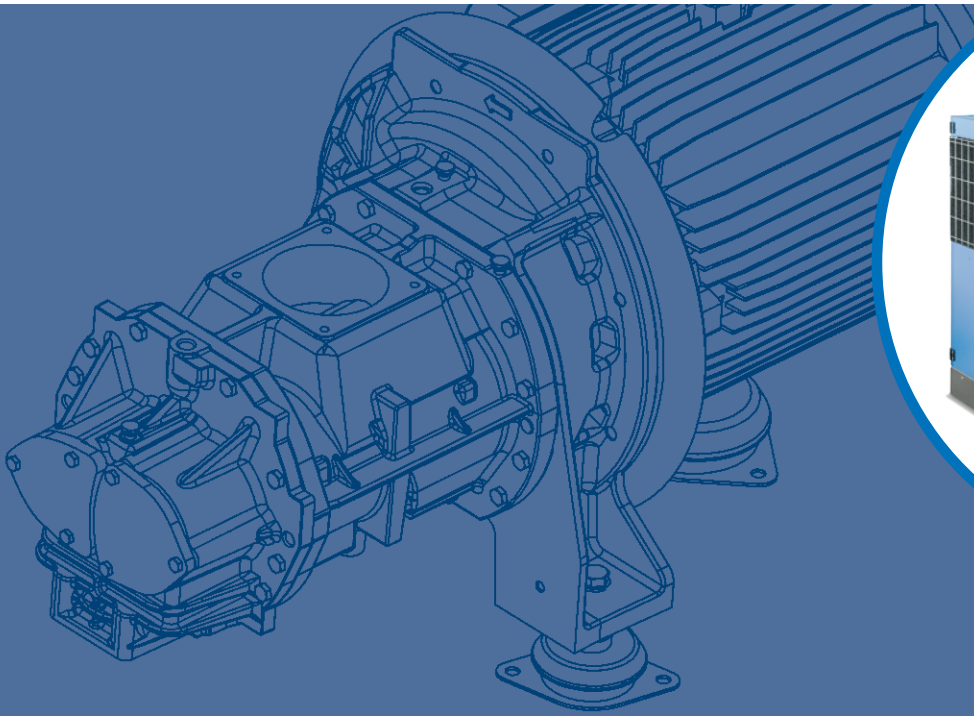

LARGO & ALLEGRO 11-22 E

**ALUP**  
Kompressoren

## ALUP's heritage

Founded in Germany in 1923, the company derives its name of the automotive products that were manufactured in the Köngen' mechanical workshop where ALUP came into existence: Auto-LUft-Pumpen. Only two years later, the first range of piston compressors was being developed, whilst in 1980 rotary screw compressors were added to the product offer.

Over time, experience grew and innovation prospered, leading to today's high quality product portfolio. As such, the name ALUP Kompressoren has become synonymous with innovative technology blended with a strong sense of tradition.

Today, ALUP Kompressoren is still operating out of the heart of Baden-Württemberg, where everything started in 1923.

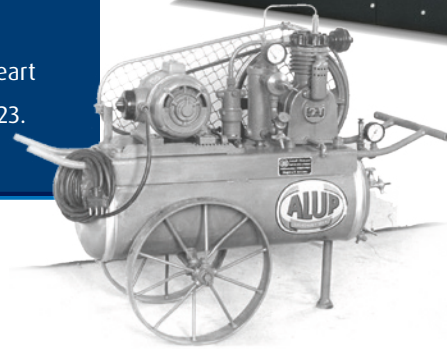

## Driven by technology Designed by experience

Discover what happens when a passion for technology is fused with hands-on industrial experience. Designs evolve towards more practical installation and maintenance, giving you the freedom to focus on your job. Product ranges include the exact machine you need, with the right options for your performance needs. Return on investment is ensured, while your carbon footprint shrinks. And, because we stay close to our customers, we're one step ahead when your needs change.

**INNOVATION  
HANDS-ON  
EXPERIENCE  
PEACE OF MIND  
TOTAL COST  
OF OWNERSHIP  
PARTNERSHIP**

## The power of the Largo & Allegro E range

*The Largo-Allegro 11-22 E range provides high quality compressed air for a wide range of industrial applications. As a result of continuous investment in product development, the range ensures industry leading performances in air delivery and energy efficiency, guaranteeing our customers unrivalled energy savings for their operations.*

### A wide product offer

- 4 power sizes: from 11 up to 22kW.
- 4 pressure variants for Largo fixed speed (7.5, 8.5, 10 and 13 bar).
- 2 pressure variants for Allegro variable speed (10 and 13 bar)
- 3 configurations:
  - Floor Mounted
  - Floor Mounted + Dryer (Plus)
  - Tank Mounted (500L) + Dryer (Plus)

### Industry leading performance

- A new and very powerful motor and air end combination provides top performances in Free Air Delivery and Specific Energy Consumption. This results in:
  - More air per kW.
  - Less energy per m<sup>3</sup>/h

### High serviceability

- All consumables are located behind one panel.
- Hinged removable front and rear doors to facilitate service.
- Large doors for easy access.
- Full access on both sides: front and back.
- Cleaning and servicing is a one person job.

### The options you need

- Graphic and integrated central controller.
- Energy recovery.
- ICONS (monitoring system)
- Integrated line filters
- ...and much more to customize your machine!

[www.alup.com](http://www.alup.com)

# The right fit for each customer

Check out these innovative features of the Largo & Allegro 11-22 E range and see how they provide you with a complete offer: high efficiency, easy maintenance and a low noise level.

## High quality drive train (gear transmission)

- Gear drive technology (1) for industry leading energy efficiency and reliability.
- No long-term losses thanks to the combination of screw compressor technology and gear drive.
- All gear sets are sized to reach the air end's optimal performance range.
- In-house designed air ends (2) with high performance (Air Delivery and Energy Consumption).
- Standard IP55 Class F IE3 motor (3) on Largo units.

## Optimal cooling and ventilation

- High efficiency radial fan (4) with low noise and low power consumption.
- Optimal cooling flow ensures low working temperatures.
- Oversized oil and air coolers (5) to keep low running temperatures even on hard conditions.



## High quality air delivery

- Internal cyclonic water separator with automatic drain (6) removes up to 90% of the moisture.
- An oversized dryer (7) isolated from the hot area of the compressor ensures maximum moisture removal.
- Optionally two line filters can be integrated in the package (G+C filters) ensuring clean air complying with ISO 8573-1: Class 1:4:2.

## Highly efficient air intake filtration and oil separation

- Fresh air is taken from the cold side (8) of the compressor improving compressing efficiency.
- Two micron incapsulated intake filters guarantee low pressure drop and only absolutely clean air inside the compressor air end.
- An oversized oil separation system (9) keeps pressure drop < 250 mBar, guaranteeing an energy efficient oil separation. This system also ensures low residual oil content < 2ppm, significantly reducing oil contamination in the down stream pneumatic equipment.

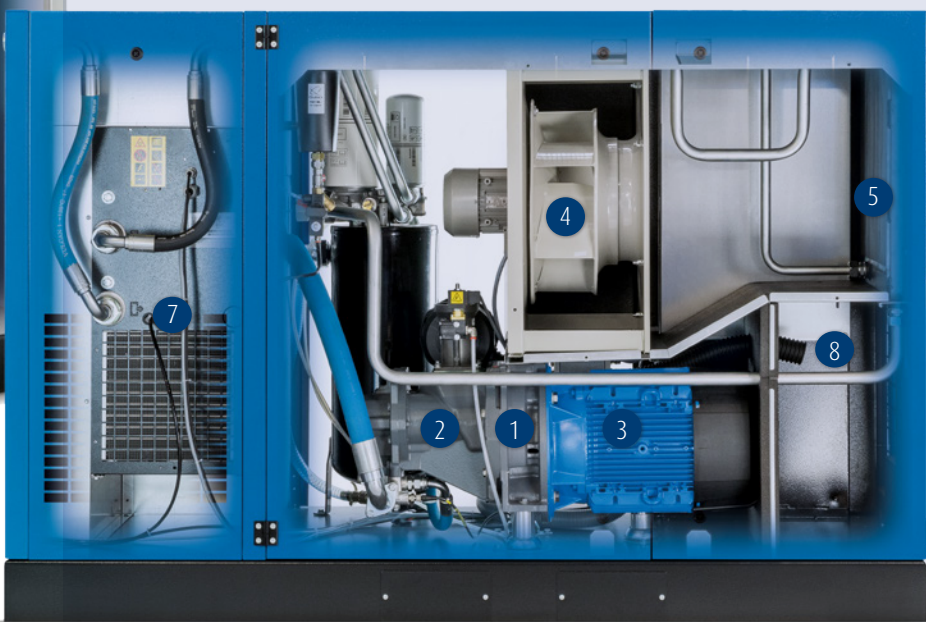

## Quiet operation

Thanks to the improved noise insulation, the compressor works very quietly and can be placed near the workplace.

## Time proven electrical package

- Designed according to IP 54, the electrical cubicle is protected against dust and water splashes, ensuring complete peace mind.
- Main components like the motor, electrical components and converter (10) are sourced from reputed suppliers with world wide support.



# How to optimize your energy consumption

Energy costs represent about 70% of the total operating cost of your compressor over a 5-year period. That is why reducing the operating cost of a compressed air solution is a major focus.

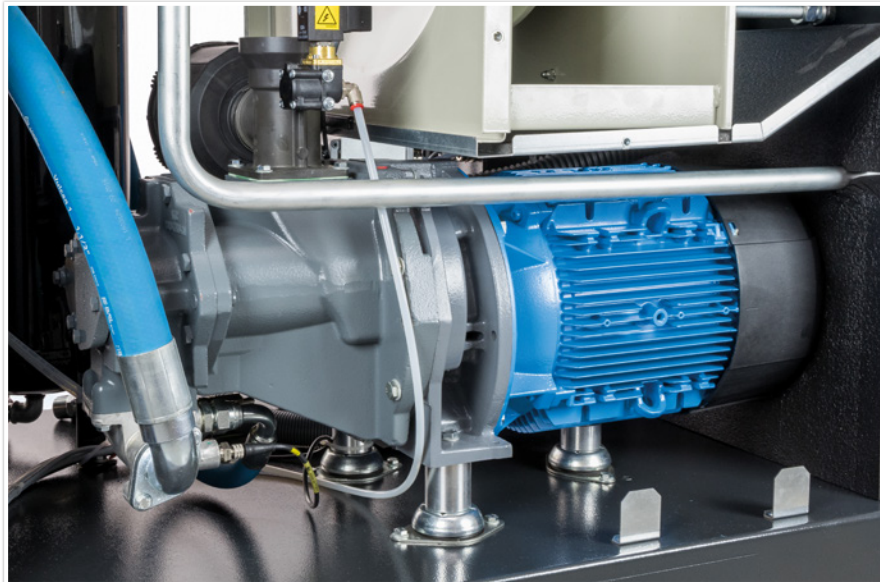

## Variable speed technology

For the right application, variable speed technology, can cut the energy bill of your compressor by up to 35%.

- The variable frequency drive compressor matches air supply with demand therefore reducing energy consumption when the demand is lower. If the demand is stable then the Air Control controller guarantees a fixed set pressure.
- No unload cycles above 20% load.
- No peak current due to soft start.
- Improved efficiency thanks to the new direct driven transmission

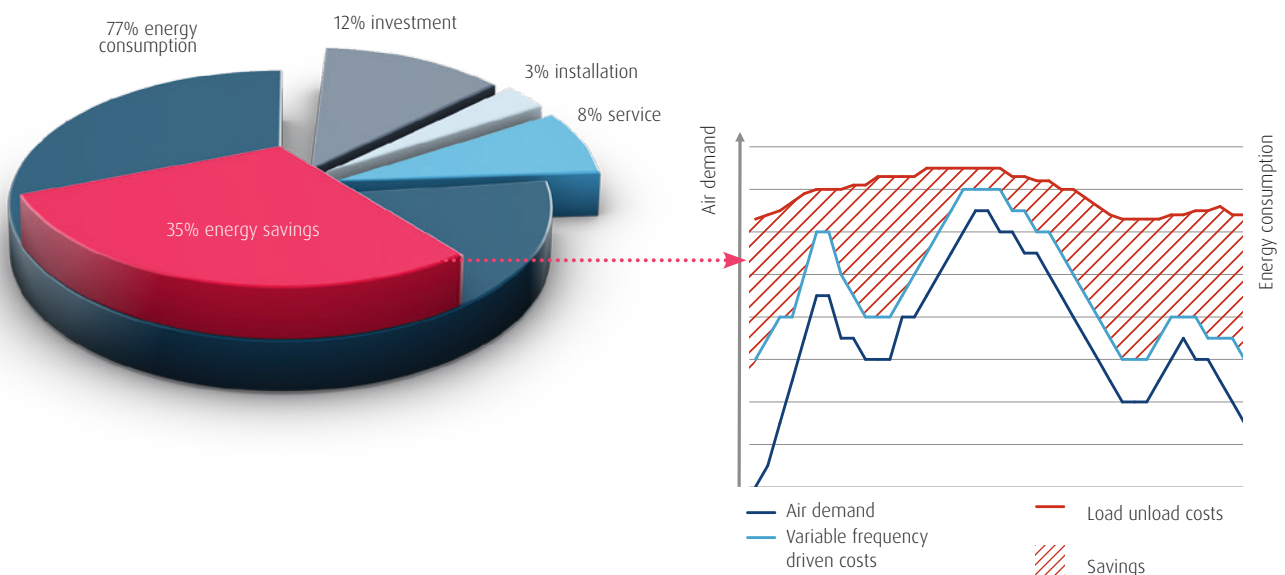

## Always in control with Air Control 5.0 and 5.1



### Air Control 5.0 (standard on Largo)

- Icon based display action
- Led status visualization.
- Digital I/O.
- Remote start stop, load-unload, emergency stop.
- Automatic restart after a power failure.
- Service indicator and fault management provide comprehensive messages to ease service diagnostics.
- Visualization through web browser using a simple Ethernet connection.



### Air Control 5.1 (standard on Allegro optional on Largo)

The Air Control 5.1 takes your control to the next level, offering additional functionalities:

- User-friendly graphic screens, data logging and storage on a memory card.
- Stop/start timers do not rely on the operator's action to save energy, but program the Air Control 5.1 controller to operate as your factory operates.
- Dual pressure band time scheduling for operation with different pressure bands, leading to energy savings.



### Meet the ALUP E series

Reducing the amount of energy required to produce products and services is the future. Lower energy consumption not only brings financial savings but is also seen as a sustainable solution for the problem of greenhouse gas emissions.

The ALUP E series incorporates the latest technological developments in compressed air and ensures industry leading performances in Free Air Delivery and Specific Energy Requirements.

Enjoy the performance and energy efficiency of the ALUP 11-22 E!

## Improve your energy recovery

*When air is compressed, heat is formed. The excess heat can be captured with an energy recovery option and channeled to other applications allowing you to save energy and cut costs.*

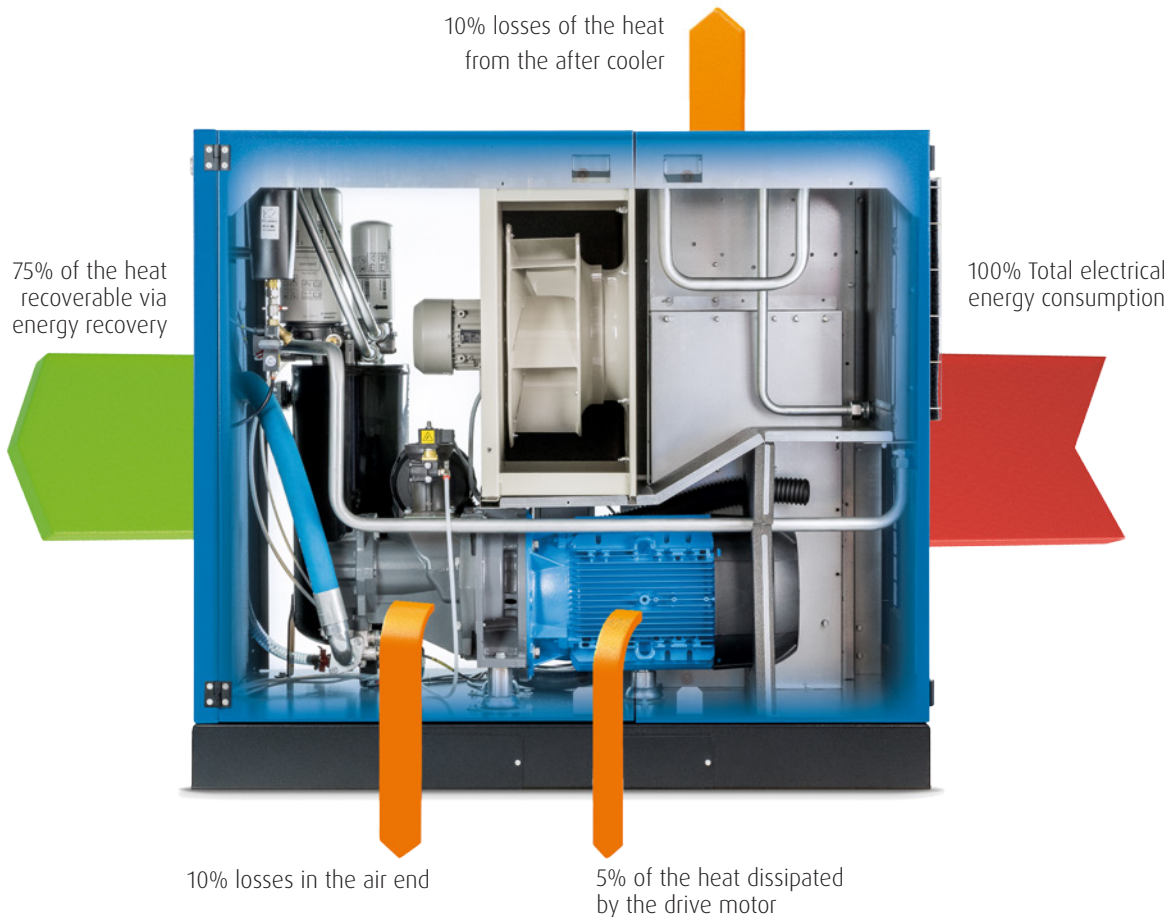

### Water cooling recovery

In the energy recovery units (optional) the oil circuit is pre-cooled with an oil/water heat exchanger. Water then becomes the fluid transport media to recover the oil temperature. The hot water resulting from this process can be used to heat radiators or water boilers, pre-heat supply water or hot tap water, and other industrial applications.

The energy recovery option integrates a heat exchanger on the oil circuit, which heats up the continuously pressurized water flow. The system is regulated automatically, and in case of limited water cooling capacity, the standard cooling system of the compressor will operate and backup the energy recovery device.

The energy recovery option is a simple mechanical system that requires no maintenance or electricity consumption, but offers you significant reductions in your energy costs.





## Options to optimize your operations

A wide range of options enables you to get the most out of your Largo & Allegro 11-22 E compressor.



### Air treatment

- **Built in dryer** to ensure dry air for the most demanding applications.
- **Integrated Line Filters (G+C filter)** to ensure a high level of air purity, in line with ISO 8573-1 Class 1:4:2.

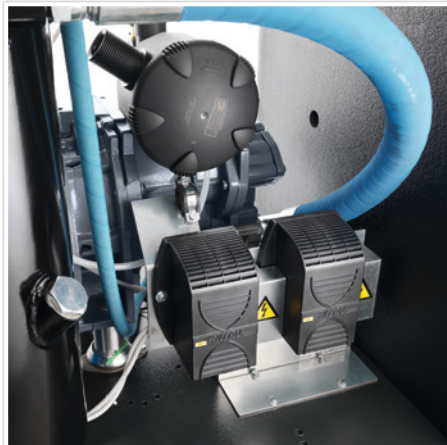

### Specific applications or configurations

- **Energy recovery pack** to recover up to 70% of the electrical energy consumption as warm water for showers, boilers etc.
- **Canopy heater** for installations exposed to low ambient temperatures.
- **Rain protection** for outdoor installations
- **Foodgrade oil** for food & beverage applications.
- **8000h oil** to ensure longer service intervals.

### Control & monitoring

- **Air Control 5.1 Graphic Control** (standard on Allegro - optional on Largo)
- **EControl6i** integrated multiple compressor control for 4/6 compressors (with Air Control 5.1 only).
- **ICONS** - remote monitoring system for additional convenience and compressor availability.

For further information on how our options can optimize your operations, please contact your local representative.

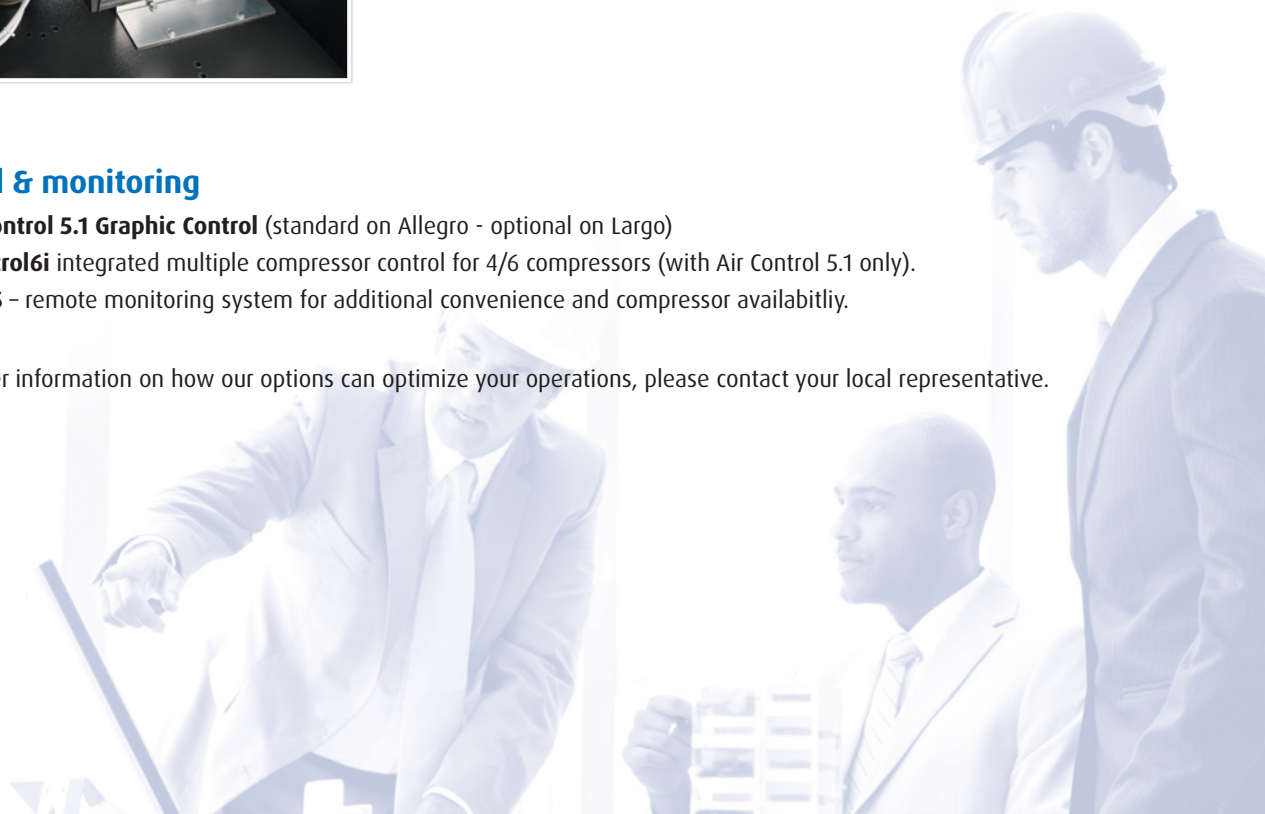

# Technical specifications

Fixed Speed

Model	Max. working pressure bar	Reference working pressure bar	Free Air Delivery @ reference conditions*			Motor power		Noise level** dB(A)	Weight		
			m³/h	l/s	cfm	kW	hp		FM	FM Plus	500L Plus
<b>Largo 11 E</b>	7,5	7,0	139	38,6	82	11	15	66	486	580	807
	8,5	8,0	116	32,3	68						
	10	9,5	104	29,0	61						
	13	12,5	81	22,6	48						
<b>Largo 15 E</b>	7,5	7,0	171	47,4	100	15	20	67	494	588	815
	8,5	8,0	157	43,6	92						
	10	9,5	135	37,4	79						
	13	12,5	115	32,0	68						
<b>Largo 19 E</b>	7,5	7,0	206	57,3	121	18,5	25	68	510	625	852
	8,5	8,0	195	54,2	115						
	10	9,5	170	47,2	100						
	13	12,5	147	40,8	86						
<b>Largo 22 E</b>	7,5	7,0	243	67,4	143	22	30	69	525	641	868
	8,5	8,0	224	62,1	132						
	10	9,5	202	56,1	119						
	13	12,5	176	49,0	104						

\* Unit performance measured according to ISO 1217, Annex C, latest edition.

\*\* Noise level measured according to ISO 2151 2004.



# Technical specifications

Variable Speed

Model	Max. working pressure bar	Free Air Delivery @ reference conditions												Motor power		Noise level dB(A)**	Weight		
		Min. FAD*				Max. FAD*											FM	FM Plus	500L Plus
		m³/h	l/s	m³/h	l/s	m³/h	l/s	m³/h	l/s	m³/h	l/s	m³/h	l/s	m³/h	l/s	kW	hp	kg	
<b>Allegro 11 E</b>	10	44	12,3	138	38,2	135	37,6	120	33,4	107	29,7	n.a.	n.a.	11	15	66	477	571	798
	13	42	11,7	115	31,9	112	31,2	113	31,5	103	28,6	81	22,6						
<b>Allegro 15 E</b>	10	57	15,8	178	49,5	173	48,1	161	44,6	148	41	n.a.	n.a.	15	20	67	485	579	806
	13	43	12,1	158	43,8	157	43,6	156	43,3	147	40,7	115	32,0						
<b>Allegro 19 E</b>	10	57	15,8	219	60,9	220	61,2	204	56,6	188	52,2	n.a.	n.a.	18,5	25	68	515	631	858
	13	46	12,8	193	53,7	192	53,4	190	52,9	183	50,9	147	40,8						
<b>Allegro 22 E</b>	10	57	15,9	263	73	265	73,6	240	66,7	218	60,5	n.a.	n.a.	22	30	69	531	647	874
	13	51	14,3	229	63,7	227	63,1	227	63	217	60,3	176	49,0						

\* Unit performance measured according to ISO 1217, Annex C, latest edition.

\*\* Noise level measured according to ISO 2151 2004.

## Dimensions Fixed Speed & Variable Speed

Largo & Allegro	Length	Width	Height
	mm	mm	mm
<b>Floor Mounted units</b>	1432	840	1278
<b>Floor Mounted units with dryer (plus)</b>	1926	840	1278
<b>Tank Mounted units (500L) with dryer (plus)</b>	1926	840	1900





DRIVEN BY TECHNOLOGY DESIGNED BY EXPERIENCE



**CONTACT YOUR LOCAL  
ALUP KOMPRESSOREN  
REPRESENTATIVE**



Care. Trust. Efficiency.

**Care.**

Care is what service is all about: professional service by knowledgeable people, using high-quality original parts.

**Trust.**

Trust is earned by delivering on our promises of reliable, uninterrupted performance and long equipment lifetime.

**Efficiency.**

Equipment efficiency is ensured by regular maintenance. Efficiency of the service organization is how Original Parts and Service make the difference.

6999640440