

# Largo & Allegro

## Rotary Screw Compressors

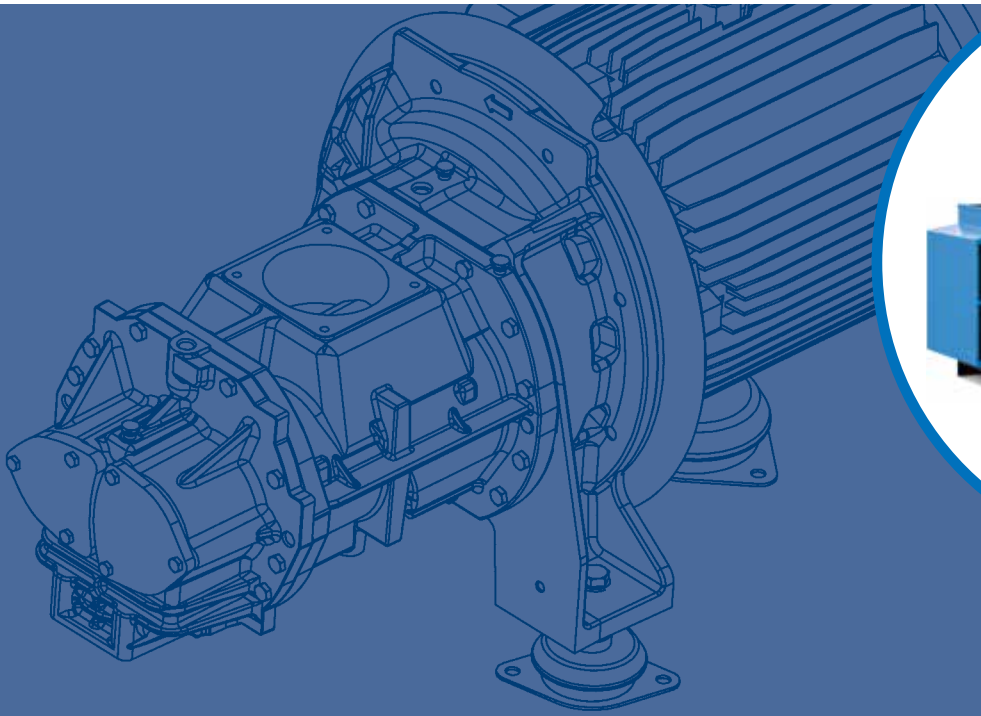

Largo & Allegro 15-25

**ALUP**  
Kompressoren



## ALUP's heritage

Founded in Germany in 1923, the company derives its name from the automotive products that were manufactured in the Köngen' mechanical workshop where ALUP came into existence: Auto-LUft-Pumpen. Only two years later, the first range of piston compressors was being developed, whilst in 1980 rotary screw compressors were added to product offer.

Over time, experience grew and innovation prospered, leading to today's high quality product portfolio. As such, the name ALUP Kompressoren has become synonymous with innovative technology blended with a strong sense of tradition.

Today, ALUP Kompressoren is still operating out of its home town Köngen, where everything started in 1923.

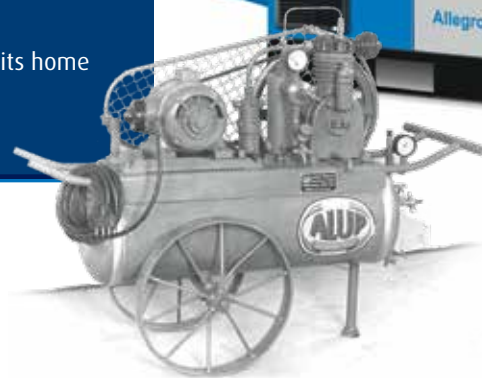

## Driven by technology Designed by experience

Discover what happens when a passion for technology is fused with hands-on industrial experience. Designs evolve towards more practical installation and maintenance, giving you the freedom to focus on your job. Product ranges include the exact machine you need, with the right options for your performance needs. Return on investment is ensured, while your carbon footprint shrinks. And, because we stay close to our customers, we're one step ahead when your needs change.

**INNOVATION  
HANDS-ON  
EXPERIENCE  
PEACE OF MIND  
TOTAL COST  
OF OWNERSHIP  
PARTNERSHIP**

## The range that meets all your requirements

*With the Largo & Allegro range you obtain an efficient, reliable and complete solution which fits a wide range of compressed air requirements.*

### A wide offer for you

- Available power sizes from 20 up to 35 hp.
- One pressure variant (5,5-12,5 bar) for Allegro 15-25.

### High efficiency transmissions

- Reduced energy consumption compared to belt driven technology.
- Low noise levels: the Largo & Allegro can be installed close to the workplace.
- Longer service intervals compared to belt technology.

### Easy accessibility and installation

- Easy to service thanks to the large hinged doors and removable panels.
- Easy to install thanks to a high variety of configurations and scope of supply.

### The options you need

- Graphic and integrated central controller.
- Energy recovery.
- 8000h oil.
- Connectivity - ICONS box.
- Canopy heater.
- Food grade oil.
- Compressed air filter to improve the air quality.
- WSD to protect your dryer from moisture.
- ...and much more to customize your machine!

[www.alup.com](http://www.alup.com)

## The right fit for each customer

Check out these innovative features of the Largo & Allegro 15-25 range and see how they provide you with a complete offer: high efficiency, easy maintenance and a low noise level.

### High quality drive train (gear and direct transmission)

- Gearbox technology for great energy efficiency and reliability installed on the Largo 15-25 units.
- No long-term loss thanks to the combination of screw rotors and gearbox technology.
- Direct driven transmission (1) for outstanding energy efficiency and reliability installed on the Allegro 15-25 units.
- In-house designed element with high performance (specific energy requirements and FAD) (2).
- Standard IP 55 class F IE3 motor for Largo 15-25 (3).
- High frequency converter duty motor for Allegro 15-25 (4).
- Primary suppliers for main outsourced components like motors and converters (5), with world wide support.

### Highly efficient air intake filtration and oil separation

- Fresh air taken from the cold side of the compressor to improve efficiency.
- Two micron encapsulated intake filters guarantee only clean air enters the compressor (6).
- Spin on oil separation (7) with oversized oil vessel (8) for a pressure drop < 250 mbar.





## Optimal ventilation and oversized cooler

- Improved cooling flow results in a lower working temperature.
- A separated air flow offers you an efficient motor and inverter cooling together with a long life time of oil, components and compressor (9).
- Optimal ventilation flow is assured with low energy consumption.
- Oversized oil and air cooler for better cooling and lower operating temperature (10).

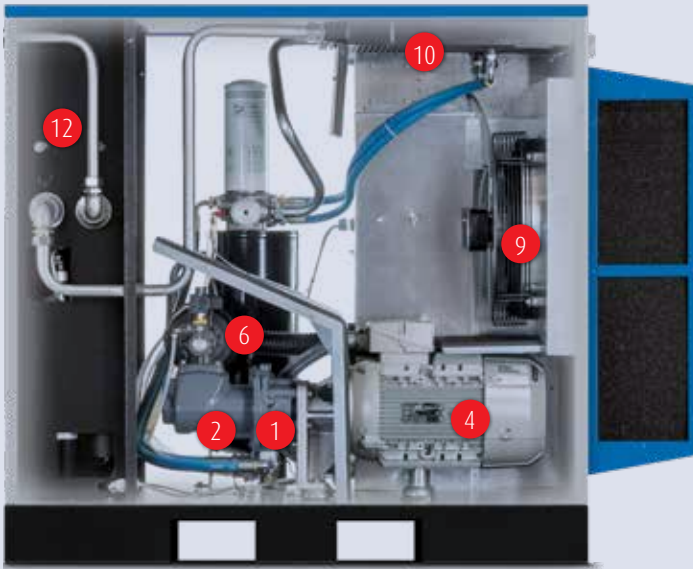

## Integrated inverter

- Easy accessible integrated inverter drive (5).
- Optimal FAD range control.
- New cubicle cooling system to improve electrical device reliability.

## Quiet operation

Thanks to the improved noise insulation, the compressor works very quietly and can be placed near the workplace.

## Air quality

- Internal water separator (11) with automatic drain removes up to 90% of compressed air moisture (standard with dryers).
- Oversized dryer (12) installed in the cold part of the unit to ensure the maximum of moisture removal.



# How to optimize your energy consumption

Energy costs represent about 70% of the total operating cost of your compressor over a 5-year period. That is why reducing the operating cost of a compressed air solution is a major focus.

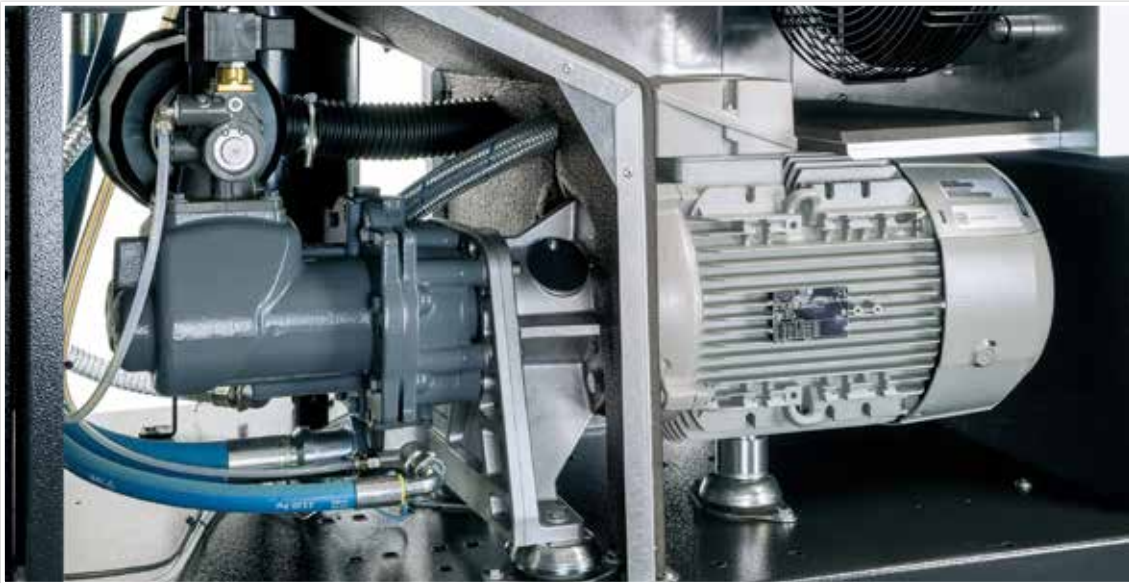

## Variable speed technology

For the right application, variable speed technology, can cut the energy bill of your compressor by up to 30%.

- The variable frequency drive compressor matches air supply with demand therefore reducing energy consumption when the demand is lower. If the demand is stable then the controller guarantees a fixed set pressure.
- No unload cycles above 20% load.
- No peak current due to soft start.
- Improved efficiency thanks to the new direct driven transmission

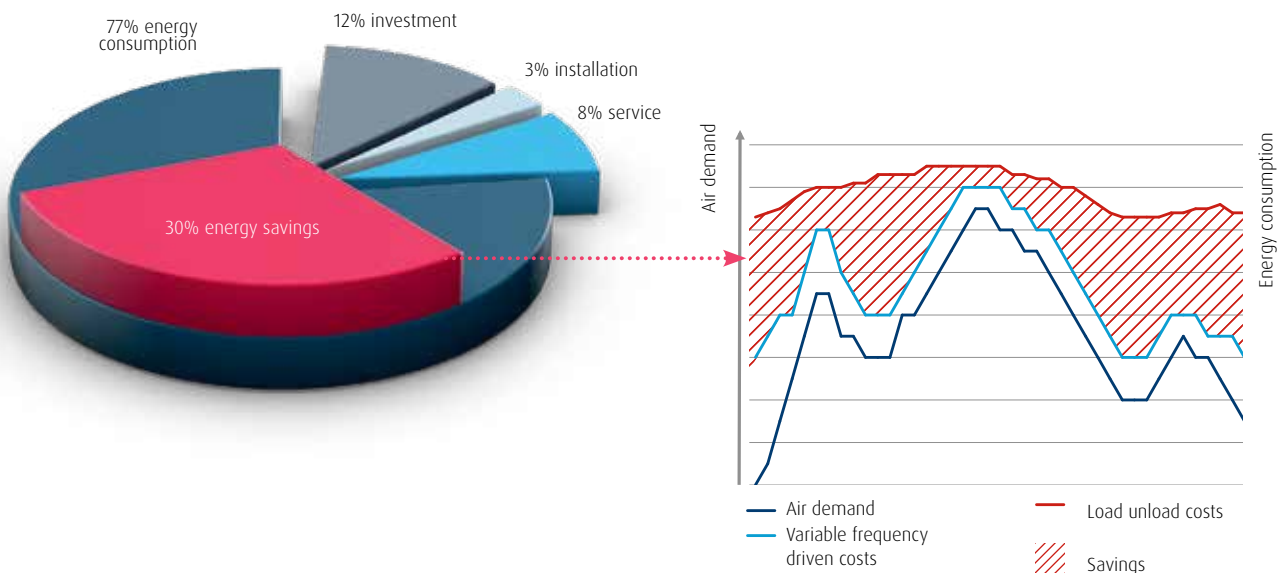

## Always in control with Air Control 5.0 & 5.1



### Air Control 5.0 (standard on Largo)

- Icon based display action
- Led status visualization.
- Digital I/O.
- Remote start stop, load-unload, emergency stop.
- Automatic restart after a power failure.
- Service indicator and fault management provide comprehensive messages to ease service diagnostics.
- Visualization through web browser using a simple Ethernet connection.



### Air Control 5.1 (standard on Allegro, optional on Largo)

The Air Control 5.1 takes your control to the next level, offering additional functionalities:

- User-friendly graphic screens, data logging and storage on a memory card.
- Stop/start timers do not rely on the operator's action to save energy, but program the Air Control 5.1 controller to operate as your factory operates.
- Dual pressure band time scheduling for operation with different pressure bands, leading to energy savings.

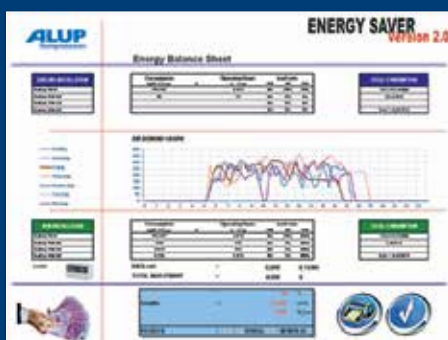

### Energy audit

Knowing what compressor is right for your application is critical to minimizing the energy consumption. With our Energy Audit we can simulate your compressed air needs and then consult you on the best solution for your needs.

For more information, please contact your local Alup representative.

## Improve your energy recovery

When air is compressed, heat is formed. The excess heat can be captured with an energy recovery option and channeled to other applications allowing you to save energy and cut costs.

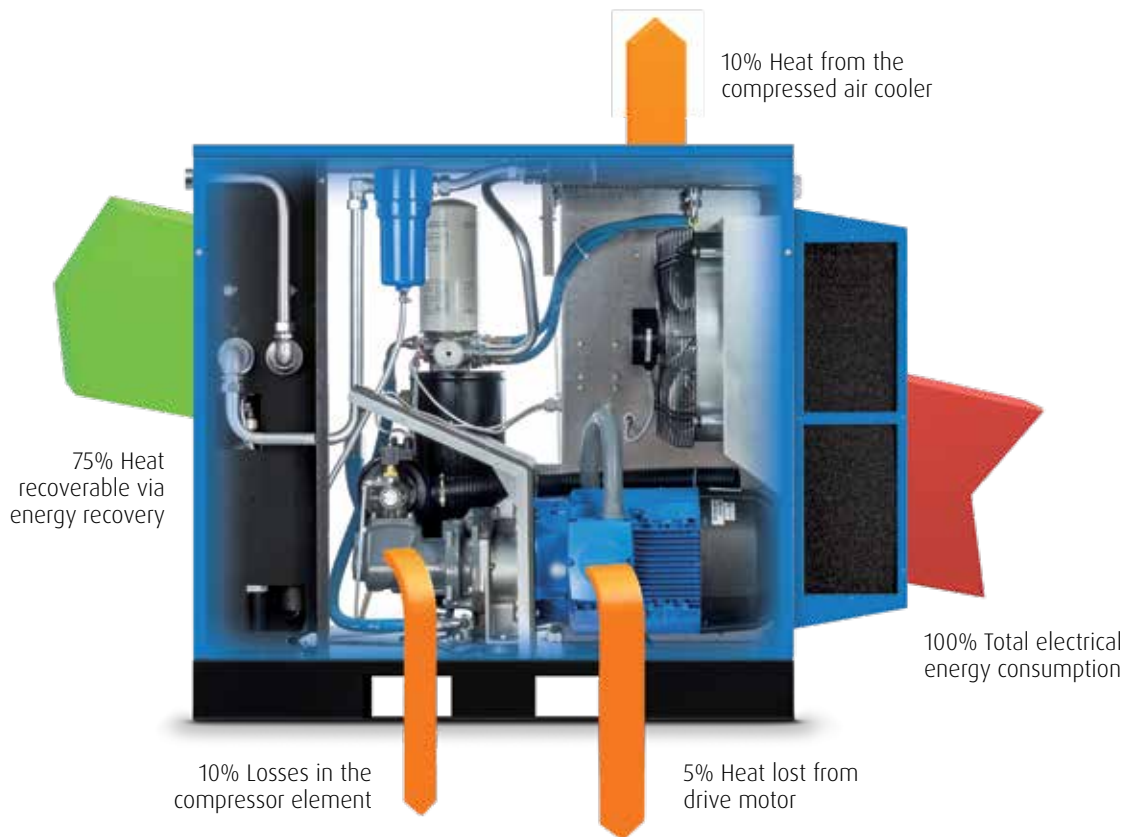

### Water cooling recovery

In the energy recovery units (optional) the oil circuit is pre-cooled with an oil/water heat exchanger. Water then becomes the fluid transport media to recover the oil temperature. The hot water resulting from this process can be used to heat radiators or water boilers, pre-heat supply water or hot tap water, and other industrial applications.

The energy recovery option integrates a heat exchanger on the oil circuit, which heats up the continuously pressurized water flow. The system is regulated automatically, and in case of limited water cooling capacity, the standard cooling system of the compressor will operate and backup the energy recovery device.

The energy recovery option is a simple mechanical system that requires no maintenance or electricity consumption, but offers you significant reductions in your energy costs.





## Options to optimize your operations

A wide range of options enables you to get the most out of your Largo/Allegro 15-25.



### Air quality

- **Internal water separator with floating drain** reduces up to 90% of the compressed air moisture. Standard on T units.
- **Line filter** for oil and dust removal down to 0.1 ppm for plus versions.
- **Heavy duty air intake filtration** prevents dust entering the pneumatic circuit in very dusty environments.
- **Canopy heater** for low temperature installation.
- **Electronic zero loss drain** for water separator to easily drain the condensate without any compressed air loss.
- **Food grade oil** for food & beverage applications



### Efficiency

- **Energy recovery pack** to recover up to 70% of the electrical energy consumption as warm water for showers, boilers etc.
- **8000h oil**

### Control & monitoring

- **Air Control 5.1 Graphic Control** (standard on Allegro, optional on Largo)
- **EControl6i** integrated multiple compressor control for 4/6 compressors (with Air Control 5.1 only).
- **Remote monitoring** for additional convenience.

For further information on how our options can optimize your operations, please contact your local representative.

# Technical specifications Largo 15-25

Fixed Speed

| Model           | Max. working pressure<br>*** | Free Air Delivery @ reference conditions * |                   |      |       | Motor power |    | Noise level<br>** | Weight |       |     |
|-----------------|------------------------------|--------------------------------------------|-------------------|------|-------|-------------|----|-------------------|--------|-------|-----|
|                 |                              | bar                                        | m <sup>3</sup> /h | l/s  | l/min | cfm         | kW |                   | hp     | dB(A) | FM  |
| <b>Largo 15</b> | 7,5                          | 165                                        | 45,9              | 2751 | 97    | 15          | 20 | 66                | 345    | 400   | 575 |
|                 | 8,5                          | 155                                        | 43,1              | 2588 | 91    |             |    |                   |        |       |     |
|                 | 10                           | 137                                        | 38,2              | 2289 | 81    |             |    |                   |        |       |     |
|                 | 13                           | 119                                        | 33,1              | 1986 | 70    |             |    |                   |        |       |     |
| <b>Largo 19</b> | 7,5                          | 202                                        | 56,2              | 3372 | 119   | 18,5        | 25 | 67                | 370    | 430   | 605 |
|                 | 8,5                          | 192                                        | 53,3              | 3198 | 113   |             |    |                   |        |       |     |
|                 | 10                           | 176                                        | 49,0              | 2940 | 104   |             |    |                   |        |       |     |
|                 | 13                           | 140                                        | 38,8              | 2326 | 82    |             |    |                   |        |       |     |
| <b>Largo 22</b> | 7,5                          | 234                                        | 64,9              | 3897 | 138   | 22          | 30 | 68                | 385    | 445   | 620 |
|                 | 8,5                          | 226                                        | 62,7              | 3760 | 133   |             |    |                   |        |       |     |
|                 | 10                           | 198                                        | 55,0              | 3301 | 117   |             |    |                   |        |       |     |
|                 | 13                           | 168                                        | 46,6              | 2796 | 99    |             |    |                   |        |       |     |
| <b>Largo 25</b> | 7,5                          | 258                                        | 71,6              | 4296 | 152   | 26          | 35 | 70                | 400    | 460   | 635 |
|                 | 8,5                          | 244                                        | 67,8              | 4068 | 144   |             |    |                   |        |       |     |
|                 | 10                           | 228                                        | 63,4              | 3804 | 134   |             |    |                   |        |       |     |
|                 | 13                           | 200                                        | 55,5              | 3330 | 118   |             |    |                   |        |       |     |

\* Unit performance measured according to ISO 1217, Annex C, latest edition

\*\* Noise level measured according to ISO 2151:2004 using ISO 9614/2

\*\*\* Reference working pressure: 7 - 8 - 9,5 - 12,5 bar



# Technical specifications Allegro 15-25

Variable Speed

| Model             | Min. working pressure<br>Bar/psi | Max. working pressure<br>Bar/psi | Min. FAD* |     |       |       |      |       |         |      |       |         |      |       |          |      |       | Motor power |     | Noise level<br>dB(A) | Weight |      |        |
|-------------------|----------------------------------|----------------------------------|-----------|-----|-------|-------|------|-------|---------|------|-------|---------|------|-------|----------|------|-------|-------------|-----|----------------------|--------|------|--------|
|                   |                                  |                                  | 7 Bar     |     |       | 7 Bar |      |       | 8,5 Bar |      |       | 9,5 Bar |      |       | 12,5 Bar |      |       |             |     |                      | FM     | FM D | 500L D |
|                   |                                  |                                  | m³/h      | l/s | l/min | m³/h  | l/s  | l/min | m³/h    | l/s  | l/min | m³/h    | l/s  | l/min | m³/h     | l/s  | l/min | m³/h        | l/s | l/min                | kg     | kg   | kg     |
| <b>Allegro 15</b> | 5,5 / 80                         | 13 / 189                         | 47        | 13  | 780   | 178   | 49,5 | 2969  | 160     | 44,5 | 2672  | 152     | 42,3 | 2539  | 131      | 36,4 | 2182  | 15          | 20  | 67                   | 325    | 380  | 555    |
| <b>Allegro 19</b> | 5,5 / 80                         | 13 / 189                         | 47        | 13  | 780   | 215   | 59,6 | 3575  | 197     | 54,8 | 3291  | 185     | 51,5 | 3091  | 149      | 41,4 | 2485  | 18,5        | 25  | 68                   | 340    | 400  | 575    |
| <b>Allegro 22</b> | 5,5 / 80                         | 13 / 189                         | 47        | 13  | 780   | 240   | 66,7 | 4000  | 221     | 61,3 | 3678  | 207     | 57,6 | 3454  | 185      | 51,5 | 3091  | 22          | 30  | 69                   | 345    | 410  | 585    |
| <b>Allegro 25</b> | 5,5 / 80                         | 13 / 189                         | 47        | 13  | 780   | 255   | 70,7 | 4242  | 238     | 66,2 | 3969  | 229     | 63,6 | 3818  | 200      | 55,5 | 3333  | 26          | 35  | 70                   | 365    | 425  | 600    |

\* Unit performance measured according to ISO 1217, Annex C, latest edition

\*\* Noise level measured according to ISO 2151:2004 using ISO 9614/2

## Dimensions Fixed Speed & Variable Speed

| Model fixed + variable speed | Length | Width | Height |
|------------------------------|--------|-------|--------|
|                              | mm     |       |        |
| <b>Floor mounted</b>         | 1395   | 835   | 1220   |
| <b>Floor mounted + dryer</b> | 1545   | 835   | 1220   |
| <b>500L + dryer</b>          | 1940   | 835   | 1835   |





DRIVEN BY TECHNOLOGY DESIGNED BY EXPERIENCE



CONTACT YOUR LOCAL  
ALUP REPRESENTATIVE

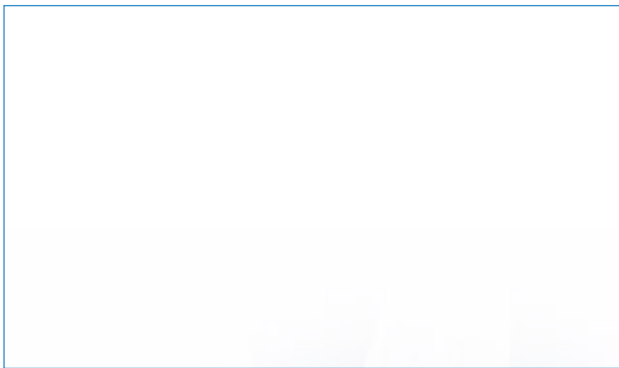

Care. Trust. Efficiency.

**Care.**

Care is what service is all about: professional service by knowledgeable people, using high-quality original parts.

**Trust.**

Trust is earned by delivering on our promises of reliable, uninterrupted performance and long equipment lifetime.

**Efficiency.**

Equipment efficiency is ensured by regular maintenance. Efficiency of the service organization is how Original Parts and Service make the difference.



[www.alup.com](http://www.alup.com)