

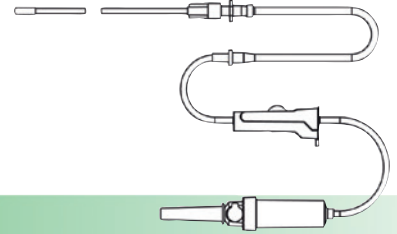

DENTA Chirurgie

1 JUNI - 31 AUGUSTUS 2021 www.denta.be



ULTRADENT

DENTAL UNITS. MADE IN GERMANY.



PIEZOTOME CUBE



SATELEC
ACTEON

ULTRADENT

DENTAL UNITS. MADE IN GERMANY.

U 6000 S.

De premium standard.

Deze premium behandelunit is indrukwekkend, niet alleen door zijn spectaculair volledig wit design, maar ook door zijn revolutionair vision U Multimedia systeem. De elegante combinatie van technologie en praktijk helpt om nieuwe doelstellingen te bereiken. Voor de tandartsassistent is er een full-touch display beschikbaar. Beleef dit topmodel van Ultradent in uw praktijk.

Uw team en patiënten zullen verrast zijn.



ULTRADENT PREMIUM CLASS U 6000 S

bestaande uit: tandartsunit ULTRADENT U6000S, waterenheid, aanbouwdragers, aansluitdelen, patiëntenzetel ULTRADENT UD2021

32.312,00

TANDARTSELEMENT

3F spuit standaard
turbineslang met licht
inductiemotor K2
F10 pedaal

945,00

1.751,00

2.918,00

980,00

WATEREENHEID

spuwkomventiel en selectief ventiel voor natte zuigmotor type VS(A)300

889,00

ASSISTENTENELEMENT

assistentenelement Kompakt Premium
incl. selectieve afzuiging (8412) en waterspoeling van de zuigslangen (8413)

2.116,00

BEHANDELINGSLAMP

Solaris 2 LED
lampenzuil

3.947,00

676,00

TOTAAL

€ 46 534,00

***Vanaf € 509,08 per maand op 120 maanden**

Stuntprijs toonzaalmodel : 0497 44 56 22 of lisc@denta.be

*Financiële leasing, prijs onder voorbehoud van wijzigingen

OPTIES

TANDARTSELEMENT

6F spuit

turbineslang Advanced Air met licht, inclusief snelkoppeling en Hybrid handstuk

inductiemotor KL7S (300 - 40 000 t/min.) (1e) – steriliseerbaar

endo functie

**chirurgiemotor (300 - 40.000 t/min.), W&H IMPLANTMED met hoekstuk (20:1).
Motor & slang autoclaveerbaar. Enkel mogelijk met F10 pedaal**

irrigatiepomp voor steri-water, zonder vloeistofreservoir

tandsteenverwijderaar Satelec Newtron SLIM LED

F9 pedaal (draadloos)

ASSISTENTENELEMENT

dubbele scharnierarm voor satelliet

polymerisatielamp ScanWave

AANSLUITDELEN

systeem ter voorkoming van contaminatie van het leidingwater (DVGW) (NEN-EN1717),
'Permanent-Intensief' desinfectiesysteem van de instrumentenslangen

PATIENTENZETEL

bekleding 'Soft'

memory-kopsteun type 'FLEX' magnetisch

MULTIMEDIA VISION-U

Interactieve 21,5 inch touchscreen Multimediasysteem met Smart-Touch-Gesture te bedienen

Full HD monitor, voldoet aan de eisen voor röntgenbeeld diagnose

Monitor uit glas, met speciale antireflex Touch folie geschikt voor gebruik met handschoenen

Digitale intra-orale camera met autofocus, barcode en QR code lezer

- resolutie livebeeld 824 x 514 pixels bij 20 frames (beelden per seconde)

- resolutie stil beeld: 1276 x 796 pixels

Geïntegreerd onderhoud- en service platform

OPTIES INDIEN DROGE ZUIGMOTOR

i.p.v. spuwkomventiel en selectief ventiel Dürr

water/lucht separator Dürr CS1, selectief ventiel, spoelenheid en ontluchtingskit

amalgaamafscheider Dürr CAS1, selectief ventiel, spoelenheid en ontluchtingskit

HOEK- EN HANDSTUKKEN Te bespreken

TURBINE Te bespreken

Piezotome CUBE

A41280

- Handstuk CUBE LED
- kit Essentieel :
BS1S, BS4, SL1, SL2, SL3, LC2,
- dynamometrische sleutel
- meerfunctie pedaal, drager
- handstukhouder
- 2 autoclaveerbare irrigatie lijnen
- 5 autoclaveerbare irrigatie clips
- 15 steriele perforators

Adviesprijs: 6696,50



STUNTPRIJS
4985,00



Implant Center 2

A34090 LED micro-motor met kabel,
2 houders voor handstukken, 2 autoclaveerbare irrigatieslangen,
30 perforators, 2 flessenhouders, progressieve voetpedaal +

Adviesprijs: 12795,00



STUNTPRIJS
8585,00



A34089 INTRALIFT 2 SET

Tips TKW1, TKW2, TKW3, TKW4, TKW5, een autoclaveerbare metalen houder en een autoclaveerbare universeelsleutel.

Adviesprijs: 1201,30



PROMO
790,00

A40703 ESSENTIAL PACK

- Sterilisatiedoos
- Autoclaveerbaar Piezotome LED handstuk
- Snoer
- Essential Set
(6 tips: BS1S, BS4, SL1, SL2, SL3 en LC2)
- Easytorque momentsleutel.

Adviesprijs: 2593,00



PROMO
1985,00

iChiropro set with Micro-Series CA 20:1 L

A37862

- Console iChiropro
- Micromotor MX-i LED met 3 jaar waarborg
- Hoekstuk met licht CA 20:1 L Micro-serie
- Kabel MX-i LED
- Pedaal
- 10 Irrigatielijnen
- 2 Steriele beschermfolies voor iPad
- 1 Onderhoudspakket :
(1 x Spraynet, 1 x Lubrifluid en 1 x Aquacare)

Adviesprijs: 5847,95

iPad NIET inbegrepen.



PROMO
4299,00

Chiropro Plus with Micro-Series CA 20:1 L

A44256

- Console Chiropro Plus
- Hoekstuk CA20:1L Micro-Series
- MX-i Led plus motor
- MX-i Led plus Slang
- Voetpedaal
- Handstuk houder
- 5 Irrigatielijnen
- 2 Beschermingsfilms
- 1 Onderhoudspakket :
(1 x Spraynet, 1 x Lubrifluid en 1 x Aquacare)

Adviesprijs: 4870,89



PROMO
3499,00

Implantmed Plus SI-1023 met LED+ licht

A40613

Geschikt voor implantologie en kaakchirurgie.
 Veilig, eenvoudig, flexibel.
 Draadsnijfunctie, Automatische torquecontrole,
 Intuïtieve gebruikersinterface.
 Nieuw pompdesign, Draadloze voetbediening.
 Perfecte balans -
 chirurgische hand- en hoekstukken met Mini Led+.
 Optioneel aan te sluiten W&H Osstell ISQ module.

Adviesprijs: 4020,00

PROMO
3589,00

**W&H Surgical Trolley**

- + Implantmed Plus SI-1023 with light
 - + Piezomed SA-320
 - + Wireless foot control
 - + One surgical instrument, choose between WS-75 L and S-11 L
 - + Surgical trolley
 - > One for all
- Control the functions of the Implantmed and Piezomed with only one foot control.
- > Absolute freedom of movement
 - > Flexible and ergonomic working in the operating room

Adviesprijs: 11 551,00

Package Deal
STUNTPRIJS 8800,00

Package DealA40613 **Implantmed Plus SI-1023** met LED+ licht+ A40683 **WS-75 L OF** A41366 **S-11 L**PROMO **3590,00**

W&H

**Piezomed SA-320**

Compleet met control unit (100-130V/220-240V),
 Variabele voetcontrole S-N1, **nieuw handstuk** met kabel van 1,8 m of 3,5 m,
 clips; irrigatie tubing set, netkabel, motorsteun, instrument wisselaar, sterilisatie cassette

+ instrument kit Bone : B1, B2R, B2L, B3, B4, B5

**Nieuw handstuk**

- Verhoogde ergonomie
- Beter hygiëne



Adviesprijs: 6845,00

PROMO A40239
 met 1,8 m kabel
5385,00

Adviesprijs: 6951,00

PROMO A40329
 met 3,5 m kabel
5485,00



W&H



Chirurgieprogramma

MASTERSurg LUX draadloos

Met de draadloze chirurgiemotor KaVo MASTERSurg LUX kunt u procedures op een ongeveend niveau uitvoeren. Onze filosofie bestaat uit u in staat te stellen elke dag uitzonderlijke prestaties te leveren, dankzij praktische functies die een groot verschil zullen maken.

A44278



Ref. 1.009.1200
4847€

Promo
4398,00

EXPERTSurg LUX

De chirurgische motor die meer precisie en kracht biedt, voor nog meer veiligheid en betrouwbaarheid. Werk veilig en met hoge precisie dankzij een van de lichtste en kleinste micromotoren ter wereld met de unieke automatische kalibratiefunctie. Vertrouw op de hoge vermogensniveaus van het 80 Ncm-koppel van het instrument, en bespaar tijd dankzij de intuïtieve programmering van uw werkstappen en parameters.

A44279



Ref. 1.008.3500
3645€

Promo
3298,00



Wereldpremière: SURGmatic™ S201 L Pro en SURGmatic™ S201 XL Pro

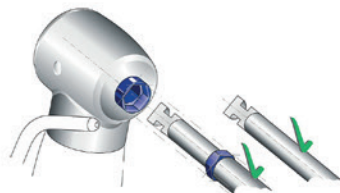

Dankzij het verbeterde klemsysteem van de S201 L Pro- en XL Pro-modellen, biedt KaVo echte vooruitgang op het gebied van gebruik. Het zeshoekige klemsysteem maakt een koppelverdeling mogelijk over een groter gebied tijdens het implantaatschroeven.



Ref. 1.013.7540
1537€
A44277

Promo
999,00

SURGmatic S201 L Pro (met kopje)



Ref. 1.013.7541
1537€
A44276

Promo
999,00

SURGmatic S201 XL Pro (met kopje)

Chirurgische handstukken INTRA



Ref. 1.009.1010
1332€
A39771

Promo
975,00

INTRA chirurgisch handstuk S11L (met licht)



Ref. 0.524.5600
1190€
A32435

Promo
899,00

INTRA chirurgisch handstuk 3610N1



Ref. 0.524.5610
1190€
A30680

Promo
899,00

INTRA chirurgisch handstuk 3610N2



Ref. 0.524.5620
1190€
A36365

Promo
899,00

INTRA chirurgisch handstuk 3610N3

PROMOTIEPAKKETTEN

- A44278 **1 MASTERSurg LUX Wireless**
- A44276 + 1 SURGmatic S201 XL Pro (met kopje)
- A45075 + 1 Steriele slangenset (10pcs)

Promo
4500,00

PROMOTIEPAKKETTEN

- A44279 **1 EXPERTSurg LUX**
- A44276 + 1 SURGmatic S201 XL Pro (met kopje)
- A45075 + 1 Steriele slangenset (10pcs)

Promo
3400,00

PG 8581 met EcoDry & PG 8591 met DryPlus

PG 8581 Thermodesinfector met warmwateraansluiting, dosering vloeibaar reinigingsmiddel & EcoDry.
Capaciteit/belading bijv. 22 hand- en hoekstukken of 22 afzuigers
Milieuvriendelijk - verwarmingspomp met variabel toerental
Veilig door controle - spoeldruk- en sproeiarmbewaking
Comfortabele ondersteuning van de droging - EcoDry
Absoluut veilig - aansluiting op procesdocumentatie mogelijk

PG 8591 Thermodesinfector met warm- & demiwateraansluiting, dosering vloeibaar reinigingsmiddel & heteluchtdroging DryPlus.
Capaciteit/belading bijv. 22 hand- en hoekstukken of 22 afzuigers
Milieuvriendelijk - verwarmingspomp met variabel toerental
Veilig door controle - spoeldruk- en sproeiarmbewaking
Efficiënte heteluchtdroging - DryPlus
Absoluut veilig - aansluiting op procesdocumentatie mogelijk

Afmetingen

hoogte: 835 mm - breedte: 600 mm - diepte: 600 mm

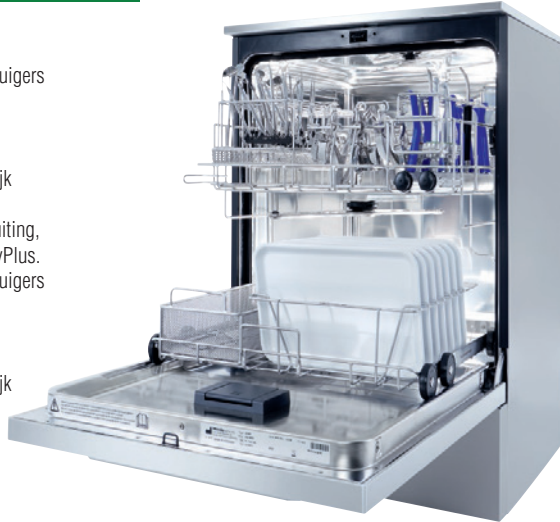

Super conditie :
GSM: **0497 44 56 22**
E-mail: **lisc@denta.be**

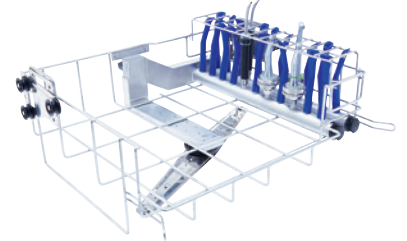

PWD8531 Tafel-thermodesinfector met interne ontharder, heteluchtdroging DryPlus en 2 doseerpompen.

A43201

Capaciteit/charge bijv. 6 hand- en hoekstukken en 6 afzuigers

Meer efficiëntie voor kleine praktijken - compact model

Efficiënte heteluchtdroging - DryPlus

Eenvoudig vloeibare media doseren - 2 geïntegreerde doseerpompen

Eenvoudige bediening - LCD-display met toetsenvrij softtouch pad

Afmetingen hoogte: 555 mm - breedte: 645 mm - diepte: 575 mm

Gewicht 55 kg

Super conditie :
GSM: **0497 44 56 22**
E-mail: **lisc@denta.be**



ProCare Dent 30 C

A37755 **neutralisatiemiddel 5 l**



Prijs
49,95

ProCare Dent 10 MA

A37754 **reinigingsmiddel 5 l**



Prijs
45,50

ProCare Universal 61

A37512 **regeneerzout 6 kg**



Prijs
28,00

ProCare Dent 40

A37756 **naspoelmiddel 1 l**



Prijs
13,90

Hydrim C61 G4

A37793 Tafelmodel
Afmetingen: h 520, b 598, d 526 mm



Adviesprijs: 6340,00

Geleverd en geplaatst !

PROMO
5490,00



Hydrim M2 G4 220 v

A32761 Bodemmodel
Afmetingen: h 830, b 600, d 600 mm



Adviesprijs: 7990,00

Geleverd en geplaatst !

PROMO
6990,00



StatMatic Smart

Geleverd zonder adaptoren



Adviesprijs: 2980,00

PROMO A40283
2 motoren
2890,00

Adviesprijs: 3150,00

PROMO A40284
3 motoren
2990,00



A37326
XL Cassette Rack, Full Size
480 x 355 x 158 mm
Adviesprijs : 154,00

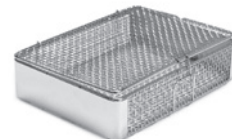

A32976
Basket/Hinged Lid, 1/4 size
156 x 216 x 54 mm
Adviesprijs : 130,00



A32281
Inzet/zeef met deksel voor boren
Adviesprijs : 74,00

Autoklaaf LARA

Afmetingen: 465 x 452 x 646 mm

Geleverd en geplaatst !

Adviesprijs: 6250,00

PROMO A42622
17 liter
4999,00

Adviesprijs: 9760,00

PROMO A42686
22 liter
5299,00



Smeerstation A41206 ASSISTINA TWIN + A37653 WG-99 LT SYNEA FUSION CONTRA-ANGLE HANDPIECE WITH LIGHT

- Verwerkt tot 360 instrumenten per uur
- Grondige uitgebreide olieservice
- Minimaal verbruik
- Kosteneffectief instrumentonderhoud
- Instrumentonderhoud in slechts 10 seconden
- Non-stop laden via twee proceskamers die afwisselend kunnen worden gebruikt
- Assistina Twin Care Set voldoende voor herverwerking tot 2800 instrumenten
- Actieve afzuiging van spuitbussen met geïntegreerde HEPA-filter
- Breed scala aan adapters



Adviesprijs: 2512,00

PACKAGE DEAL
1799,00

Autoklaaf **LISA**

- Hand- en hoekstuk cyclus; 0,5 kg in 12 minuten
- Lading van 2 kg in 30 minuten
- Gebruiksvriendelijke bediening
- Intuïtief Touchscreen
- Efficiënte Eco Dry+ functie, past droogtijd aan lading aan
- Geïntegreerde digitale documentatie van cycli
- Real Time monitoring met de Lisa Mobile App
- Trayhouder voor 5 trays of cassettes
- Aansluiting voor labelprinter en waterdemineralisatiesysteem

A42621

LISA 17 liter sterilisator

Adviesprijs: 7550,00

PROMO

5999,00

A42687

LISA 22 liter sterilisator

Adviesprijs: 8100,00

PROMO

6299,00Geleverd
en
geplaatst !

W&H

Thermodesinfector **TEON**

- Gebruiksgemak display
- Hoge reinigingsprestaties
- Zacht voor materiaal dankzij speciale programma's
- Grote keuze aan accessoires
- Reiniging van het holle lichaam
- Traceerbaarheid en connectiviteit via Ethernet-module
- Betrouwbaarheid dankzij verwarmingselementen buiten de waskamer en de naadloze kamer

A42961 **TEON**

Adviesprijs: 6240,00

PROMO

5499,00A42962 **TEON+**

Active air-drying with HEPA filter

Adviesprijs: 9570,00

PROMO

8990,00Geleverd
en
geplaatst !

W&H



Adviesprijs: 5200,00

STUNTPRIJS
A42042 18 liter**3999,00**

Adviesprijs: 5999,00

STUNTPRIJS
A42123 23 liter**4999,00**

Afmetingen: 493 x 484 x 630 mm

Geleverd en geplaatst !

AUTOCLAVE SERIE NISEA

18 AND 23 VERSION | CLASS B CYCLES

- Snelle Klasse B 'Flash Cycle' voor kleine ladingen
- Geïntegreerde digitale documentatie van cycli
- Gemotoriseerd openen en sluiten van de deur
- Intuïtief 5" HD touchscreen bedieningspaneel
- Automatische waterkwaliteit controle
- Optioneel uit te rusten (label) printer en Wi-Fi module



FARO STERILIZATION LINE

Full line of products covering every step of the sterilisation cycle.

Find out more www.faro.it

EXPERIENCE AND INNOVATION
SINCE 1948

CS 8200 3D uitgebreide mogelijkheden in een klein pakket

Veelzijdig 2D / 3D-systeem,
ideaal voor het uitbreiden van behandelingsmogelijkheden.
Uitgebreid gezichtsveld - tot 12 cm x 10 cm -
het beste voor volledige boogscans.
Uitstekende 2D / 3D-beelden dankzij
de nieuwste premium technologie.
3D-afbeeldingen met hoge resolutie met
beperkte artefacten en ruis.
State-of-the-art 2D / 3D-software voor
eenvoudige beeldcontrole.
Geïntegreerde oplossingen stroomlijnen
de workflow en helpen de patiënt
binnenshuis te houden.



Voor verdere informatie en scherpe prijzen :

Lionel Schijns
GSM: 0497 44 56 22
lisc@denta.be

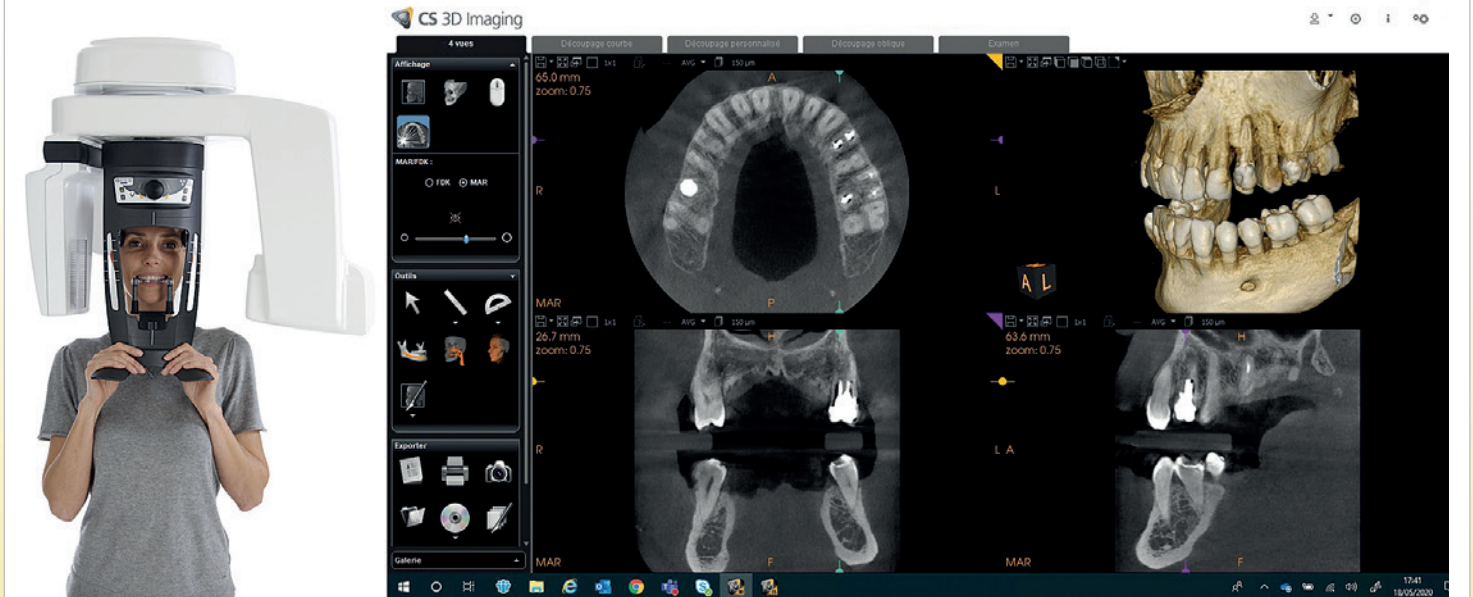

MICROSCOPEN **LABOMED**

Prima Mj

De perfecte mix voorzien van een sterke
Led lichtbron en een perfect afgestelde
mechaniek.
De compacte prima mj levert 100%
betrouwbaarheid.

VANAF
6 740,00
Geleverd en geplaatst



Prima

Prestatiegericht, flexibel met een uitstekende prijs/kwaliteit-
verhouding voor diagnostisch en chirurgisch gebruik.



VANAF
8 650,00
Geleverd en geplaatst

Magna de kracht van de zoom

De Labomed Magna microscoop is bijzonder voor-
uitstrevend door zijn 'Automatic Balance Arm' (ABA).
Dit is een elektromagnetisch remsysteem dat met de
bediening van slechts één knop de hele kop van de
microscoop van kijkhoek en positie kan veranderen.
Dankzij het eenvoudige en snelle ABA remsysteem
kan de tandarts de Magna microscoop met één hand
eenvoudig herpositioneren.
Daarnaast zorgt het traploze zoom- en vergroting
systeem voor een enorm bereik in vergroting.

VANAF
19 750,00
Geleverd en geplaatst



We help make
dental implant
treatments more predictable



A43917 OMNIA
Barrier sleeves Osstell Beacon
100 stuks

Prijs
95,00

Voor verdere informatie en prijzen:
03 450 93 20 of marketing@denta.be

Let ISQ Guide You

De Osstell Beacon+, de objectieve manier om de stabiliteit van implantaten te meten. Dit toestel helpt u om te beslissen wanneer u het implantaat kunt gaan belasten. Als u de zekerheid van uw behandelingen wilt verhogen is de Osstell Beacon+ een ideaal hulpmiddel.



Manage patients with risk factors

Avoid unnecessarily long treatment times

Achieve more predictable outcomes

OSSTELL
A LIGHT COMPANY

VERLICHTING

ALYA 2.0

Verschillende bevestigingsmogelijkheden

- Power consumption max 26 VA
- Color Temperature 5.000 K
- Lux from 3.000 to 50.000 (at 700 mm distance)
- Light spot dimension 205 x 100 mm (at 700 mm distance)
- Cooling System static heat sink (no fan required)
- CRI : 97



Vanaf
1800,00

DR. MACH

- Keuze uit:
- Dr. Mach LED₂
- Dr. Mach LED₃
- Dr. Mach Videosystemen
- Dr. Mach 130F en 130

Vanaf
1490,00

Dr. Mach



Voor verdere informatie en prijzen :
Lionel Schijns
GSM: 0497 44 56 22
lisc@denta.be

www.denta.be : **10% korting**

op Perma Sharp hecht draad !

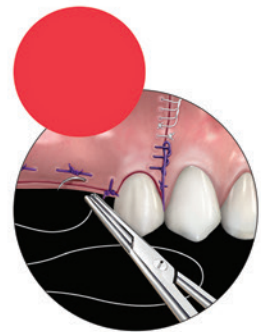

			NON-ABSORBABLE				ABSORBABLE			
NEEDLE		SUTURE SIZE	SILK, BLACK BRAIDED	POLYESTER, GREEN BRAIDED	POLYPROPYLENE	BLACK MONOFILAMENT NYLON	PGA VIOLET-DYED BRAIDED*	PGA-UNDYED BRAIDED*	PGA FA UNDYED BRAIDED* (FAST ABSORPTION)	
PREMIUM CUT										
C-1		3/8 Circle Premium Reverse Cut	10.7 mm	3-0						
				4-0						
				5-0					PSN490V	
				6-0			PSN8697P		PSN489V	
				7-0			PSN8696P			
C-3		3/8 Circle Premium Reverse Cut	13 mm	3-0						
				4-0	PSN641S				PSN494V	PSN510FA
				5-0	PSN640S	PSNR698L	PSN8698P	PSN698N	PSN493V	PSN515FA
				6-0			PSN8695P		PSN492V	
				7-0						
C-6		3/8 Circle Premium Reverse Cut	18.7 mm	3-0						
				4-0					PSN525FA	
				5-0					PSN530FA ¹	
				6-0						
				7-0						
REGULAR CUT										
C-6		3/8 Circle Reverse Cut	18.7 mm	3-0	PSN772S	PSNR772L		PSN393V	PSN540FA	
				4-0	PSN683S	PSNR683L	PSN8683P	PSN662N	PSN392V ¹	PSN535FA
				5-0	PSN682S		PSN8661P	PSN661N	PSN422V ¹	PSN421V ¹
				6-0						
				7-0						
C-4		1/2 Circle Reverse Cut	12.7 mm	3-0						
				4-0						
				5-0			PSN8245P			
				6-0						
				7-0						
C-7		3/8 Circle Reverse Cut	24.3 mm	3-0	PSN684S					
				4-0						
				5-0						
				6-0						
				7-0						
C-9		1/2 Circle Reverse Cut	23 mm	2-0	PSN737S					
				3-0	PSN632S			PSM460V ¹	PSN585FA	
				4-0	PSN631S					
				5-0						
				6-0						
C-17		3/8 Circle Reverse Cut	12 mm	3-0						
				4-0	PSN736S				PSN386V	
				5-0	PSN719S		PSN8385P		PSN385V	
				6-0			PSN8384P			
				7-0						
C-19		1/2 Circle Reverse Cut	18.3 mm	3-0	PSN733S					
				4-0	PSN734S				PSN724V	
				5-0					PSN723V	
				6-0						
				7-0						
C-22		3/8 Circle Reverse Cut	16.2 mm	3-0				PSN389V		
				4-0						
				5-0	PSN1628S		PSN8614P		PSN388V	
				6-0	PSN681S		PSN8660P		PSN387V	
				7-0						
C-43		1/2 Circle Reverse Cut	16.2 mm	3-0	PSN7762S					
				4-0	PSN7763S					
				5-0	PSN7764S					
				6-0						
				7-0						
D-14		1/2 Circle Cutting End Taper	17.5 mm	3-0	PSN953S ¹	PSN6953L ¹				
				4-0	PSN952S ¹			PSN271V ¹		
				5-0			PSN7773L	PSN7773P		
				6-0						
				7-0						
T-28		1/2 Circle Taper Point	17.5 mm	3-0	PSN872S ¹					
				4-0	PSN871S				PSN304V	
				5-0	PSN870S		PSN8756P		PSN303V ¹	
				6-0					PSN302V ¹	
				7-0						
T-4		1/2 Circle Taper Point	22.2 mm	2-0						
				3-0	PSN7343S ¹					
				4-0	PSN7342S ¹					
				5-0						
				6-0						

Sutures are 18" in length unless otherwise noted.

† 27" in length.

* PGA loses strength in 14-17 days and is absorbed in 90-120 days.

■ PGA FA loses strength in 14-17 days and is absorbed in 49-63 days.

1 Also available in 27" length (PSN397V).

2 Also available in 27" length (PSNH821A).

A13497
NHCW
Promo
34,50



A14045
NH5038
Promo
119,00



A43248
NH4024 CORT
Promo
349,00



NEEDLE HOLDER (CORTELLINI) MICRO CASTROVIEJO STRAIGHT 15 cm
Adviesprijs: 426,85

TUNGSTEN CARBIDE SURGICAL CUTTERS

SURGERY



HM 151 V32369



Fig.	Schaft / Shank	Ref.-Nr. / Ref.-No.	2
		L mm	10,8
HM 151	FG XL	500 316 199 295	016
HM 151	FG XXL	500 317 199 295	016



HM 161 V06085



Fig.	Schaft / Shank	Ref.-Nr. / Ref.-No.	2
		L mm	11,0
HM 161	HP	500 104 408 295	018
	RA L	500 205 408 295	018
	FG XL	500 316 408 295	018



HM 162 V06235



Fig.	Schaft / Shank	Ref.-Nr. / Ref.-No.	2
		L mm	11,0
HM 162	HP	500 104 408 297	016
	RA L	500 205 408 297	016
	RA XL	500 206 408 297	016
	FG XL	500 316 408 297	016



TUNGSTEN CARBIDE SURGICAL ROUND DRILLS

5% korting

HM 166 V06088



Fig.	Schaft / Shank	Ref.-Nr. / Ref.-No.	2
		L mm	11,0
HM 166	HP	500 104 409 297	021
	RA L	500 205 409 297	021



HM 141 V06313

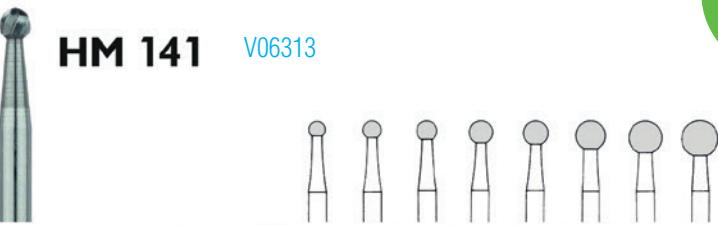



Fig.	Schaft / Shank	Ref.-Nr. / Ref.-No.	2	2	2	2	2	2	2	2	2
HM 141	HP	500 104 001 291	023	025	027	031	035	040	045	050	
	RA L	500 205 001 291	023								



Hartmetall, 6 Schneiden | Tungsten carbide, 6 blades | Carbuo, 6 laminas

STEEL SURGICAL CUTTERS

161 Stahl / steel A05220





Fig.	Schaft / Shank	Ref.-Nr. / Ref.-No.	2
		L mm	9,0
161	FG XL	310 316 408 295	016



162 Stahl / steel V05222
162RF Edelstahl / stainless steel





Fig.	Schaft / Shank	Ref.-Nr. / Ref.-No.	2
		L mm	9,0
162	RA L	310 205 408 297	016
	FG XL	310 316 408 297	016
162RF	HP	330 104 408 297	016
	RA L	330 205 408 297	016
	FG XL	330 316 408 297	016



163RF Edelstahl / stainless steel A05759





Fig.	Schaft / Shank	Ref.-Nr. / Ref.-No.	2
		L mm	5,0
163RF	HP	330 104 406 297	014



164RF Edelstahl / stainless steel A05357



Fig.	Schaft / Shank	Ref.-Nr. / Ref.-No.	2
		L mm	6,0
164RF	HP	330 104 407 297	018



165RF Edelstahl / stainless steel V05225



Fig.	Schaft / Shank	Ref.-Nr. / Ref.-No.	2
		L mm	7,0
165RF	HP	330 104 408 297	023
	RA L	330 205 408 297	023



166 Stahl / steel V05226
166RF Edelstahl / stainless steel





Fig.	Schaft / Shank	Ref.-Nr. / Ref.-No.	2
		L mm	10,0
166	RA L	310 205 409 297	021
166RF	HP	330 104 409 297	021



STEEL SURGICAL CUTTERS

SURGERY 

5%
korting



167RF Edeltahl / stainless steel A05363

Fig.	Schaft / Shank	Ref.-Nr. / Ref.-No.		2
			L mm	10,0
167RF	HP	330 104 410 297		023



168 Stahl / steel
168RF Edeltahl / stainless steel

Fig.	Schaft / Shank	Ref.-Nr. / Ref.-No.		1
			L mm	22,0
168	HP L	310 105 411 297		023
168RF	HP L	330 105 411 297		023

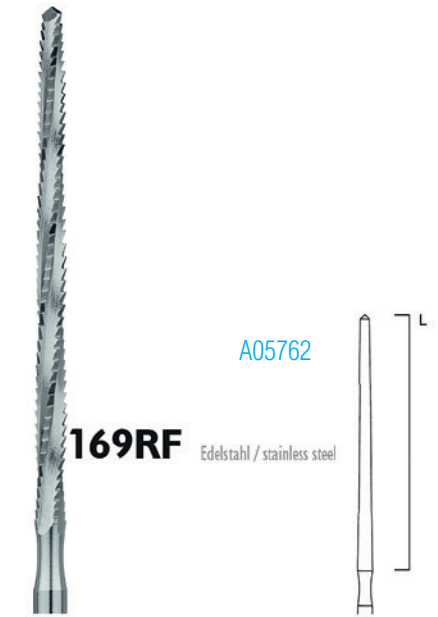

169RF Edeltahl / stainless steel A05762

Fig.	Schaft / Shank	Ref.-Nr. / Ref.-No.		1
			L mm	35,0
169RF	HP XL	330 106 412 297		023



DIAMOND COATED SURGICAL INSTRUMENTS

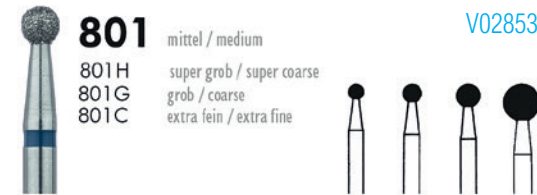

801 mittel / medium V02853
801H super grob / super coarse
801G grob / coarse
801C extra fein / extra fine

Fig.	Schaft / Shank	Ref.-Nr. / Ref.-No.		5	5	5	2
801	HP	806 104 001 524		023	027	033	050
801H	HP	806 104 001 544					050
801G	HP	806 104 001 534		023		033	050
801C	HP	806 104 001 504		023			



Sinus Präparation | Sinus preparation | Preparacion del seno



231DC extra fein / extra fine V39956

Fig.	Schaft / Shank	Ref.-Nr. / Ref.-No.		1	1	1
			L mm	0,3	0,3	0,3
231DC	HP	806 104 064 504		070	100	
	RA	806 204 064 504		070*	100*	130*



Osteotomie-Säge für Chirurgie | Osteotomy saw for surgery | Sierra de osteotomia para cirugía

* in Saw Basic Kit 7150 enthalten * contained in the Saw Basic Kit 7150 * figuran en el Saw Basic Kit 7150

Stainless Steel Twist Drills



203RF Edeltahl / stainless steel V30151

Fig.	Schaft / Shank	Ref.-Nr. / Ref.-No.		2	2
			L mm	7,0	7,0
203RF	RA L	330 205 417 364		006	008



! According to Dr. Istvan Urban

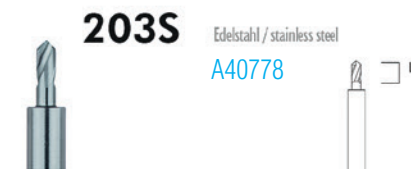

203S Edeltahl / stainless steel A40778

Fig.	Schaft / Shank	Ref.-Nr. / Ref.-No.		2
			L mm	3,0
203S	RA	330 204 449 336		012

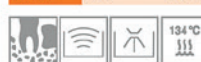

Spiralbohrer mit Stop zur Dekortikalisierung | Twist Drill with Stop for decorticating | Taladros espirales con tope para corticotomía





Master-Pin-Control

34x Pins

Pin System for Membrane Fixation | developed with Dr. Istvan Urban

Master-Pin-Control is designed especially for the fixation of resorbable, non-resorbable and titanium reinforced membranes. Since the pins have an extra mini-thread, they are a hybrid between a screw and a pin. The thread increases the surface of the pins and thus offers much more stability. In addition, due to the thread and a unique head-design, the pins can be removed easily and safely which is especially important after a successful healing period. With their sharp tip and very stable shank, they can be inserted easily and precisely into dense cortical bone.



A43341
Art.-No. BMP00
Prijs : 1188,60

Download de volledige brochure :

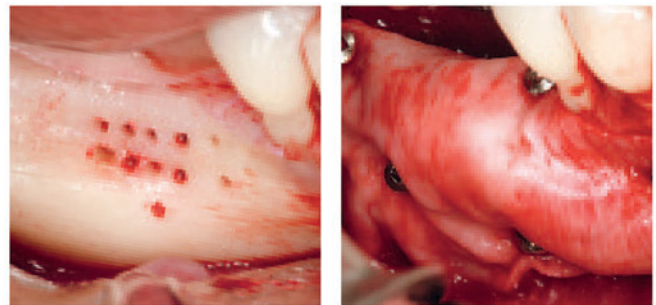

© Dr. Istvan Urban

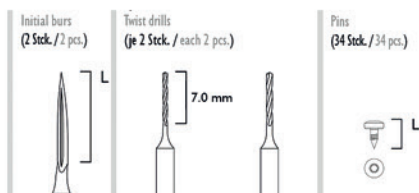

Fig.	186RF	203RF	203RF	MP10*
Shank ¹	204	205	205	-
Size ²	018	006	008	-
Length mm	12.0	7.0	7.0	3.65
Δ	-	-	-	0.87
+L	1.8	0.6	0.8	0.95

¹ 204=RA, 205=RA L ² Largest working part diameter in 1/10 mm
Δ Minimaldurchmesser Minimal diameter +L Außendurchmesser External diameter

* Bei Wiederverwendung von Einmalprodukten kann ein Infektionsrisiko nicht ausgeschlossen werden und eine risikofreie Funktionssicherheit nicht gewährleistet werden. With the reuse of disposable products, the risk of infection cannot be excluded and a risk-free functional safety cannot be guaranteed.

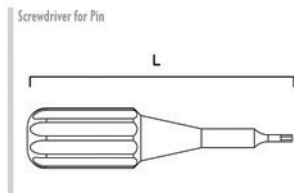

Fig. MP11
illustrated 1:1 (Length mm: 35.0)



Fig. MP12
illustrated 1:2 (Length mm: 170.0)



Fig. MP14
illustrated 1:2 (Length mm: 165.0)



Master-Pin-Control Basic

Also available with 10 pins.

10x Pins A42114 Art.-No. BMPBA Prijs : 838,60

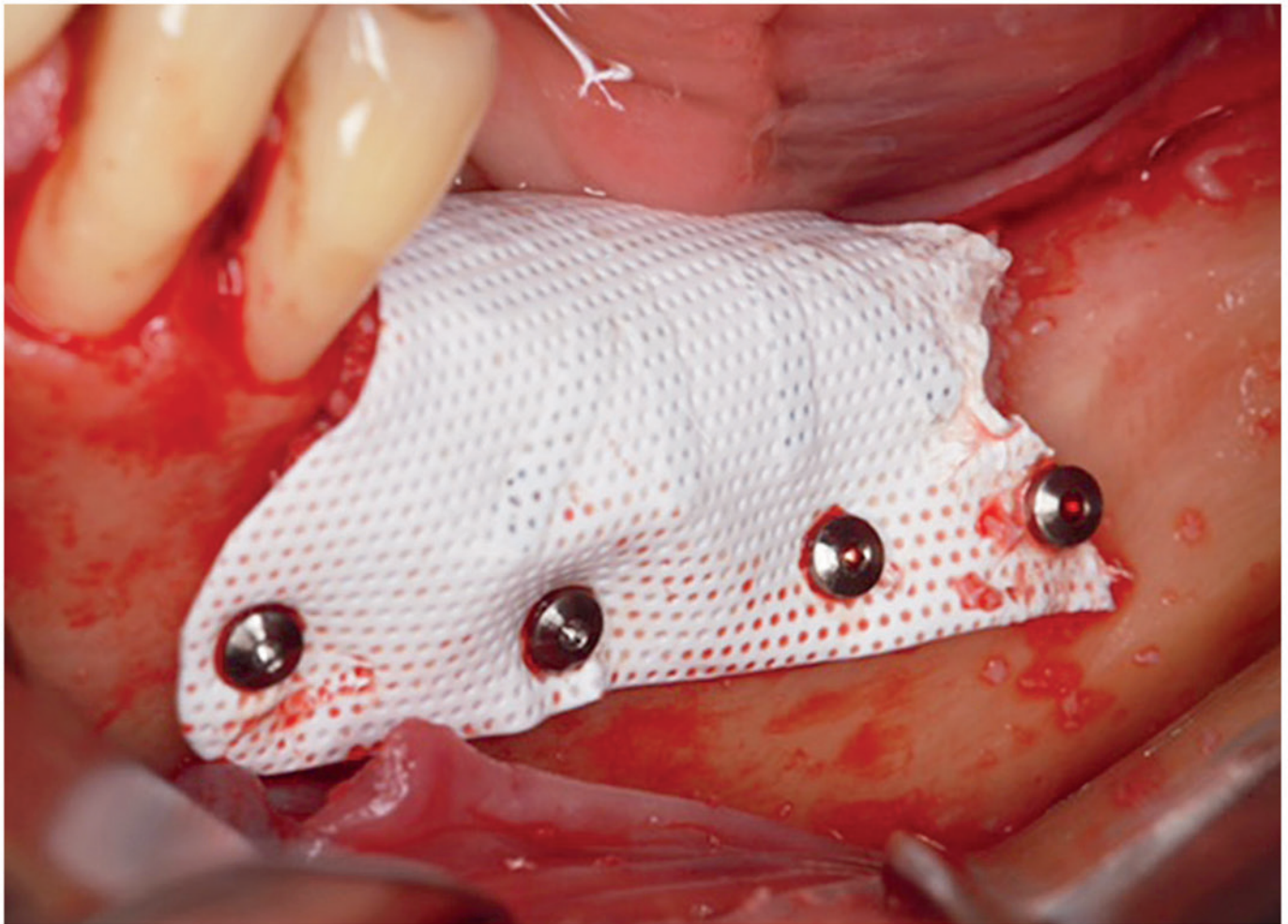

Optionally available:

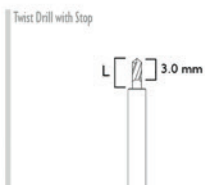

Fig.	203S
Shank ¹	204
Size ²	012
Length mm	4.0
Δ	-
+ □ +	1.2

¹ 204=RA ² Largest working part diameter in 1/10 mm



Fig.	MP 15
illustrated 1:2 (Length mm: 148.0)	

* Bei Wiederverwendung von Einmalprodukten kann ein Infektionsrisiko nicht ausgeschlossen werden und eine risikofreie Funktionssicherheit nicht gewährleistet werden. With the reuse of disposable products, the risk of infection cannot be excluded and a risk-free functional safety cannot be guaranteed.



URBAN
REGENERATION INSTITUTE

Urban Regeneration Institute
www.implant.hu

Developed with
Dr. Istvan Urban
Budapest, Hungary



BONE MANAGEMENT® CATALOGUE

Augmentation with precision...

...with the MEISINGER Bone Management® Systems. *Quality that convinces*

The in cooperation with leading scientists and practitioners developed product line MEISINGER Bone Management® offers perfectly harmonized system solutions for the controlled optimization of the bony implant site – completely independent of the used implant system. Besides prosthetic aspects, the minimally invasive character of the surgical intervention in complicated indications plays an important role in this product line. Clearly structured and standardized procedures offer the possibility of an implant restoration to a greater number of surgeons. Due to controlled and gentle bone preparation, Bone Management® is a key factor for long-term success in oral implantology.

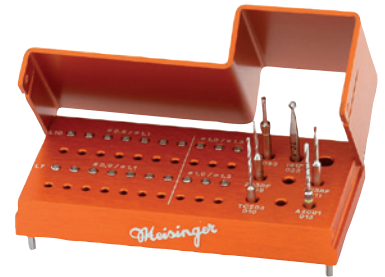

Download de volledige brochure :



www.meisinger.de

IRRIGATIESET 1/2Y (10 stuks) Omnia

A41722 **Compatibel met:** Nouvag 3000/ Nouvag7000/ MD10, MD 11, MD20 without tap, MD30/ Straumann model Nouvag/ SM12 Sem2/ SU100/ CBM; Nouvag 8000 with tap, MD10S, MD20 with tap



Prijs : 77,00

Per 10 / stuk : 59,50

IRRIGATIESET 1/2Y (10 stuks) Omnia

A42457 **Compatibel met:** NSK Surgic XT, Surgic XT Plus, Osseocision, VarioSurg, SurgicPro, Kyocera Implantor Neo, Bonart Piezo surgical system, Dentium iCTmotor, NSK 3i Osseocision, Delfine Intra-Lock



Prijs : 77,00

Per 10 / stuk : 59,50

IRRIGATIESET 1/2Y (10 stuks) Omnia

A38940 **Compatibel met:** Nobel Biocare80/ W&H Implantmed/ Implant Med new design 2005/ Implantmed SI 923/ Astratech Implant SI 923/ Surgical Motor System/Ace/ Straumann/InnovaCorp. 3I/Centerpulse/Lifecore/ DU 900/ FRIOS UNIT S/ FRIOS UNIT S/I, Osseoset 100/Osseoset 200/Osseocare, Elcomed SA 310/SA2006, Piezomed

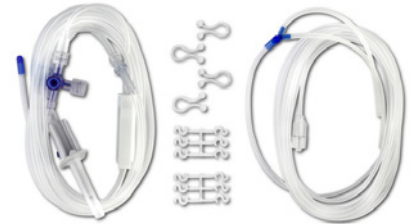

Prijs : 77,00

Per 10 / stuk : 59,50

IRRIGATIESET 1/2Y (10 stuks) Omnia

A41393 **Compatibel met:** W&H Elcomed 200/100, Astratech Elcomed 100

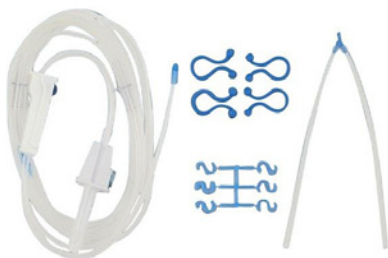

Prijs : 77,00

Per 10 / stuk : 59,50

IRRIGATIESET 1/2Y (10 stuks) Omnia

A42352 **Compatibel met:** Nobel Biocare80/ W&H Implantmed/ Implant Med new design 2005/ Implantmed SI 923/ Astratech Implant SI 923/ Surgical Motor System/Ace/ Strauman/ InnovaCorp. 3I/Centerpulse/Lifecore/ DU 900/ FRIOS UNIT S/ FRIOS UNIT S/I, Drilltech/Osseoset 100/ Osseoset 200/Osseocare



Prijs : 110,00

Per 10 / stuk : 76,50

IRRIGATIESET 1/2Y (10 stuks) Omnia

A46174 **Compatibel met:** Bien Air Chiropro 980/EMS PIEZONMASTER surgery/Esacrom Surgisonic 1/UBS- Ultrasonic bone surgery/Surgybone - Acrobone - Easybone, Silfradent, BioSAFIN Easy Surgery, MyTUTOR, Heracle Sweden&Martina,Cefla dental Chair, Osseodoc BienAir, 1/2Y



Prijs : 77,00

Per 10 / stuk : 59,50

IRRIGATIESET 1/2Y (10 stuks) Omnia

A46173 **Compatibel met:** Acteon Implant centre, Piezotome; Dual 2000 De Godzen; Assitant Novaxa, Suni Satelec Expert, Acteon I-Surge, I-Surge Plus, Acteon Piezotome/Piezotome 2, Acteon Solo, Acteon Implant center/ Implant center2 Led, 1/2Y



Prijs : 105,00

Per 10 / stuk : 74,80

IRRIGATIESET UNIVERSEEL (10 stuks) Acteon

A32384 **Compatibel met:** Acteon Piezotome CUBE, Implant Center 2, Piezotome, Piezotome 2, Piezotome Solo en Implant Center



Prijs : 156,90

Per 10 / stuk : 102,00

IRRIGATIESET WEGWERP 2,2 M (10 stuks) W&H

A33044 **met 1,8 m kabel**
Compatibel met: W&H Elcomed SA-200

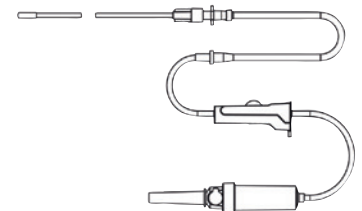

Prijs : 55,70

Per 10 / stuk : 42,50

IRRIGATIESET WEGWERP 2,2 M (10 stuks) W&H

A33800 **met 1,8 m kabel**
Compatibel met: W&H Implantmed SI-1023, Implantmed SI-1015 en Piezomed SA-320

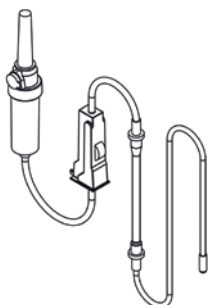

Prijs : 55,70

Per 10 / stuk : 42,50

IRRIGATIESET WEGWERP 3,8 M (10 stuks) W&H

A35457 **met 3,5 m kabel**
Compatibel met: W&H Implantmed SI-1023, Implantmed SI-1015 en Piezomed SA-320

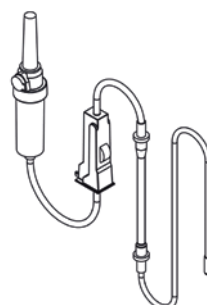

Prijs : 65,80

Per 10 / stuk : 49,30

IRRIGATIESET WEGWERP 3,8 M (10 stuks) W&H

A31442 **met 3,5 m kabel**
Compatibel met: W&H Elcomed SA-200

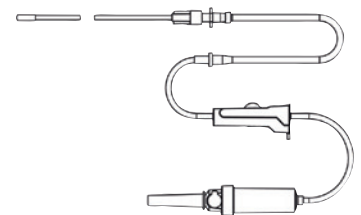

Prijs : 65,80

Per 10 / stuk : 49,30

IRRIGATIESET (10 stuks) Bien Air

A40214 **Compatibel met:** Bien Air Chiropro en iChiropro



Prijs : 107,39

Per 10 / stuk : 73,95

IRRIGATIESET S600 (10 stuks) KaVo

A45075 **Compatibel met:** Kavo MASTERSurg en EXPERTSurg



Prijs : 99,00

Per 10 / stuk : 69,70

DISPOSABLE STERILE SPONGE-BRUSH Omnia

A41949 With nail pick

25 stuks



Prijs : 27,00

Per 4 / stuk : 22,50

IRRIGATIESET WEGWERP 2,2 M (10 stuks) W&H

A32027 **met 1,8 m kabel**

Compatibel met: W&H Implantmed SI-1023, Implantmed SI-1015 en Piezomed SA-320



Prijs : 37,10

Per 10 / stuk : 29,75

IRRIGATIESET WEGWERP 3,8 M (10 stuks) W&H

A27052 **met 3,5 m kabel**

Compatibel met: W&H Implantmed SI-1023, Implantmed SI-1015 en Piezomed SA-320



Prijs : 44,20

Per 10 / stuk : 35,70

UNISEX BREATHABLE CAP LIGHT BLUE Omnia

A45214

100 stuks



Prijs : 69,00

Per 5 / stuk : 54,40

DENTSET Omnia

A46169 Steriele set bestaande uit afdekdokken voor de patiënt en oppervlakken. Daartoe behoren ook hoezen voor handstukken en zelfklevende folies voor handgrepen en toetsenborden. De set is dubbel verpakt. Het handige verwijderbare etiket vergemakkelijkt de vervolgbaarheid van de procedure.

Inhoud:

- 1 x Absorberend/vloeistofbestendig afdeklaken 100 x 150 cm met U-vormige uitsparing 6,5 x 30 cm - NWF + PE - Lichtblauw
- 1 x Absorberende/waterbestendige afdeeldoek 75 x 90 cm - NWF + PE - Lichtblauw
- 2 x Absorberende/waterbestendige afdeeldoek 50 x 75 cm - NWF + PE - Lichtblauw
- 2 x Omnisleeve hoezen 120 x 7 cm - PE - Transparant
- 4 x 2Cross20 zelfklevende folies 20 x 20 cm - LDPE - Lichtblauw



Prijs : 18,00

Per 10 / stuk : 14,45

Per 20 / stuk : 13,60

Per 100 / stuk : 12,75

CHIRURGENSET Omnia

A46168 Deze steriele kledingset is ontworpen voor de chirurg. De set is ideaal voor alle tandheelkundige implantaties, parodontologie en maxillofaciale ingrepen. De set wordt geleverd in een dubbele steriele verpakking, gewikkeld in medisch papier. Het handige verwijderbare etiket vergemakkelijkt de vervolgbaarheid van de procedure.

Inhoud:

- 1 x Chirurgisch gevouwen Expo-model jas (maat L) en
- 2 handdoeken gewikkeld in medisch papier - Softesse - Lichtblauw
- 1 x Operatiemuts met verstelbare koorden - NWF - Lichtblauw
- 1 x SPIRITUS PLUS® gelaatsmasker met koorden - NWF - Lichtblauw
- 2 x Antislip schoenbeschermers - NWF - Lichtblauw



Prijs : 13,00

Per 10 / stuk : 10,20

Per 20 / stuk : 9,35

Per 100 / stuk : 8,50

BASIC IMPLANT SET Omnia

- A42458
 1 x Surgically folded Special Plus model gown (size L) and 2 hand towels wrapped in medical paper - SMS Microfibre - Light blue
 1 x Gown with cotton cuffs - NWF - Light blue
 2 x Surgical caps with fixed laces - Absorbent NWF - Light blue
 1 x Round surgical cap for the patient - Absorbent NWF - Light blue
 1 x Absorbent/liquid proof drape 50 x 75 cm with self-adhesive* side - NWF + Polyethylene - Light blue
 1 x Absorbent/liquid proof drape 75 x 90 cm with adhesive* U-shaped cut 11 x 9 cm - NWF + Polyethylene - Light blue
 1 x Omnisleeve sheath 120 x 7 cm - PE - Transparent
 1 x Waste bag for contaminated material - PVC - Red



Prijs : 22,00 **Per 10 /stuk : 17,00 Per 20 /stuk : 16,16 Per 100 /stuk : 15,30**

IMPLANTOLOGY SET Omnia

- A41869
 2 x Surgically folded Special Plus model gowns (size L) and hand towel wrapped in medical paper - SMS Microfibre - Light blue
 2 x Liquid proof/absorbent drapes with self-adhesive* side 75 x 90 cm - NWF + Polyethylene - Light blue
 1 x Surgical aspirator with Yankauer tip - PVC - Transparent
 1 x Liquid proof/absorbent drape 100 x 150 cm with adhesive* U-shaped cut 6,5 x 30 cm - NWF + Polyethylene - Light blue
 1 x Omnisleeve sheath 120 x 7 cm - PE - Transparent
 2 x 2Cross20 adhesive films 20 x 20 cm - LDPE - Light blue
 1 x Waste bag for contaminated material - PVC - Red



Prijs : 39,00 **Per 10 /stuk : 32,30 Per 20 /stuk : 29,75 Per 50 /stuk : 27,20**

ORAL SURGERY SET Omnia

- A44314
 2 x Surgical gowns Expo (size L) surgically folded and 2 hand towels wrapped in medical paper - Softesse - Light blue
 1 x Breathable cap - NWF - Light blue
 2 x Liquid proof/absorbent drapes 75 x 90 cm with self-adhesive* side - NWF + Polyethylene - Light blue
 1 x Mayo table cover 80 x 120 cm - NWF + PVC - Light blue
 1 x Cover in transparent PVC 40 x 50 cm with self-adhesive* side - PVC - Transparent
 2 x Omnisleeve sheaths 240 x 7 cm - PE - Transparent
 1 x ASP51/F surgical aspirator - PVC - Transparent
 2 x 2Cross20 adhesive films 20 x 20 cm - LDPE - Light blue
 1 x Sponge with grip for patient disinfection - PVC - Blue
 1 x Bowl 250 ml - PVC - Blue
 1 x Fluid-repellent drape 133 x 200 cm with adhesive* off-center hole 6 x 9 cm Softesse Light blue 5
 1 x Round cotton balls Ø 3 cm - Cotton - White
 1 x Waste bag for contaminated material - PVC - Red



Prijs : 63,00 **Per 10 /stuk : 51,00 Per 20 /stuk : 49,30 Per 50 /stuk : 46,75**

GOWN WITH COTTON CUFFS NON-STERILE BLUE Omnia

A45440 **50 stuks**, 110 cm



Per 5 /stuk : 69,70 Prijs : 105,00

Irrigatieoplossing met steriel gedestilleerd water Omnia

A46170 **10 x 1 liter**



Prijs : 35,00

Per 5 / stuk : 29,70

A46171 **15 x 500 ml**



Prijs : 38,00

Per 5 / stuk : 31,50

A46172 **20 x 250 ml**



Prijs : 42,00

Per 5 / stuk : 34,20

www.denta.be

eenvoudig bestellen aan uw prijs !

NIEUW De staffelkorting !

Ontdek meteen uw staffelkorting bij aankoop van meerdere items uit een reeks. Zo stelt u zelf de ideale kleurenmix samen van uw vertrouwde composiet en geniet u automatisch van de beste staffelprijs in uw winkelmand.

ZOEKEN OP 'QUADRANT UNIVERSAL LC SPUIT'

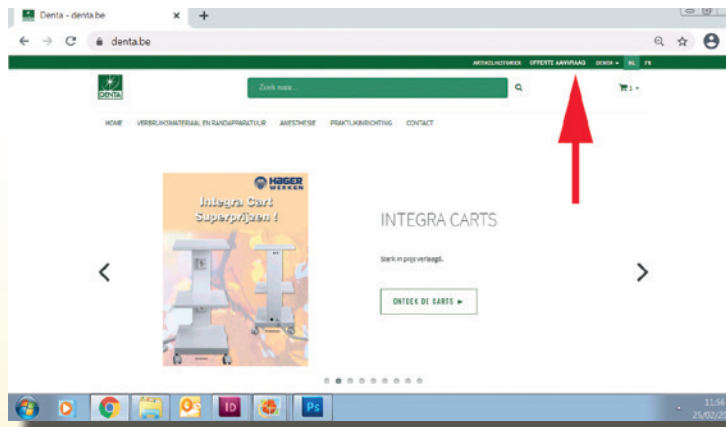
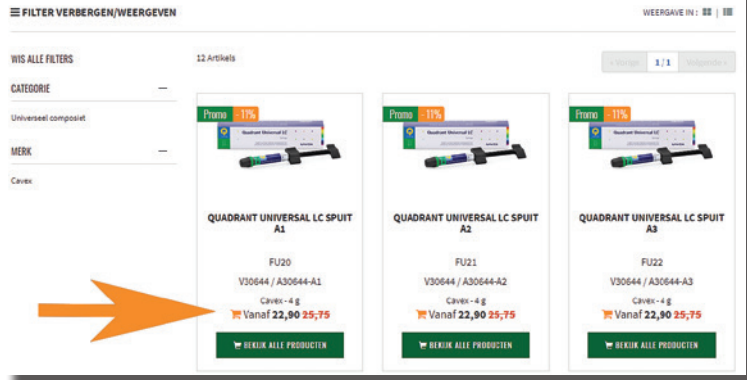

NIEUW Offertes !

Wenst u een **offerte** voor een **apparaat** of **grote afnames** (composieten, endo vijlen, cementen...) kan u steeds terecht op het document van de **"Offerte aanvraag"**. Denta geeft u de beste prijs !



GEZICHTSMASKERS VOOR MEDISCHE PROCEDURES - EN14683 TYPE IIR STANDAARD CROSSTEX

Met aan de binnen- en buitenkant een vloeistofbestendige laag voor optimale bescherming tegen vloeistoffen; voorzien van een extra lange aluminium neusbeugel die de neus en jukbeenderen goed afsluit.

De platte, elastieken oorlussen verminderen de druk op de oren en zitten vast aan de buitenzijde van het masker. Dit voorkomt huidirritatie en biedt optimaal draagcomfort.

GCPBLEU

Gezichtsmaskers voor medische procedures - EN14683 Type IIR Standaard lichtblauw, doos van 50 stuks



A46175

Adviesprijs

14,50 €

Promo per stuk

9,50

Promo per 5 / stuk

8,55

GEMAAKT
IN EUROPE

Recupel-bijdrage: 0,10. Prijzen zijn in euro exclusief btw en per stuk of verkoopseenheid. Druk- en zetfouten voorbehouden. Foto's zijn niet bindend. Bij bestellingen boven de 150 euro exclusief btw worden geen administratie - en verzendkosten aangerekend. Promoties geldig van **01/06/2021** tot **31/08/2021** en zolang de voorraad strekt. Acties niet cumuleerbaar met andere promoties.

Denta nv, Heiveldekens 2, 2550 Kontich, www.denta.be

