



Polo

Designed around you

Your work is a long and patient journey, a precise sequence of gestures that combine cutting-edge technology and human sensitivity and, as such, it requires control, order, and precision. Dental Art has created POLO with the same patience and the same combination of science and passion. POLO is the new laboratory workstation whose every detail is designed to ensure a comfortable working experience, even during the longest sessions. Elegant, functional, and precision assembled using the finest materials: such qualities are already evident in the individual units but the system really comes into its own with the countless configurations offered by a remarkable modular design that, with the option of a personalised colour scheme or the standard black and white, can adapt to suit any style, environment and working routine. The new POLO lab brings together all of the values that have set Dental Art apart from the beginning. Let's find out more.



One station bench with Aleva lighting unit (T0+LAMPTR), Fenix NTM® "Nero Ingo" working top (RF720) and housing (TCB) for micromotor arrangement.

One station bench with Aleva lighting unit (T0_C+LAMPTR), retractable arm rests (TBR), lower furnace module (PL3), Fenix NTM® "Grigio Londra" and "Nero Ingo" worktops "(RF718+RF720)

One station bench with 5 drawers and Aleva lighting unit (T1+LAMPTR), retractable arm rests (TBR), housing for screen (X10ML), laminate worktop (X5L), DUSTINET II suction unit (ASPT)





Double effectiveness

The same features of the single modules, in terms of materials, functions, and colour customisation, can be found also in the double workstation. A solution that can be configured with a double suction system or with a single one featuring a press-fit compartment based on your specific requirements. And you can choose which accessories to use. Because POLO is the answer to all your questions.

Two station bench equipped with 10 drawers and housing with door, 2 Aleva lighting units (T2+TCA+LAMPTR) with integrated shelf (JRT+2xST), arm rests (TBRG), Fenix NTM® "Nero Ingo" worktop (RF720), Dustinet II suction unit (ASPT). Colour PANTONE 424C



The shape of light

Alevas was a great ancient Greek sculptor. Aleva is the name we have chosen for the lamp that makes POLO stand out. This lamp is made from a single sheet of metal bent with extreme precision, without welds, and features a sophisticated, contemporary design. It's almost a work of art in line with the extraordinary ability and gestures it accompanies, thanks to the LED intensity adjustment. Beautiful, useful, and customisable: you can choose the colour of the power cable sheath from the 6 available, and the power button plate can come with a USB port so you can charge your smartphone or tablet. Aleva gives shape to light and puts it at the service of your everyday work.



Two gestures at your fingertips

The corner module is designed to allow the operator to manage two types of work: those that require the use of suction and touch-ups. An extremely practical and ergonomic solution that optimises the available space ensuring an excellent performance.

Ceramic corner bench with undoubled working place and lower module, 2 Aleva lighting units (T2A+LAMPTR), Fenix NTM® "Nero Ingo" worktop (RF720), DUSTINET II suction unit (ASPT) Colours PANTONE 647C



Everything in order, every day

To be effective, such a precise and delicate job needs one essential thing: order. POLO meets this requirement in the best possible way, allowing you to manage space, thanks to the instrument compartment, its distinctive feature designed to conceal and protect your instruments at the end of the day. Inside, you'll find a bur holder, an air syringe, and the workstation's general switch. An elegant and effective solution that allows POLO to be ready for a new session every day with all the order you need. And even more.





A modular approach

The POLO range is designed to create compositions that meet the requirements of your workplace in terms of space and functions, allowing you to operate comfortably and safely, whatever you are working on. Tailored solutions, designed and assembled with absolute precision thanks to the skill and experience of the Dental Art design team: it is this flexibility that makes POLO the ideal solution for even the most varied requirements, and the largest work spaces, from professional labs to school and university environments. And with the distinctive, elegant design of the Aleva lamp adding an extra, aesthetic rhythm to your composition, POLO proves that functionality and good looks can go together.





8 station composition, Fenix NTM[®] "Nero Ingo" worktop (RF720)





4 station composition, Fenix NTM® "Castoro Ottawa" worktop (RF717). Front colour PANTONE 7536C

2+1 station ceramic composition, Beechwood (RF1) and Fenix NTM® "Nero Ingo" (RF720) worktops



Top performance guaranteed

Dustinet II is the extraordinary evolution of an extraction system like no other in the world, thanks to its innovative No-Dust-Bag System. It's the result of Dental Art's technological and scientific research and an extraordinary step forward in terms of performance, as well as of economic and environmental sustainability. A universal solution that can be installed on any type of bench, not just those by Dental Art.

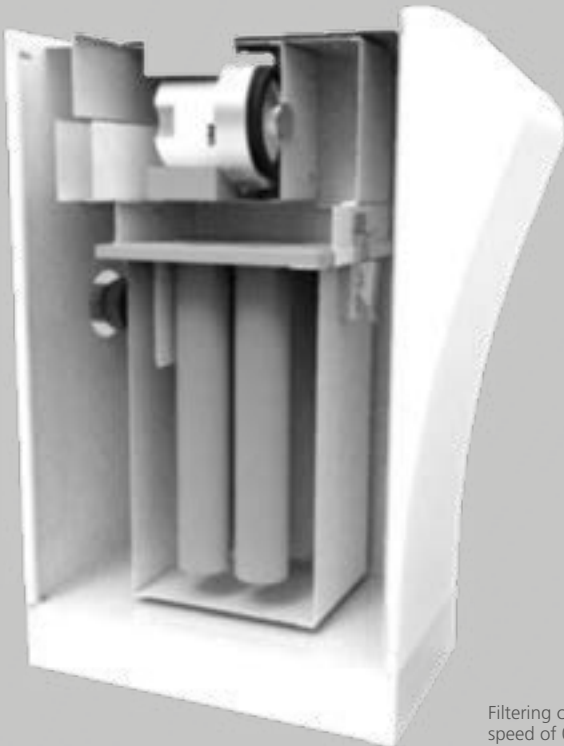

Filtering capacity 99.98% at an air speed of 0.056 m/s. Filtered surface: 0,16 m2



Wooden suction peg equipped with plexiglas protection screen, so as to work with open recovery drawer



Peg for front suction unit, complete of glass protection screen and wooden support base. Such peg is particularly indicated for works on the bench worktop

The revolutionary suction

Dustinet is the DentalArt designed suction system. It is revolutionary because it has unprecedented construction and functional features and ensures a level of working comfort never before experienced. The perfect complement for all DentalArt work benches, it is adaptable, with simple accessories, to all models currently on the market.

Dimensions	W=20 H=60 D=46cm
Weight	16 Kg
Noise	59dB(A)
Suction motor power	1100W
Air capacity when empty	18-28-38 l/sec
Internal diameter of suction pipe	4cm
Input fuse	315 mA on board - 6,3 A on motor







6 station composition Fenix NTM® "Nero Ingo" (RF720) worktops and shelves

3 station composition equipped with zirconium Box TZ as well as Box TF, laminate worktop (XSL)



MSIT
W75 H114 D65cm



MSTAND
W75 H144 D65cm

Worktop height 72/102cm,
integrated suction unit.



MBASIC
W57 H113 D62cm

Worktop height 76cm,
space for the housing of
DUSTINET II or existing
suction unit.



MDESK
W56 H55 D62cm

Free-standing module,
suction unit not included.

MILLY

Work the zirconium safely.
Four models to meet every need
and work practice.

Compact and ergonomic, Milly is a real assistant
and with its strong personality is the distinctive
touch of each dental laboratory.

Wide and bright working area with 2 + 2mm
safety glass, air dryer, wooden armrest,
removable front panel with magnet.

Inside the working area, bounded by glass
doors and protective silicon sleeves, there is
an air nozzle, a pressure gauge and a soft
perforated mat, so as to allow the suction of
waste products.

At the end of the work, the "air blades" allow
you to clean your hands from residual waste.



BOX TF

BOX TF, equipped with the revolutionary Dustinet II suction system, ensures effective performance, comfort, and safety.

Its reduced size (L85, D68, H130) makes it extremely easy to position. Suitable for any type of job and equipped with 2 suction nozzles. The fine dust extraction hose is positioned above the peg to ensure excellent visibility. The heavy dust extractor is located in the lower part of the bench and ensures an excellent performance in capturing sanding residues.

Its footboard, armrests integrated into the bench, retractable micromotor, and compressed air nozzles for cooling the artefacts make Box TF an extremely functional companion.

Moreover, the adjustable wooden peg adapts to the operator's characteristics and its double glazing ensures safety. Moreover, its 65-degree angle prevents reflection and ensures perfect visibility.



Bench accessories

For all your needs

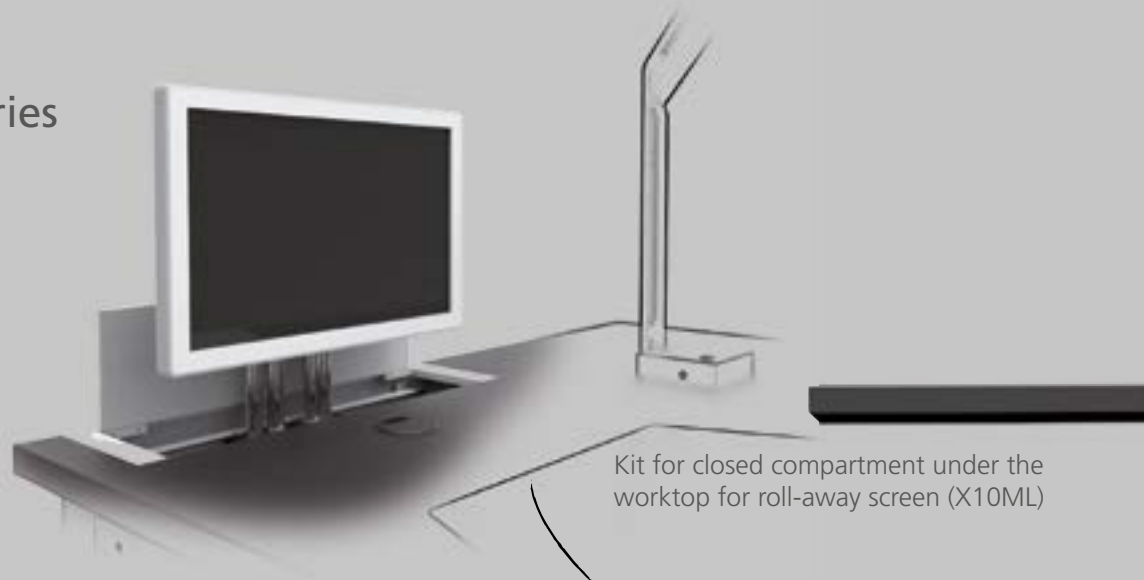

Kit for closed compartment under the worktop for roll-away screen (X10ML)



Housing for working station, without suction (TCB)



Housing with door for working station, without suction. Pressure opening (TCA)

Laminate, Beechwood, Corian®,
Fenix NTM® sheelf + side support (JRT)

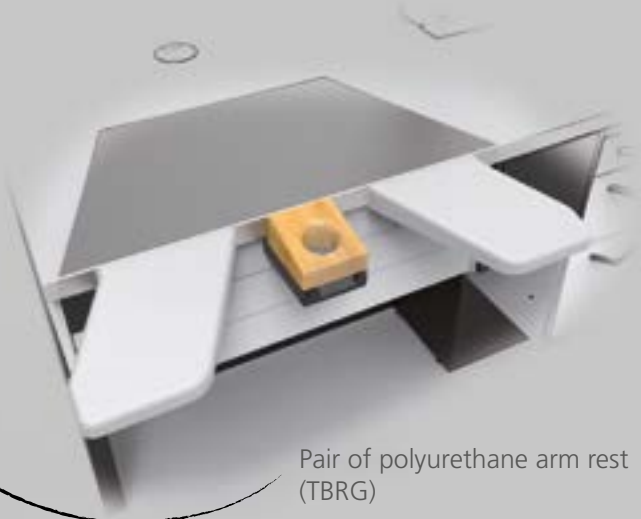

Pair of polyurethane arm rest
(TBRG)

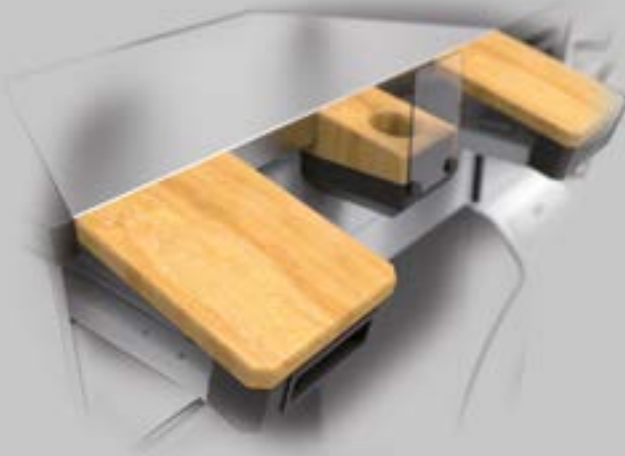

Extractable beech arm
rest (TBR)



- 1_ "Pearl Grey" Corian® worktop (RP1)
- 2_ Grey laminate worktop (X5L)
- 3_ "Grey expo" Silestone® Quarz worktop (QTL)
- 4_ "Nero Ingo" Fenix NTM® "worktop", soft-touch, anti fingerprints (RF720)
- 5_ "Castoro Ottawa" Fenix NTM® worktop, soft-touch, anti fingerprints (RF717)
- 6_ Beechwood worktop (RF1)
- 7_ "Grigio Londra" Fenix NTM® worktop, soft-touch, anti fingerprints (RF718)

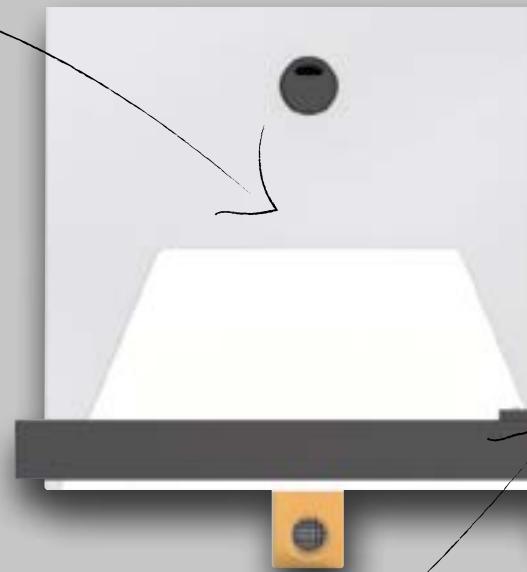

Lamp wire

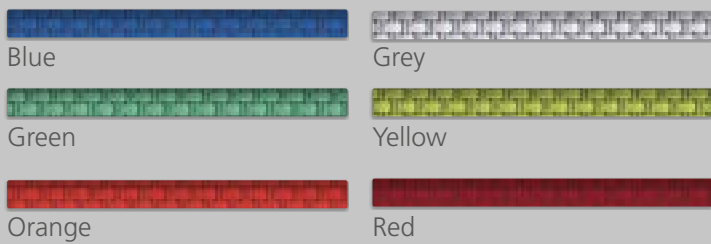

ALEVA lower energy led lighting unit, 5000K/2700 Lux, switch with dimmer device. Grey power cable (LAMPT). Grey power cable (LAMPT), blue (LAMPTB), yellow (LAMPTY), green (LAMPTG), red (LAMPTR), orange (LAMPTO)



2x24W lighting unit, with electronic ballast, mounted on the shelf, with height adjustable arm (LAMPBL)



Hub USB powered 2A applied to lighting unit base ALEVA

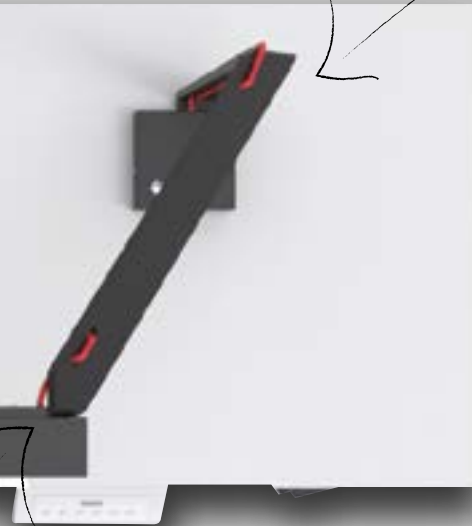

Stool with gas adjustment. Beech seat and back, with black padding, polished aluminium base (126DF)



Stool with gas adjustment. Beech seat and back (125FE)



Stool with gas adjustment. Shaped beech seat and back (125FS)



Stool with gas adjustment. Seat and back made of black polyurethane, polished aluminium base (126DE)



Automatic precision

Patience, attention, care. The human and individual factors are essential in the work of a dental technician. Technological progress has indeed advanced over the past few years, and POLO is perfectly in line with this evolution. Its CAD/CAM desk is the perfect completion for traditional workstations, allowing you, thanks to the scanner, to carry out operations that up to now had been performed in the casting area. A functional and tidy design island that optimises space and features a retractable monitor on the worktop. The best technology at your service.



1

Casting area

Fume hood (TK2), colour matt grey WA7021

2

Polishing and sandblasting

Table for polishing unit (TGT) + a 4 elements composition, laminate worktop and back rim (X5L+CT4L). Colour matt grey WA7021

At your service, every step of the way

The service units of the POLO range are an essential completion to your lab. They meet your every requirement, ensuring ergonomic and extremely organised work cycles both in larger and smaller settings. These units are extremely versatile, like only Dental Art can guarantee.



3

Plaster area

Corner compositionm 300+200cm, stainless steel worktop and sink (R3+R6), rolling unit with laminate worktop (X5L)

4

In-Out area

4 elements, laminate worktop and technical back rim (X5L+CT4L) as well as rack (BPA24)

Unit accessories

To complete your configuration

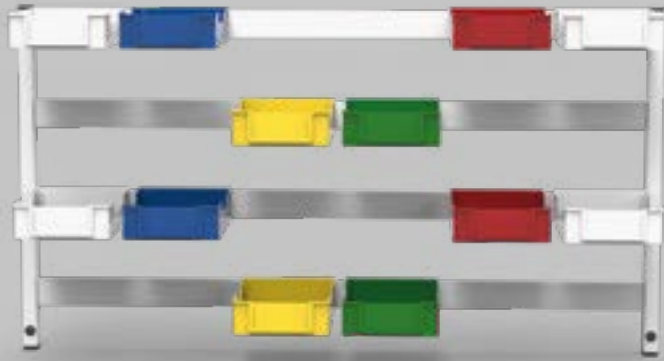

Rack for nr. 12/24 plastic container (BPA12, BPA24)



Articulators holders. Available colours white, red, yellow, green, blue (BPA)

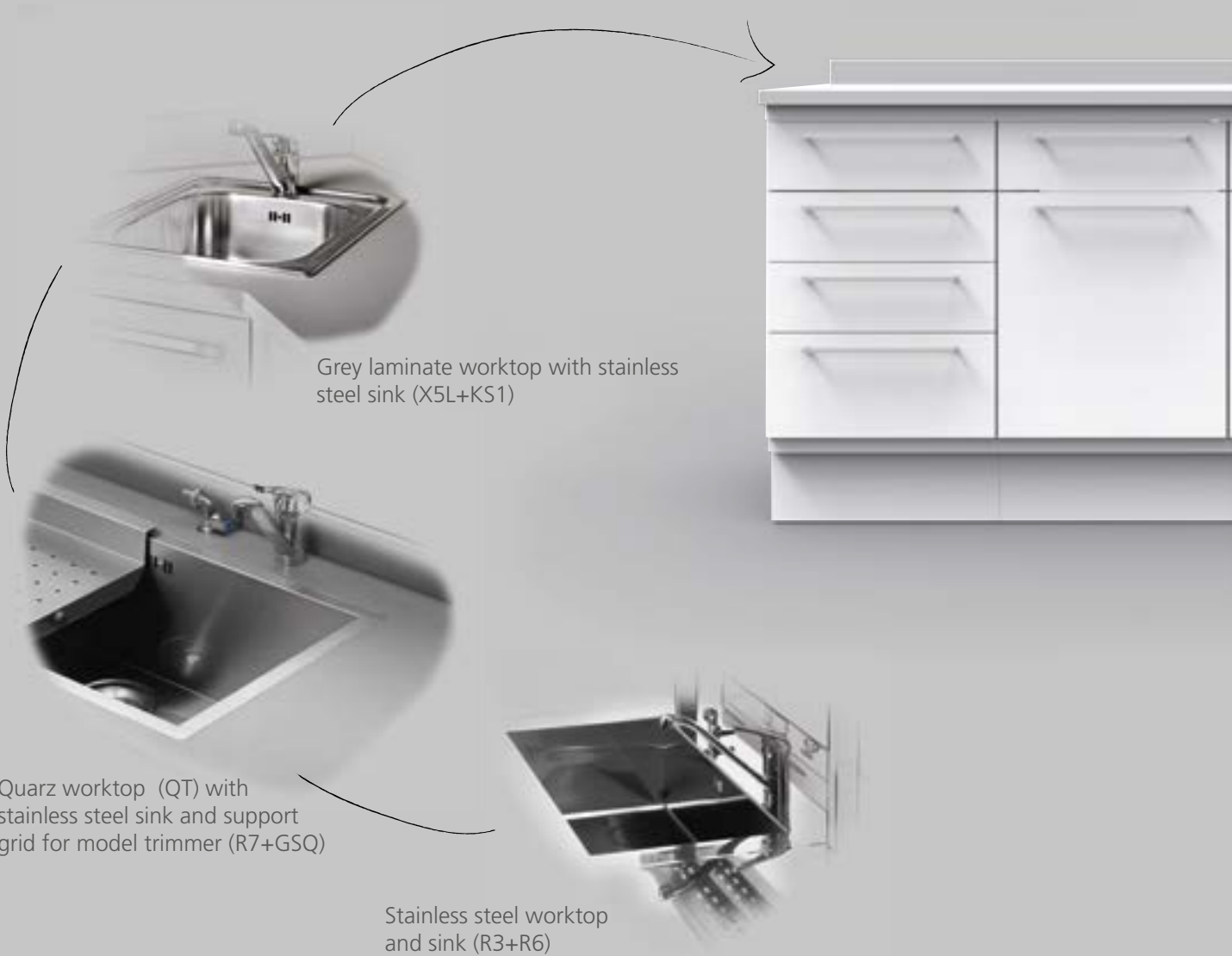

Grey laminate worktop with stainless steel sink (X5L+KS1)

Quarz worktop (QT) with stainless steel sink and support grid for model trimmer (R7+GSQ)

Stainless steel worktop and sink (R3+R6)

Also available: Corian®, Fenix NTM®, Beechwood



Hanging module with door and 3 height adjustable glass shelves (V8)



Hanging module with 2 doors as well as 3 height adjustable glass shelves (V9)



ABS plastic plaster trap (VD1)



Stainless steel plaster trap (VD3)

Fume hoods

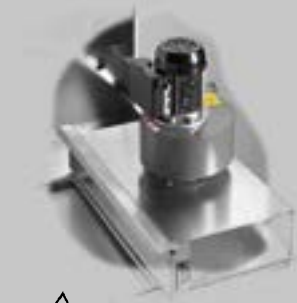

Hanging stainless steel fume hood equipped with air extractor and potentiometer (max. extraction power 900m³/hour), as well as metallic filter (KP1 L=120cm KP2 L=170cm)



Fume hood equipped with 400m³/hour, air extractor, metallic filter and arrangement for active carbon filter (TK1 L=125cm, TK2 L=150cm) complete with door cabinets



Hanging module with 2 doors as well as 3 height adjustable glass shelves (V9)



Built-in stainless steel gas cooker with two burners, automatic fire by a thermocouple (KS4)



Built-in stainless steel electric cooker with two burners. Current consumption 2,5Kw (KS6)

Measures

T0 - width 91 cm, depth 58 cm

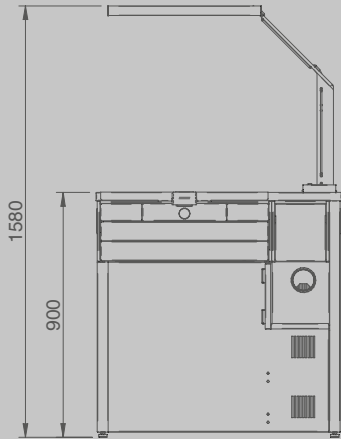

T0_C - width 141 cm, depth 58 cm

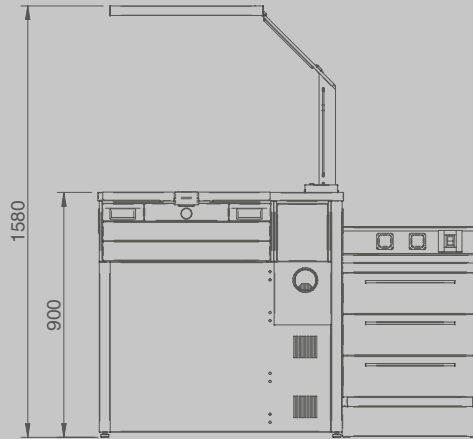

T1 - width 119 cm, depth 58 cm

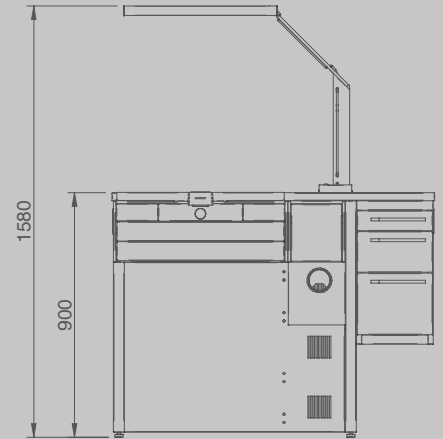

MILLY - width 75 cm, depth 65 cm

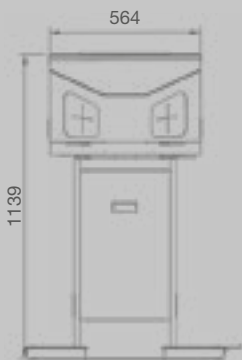

TF - width 85 cm, depth 68 cm

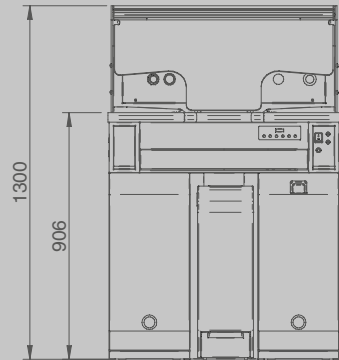

Basic features

BENCHES

- Frame - White WA005 / Grey mat WA7021
- Drawers - workstation drawers: push-to-open
- side drawers: soft closing device included
- Handles - Aluminium: grey mat WA7021 finishing
- Lamp - Grey mat WA7021
- Worktops - laminate, Fenix NTM®, beechwood, Corian®, Silestone® quartz

STORAGE CABINETS

- Frame - White WA005
- Drawers - soft closing device included
- Handles - Zama, aluminium finishing
- Worktops - laminate, Fenix NTM®, beechwood, Corian®, Silestone® quartz, stainless steel

T2 - width 233 cm, depth 58 cm

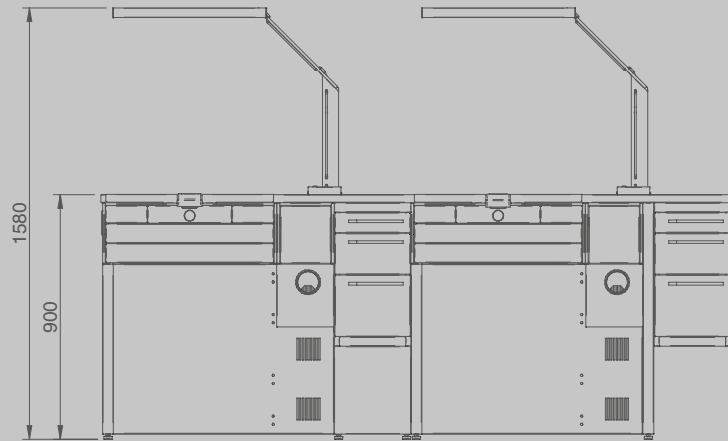

T2A - width 137/212 cm, depth 58 cm

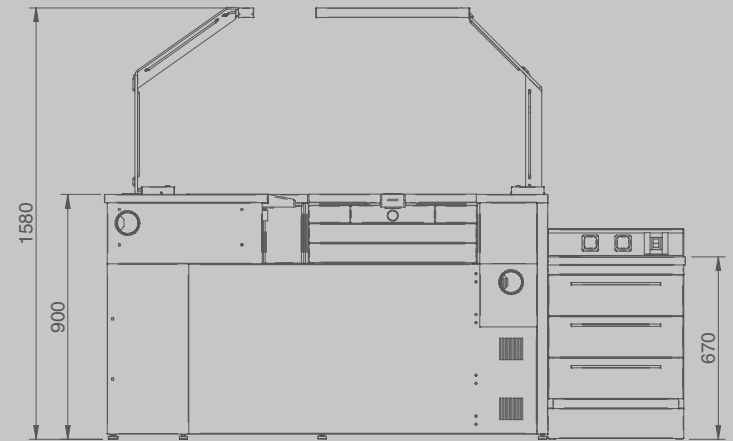

Mobili - width 202 cm, depth 50 cm



Want to explore the POLO universe still further?
At dental-art.it you can view and download the interactive version
of this catalogue, a PDF file with animated 3D models!



