

#whdentalwerk



video.wh.com

Now at
your dealer
or **wh.com**



valid from 01.01.2023

2023

Explanation of symbols

 with ring LED+ light

 with LED+ light

 with LED light

 with light

 without light

 integrated spray

 external spray

 without spray

 thermo washer disinfectable

 sterilizable

 disposable article

 latex-free

 foot control with cable

 wireless foot control

Table of contents



Restoration & Prosthetics	4-29
Endodontics	30-35
Prophylaxis & Periodontology	36-75
Oral surgery & Implantology	76-117
Drive	118-137
Sterilization, Hygiene & Maintenance	138-191
Dental laboratory	192-197
Osstell	198-201

Important information

- › Pictures are for illustrative purposes only. Additional equipment and accessories shown are not included as standard.
- › KaVo Multiflex®, NSK Mach®, NSK QD-J®, BienAir Unifix® and Sirona® are trademarks of third parties not affiliated with W&H Dentalwerk Bürmoos GmbH
- › All prices are recommended list prices in EURO, without VAT

Primea Advanced Air

Explanation of Symbols

-  with ring LED+ light
-  with LED+ light
-  with light
-  integrated spray
-  thermo washer disinfectable
-  sterilizable



Primea Advanced Air:
The world's first air-driven high-speed drive solution with an adjustable bur speed to provide constant removal rate, even with increasing pressure.



Ring LED+, up to 30 W
5-fold spray, head size Ø 10 mm,
press-button chuck system for FG burs
Ø 1.6 mm

RK-97 L
(Roto Quick connection*)
REF 30221000

1.727,-



LED+, up to 30 W
5-fold spray, head size Ø 10 mm,
press-button chuck system for FG burs
Ø 1.6 mm

RG-97 L
(Roto Quick connection*)
REF 30222000

1.369,-







For the full range of Primea Advanced Air, the Add-on or Built-in Kit will be required. See page 126

* Roto Quick couplings RQ-24 or RQ-34



Synea Vision

Explanation of Symbols

-  with ring LED+ light
-  with LED+ light
-  with light
-  integrated spray
-  thermo washer disinfectable
-  sterilizable



The new range of Synea Vision turbine handpieces:

Innovative technology and a comprehensive range of products for the highest demands.



led+

Ring LED+, 5-fold spray, 26 W,
head size Ø 13mm

TK-100 L
REF 30021000 **1.499,-**



led+

Ring LED+, 5-fold spray, 24 W,
head size Ø 11,5mm

TK-98 L
REF 30019000 **1.499,-**



led+

Ring LED+, 5-fold spray, 21 W,
head size Ø 10 mm

TK-97 L
REF 30017000 **1.499,-**



led+

LED+, 5-fold spray, 14 W,
head size Ø 9 mm

TK-94 L
REF 30016000 **1.376,-**



glass rod, 5-fold spray, 26 W,
head size Ø 13 mm

TK-100 LM
REF 30022000 **1.263,-**



glass rod, 5-fold spray, 24 W,
head size Ø 11,5 mm

TK-98 LM
REF 30020000 **1.263,-**



glass rod, 5-fold spray, 21 W,
head size Ø 10 mm

TK-97 LM
REF 30018000 **1.263,-**



glass rod, 5-fold spray, 14 W,
head size Ø 9 mm

TK-94 LM
REF 30031000 **1.263,-**

Roto Quick couplings RQ-24 / RQ-34 see page 118

* W&H coupling RM-34 LED see page 119



1:5, 5-fold spray, head size Ø 9,5mm,
press-button chuck system for FG burs
Ø 1,6 mm, glass rod

WK-99 LT
(ceramic ball bearings)
REF 30023000 **1.572,-**



1:4,5, 5-fold spray, head size Ø 9,1 mm,
press-button chuck system for FG burs
Ø 1,6 mm, glass rod

WK-93 LT
(ceramic ball bearings)
REF 30024000 **1.572,-**



1:1, single spray, head size Ø 9,5 mm,
press-button chuck system for contra-angle
burs Ø 2,35 mm, glass rod

WK-56 LT
REF 30025000 **1.066,-**



2:1, single spray, head size Ø 9,5 mm,
press-button chuck system for contra-angle
burs Ø 2,35 mm, glass rod

WK-66 LT
REF 30026000 **1.169,-**



8:1, single spray, head size Ø 9,5mm,
press-button chuck system for
contra-angle burs Ø 2,35 mm, glass rod

WK-86 LT
REF 30027000 **1.276,-**



1:1, single spray, Twist tension chuck system
for handpiece and contra-angle burs
Ø 2.35 mm, glass rod

HK-43 LT
REF 30028000 **1.036,-**



1:5, 5-fold spray, head size Ø 9,5mm,
press-button chuck system for FG burs
Ø 1,6 mm, glass rod

WK-99 LT S
(ceramic ball bearings)
REF 30215000

1.572,-



1:4,5, 5-fold spray, head size Ø 9,1 mm,
press-button chuck system for FG burs
Ø 1,6 mm, glass rod

WK-93 LT S
(ceramic ball bearings)
REF 30216000

1.572,-



1:1, single spray, head size Ø 9,5 mm,
press-button chuck system for contra-angle
burs Ø 2,35 mm, glass rod

WK-56 LT S
REF 30217000

1.066,-



2:1, single spray, head size Ø 9,5 mm,
press-button chuck system for contra-angle
burs Ø 2,35 mm, glass rod





WK-66 LT S
REF 30218000

1.169,-



Synea Fusion

Explanation of Symbols

- led+ with LED light
-  with light
-  without light
-  integrated spray
-  thermo washer disinfectable
-  sterilizable



Synea Fusion –
 be assured with proven
 Synea quality
 at an outstanding price

Turbine handpieces

turbine handpieces with NSK connection

turbine handpieces with Multiflex® connection*

* W&H coupling RM-34 LED see page 119



Quattro Spray, 21 W,
head size Ø 11,5 mm,

TG-98 L
(for RQ-24 / RQ-34*)
REF 30001000

TG-98 L RM
(standard 6-hole connection)
REF 30198000

TG-98 LW
for RA-24 / RA-25
REF 30202001

TG-98
(for RQ-03 / RQ-04 / RQ-14*)
REF 30002000

led+ 935,-

led+ 935,-

led+ 935,-

775,-



Quattro Spray, 18 W,
head size Ø 10 mm,

TG-97 L
(for RQ-24 / RQ-34*)
REF 30004000

TG-97 L RM
(standard 6-hole connection)
REF 30197000

TG-97 LW
(for RA-24 / RA-25)
REF 30201001

TG-97
(for RQ-03 / RQ-04 / RQ-14*)
REF 30005000

led+ 935,-

led+ 935,-

led+ 935,-

775,-

* Roto Quick couplings see page 116



glass rod,
Quattro Spray, 21 W,
head size Ø 11,5 mm

TG-98 L N
REF 30200000

935,-



glass rod,
Quattro Spray, 18 W,
head size Ø 10 mm

TG-97 L N
REF 30199000

935,-



glass rod,
Quattro Spray, 21 W,
head size Ø 11,5 mm

TG-98 LM
REF 30003000

935,-



glass rod,
Quattro Spray, 18 W,
head size Ø 10 mm

TG-97 LM
REF 30006000

935,-



1:5, Quattro Spray, head size Ø 9,5 mm, press-button chuck system for FG burs Ø 1,6 mm, glass rod

WG-99 LT
REF 30007000
WG-99 A
REF 30008000

1.192,-

903,-



1:1, single spray, head size Ø 9,5 mm, press-button chuck system for contra-angle burs Ø 2,35 mm, glass rod

WG-56 LT
REF 30009000
WG-56 A
REF 30010000

825,-

726,-



2:1, single spray, head size Ø 9,5 mm, press-button chuck system for contra-angle burs Ø 2,35 mm, glass rod

WG-66 LT
REF 30011000
WG-66 A
REF 30012000

979,-

801,-



1:1, press-button chuck system, head size Ø 9,5 mm, for FG burs Ø 1.6 mm, glass rod

WG-57 LT
REF 30212001

1.202,-



1:1, single spray, Twist tension chuck system for handpiece and contra-angle burs Ø 2.35 mm

HG-43 A
REF 30013000

600,-



Profin® contra-angle handpiece 2:1, single spray, stroke 1.1 mm, for Dentatus tips

WG-67 LT
REF 30084000
WG-67 A
REF 30085000

1.048,-

726,-

Contra-angle handpieces

Straight handpieces

Reciprocating contra-angle handpieces



Alegra

Explanation of Symbols

- led+ with LED+ light
- led with LED light
-  with light
-  without light
-  integrated spray
-  without spray
-  thermo washer disinfectable
-  sterilizable



Discover the new Alegra turbines with extremely quiet operation for daily use in your practice.

Designed to meet your needs with state-of-the-art technology. Made in Austria: For your best treatment results.

turbine handpieces with ceramic ball bearings and light



led!  

triple spray, 18 W,
head size Ø 12.2 mm

TE-98 LQ
REF 30067000 **709,-**



led!  

triple spray, 16 W,
head size Ø 10.4 mm

TE-97 LQ
REF 30066000 **709,-**

Roto Quick couplings with generator for Alegra turbine handpieces TE-97/98 LQ



Borden 2-hole connection, generator and water filter with resuction stop

RQ-53
REF 10405300 **298,-**



standard 4-hole connection, generator and water filter with resuction stop

RQ-54
REF 10405400 **298,-**

Turbine handpieces with ceramic ball bearings, without light





triple spray, 18 W,
head size Ø 12.2 mm

TE-98
(for RQ-03 / RQ-04 / RQ-14*)
REF 30071000 **583,-**

TE-98 BC
(Borden 2-hole connection)
REF 30072000 **583,-**

TE-98 RM
(Standard 4-hole connection)
REF 30073000 **583,-**



triple spray, 16 W,
head size Ø 10.4 mm

TE-97
(for RQ-03 / RQ-04 / RQ-14*)
REF 30068000 **583,-**

TE-97 BC
(Borden 2-hole connection)
REF 30069000 **583,-**

TE-97 RM
(Standard 4-hole connection)
REF 30070000 **583,-**

Turbine handpieces with steel ball bearings, without light



single spray, 18 W,
head size Ø 12.2 mm

TE-95 BC
(Borden 2-hole connection)
REF 30074000 **467,-**

TE-95 RM
(Standard 4-hole connection)
REF 30075000 **467,-**

* Roto Quick couplings see page 116

Contra-angle and straight handpieces, sleeve outer diameter 20 mm



1:1, press-button chuck system, head size Ø 10.1 mm, for contra-angle burs Ø 2.35 mm

WE-56
REF 30116000 **287,-**



1:1, press-button chuck system, head size Ø 10.1 mm, for FG burs Ø 1.6 mm

WE-57
REF 30117000 **287,-**



4:1, press-button chuck system, head size Ø 10.1 mm, for contra-angle burs Ø 2.35 mm

WE-66
REF 30118000 **347,-**



1:1, Twist tension chuck system for handpiece and contra-angle burs Ø 2.35 mm

HE-43
REF 30119000 **260,-**



1:4,5, triple spray, press-button chuck system, head size Ø 10.1 mm, for FG burs Ø 1.6 mm

WE-99 LED G
REF 10259900 **1.215,-**



1:1, single spray, press-button chuck system, head size Ø 10.1 mm, for contra-angle burs Ø 2.35 mm

WE-56 LED G
REF 10255600 **891,-**



4:1, single spray, press-button chuck system, head size Ø 10.1 mm, for contra-angle burs Ø 2.35 mm

WE-66 LED G
REF 10256600 **977,-**

Contra-angle handpieces, with light and generator

Contra-angle and straight handpieces, sleeve outer diameter 18 mm



1:1, press-button chuck system, head size Ø 10.1 mm, for contra-angle burs Ø 2.35 mm

WE-56 T
REF 30120000 **260,-**



1:1, press-button chuck system, head size Ø 10.1 mm, for FG burs Ø 1.6 mm

WE-57 T
REF 30121000 **260,-**



4:1, press-button chuck system, head size Ø 10.1 mm, for contra-angle burs Ø 2.35 mm

WE-66 T
REF 30122000 **322,-**



1:1, Twist tension chuck system for handpiece and contra-angle burs Ø 2.35 mm

HE-43 T
REF 30123000 **238,-**



1:1, press-button chuck system, head size Ø 10.1 mm, for contra-angle burs Ø 2.35 mm

WE-56 T MW Midwest handpiece connection*
REF 30124001 **646,-**

WE-56 T SD Star Dental handpiece connection**
REF 30127001 **646,-**



1:1, press-button chuck system, head size Ø 10.1 mm, for FG burs Ø 1.6 mm

WE-57 T MW Midwest handpiece connection*
REF 30125001 **646,-**

WE-57 T SD Star Dental handpiece connection**
REF 30128001 **646,-**



1:1, Twist tension chuck system for handpiece and contra-angle burs Ø 2.35 mm

HE-43 T MW Midwest handpiece connection*
REF 30126001 **646,-**

HE-43 T SD Star Dental handpiece connection**
REF 30129001 **646,-**

* W&H airmotors with Midwest handpiece connection: AM-20 MW RQ/ RM, AM-05 MW RQ/ RM (see page 124)

** W&H airmotors with Star Dental handpiece connection: AM-20 SD RQ/ RM, AM-05 SD RQ/ RM (see page 125)



BC
coupling seal BC
REF 01000700
coupling seal RM
REF 02207300

RM
3,59
4,50

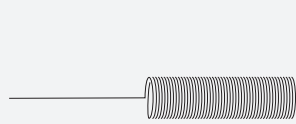

short nozzle cleaner
for turbine, contra-angle
and straight handpieces
REF 02015101

4,40



O-ring set
for Roto Quick couplings
REF 07508900

6,60



Torque wrench
for replacing the rotor
REF 07508800

74,-



Generator for RQ-53
REF 06840300
Generator for RQ-54
REF 06793000

174,-
174,-



Water filter with resuction stop
for BC connections
REF 07092500
for RM connections
REF 07095500

37,10
37,10



Rotor with hexagon wrench for TE-98 LQ,
TE-98, TE-98 BC, TE-98 RM
REF 06787500
for TE-97 LQ, TE-97, TE-97 BC, TE-97 RM
REF 07234100
for TE-95 RM
REF 07495400
for TE-95 BC
REF 07507300

277,-
277,-
239,-
239,-



Push-button
for TE-95 RM, TE-95 VC,
TE-98, TE-98 RM, TE-98 BC
REF 06641900
for TE-97, TE-97 RM, TE-97 BC
REF 07548000

43,40
43,40



Bur extension
REF 01312500

4,80



Threaded pin
REF 01312600

2,84



Contra-angle head
for WE-56
REF 07549900
for WE-57
REF 07550000
for WE-66
REF 07550100

197,-
197,-
197,-

SMARTREPAIR

Tool kit for replacing
of contra-angle heads
REF 07550300

112,-



Spray clip with 3 coolant
hoses and nozzle cleaner for
straight handpiece HE-43
REF 07550200

18,60



Spray clip with 3 coolant hoses and
nozzle cleaner for contra-angle
handpieces WE-56, WE-57, WE-66
REF 06994000

18,60

Low-speed set



consists of:

- › WE-56 T
- › HE-43 T
- › AM-20 RM

Low-speed set 1 RM
REF 90000123 894,-



consists of:

- › WE-56 T
- › HE-43 T
- › AM-20 BC

Low-speed set 1 BC
REF 90000124 894,-

High-speed set



consists of:

- › TE-95 RM
- › WE-56 T
- › HE-43 T
- › AM-20 RM
- › Nozzle cleaner

High-speed set 1 RM
REF 90000125 1.361,-



consists of:

- › TE-95 BC
- › WE-56 T
- › HE-43 T
- › AM-20 BC
- › Nozzle cleaner

High-speed set 1 BC
REF 90000126 1.361,-

Accessories



Place for 17 turbine handpieces, contra-angle and straight handpieces, 3 micromotors, 2 couplings

Transportation and presentation case, big
REF 06505300 111,-



Place for 7 turbine handpieces, contra-angle and straight handpieces

Transportation and presentation case, small
REF 06240900 92,50

endea

Endea

Explanation of Symbols

-  without light
-  without spray
-  thermo washer disinfectable
-  sterilizable

The Endea contra-angle handpieces with their extra small heads provide even better access to the treatment area.

Root canal preparation with 360° rotation is possible using both the Crown-down and the Single-length techniques.



Contra-angle handpieces



16:1,
press-button
chuck system

EB-75
REF 12227501

631,-



2:1,
press-button
chuck system

EB-79
REF 12227901

568,-

Endodontics

Suitable inserts

All root canal files, suitable for 360° rotation, particularly nickel-titanium files with shank diameter 2.35 mm, according to EN ISO 1797-1:1995.

Re-order files

Please re-order files at your responsible dental dealer or directly at Sendoline (www.sendoline.com).

endo niti
Endo NiTi

Explanation of Symbols

-  without light
-  without spray
-  thermo washer disinfectable
-  sterilizable

For the preparation of the root canal with rotating NiTi files.



Contra-angle handpieces



70:1,
 press-button
 chuck system
WD-73 M
 REF 10217302 631,-



128:1,
 press-button
 chuck system
WD-74 M
 REF 10217402 664,-

Endodontics

Suitable inserts

All root canal files, suitable for 360° rotation, particularly nickel-titanium files with shank diameter 2.35 mm, according to EN ISO 1797-1:1995.

Re-order files

Please re-order files at your responsible dental dealer or directly at Sendoline (www.sendoline.com).

Endo Cursor

Explanation of Symbols

-  without light
-  without spray
-  thermo washer disinfectable
-  sterilizable



Endo Cursor



4:1, press-button chuck system,
for root canal hand files with shank diameter
3.6 – 4.0 mm

EB-62

REF 12226201

739,-

Contra-angle handpiece

Endodontics

**For the mechanical
preparation of the root
canal with hand files.**

Piezo Scaler Proxeo Ultra PB-510 / 520 / 530

Explanation of Symbols



compatibility with
pacemakers



The new Proxeo Ultra piezo scalers from W&H were developed in collaboration with prophylaxis professionals and really live up to their name. Exclusive user advantages allow ultra efficient treatment.

PB-530



Set PB-5 L Q

(with W&H Q-link - quick connection)

REF 90000258

2.518,-

Set PB-5 L

(with W&H / EMS / Mectron standard thread)

REF 90000257

2.518,-

Set PB-5 L S

(with W&H/Satelec/NSK thread)

REF 90000297

2.518,-

- › Control unit PB-530 with coolant tank, switch-mode power supply and 1.8 m supply hose
- › Foot control C-NW
- › Cable (pairing/charging) for C-NW

Set PB-5 L Q

- › Handpiece PB-5 L Q
- › Tips: 1UQ, 2UQ, 1PQ, 1IQ incl. tip exchanger with torque limitation

Set PB-5 L

- › Handpiece PB-5 L
- › Tips: 1U, 2U, 1P, 1I incl. tip exchanger with torque limitation

Set PB-5 L S

- › Handpiece PB-5 L S
- › Tips: 1US, 2US, 3US, 1PS incl. tip exchanger with torque limitation

PB-520



Set PB-5 L Q

(with W&H Q-link - quick connection)

REF 90000256

2.176,-

Set PB-5 L

(with W&H / EMS / Mectron standard thread)

REF 90000255

2.176,-

Set PB-5 L S

(with W&H/Satelec/NSK thread)

REF 90000296

2.176,-

- › Control unit PB-520 with coolant tank, switch-mode power supply and 1.8 m supply hose
- › Foot control C-NF

Set PB-5 L Q

- › Handpiece PB-5 L Q
- › Tips: 1UQ, 2UQ, 1PQ incl. tip exchanger with torque limitation

Set PB-5 L

- › Handpiece PB-5 L
- › Tips: 1U, 2U, 1P incl. tip exchanger with torque limitation

Set PB-5 L S

- › Handpiece PB-5 L S
- › Tips: 1US, 2US, 1PS incl. tip exchanger with torque limitation

PB-510



Set PB-5 L Q

(with W&H Q-link - quick connection)

REF 90000254

1.489,-

Set PB-5 L

(with W&H / EMS / Mectron standard thread)

REF 90000253

1.489,-

Set PB-5 L S

(with W&H/Satelec/NSK thread)

REF 90000295

1.489,-

- › Control unit PB-510 with coolant hose and filter, switch-mode power supply and 1.8 m supply hose
- › Foot control C-NF

Set PB-5 L Q

- › Handpiece PB-5 L Q
- › Tips: 1UQ, 2UQ, 1PQ incl. tip exchanger with torque limitation

Set PB-5 L

- › Handpiece PB-5 L
- › Tips: 1U, 2U, 1P incl. tip exchanger with torque limitation

Set PB-5 L S

- › Handpiece PB-5 L S
- › Tips: 1US, 2US, 1PS incl. tip exchanger with torque limitation



PB-5 L Q

(with W&H Q-link - quick connection)

REF 30327000

688,-



PB-5 L (W&H)

(with W&H / EMS / Mectron standard thread)

REF 30326000

688,-

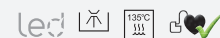

PB-5 L S

(with W&H/Satelec/NSK thread)

REF 30328000

688,-

Proxeo Ultra handpieces



Control unit PB-530 with coolant tank, switch-mode power supply, supply hose and Cable (pairing/charging) for C-NW
REF 30325000 **1.660,-**



Control unit PB-520 with coolant tank, switch-mode power supply and supply hose
REF 30324000 **1.489,-**



Control unit PB-510 with coolant hose and filter, switch-mode power supply and supply hose
REF 30323000 **801,-**



Tank
REF 07991190 **172,-**



o-ring for coolant tank
REF 07960870 **3,05**



pump cartridge
REF 08001660 **72,-**



O-ring for hose coupling
REF 02060203 **2,22**

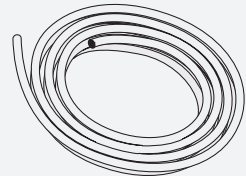

Coolant hose
REF 05075600 **13,-**



Foot control C-NW
REF 30316000 **343,-**



LED socket (3 pcs) incl. handpiece cap
REF 08025210 **56,10**



C-NF foot control
REF 04717300 **84,-**



Coolant filter
REF 02675000 **15,-**





Cable (pairing/charging) for C-NW
REF 08014700 **21,70**



Long nozzle cleaner
REF 00636901 **5,30**









- › Removal of sub- and supragingival calculus in all quadrants
- › The entire treatment can be carried out without the tedious job of changing tips

Universal 1UQ with tip changer
REF 08023920 **74,50**

Universal 1U with tip changer
REF 05076200* **74,50**

Universal 1US with tip changer
REF 07983820 **74,50**



- › Visibly longer and narrower 2U tips
- › Treatment of recall patients
- › For fine finishing
- › Fine scaling of supragingival calculus
- › Removal of plaque

Universal 2UQ with tip changer
REF 08023930 **80,50**

Universal 2U with tip changer
REF 05076300* **80,50**

Universal 2US with tip changer
REF 07983830 **80,50**











- › Slightly rounded and also particularly narrow and short
- › Fine scaling in the supragingival region
- › Ideal instrument for cleaning the interdental spaces

Universal 3UQ with tip changer
REF 08023940 **94,-**

Universal 3U with tip changer
REF 05368200* **94,-**

Universal 3US with tip changer
REF 07983850 **94,-**



- › Perfect tip for removing large areas of calculus

Universal 4U with tip changer
REF 05849201 **80,50**

Tip description:

1U without S or Q	1U for W&H / EMS / Mectron standard thread
1US	1U for W&H / Satelec / NSK thread
1UQ	1U for W&H Q-link (quick connection)

* also for Pyon 1 suitable



For supportive periodontitis treatment (SPT), recall and biofilm management









- › Removal of concretions in the subgingival region
- › Especially suitable for the treatment of deep periodontal pockets

Periodontology 1PQ with tip changer
REF 08023950 **106,-**

Periodontology 1P with tip changer
REF 05370400* **106,-**

Periodontology 1PS with tip changer
REF 07983860 **106,-**







- › Recommended for maintenance treatment on medium-depth to deep pockets as well as furcations

Periodontology 3PrQ with tip changer
REF 08023960 **137,-**



Periodontology 3Pr with tip changer
REF 06364900 **137,-**

Periodontology 3PIQ with tip changer
REF 08023980 **137,-**

Periodontology 3PI with tip changer
REF 06365000 **137,-**

For initial periodontitis treatment and removal of concretions









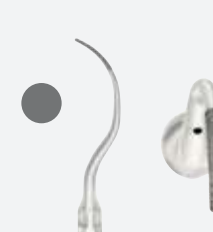

- › Diamond-coated tip for cleaning the root surface

Periodontology 4PQ with tip changer
REF 08024010 **155,-**

Periodontology 4P with tip changer
REF 07965670 **155,-**

Periodontology 4PS with tip changer
REF 07983870 **155,-**



- › Diamond-coated tip for cleaning furcations and concavities









Periodontology 5PQ with tip changer
REF 08024040 **170,-**

Periodontology 5P with tip changer
REF 07965600 **170,-**







For initial periodontitis treatment

- › Diamond-coated tip for cleaning the root surface

Periodontology 5PrQ with tip changer REF 08024020	 	170,-
Periodontology 5Pr with tip changer REF 07965660	 	170,-
Periodontology 5PIQ with tip changer REF 08024030	 	170,-
Periodontology 5PI with tip changer REF 07965620	 	170,-





- › Non-cutting instrument for effective rinse activation in the root canal system



Endodontie 1E with spanner REF 06367900	 	118,-
Endodontie 1ES with spanner REF 07983880	 	118,-

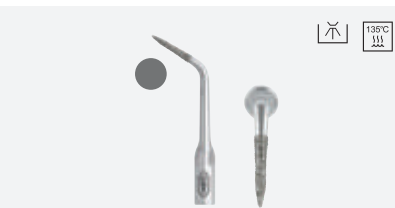

- › Tip for lateral thermal condensation of gutta-percha

Endodontics 2E with spanner REF 06368000	 	96,-
--	---	-------------



Restoration 1R with tip changer REF 05849401	 	106,-
--	---	--------------

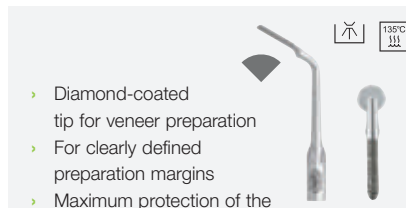

- › Expanding of fissures



Restoration 2R with tip changer REF 06368400	 	119,-
--	---	--------------

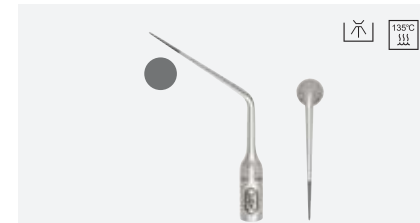

- › Diamond-coated tip for veneer preparation
- › For clearly defined preparation margins
- › Maximum protection of the gingiva and the neighbouring tooth

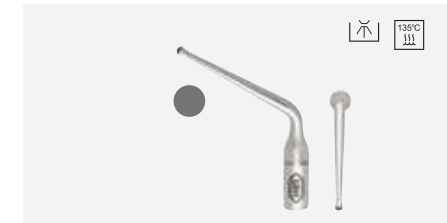

Endodontics 3E with spanner REF 06368100	 	125,-
--	---	--------------

- › Removing of broke instruments in the root canal



Endodontics 4E with spanner REF 07812300	 	134,-
--	---	--------------

- › Preparation of the pulp chamber

For Restoration

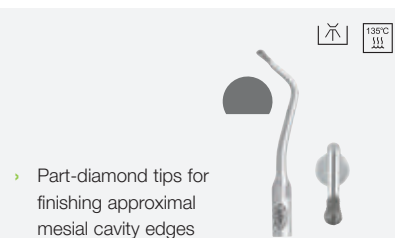

Restoration 3Rm with tip changer REF 06368500	 	119,-
---	---	--------------

- › Part-diamond tips for finishing approximal mesial cavity edges

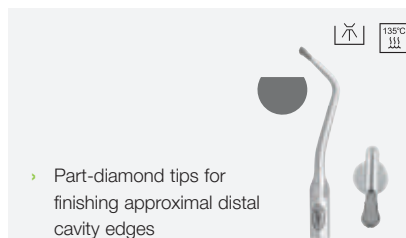

Restoration 3Rd with tip changer REF 06368600	 	119,-
---	---	--------------

- › Part-diamond tips for finishing approximal distal cavity edges

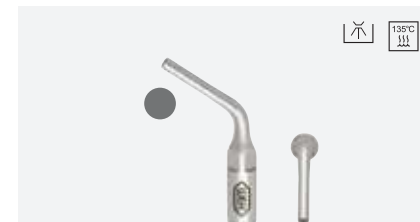

For Endodontics

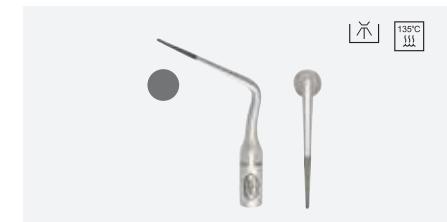

Endodontics 5E with tip changer REF 07812400	 	125,-
--	---	--------------

- › Vibrating and removal of root canal posts



Endodontics 6E with spanner REF 07812500	 	125,-
--	---	--------------

- › Removal of root canal fillings and root canal calcifications



1U **3U** **1P**

consists of:

- > tip 1U, 3U, 1P (1 pc)
- > tip changer with torque limitation (3 pcs)
- > tip card

universal tip set
REF 05851800* **274,-**

consists of:

- > tip 1I (3 pcs)
- > tip changer with torque limitation (3 pcs)

implant clean tip set (3x 1IQ)
REF 08026380 **309,-**

implant clean tip set (3x 1I)
REF 06370500 **309,-**

1E **2E** **3E**

4E **5E** **6E**

consists of:

- > tip 1E, 2E, 3E, 4E, 5E, 6E (1 pc)
- > spanner (1 pc) for tip 1E, 2E, 3E, 4E, 6E
- > tip changer with torque limitation (1 pc) for tip 5E
- > tip card

endo tip set
REF 07812200 **681,-**

TS-1 **TW-1**

TQ-1

tip changer with torque limitation

TW-1: for tips with W&H thread (z.B. 1U, 2U)
REF 04982800 **31,-**

TS-1: for tips with Satelec thread (z.B. 1US, 2US)
REF 07984290 **31,-**

TQ-1: for tips with W&H Q-Link (quick connection)
REF 07985850 **31,-**





Sets

Accessories



Air scaler

Explanation of Symbols

-  with light
-  without light
-  integrated spray
-  thermo washer disinfectable
-  sterilizable



Fast, gentle, powerful.

The air-driven scaler with the integrated spray and two large optic outlets is ideal for the removal of plaque and calculus as well as cleaning root surfaces. The result: your patients feel better in general and more self-confident thanks to their clean teeth surfaces.

With Roto Quick connection*



with tips 1AU, 2AU, 3AU and 1AP;
tip changer, nozzle cleaner,
small cleaning brush and tip card

ZA-55
REF 10035501

1.038,-

* Roto Quick couplings see page 116

With Multiflex® connection*



with power regulation and tips
1AU, 2AU, 3AU and 1AP; tip changer, nozzle
cleaner, small cleaning brush and tip card

ZA-55 LM
REF 10035502

1.629,-



with tips 1AU, 2AU, 3AU and 1AP;
tip changer, nozzle cleaner,
small cleaning brush and tip card

ZA-55 M
REF 10035503

1.038,-

* coupling with LED light see page 119

With fixed connection



with tip 1AU (2 pcs), open-ended spanner,
nozzle cleaner, small cleaning brush and tip card

ZE-55 BC
REF 11015500

592,-



with tip 1AU (2 pcs), open-ended spanner,
nozzle cleaner, small cleaning brush and tip card

ZE-55 RM
REF 11015501

592,-

With Sirona® connection



with power regulation and tips 1AU, 2AU, 3AU
and 1AP; tip changer, nozzle cleaner, small
cleaning brush and tip card

ZA-55 LS
REF 30227000

1.629,-



universally applicable, also for curved molar
surfaces with lingual inclination

tip 1AU with tip card
REF 07159700

74,-



for anterior teeth of the lower jaw, lingual
surfaces and in cases of stubborn adhesion
of thick, hard collars of dental calculus

tip 2AU with tip card
REF 07159800

74,-



for removing plaque from the neck of the tooth
and removing nicotine stains

tip 3AU with tip card
REF 07159900

74,-



removal of subgingival deposits, especially
suitable for deep periodontal pockets

tip 1AP with tip card
REF 07009100

84,50



tip for removal of subgingival deposits.
Right-curved and leftcurved models available

tip 2APr with tip card
REF 05254400

84,50



tip for removal of subgingival deposits.
Right-curved and leftcurved models available

tip 2API with tip card
REF 05153300

84,50



With a diamond coating on the instrument tip
for periodontal debridement of furcations
and concavities.

tip 3AP with tip card
REF 05280200

113,-

Tips

Prophylaxis & Periodontology



tip changer
REF 07308100 49,-

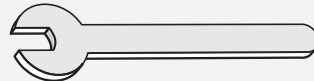

open-ended spanner
SW4
REF 04510700 22,80

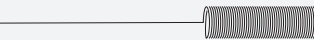

long nozzle cleaner
REF 00636901 5,30

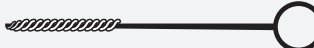

small cleaning brush
REF 05452400 8,40



BC **RM**

coupling seal BC
REF 01000700 3,59

coupling seal RM
REF 02207300 4,50

Parts available after sale



Air Polishing System



Proxeo Aura – Air Polishing System

This system with an air polishing handpiece and the corresponding powders allows you to remove supra- and subgingival biofilm, as well as stains efficiently, thoroughly and under control.



Proxeo Aura prophy set

- › Air polishing handpiece
- › Spray head 120°
- › Prophylaxis Powder SOFT+ (250 g)
- › Accessories

Connection

PF-60 (W&H RotoQuick)	
REF 08020760	1.093,-
PF-60 M (Kavo Multiflex)	
REF 08020770	1.093,-
PF-60 N (NSK)	
REF 08020780	1.093,-
PF-60 S (Sirona)	
REF 08020790	1.093,-



Proxeo Aura perio set

- › Air polishing handpiece
- › Spray head 120°
- › Spray head perio
- › Subgingival perio tips (40 pcs)
- › Prophylaxis Powder SOFT+ (250 g)
- › Prophylaxis Powder SENSITIVE+ (160 g)
- › Accessories

Connection

PF-60 (W&H RotoQuick)	
REF 08020761	1.363,-
PF-60 M (Kavo Multiflex)	
REF 08020771	1.363,-
PF-60 N (NSK)	
REF 08020781	1.363,-
PF-60 S (Sirona)	
REF 08020791	1.363,-



Sodium Bicarbonate, 4x250 g,
Ø Particle size: 40 µm

Prophylaxis Powder SOFT+
REF 08020870 **86,-**



Glycine, 2x160 g, Ø Particle size: 25 µm

Prophylaxis Powder SENSITIVE+
REF 08020890 **59,50**



Spray head 120°
REF 08020810 **228,-**



Spray head short 120°
REF 08020840 **228,-**



Spray head 90°
REF 08020800 **228,-**



Spray head short 90°
REF 08020830 **228,-**



Spray head perio
REF 08020820 **228,-**



Spray head short perio
REF 08020850 **228,-**



Subgingival perio tips
(40 pcs)
REF 08020860 90,50



O-ring set
1 green, 2 black
REF 08020900 10,30

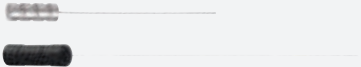

Cleaner set
1 needle 0.8 mm,
1 needle 0.4 mm, 1 brush
REF 08020910 34,30



Cap for powder container
(incl. 1 O-ring green)
REF 08020920 43,60









K9 wrench
REF 08020930 20,60



Contra-angle and straight handpieces

Explanation of Symbols

-  without light
-  without spray
-  thermo washer disinfectable
-  sterilizable
-  latex-free
-  disposable article

Standard latch vs LatchShort



Rotary polishing system

In modern dental treatment, the professional, mechanical removal of plaque and biofilm is an integral part of the prophylaxis workflow. With Proxexo TWIST, W&H offers a compact, easy to handle solution for everything you need, no matter whether it is cleaning, polishing or fluoridating!



4:1, contra-angle handpiece system
LatchShort for all W&H LatchShort Prophy
Cups / -Brushes

WP-66 W
REF 30189000 **464,-**



LATEX ⓧ

soft / apple green
LatchShort

Prophy Cups
144 pcs REF 08003630 **79,-**



LATEX ⓧ

firm / dark green
LatchShort

Prophy Cups
144 pcs REF 07597900 **79,-**



LATEX ⓧ

cup-shaped
soft / clear
LatchShort

Prophy Brushes
144 pcs REF 08003650 **110,-**



4:1, contra-angle handpiece system
UNIVERSAL with Snap-on adaptor and key
for all standard Screw-in cups, brushes and
Snap-on adaptor

WP-64 MU
REF 10216443 **464,-**



4:1, contra-angle handpiece system YOUNG
with key, for YOUNG Screw-in cups and
brushes

WP-64 M
REF 10216403 **464,-**

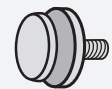

snap-on adaptor for WP-64 MU
REF 04530600 **12,70**



key
REF 01957300 **1,47**



4:1, straight handpiece for disposable contra-
angles with plastic shank, system Doriot

HP-44 M
REF 10114403 **381,-**



4:1, contra-angle handpiece for all cups,
brushes and Snap-on adaptor with
2,35 mm shank

WP-66 M
REF 30190000 **464,-**

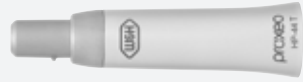

4:1, straight handpiece for disposable contra- angles with plastic shank, system Doriot

HP-44 T
REF 30191003

646,-



4:1, contra-angle handpiece system YOUNG with key, for YOUNG Screw-in cups and brushes

WP-64 T
REF 30192002

646,-



4:1, straight handpiece (short) for disposable contra- angles with plastic shank, system Doriot

HP-44 TS
REF 30313001

544,-



4:1, contra-angle handpiece (short) system YOUNG with key, for YOUNG Screw-in cups and brushes

WP-64 TS
REF 30314001

544,-



4:1, straight handpiece (short) for disposable contra-angles with plastic shank, system Doriot

HP-44 T MW Midwest handpiece connection*
REF 30079001

544,-

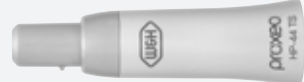

4:1, straight handpiece (short) for disposable contra-angles with plastic shank, system Doriot

HP-44 T SD Star Dental handpiece connection**
REF 30080001

544,-



4:1 prophy handpiece with airmotor and RQ connection for disposable contra-angles with plastic shank, system Doriot

Proxeo Set AP-20 RQ + HP-44 TS
REF 90000364

781,-



4:1 prophy contra-anlge handpiece with airmotor and RQ connection for YOUNG Screw-in cups and brushes

WP-64 TS + AP-20 RQ
REF 90000365

896,-



4:1 prophy handpiece with airmotor and RM connection for disposable contra-angles with plastic shank, system Doriot

Proxeo Set AP-20 RM + HP-44 TS
REF 90000366

781,-



4:1 prophy contra-anlge handpiece with airmotor and RM connection for YOUNG Screw-in cups and brushes

WP-64 TS + AP-20 RM
REF 90000367

896,-

* W&H airmotors with Midwest handpiece connection:
AM-20 MW RQ/ RM, AM-05 MW RQ/ RM (see page 124)

** W&H airmotors with Star Dental handpiece connection:
AM-20 SD RQ/ RM, AM-05 SD RQ/ RM (see page 125)

Cordless Polishing System



Cordless polishing means polishing entirely without restrictions

Twist and turn the ergonomically designed, light handpiece at will and change your position as needed. This allows you to access practically any angle during polishing and ensures a good view of the treatment site.

Prophylaxis & Periodontology

Prophylaxis & Periodontology



PL-40 H Proxeo Twist Cordless System Doriot, consists of:

- › PL-40 H handpiece drive incl. handpiece sleeve
- › Foot control C-NW
- › Charger with adaptor
- › Handpiece holder

REF 30317000 **1.313,-**



PL-40 HW Proxeo Twist Cordless System LatchShort, consists of:

- › PL-40 HW handpiece drive
- › PL-66 W for System LatchShort
- › Foot control C-NW
- › Charger with adaptor
- › Handpiece holder

REF 90000346 **1.313,-**



PL-40 HW Proxeo Twist Cordless System Doriot, consists of:

- › PL-40 HW handpiece drive
- › PL-44 for System Doriot
- › Foot control C-NW
- › Charger with adaptor
- › Handpiece holder

REF 90000348 **1.313,-**



LATEX 

soft / apple green, LatchShort

Prophy Cups
144 pcs REF 08003630 **79,-**



LATEX 

firm / dark green, LatchShort

Prophy Cups
144 pcs REF 07597900 **79,-**



LATEX 

cup-shaped, soft / clear, LatchShort

Prophy Brushes
144 pcs REF 08003650 **110,-**



Prophy Angle Cups 105°
firm / dark green
100 pcs
REF 07979710 **85,-**



Prophy Angle Cups 105°
soft / apple green
100 pcs
REF 07994950 **85,-**

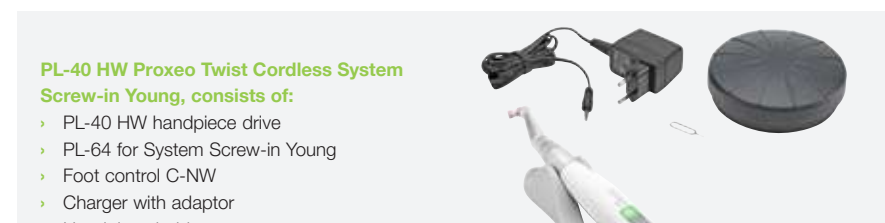

PL-40 HW Proxeo Twist Cordless System Screw-in Young, consists of:

- › PL-40 HW handpiece drive
- › PL-64 for System Screw-in Young
- › Foot control C-NW
- › Charger with adaptor
- › Handpiece holder

REF 90000347 **1.313,-**

Proxeo Twist Cordless



drive handpiece PL-40 H
REF 07954780 **918,-**



foot control C-NW
REF 30316000 **343,-**



handpiece sleeve
REF 07918800 **74,50**



carrying case
REF 08025020 **285,-**



charger with adaptor
REF 07969610 **97,50**



handpiece holder
REF 05882600 **35,40**



PL-44
for System Doriot
REF 30098000 **309,-**



PL-64
for System Screw-in Young
REF 30097000 **375,-**



PL-66 W
for System LatchShort
REF 30096000 **375,-**



drive handpiece
PL-40 HW
REF 07947190 **891,-**



Assistina adaptor for
handpiece-/contra-angle head
REF 05204600 **172,-**

Prophylaxis & Periodontology

Accessories

Prophylaxis & Periodontology

Proxeo Combi-Set (Ultra & Twist Cordless)

proxeo^{TWIST}

proxeo^{ULTRA}



Convenient, wireless and efficient:

From now on, the PB-530 Proxeo Ultra Piezo scaler and the Proxeo Twist Cordless System can be controlled using just a single wireless foot control. This not only makes it more convenient to operate, but also ensures more efficiency in working process.

All Proxeo Combi-Sets consist of:

Cordless Polishing System Proxeo Twist

- › PL-40 H handpiece drive
incl. handpiece sleeve
- › Foot control C-NW
- › Charger with adaptor
- › Handpiece holder

Control unit PB-530 with coolant tank

Switch-mode power supply

1.8 m supply hose

Cable (pairing/charging) for C-NW



Cordless Polishing System Proxeo Twist

- › PL-40 HW handpiece drive
- › PL-66 W
- › Foot control C-NW
- › Charger with adaptor
- › Handpiece holder

Control unit PB-530 with coolant tank

Switch-mode power supply

1.8 m supply hose

Cable (pairing/charging) for C-NW



Handpiece PB-5 L Q

Tips: 1UQ, 2UQ, 1PQ, 1IQ

incl. tip exchanger with torque limitation

Proxeo Combi-Sets:

Set PB-530, PB-5 L Q, PL-40 H

REF 90000298

3.615,-

Set PB-530, PB-5 L Q,

PL-40 HW, PL-66 W

REF 90000356

3.628,-



Handpiece PB-5 L

Tips: 1U, 2U, 1P, 1I

incl. tip exchanger with torque limitation

Proxeo Combi-Sets:

Set PB-530, PB-5 L, PL-40 H

REF 90000299

3.615,-

Set PB-530, PB-5 L,

PL-40 HW, PL-66 W

REF 90000354

3.628,-



Handpiece PB-5 L S

Tips: 1US, 2US, 3US, 1PS

incl. tip exchanger with torque limitation

Proxeo Combi-Sets:

Set PB-530, PB-5 L S, PL-40 H

REF 90000301

3.615,-

Set PB-530, PB-5 L S,

PL-40 HW, PL-66 W

REF 90000358

3.628,-



Implantmed SI-1023 / SI-1015



implantmed^{PLUS}

The W&H Implantmed offers the implantologist a drive unit for daily use

This surgical unit can be safely used for oral-surgery procedures in implantology and maxillo-facial surgery.

Implantmed Set, consists of:

- › Control unit (230 V or 120 V)
- › Motor with 1.8 m cable (EM-19/EM-19 LC)
- › Including 5 clips
- › Foot control S-N2 / S-NW
- › Stand
- › Universal support
- › Mains cable
- › disposable irrigation tubings



Foot control S-N2, motor without electrical contacts

SI-1023 (230 V)	
REF 90000163	3.523,-
SI-1015 (120 V)	
REF 90000167	3.523,-



Foot control S-N2, motor with electrical contacts

SI-1023 (230 V)	
REF 90000165	4.130,-
SI-1015 (120 V)	
REF 90000169	4.130,-



Foot control S-NW, motor without electrical contacts

SI-1023 (230 V)	
REF 90000164	3.948,-
SI-1015 (120 V)	
REF 90000168	3.948,-



Foot control S-NW, motor with electrical contacts

SI-1023 (230 V)	
REF 90000166	4.557,-
SI-1015 (120 V)	
REF 90000170	4.557,-



without foot control incl. CAN dongle, motor without electrical contacts

SI-1023 (230 V)	
REF 90000171	3.138,-
SI-1015 (120 V)	
REF 90000173	3.138,-



without foot control incl. CAN dongle, motor with electrical contacts

SI-1023 (230 V)	
REF 90000172	3.791,-
SI-1015 (120 V)	
REF 90000174	3.791,-

Implantmed Sets



EM-19 motor (without electrical contacts)

1.8 m cable with 5 clips	
REF 30185000	1.395,-

EM-19 LC motor (with electrical contacts)

1.8 m cable with 5 clips	
REF 30281000	2.006,-

EM-19 LC motor (with electrical contacts)

3.5 m cable with 10 clips	
REF 30281001	2.249,-



Implantmed SI-1023 (230 V)

REF 30288000	1.519,-
--------------	---------

Implantmed SI-1015 (120 V)

REF 30289000	1.519,-
--------------	---------

Oral surgery & Implantology

Implantmed Sets



transportation case for Implantmed Plus and Piezomed module
REF 07962790 **437,-**



foot control S-N2
REF 30285000 **705,-**



foot control S-NW with CAN dongle
REF 30264000 **1.130,-**



CAN dongle
REF 07759700 **267,-**



universal support
REF 07721800 **37,30**



Measuring probe with cable for W&H Ostell ISQ module
REF 07721100 **499,-**



SmartPeg mount 1pc
REF 07460300 **25,40**



Parts available after sale

Oral surgery & Implantology

Oral surgery & Implantology

Piezomed Modul Classic / Plus SA-435 M / SA-430 M

Explanation of Symbols

-  without light
-  thermo washer
disinfectable
-  sterilizable



The W&H Piezomed Module covers the cpl. Surgical workflow

A tailor-made solution for every user. Implantmed can be combined with the Piezomed module with a plug-and-play solution and covers several surgical applications.

Piezomed Plus module 1.8 m
consisting of:

- › Module
- › Handpiece SA-40 L (1.8m)
- › Power supply and main cable
- › Support and stand
- › Instrument changer
- › 6 pcs. disposable irrigation tubes

SA-435 M (1.8 m)
REF 90000350

4.961,-



Piezomed Plus module 3.5 m
consisting of:

- › Module
- › Handpiece SA-40 L (3.5 m)
- › Power supply and main cable
- › Support and stand
- › Instrument changer
- › 6 pcs. disposable irrigation tubes

SA-435 M (3.5 m)
REF 90000351

5.094,-



Piezomed Classic module
consisting of:

- › Module
- › Handpiece SA-40 (1.8m)
- › Power supply and main cable
- › Support and stand
- › Instrument changer
- › 6 pcs. disposable irrigation tubes

SA-430 M
REF 90000349

3.859,-



Piezomed Handpiece with
› 1.8 m cable
› LED Light and tip detection
› Instrument changer



SA- 40 L (1.8 m)
REF 30392000

1.610,-



Piezomed Handpiece with
› 3.5 m cable
› LED Light and tip detection
› Instrument changer



SA- 40 L (3.5 m)
REF 30392001

1.731,-



Piezomed Handpiece with
› 1.8 m cable
› No light and without tip detection
› Instrument changer



SA- 40 (1.8 m)
REF 30408000

1.323,-



Disposable irrigation tubes
with Y-switch 2,2 m (6pcs)
REF 08072750

68,40

Disposable irrigation tubes
with Y-switch 3,8 m (6pcs)
REF 08041710

79,50



transportation case for Implantmed Plus and Piezomed module
REF 07962790

437,-



instrument changer
REF 06276700

95,-







Oral surgery & Implantology

Oral surgery & Implantology

Surgical straight and contra-angle handpieces

Explanation of Symbols

-  with LED+ light
-  external spray
-  thermo washer disinfectable
-  sterilizable

with Mini LED+
and W&H
connection



Surgical straight and contra-angle handpieces



20:1, hexagon chucking system, press-button chuck system, for surgical burs and cutters with contra-angled shank Ø 2.35 mm (shank hardness >50 HRC, >520 HV), optionally available Kirschner/Meyer internal cooling system

WS-75 L
REF 30033000 1.420,-



1:1, press-button chuck system, for surgical burs and cutters with contra-angled shank Ø 2.35 mm

WS-56 L
REF 30040000 1.310,-



1:2.7, 45° head, triple spray, press-button chuck system, for surgical burs and cutters with FG shank Ø 1.6 mm

WS-91 L
REF 30049000 1.310,-



1:2.7, triple spray, press-button chuck system, for surgical burs and cutters with FG shank Ø 1.6 mm

WS-92 L
REF 30043000 1.310,-



1:1, straight, lever chuck system, for surgical burs and cutters Ø 2.35 mm (also system Stryker)

S-11 L
REF 30058000 1.409,-

Elcomed*

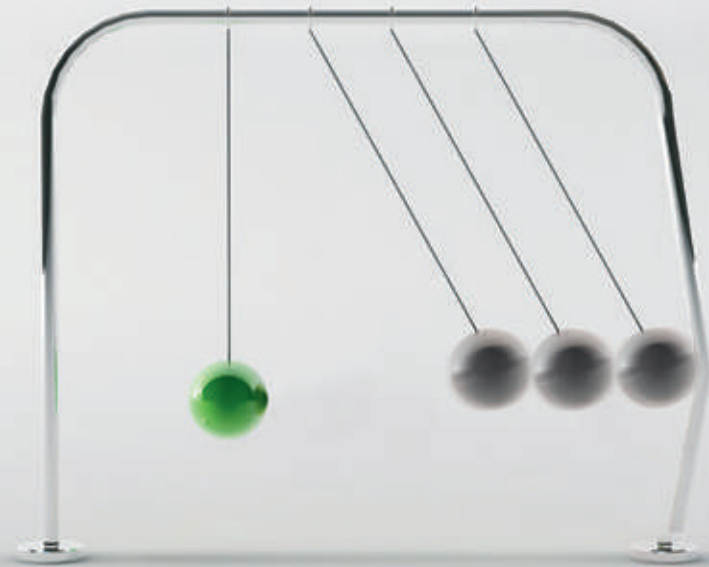

*Product discontinuation August 2023

Elcomed, consists of:

- › Control unit with or without documentation
- › (220 – 240 V or 100 – 130 V)
- › Variable foot control S-N1
- › Motor with 1.8 or 3.5 m cable and clips
- › Irrigation tubing set
- › Mains cable
- › Motor support
- › Stand
- › Locking pins
- › Additional equipment for control unit with documentation: USB Stick



SA-310 with documentation

motor with 1.8 m cable	
REF 15933100	5.329,-
motor with 3.5 m cable	
REF 15933101	5.455,-

SA-310 without documentation

motor with 1.8 m cable	
REF 15933102	4.948,-
motor with 3.5 m cable	
REF 15933103	5.075,-

motor 1.8 m cable with 5 clips
REF 05513400 **1.259,-**

motor 3.5 m cable with 10 clips
REF 06205800 **1.364,-**

**transportation case
Elcomed SA-310**
REF 07945930 **437,-**

**fuse
250 V – T1,6AH**
REF 06352200 **3,77**

USB stick
REF 06290700 **46,-**

Parts available after sale

Implantmed Classic SI-915 / SI-923



The W&H Implantmed Classic offers the implantologist a surgical unit for daily use. The ergonomic design and ease of use ensures fatigue-free operation.

Implantmed Classic Set, consisting of:

- › Control unit (230 V or 120 V)
- › Motor EM-19 with 1.8 m cable
- › Incl. 5 hose clips
- › Foot control S-N2
- › Irrigant support
- › Universal support
- › Mains cable
- › disposable coolant hoses



SI-923 (230 V)
REF 90000161

3.206,-

SI-915 (120 V)
REF 90000162

3.206,-

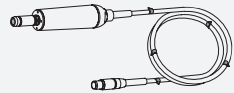

motor with 1.8 m cable incl. 5 clips
REF 06631600

1.137,-

Attention! Not compatible with Implantmed Classic.



EM-19 motor (without electrical contacts)
1.8 m cable with 5 clips
REF 30185000

1.395,-



foot control S-N2
REF 30285000

705,-

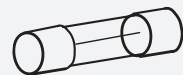

fuse T1,6 AH
REF 06352200

3,77



foot control S-NW with SPI dongle
REF 30264001

1.258,-

Attention! Not compatible with Implantmed Classic.



SPI dongle (Implantmed SI-923, SI-915 (2011), Elcomed SA-310, Piezomed SA-320)
REF 07795800

396,-

Attention! Not compatible with Implantmed Classic.



variable foot control (Elcomed SA-310, Implantmed SI-923, SI-915) S-N1
REF 06202400

669,-

Attention! Not compatible with Implantmed Classic.

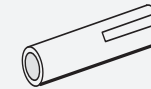

locking pin for motor
REF 04006800

8,10

Attention! Not compatible with Implantmed Classic.



transportation case Implantmed SI-923 / SI-915
REF 07948730

437,-

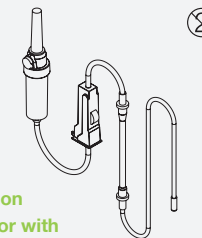

Disposable irrigation tubing set for motor with 1,8 m cable, 6pcs, 2,2 m
REF 04363600

63,20

Disposable irrigation tubing set for motor with 3,5 m cable, 6 pcs, 3,8 m
REF 04364100

74,50

Parts available after sale

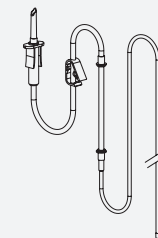

Sterilizable irrigation tubing set for motor with 1,8 m cable 1 pcs, 2,2 m
REF 04719400

87,-

Parts available after sale for Elcomed SA-200 only

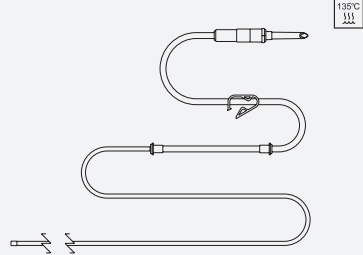

sterilizable irrigation tubing set 2.2 m, for motor with 1.8 m cable
 REF 04976700 **87,-**

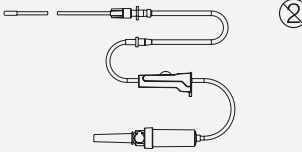

disposable irrigation tubing set, 6 set per carton, for motor with 2.2 m cable
 REF 04365300 **63,20**

disposable irrigation tubing set, 6 set per carton, for motor with 3.8 m cable
 REF 04365100 **74,50**



Disposable irrigation tubing set for motor with 1,8 m cable
 10 pcs, 2,2 m
 REF 00929300 **42,-**

Disposable irrigation tubing for motor with 3,5 m cable
 10 pcs, 3,8 m
 REF 00929400 **50,10**



fuse T1,25AH
 REF 06661800 **3,54**



Oral surgery & Implantology

Oral surgery & Implantology

Surgical straight and contra-angle handpieces

Explanation of Symbols

led+ with LED+ light

○ without light

⦿ external spray

☒ thermo washer disinfectable

135°C 111 sterilizable

with and without Mini LED+



Surgical straight and contra-angle handpieces



20:1, hexagon, press-button chuck system, for surgical burs and cutters with contra-angled shank Ø 2.35 mm, optionally available Kirschner/Meyer internal cooling system

WS-75 L G
REF 30032000

led+
1.571,-

WS-75
REF 30065000

○
1.325,-



1:1, press-button chuck system, for surgical burs and cutters with contra-angled shank Ø 2.35 mm

WS-56 L G
REF 30039000

led+
1.463,-

WS-56
REF 30038000

○
1.140,-



1:2.7, 45° head, triple spray, press-button chuck system, for surgical burs and cutters with FG shank Ø 1.6 mm

WS-91 L G
REF 30048000

led+
1.463,-

WS-91
REF 30047000

○
1.215,-



1:2.7, triple spray, press-button chuck system, for surgical burs and cutters with FG shank Ø 1.6 mm

WS-92 L G
REF 30042000

led+
1.463,-

WS-92
REF 30041000

○
1.215,-

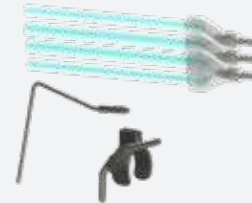

135°C 111 sterilizable

Kirschner Meyer internal cooling system set (WI-75) black
REF 08014692

68,90



20:1, hexagon, press-button chuck system, for surgical burs and cutters with contra-angled shank Ø 2.35 mm, optionally available Kirschner/Meyer internal cooling system

WS-75 E/KM (not dismantlable)
REF 10207550

○
1.056,-

Surgical straight and contra-angle handpieces

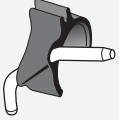

135°C
III

spray clip black with external tube holder for Kirschner/Meyer internal cooling system

3 pcs
REF 04757100 **40,20**



135°C
III

spray clip black without external tube holder

3 pcs
REF 05051000 **40,20**



135°C
III

spray clip green with external tube holder for Kirschner/Meyer internal cooling system

3 pcs, for left
REF 06946300 **39,40**

3 pcs, for right
REF 06948300 **39,40**



135°C
III

spray clip green without external tube holder

3 pcs, for left
REF 06948400 **39,40**

3 pcs, for right
REF 06949500 **39,40**



135°C
III

coolant tubing for internal cooling through the bur

REF 02610500 **21,90**



135°C
III

Y-manifold

3 pcs
REF 06016400 **38,70**

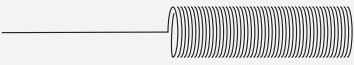

135°C
III

short nozzle cleaner

REF 02015101 **4,40**



135°C
III

Kirschner Meyer internal cooling system set (WS-75) green

REF 08014690 **68,90**

Surgical straight and contra-angle handpieces



135°C
III

1:1, straight, lever chuck system, for surgical burs and cutters Ø 2.35 mm (also system Stryker)

S-11 LG
REF 30057000 **1.562,-**

S-11
REF 30056000 **1.015,-**



135°C
III

1:1, angled, slim, lever chuck system, for surgical burs and cutters Ø 2.35 mm (also system Stryker)

S-9 LG
REF 30054000 **1.685,-**

S-9
REF 30053000 **1.314,-**



135°C
III

1:1, straight, lever chuck system, for surgical burs and cutters Ø 2.35 mm (also system Stryker)

S-15
REF 30060000 **1.189,-**



135°C
III

1:1, angled, slim, lever chuck system, for surgical burs and cutters Ø 2.35 mm

S-10
REF 30059000 **1.511,-**



135°C
III

1:2, angled, slim, lever chuck system, for surgical burs and cutters Ø 2.35 mm

S-12
REF 30061000 **1.511,-**



135°C
III

1:2, lever chuck system, for surgical burs and cutters, Ø 2.35 mm

S-16
REF 30411000 **1.496,-**



135°C
III

20:1, twist chuck system, for zygoma burs, surgical burs and cutters, Ø 2.35 mm

SZ-75
REF 30095000 **2.210,-**



coolant tube, movable
for S-9, S-9 L G, S-11, S-11 L G, S-16
REF 06879500 **24,20**



coolant tube, movable
for S-10, S-12
REF 06903200 **24,20**



coolant tube, movable
for S-15
REF 07226900 **48,70**









coolant tube Zygoma
REF 08030410 **74,50**

Parts available after sale



Surgical saw handpieces

Explanation of Symbols

-  reciprocating
-  oscillating
-  sagittal
-  without light
-  external spray
-  thermo washer disinfectable
-  sterilizable



The saw handpieces have been specially designed for conversion osteotomies and bone harvesting. Even after many years of use at maximum speed a high performance is still guaranteed.

Surgical saw handpieces



3.25:1, with 2 reciprocating saw blades each, R-15, R-20 and R-30

S-8 R reciprocating
REF 10100801 **1.633,-**



3.4:1, with 2 oscillating saw blades each, O-8 and O-15

S-8 O oscillating
REF 10100802 **2.021,-**



3.25:1, with 2 sagittal saw blades each, S-6 and S-10

S-8 S sagittal
REF 10100803 **1.892,-**



coolant tubing for S-8 R, S-8 S
REF 04870800 **74,50**



coolant tubing for S-8 O
REF 04871000 **79,50**



spanner to change the saw blades
REF 04740200 **3,89**

Surgical saw handpieces



reciprocating, crosswise, forward/reverse cutting direction, for saw handpiece S-8 R

R-15, length approx. 15 mm
1 pc REF 04726000 **18,10**
5 pcs REF 04800100 **81,-**

R-20, length approx. 20 mm
1 pc REF 04725900 **18,10**
5 pcs REF 04800000 **81,-**

R-30, length approx. 30 mm
1 pc REF 04725700 **18,10**
5 pcs REF 04799900 **81,-**



oscillating, cutting direction 90° to the axis, depth gauge on the saw blade (2.5 mm gradations), for saw handpiece S-8 O

O-8, width approx. 8 mm
REF 04800500 **26,60**

O-15, width approx. 15 mm
REF 04800400 **26,60**



sagittal, cutting direction parallel to the axis, depth gauge on the saw blade (2.5 mm gradations), for saw handpiece S-8 S

S-6, width approx. 6 mm
1 pc REF 04726200 **18,10**
5 pcs REF 04800300 **81,-**

S-10, width approx. 10 mm
1 pc REF 04726100 **18,10**
5 pcs REF 04800200 **81,-**

Saw blades

Piezomed



piezomed

Piezomed facilitates the surgeon's work: thanks to innovative Ultrasound technology, only bone substance is resected with high precision. The surrounding soft tissue remains uninjured. A noticeable relief for the patient: less pain, quicker healing!

Piezomed, consists of:

- › Control unit (100 – 130 V / 220 – 240 V)
- › Foot control S-N1 / S-NW
- › Handpiece with 1.8 m cable or
- › Handpiece with 3.5 m cable and clips
- › Irrigation tubing set
- › Mains cable
- › Motor support
- › Stand
- › Instrument changer
- › Sterilization Cassette
- › Instrument kit „Bone“

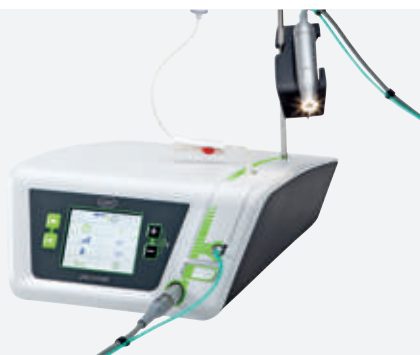

SA-320 with handpiece 1,8 m cable, foot control S-N1
REF 30078000



7.835,-

SA-320 with handpiece 3,5 m cable, foot control S-N1
REF 30078001



7.958,-



SA-320 with handpiece 1,8m cable, foot control S-NW, SPI Dongle
REF 30078005

8.283,-

SA-320 with handpiece 1,8 m cable, without foot control, SPI Dongle
REF 30078004

7.437,-

SA-320 with handpiece 1,8 m cable, without foot control, without Instrumentkit Bone, without sterilisation cassette
REF 30078003

6.006,-

handpiece
1.8 m cable incl. 5 clips
REF 06985000

2.082,-

handpiece
3.5 m cable incl. 10 clips
REF 07159200

2.209,-

foot control S-N1
REF 07004400

657,-

handle for foot control S-N1, S-N2, S-NW
REF 04653500

7,50

foot control S-NW with SPI dongle
REF 30264001

1.258,-

SPI dongle (Implantmed SI-923, SI-915 (2011), Elcomed SA-310, Piezomed SA-320)
REF 07795800

396,-

LED-Socket
REF 06205600

222,-

fuse T1,25AH
REF 06661800

3,54

transportation case Piezomed SA-320
REF 07945930

437,-

Cassette for Piezomed
REF 07172900

222,-

Parts available after sale



Disposable irrigation tubing set for motor with 1,8 m cable, 6 pcs, 2,2 m
REF 04363600 **63,20**

Disposable irrigation tubing set for motor with 3,5 m cable, 6 pcs, 3,8 m
REF 04364100 **74,50**



Sterilizable irrigation tubing set for motor with 1,8 m cable, 1 pcs, 2,2 m
REF 04719400 **87,-**



instrument stand
REF 07134900 **77,-**



instrument kit „Bone“
consists of instruments:
B1, B2R, B2L, B3, B4, B5
REF 07173100 **1.041,-**



instrument kit Sinus „SPECIAL“
consists of instruments:
S1, S2, S3, S4, S5
REF 07173200 **731,-**



instrument kit „Endo“
consists of instruments:
R1D, R2RD, R2LD, R3D, R4RD, R4LD
REF 07173300 **817,-**



instrument kit „Paro“
consists of instruments:
P1, P2RD, P2LD
REF 07173400 **459,-**



instrument kit „EX“
consists of instruments:
EX1, EX2
REF 07173500 **322,-**



Instrument kit „Implant/Crestal P“
consists of instruments:
I1, I2P, I3P, I4P, Z25P, Z35P
REF 07997110 **1.428,-**



Instrument kit „Implant/Crestal A“
consists of instruments:
I1, I2A, I3A, I4A, Z25P, Z35P
REF 07997090 **1.428,-**



Fine-toothed instrument for fine cuts, with little bone loss when harvesting bone blocks.

instrument B1
REF 05530100 **186,-**



Fine-toothed instrument for horizontal cuts with little bone loss in hard-to-reach areas. Right-curved models available.

instrument B2R
REF 06958600 **186,-**



Fine-toothed instrument for horizontal cuts with little bone loss in hard-to-reach areas. Left-curved models available.

instrument B2L
REF 05544400 **186,-**



Sharp instrument for modelling and contouring the bone surface, as well as for collecting bone chips.

instrument B3
REF 05542100 **162,-**



Sharp chisel for splitting the alveolar ridge.

instrument B4
REF 05543800 **162,-**



Sharp scraper for collecting bone chips and detaching bone flaps.

instrument B5
REF 05534500 **162,-**



Special saws for fine and deep cuts in record time. Also for separating tooth roots and for root-tip resections.

instrument B6
REF 07022500 **211,-**



Special saws for fine and deep cuts in record time. Also for separating tooth roots and for root-tip resections.

instrument B7
REF 07022600 **211,-**



Diamond-coated instrument for preparation of a bone flap for lateral sinus floor augmentation and for crown edge extensions.

instrument S1
REF 05542900 **162,-**



Instrument with diamond-coated ball for preparation of a bone flap for lateral sinus floor augmentation and for crown edge extensions.

instrument S2
REF 05534700 **162,-**



Instrument for gentle detachment of the Schneiderian membrane from the bone. The coolant film protects the Schneiderian membrane by means of three coolant openings.

instrument S3
REF 05508200 **134,-**



Instrument with rounded edges for atraumatic detachment of the Schneiderian membrane.

instrument S4
REF 05542300 **134,-**



Instrument with rounded edges for atraumatic detachment of the Schneiderian membrane.

instrument S5
REF 05542800 **134,-**



Straight, diamond-coated instrument for retrograde root canal preparation.

instrument R1D
REF 05975200 **134,-**



Slightly right-curved, diamond-coated instrument for retrograde root canal preparation.

instrument R2RD
REF 05991000 **134,-**



Slightly left-curved, diamond-coated instrument for retrograde root canal preparation.

instrument R2LD
REF 05999400 **134,-**



Angled, diamond-coated instrument for retrograde root canal preparation.

instrument R3D
REF 05998800

134,-



Strongly right-curved, diamond-coated instrument for retrograde root canal preparation.

instrument R4RD
REF 06005000

134,-



Strongly left-curved, diamond-coated instrument for retrograde root canal preparation.

instrument R4LD
REF 06004700

134,-



For removing concretions in the subgingival region. Ideal for treatment of deep, periodontal pockets.

instrument P1
REF 06067700

134,-



Right-curved, diamond-coated tip for periodontal debridement. Especially suitable for open root planing.

instrument P2RD
REF 06061700

162,-



Left-curved, diamond-coated tip for periodontal debridement. Especially suitable for open root planing.

instrument P2LD
REF 06061800

162,-



Instrument for atraumatic tooth extraction to preserve the alveolar bone.

instrument EX1
REF 06069300

162,-



Instrument for atraumatic tooth extraction to preserve the alveolar bone.

instrument EX2
REF 06071100

162,-



Diamond-coated instrument with depth marks for pilot preparation with the correct axial alignment.

instrument I1
REF 07786800

179,-



Diamond-coated instrument for expansion of the pilot hole (Ø 2.5 mm) and for lifting the Schneiderian membrane using a cooling medium.

instrument Z25P
REF 07785600

202,-



Instruments for gradual preparation of the implant bed (2 to 3 mm) up to the desired depth. A = anterior region

instrument I2A
REF 07797800

310,-



Instruments for gradual preparation of the implant bed (2 to 3 mm) up to the desired depth. P = posterior region

instrument I2P
REF 07788800

310,-



Instruments for gradual preparation of the implant bed (2 to 3 mm) up to the desired depth. A = anterior region

instrument I3A
REF 07885600

322,-



Instruments for gradual preparation of the implant bed (2 to 3 mm) up to the desired depth. P = posterior region

instrument I3P
REF 07887000

322,-



Diamond-coated instrument for expansion of the pilot hole (Ø 3.5 mm) and for lifting the Schneiderian membrane using a cooling medium.

instrument Z35P
REF 07980600

215,-



Instruments for preparation of the implant bed (4 mm) up to the desired depth. A = anterior region

instrument I4A
REF 07889400

334,-



Instruments for preparation of the implant bed (4 mm) up to the desired depth.
P = posterior region

instrument I4P
REF 07889500 **334,-**



instrument changer
REF 06276700 **95,-**

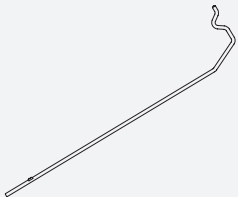

stand
REF 04005900 **24,70**



motor support
REF 06177800 **38,-**



clips 5pcs for Elcomed SA-310, Piezomed SA-320, Implantmed Plus and Implantmed Classic
REF 06290600 **8,30**

clips 5 pcs for Implantmed SI-923 / SI-915
REF 04019000 **8,30**



handle for foot controls
REF 04653500 **7,50**



nozzle cleaner
REF 00636901 **5,30**



Cassette for Piezomed
REF 07172900 **222,-**



› Your W&H control units in one compact location
› Space-saving
› Mobile
› Dimensions (height x width x depth): 935 x 500 x 450 mm

Surgical trolley with 3 sockets (European style)
REF 07962870 **1.108,-**

Roto Quick couplings

Explanation of Symbols

led with LED light

with light

without light

integrated spray

sterilizable



The Roto Quick system coupling is a multi-faceted system interface, which connects any standardized turbine tubing to any W&H turbine or air scaler with Roto Quick connection.



standard 6-hole connection

RQ-24
REF 10402400

310,-



standard 6-hole connection, adjustable spray

RQ-34
REF 10403400

355,-



Borden 2(3)-hole connection

RQ-03
REF 10400300

189,-



standard 4-hole connection

RQ-04
REF 10400400

189,-



standard 4-hole connection, adjustable spray

RQ-14
REF 10401400

257,-

Quick couplings with generator for Alegra turbine handpieces TE-97/98 LQ



Borden 2-hole connection, generator and water filter with resuction stop

RQ-53
REF 10405300

298,-



standard 4-hole connection, generator and water filter with resuction stop

RQ-54
REF 10405400

298,-

Quick couplings for Synea Fusion turbine handpiece TG-97/98 LW



standard 6-hole connection, for Synea Fusion turbine handpiece TG-97/98 LW

RA-24
REF 10402424

310,-



5-hole connection (with light), glass rod, for Synea Fusion turbine handpiece TG-97/98 LW

RA-25
REF 10402525

298,-

Coupling with LED light for KaVo Multiflex® connection



standard 6-hole connection, adjustable spray

RM-34 LED
REF 10403410

569,-

Parts available after sale



O-ring set
REF 07508900

6,60

Quick couplings

Drive

Drive

Air motors

Explanation of Symbols

-  with LED light
-  with light (halogen)
-  without light
-  integrated spray
-  external spray
-  without spray
-  thermo washer disinfectable
-  sterilizable



*can be used with Roto Quick couplings with light: RQ-24 / RQ-34 – see page 118

**can be used with Roto Quick couplings: RQ-24 / RQ-34 / RQ-14 / RQ-03 / RQ-04 – see page 118



Roto Quick connection for contra-angle and straight handpieces with light for RQ-34 or RQ-24*

AM-25 LT
REF 10002500 1.084,-



standard 6-hole connection, LED light, for contra-angle and straight handpieces with glass rod

AM-25 L RM
REF 30102000 1.031,-



Roto-Quick connection for contra-angle and straight handpieces without light for RQ-14, RQ-03 or RQ-04**

AM-25 A
REF 10002501 710,-



standard 4-hole fix connection, for contra-angle and straight handpieces without light

AM-25 A RM
REF 30103000 710,-

With integrated spray sleeve outer diameter of 20mm



Borden 2(3)-hole fix connection, for contra-angle and straight handpieces without light

AM-25 A BC
REF 30104000 710,-

With external spray sleeve outer diameter of 20mm



standard 4-hole fix connection, for contra-angle and straight handpieces without light

AM-25 E RM
REF 30105000 **500,-**



Borden 2(3)-hole fix connection, for contra-angle and straight handpieces without light

AM-25 E BC
REF 30111000 **500,-**



Roto Quick connection, for contra-angle and straight handpieces without light, for Roto Quick couplings RQ-03, RQ-04 and RQ-14

AM-25 RQ
REF 30399000 **428,-**



standard 4-hole fix connection, for contra-angle and straight handpieces without light

AM-25 RM
REF 30108000 **428,-**



Borden 2(3)-hole fix connection, for contra-angle and straight handpieces without light

AM-25 BC
REF 30112000 **428,-**

Without spray sleeve outer diameter of 20mm

With external spray sleeve outer diameter of 18mm



standard 4-hole fix connection, for contra-angle and straight handpieces without light

AM-20 E RM
REF 30107000 **470,-**



Borden 2(3)-hole fix connection, for contra-angle and straight handpieces without light

AM-20 E BC
REF 30109000 **470,-**



Roto Quick connection, for contra-angle and straight handpieces without light, for Roto Quick couplings RQ-03, RQ-04 and RQ-14

AM-20 RQ
REF 30400000 **394,-**



standard 4-hole fix connection, for contra-angle and straight handpieces without light

AM-20 RM
REF 30106000 **394,-**



Borden 2(3)-hole fix connection, for contra-angle and straight handpieces without light

AM-20 BC
REF 30113000 **394,-**

Without spray sleeve outer diameter of 18mm



O-ring for air motors
AM-25 L RM, AM-25 A RM, AM-25 A BC
3 pcs
REF 01862300 **6,60**

Parts available after sale



LED-ring for AM-25 L RM
REF 07389100 **118,-**

Air Motors compatible with Midwest handpiece connection*



Roto Quick connection, for contra-angle and straight handpieces with Midwest handpiece connection, for RQ-03 or RQ-04

AM-20 MW RQ
REF 30402000 **676,-**



standard 4-hole fix connection, for contra-angle and straight handpieces with Midwest handpiece connection

AM-20 MW RM
REF 30115001 **982,-**



Roto Quick connection, for contra-angle and straight handpieces with Midwest handpiece connection, 4:1 speed decreasing, for RQ-03 or RQ-04

AM-05 MW RQ
REF 30404000 **778,-**



standard 4-hole fix connection, for contra-angle and straight handpieces with Midwest handpiece connection, 4:1 speed decreasing

AM-05 MW RM
REF 30220001 **982,-**

Air Motors compatible with Star Dental handpiece connection**



Roto Quick connection, for contra-angle and straight handpieces with Star Dental handpiece connection, for RQ-03 or RQ-04

AM-20 SD RQ
REF 30401000 **676,-**



standard 4-hole fix connection, for contra-angle and straight handpieces with Star Dental handpiece connection

AM-20 SD RM
REF 30114001 **982,-**



Roto Quick connection, for contra-angle and straight handpieces with Star Dental handpiece connection, 4:1 speed decreasing, for RQ-03 or RQ-04

AM-05 SD RQ
REF 30403000 **778,-**



standard 4-hole fix connection, for contra-angle and straight handpieces with Star Dental handpiece connection, 4:1 speed decreasing

AM-05 SD RM
REF 30219001 **982,-**

* W&H handpieces with Midwest handpiece connection: WE-56 T MW, WE-57 T MW, HE-43 T MW (see page 25)

** W&H handpieces with Star Dental handpiece connection: WE-56 T SD, WE-57 T SD, HE-43 T SD (see page 25)

Add-on



- › AF-100 control unit basic
60,000 – 320,000 rpm
- › Power supply
100 – 240 V
- › Air supply hose
Ø 6 mm
- › RQ-24
- › RG-97 L (LED+)

Add-on AF-100
REF 90000143

3.334,-



Add-on AF-100

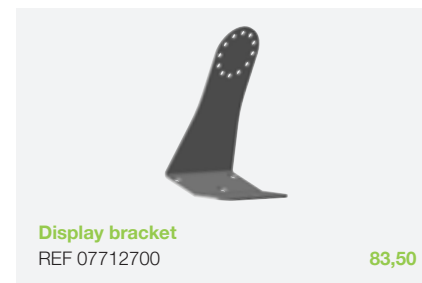

Accessories for Add-on

Built-in Sets analogue



- › AC-1.0 Advanced Air Controller + AD-1.0 Analog-digital converter
- › Supply hose VA-6
- › Air supply hose Ø 8 mm
- › 2 connection sets (pneumatic and electric)
- › RQ-24
- › RG-97 L
- › Display D-2.0 A



Advanced Air RG-97 L with display basic
REF 90000141 3.395,-

W&H drive solutions are now available as Built-in Solutions for dental units

United under the term Built-in Solutions, W&H offers a range of drive solutions that can be integrated in dental units.

Electric motor EM-12 L

Explanation of Symbols

-  with light
-  integrated spray
-  sterilizable



Add-on MF-100 electric motor

- › MF-100 control unit basic 2,000 – 40,000 rpm
- › Power supply
- › EM-12 L electric motor max. 3 Ncm torque

Add-on MF-100
REF 90000144

2.203,-



Tray
REF 07944590

117,-



Add-on support
REF 07842200

107,-

Accessories for Add-on



Display bracket
REF 07712700

83,50

Drive

Built-in Solutions



- › MC-1.0 E motor controller analogue
- › VE-10 hose
- › EM-12 L electric motor
- › 2 connection sets (pneumatic and electric)

EM-12 L electric motor with display basic
REF 90000139 **2.983,-**

- › MC-1.0 motor controller analogue
- › VE-10 hose
- › EM-12 L electric motor
- › 2 connection sets (pneumatic and electric)

EM-12 L electric motor with control knob
REF 90000138 **1.875,-**

- › MC-1.0 motor controller analogue
- › VE-10 hose
- › EM-12 L electric motor
- › 2 connection sets (pneumatic and electric)

EM-12 L electric motor with display basic
REF 90000245 **2.377,-**





- › MC-2.0 motor controller analogue
- › 2x VE-10 hose
- › 2x EM-12 L electric motor
- › 2 connection sets (pneumatic and electric)

Dual EM-12 L electric motor with display basic
REF 90000224 **4.167,-**

q-link

Ultrasonic scaler

Explanation of Symbols

-  with light
-  without light
-  integrated spray
-  thermo washer disinfected
-  sterilizable



Built-in SETS analogue



- › PC-1.0 piezo controller analogue
- › VP-5 supply hose
- › PB-5 L handpiece with 5x ring LED
- › Electrical connection set
- › Control knob
- › incl. tips:
- › **PB-5 L:** 1x 1U, 1x 2U, 1x 1P
- › **PB-5 L Q:** 1x 1UQ, 1x 2UQ, 1x 1PQ
- › **PB-5 L S:** 1x 1US, 1x 2US, 1x 1PS

Piezo Scaler PB-5 L
(with W&H / EMS / Mectron
standard thread)

REF 90000251 **1.363,-**

Piezo Scaler PB-5 L Q
(with W&H Q-link - quick
connection)

REF 90000252 **1.363,-**

Piezo Scaler PB-5 L S
(with W&H/Satelec/NSK thread)

REF 90000294 **1.363,-**



- › PC-1.0 piezo controller analogue
- › Supply hose
- › PB-3 handpiece
- › VP-3 supply hose
- › Electrical connection set
- › Control knob
- › incl. tips
- › PB-3: 1x 1U, 1x 1P
- › PB-3 S: 1x 1US, 1x 1PS

Piezo scaler PB-3
(with W&H / EMS / Mectron
standard thread)

REF 90000149 **905,-**

Piezo scaler PB-3 S
(with W&H/Satelec/NSK thread)

REF 90000302 **905,-**



Scope of application depends on Ultrasonic tips used.
All scaler tips with tip exchanger with torque limitation.



Thermal washer disinfector



Teon is a highly efficient thermal washer disinfector.



Teon, consists of:
 Teon is available without interior, so you can tailor the device exactly to your needs. For more information, see the accessories list.

ZER (Germany, Austria, Netherlands, Belgium, France, Switzerland, Italy, Slovenia, Croatia)
 REF 19860010

SER (Spain, Portugal)
 REF 19860020

OER (Hungary)
 REF 19860030

NER (Denmark, Finland, Norway, Sweden)
 REF 19860060

GB (Great Britain, Ireland)
 REF 19860110

7.284,-

teon +

Thermal washer disinfector



Teon +, the premium W&H thermal washer disinfector, ensures the most demanding clinics an excellent automatic cleaning system for instruments, including handpieces.



Teon +, consists of:

Complete your Teon + with the interior you really need. The device is sold empty, but can be equipped to your individual needs. For more information, see the accessories list.

ZER (Germany, Austria, Netherlands, Belgium, France, Switzerland, Italy, Slovenia, Croatia)

REF 19870010

NER (Denmark, Finland, Norway, Sweden)

REF 19870060

GB (Great Britain, Ireland)

REF 19870110

11.172,-

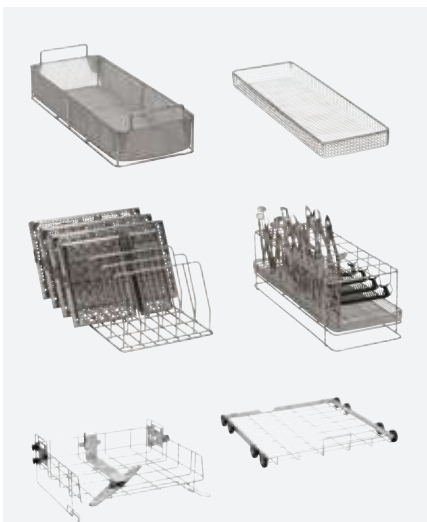

Accessories package includes the perfect range of basic equipment.

Starter pack:

- › A102 Upper basket
- › E430/1 Insert 1/3 mesh tray
- › A151 Lower basket/open front
- › E379 Insert 1/2 mesh tray
- › E337/1 Insert 2/5
- › E523 Insert 1/2

REF 19721439 **2.189,-**

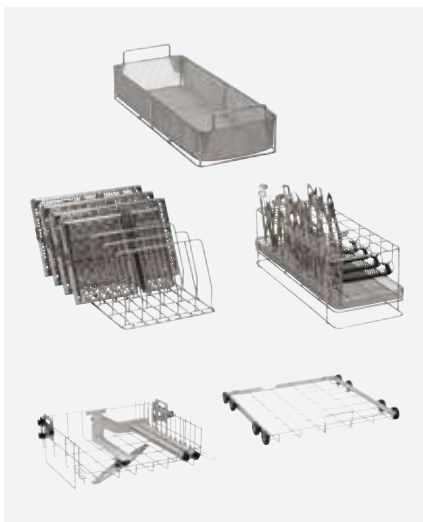

Accessories package complemented by an additional equipment perfectly and particularly suitable for handpieces.

Injector pack:

- › A151 Lower basket/open front
- › E379 Insert 1/2 mesh tray
- › E337/1 Insert 2/5
- › E523 Insert 1/2
- › A105/1 Upper basket/injectors unit
- › A836 Dental nozzle set

REF 19721440 **2.601,-**

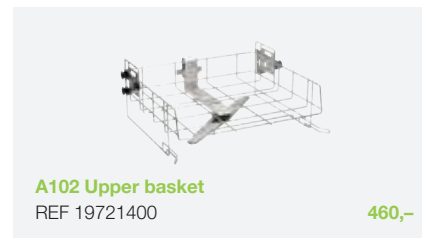

A102 Upper basket
REF 19721400 **460,-**



A105/1 Upper basket/injectors unit
REF 19721455 **741,-**

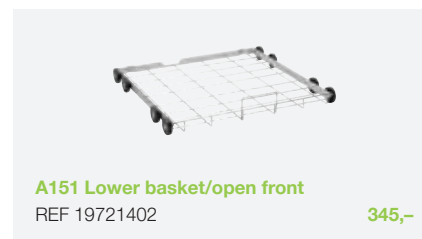

A151 Lower basket/open front
REF 19721402 **345,-**



XKM RS232 10 Med Serial module
REF 19721432 **177,-**



XKM 3000L Med Ethernet module
REF 19721433 **277,-**



A801 Adapter
REF 19721405 **38,10**

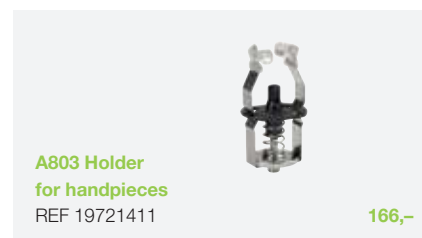

A803 Holder for handpieces
REF 19721411 **166,-**

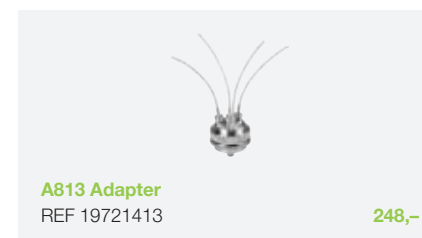

A813 Adapter
REF 19721413 **248,-**



Adaptor scaler tips
REF 06894700
Adaptor scaler tips
REF 06895000 **107,-**

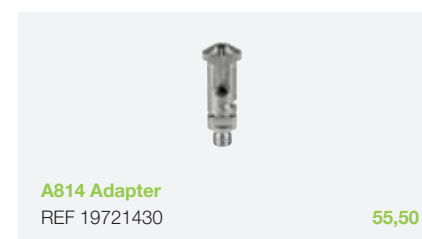









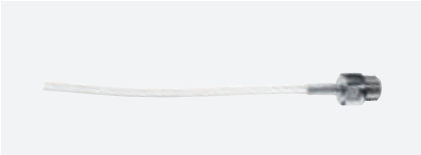









A814 Adapter
REF 19721430 **55,50**

Parts available after sale

Sterilization, Hygiene & Maintenance

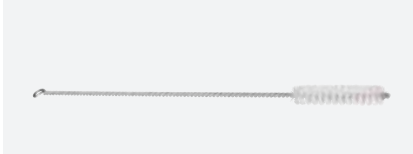
Sterilization, Hygiene & Maintenance

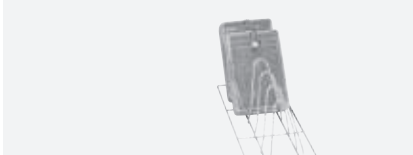
 <p>A815 Nozzle REF 19721414</p> <p>68,30</p>	 <p>A836 dental nozzle set REF 19721451</p> <p>329,-</p>
 <p>A832 Injector nozzle REF 19721457</p> <p>22,70</p>	 <p>A816 Injector nozzle REF 19721459</p> <p>32,90</p>
 <p>A834 Injector nozzle REF 19721458</p> <p>46,40</p>	 <p>A819 Irrigation sleeve REF 19721462</p> <p>94,50</p>
 <p>A817 Irrigation sleeve REF 19721460</p> <p>28,40</p>	 <p>E336 Irrigation sleeve REF 19721456</p> <p>38,60</p>
 <p>A818 Caps for sleeve REF 19721461</p> <p>83,-</p>	 <p>E476 Adapter REF 19721425</p> <p>103,-</p>

 <p>ADS1 Adapter silicone REF 19721408</p> <p>34,80</p>	 <p>ADS2 Adapter silicone REF 19721409</p> <p>34,80</p>
 <p>ADS3 Adapter silicone REF 19721410</p> <p>34,80</p>	 <p>AUF1 Adapter REF 19721406</p> <p>159,-</p>
 <p>A800 Central filter REF 19721404</p> <p>402,-</p>	 <p>A804 Cleaning brush REF 19721412</p> <p>402,-</p>
 <p>E130 Insert 1/2 for 10 trays REF 19721415</p> <p>159,-</p>	 <p>E131/1 Insert REF 19721416</p> <p>151,-</p>
 <p>E198 Insert 1/2 REF 19721419</p> <p>132,-</p>	 <p>E146 Insert 1/6 REF 19721417</p> <p>246,-</p>

Sterilization, Hygiene & Maintenance

Sterilization, Hygiene & Maintenance



E523 Insert 1/2
REF 19721429 **272,-**



E339/1 Insert
REF 19721437 **272,-**



E197 Insert 1/6 mesh tray
REF 19721418 **221,-**



E337/1 Insert 2/5
REF 19721420 **623,-**



E363 Insert 1/6 mesh tray
REF 19721421 **413,-**



E468 Insert 1/4 mesh tray w/lid
REF 19721465 **279,-**



E379 Insert 1/2 mesh tray
REF 19721422 **312,-**

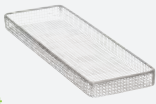

E430/1 Insert 1/3 mesh tray
REF 19721423 **177,-**



E378 Insert 1/1 mesh tray
REF 19721464 **401,-**



E147/1 Insert 1/2
REF 19721463 **93,-**



E473/2 Insert
REF 19721424 **116,-**



E520 Insert
REF 19721426 **62,40**



E521/2 Insert
REF 19721427 **134,-**



E522/1 Insert
REF 19721428 **208,-**



DOS K85/1 200-240V 50Hz
REF 19721435 **651,-**
DOS K85/1 200-240V 60Hz
REF 19721443 **689,-**



DOS K85/1 NER
REF 19721442 **689,-**



UG 30-60/60-85 Base plinth
REF 19721438 **638,-**

bepro

Coming soon

Cleaning and Disinfectant agents for

- › Surfaces
- › Instruments
- › Suction Systems
- › Automated Reprocessing
- › Hand Care



W&H adaptor kit



W&H adaptor kit for washer disinfectors consists of:



- › Adaptor scaler tips (piezo) (3 pcs)
- › Adaptor scaler tips (air scaler) (3 pcs)
- › Intermediate adaptor (3 pcs)
- › Silicone hose (10 pcs)

REF 07233500

265,-

W&H adaptor kit for washer disinfectors

The W&H adapter set was specially developed for the mechanical reprocessing of accessories and small components such as scaler tips, coolant tubes, Y-manifolds and spray clips with corresponding internal lumen.

adaptor scaler tips (piezo) 3 pcs
REF 06895000 **107,-**

intermediate adaptor 3 pcs
REF 07149200 **88,50**

adaptor scaler tips (air scaler) 3 pcs
REF 06894700 **107,-**

silicone hoses 10 pcs
REF 01525000 **49,40**

Parts available after sale

Sterilization, Hygiene & Maintenance

Assistina Twin with Quick Connect by W&H



**Oil service
without waiting.**

The Assistina Twin with Quick Connect by W&H is unique among maintenance devices: with its innovative dual-chamber system, record time lubrication and the environmentally friendly Care Set, it impresses all along the line.

Assistina Twin with Quick Connect by W&H, consists of:

- › REF 02697000 Air supply hose 2 m
- › REF 07477500 Power supply unit
- › REF 07484000 Twin Care Set

Assistina Twin MB-302

REF 30310000 **2.847,-**

Assistina Twin MB-302 +

2 Quick ISO adaptors
REF 30310001 **2.957,-**

Assistina Twin MB-302 +

2 Quick RM adaptors
REF 30310002 **2.957,-**

Assistina Twin MB-302 +

1 Quick ISO +
1 Quick RM adaptors
REF 30310003 **2.957,-**



Parts available after sale



Sliding window
REF 07477200 **71,50**



Cartridge compartment cover
REF 07479500 **61,80**



Filter compartment cover
REF 07479300 **61,80**



Power supply unit
REF 07477500 **176,-**

Accessories

Twin Care Set, consists of:

- › W&H Activefluid, MC-302
- › W&H Service Oil F1, MD-302
- › HEPA filter

Twin Care Set
REF 07484000 **118,-**



Assistina One



Speed up maintenance operation

The entire lubrication and spray channel cleaning process only takes 18 seconds, making the Assistina One the fastest maintenance solution in its class. Together with Quick Connect by W&H and convenient cartridge management, the Assistina One is a modern maintenance solution for dental practices with high standards in handpiece care.

Assistina ONE with Quick Connect by W&H, consists of:

- › REF 02697000 Air supply hose 2 m
- › REF 08064970 One Care Set

Assistina ONE + 1 Quick ISO adaptor

REF 30398001 **1.515,-**

Assistina ONE + 1 Quick RM adaptor

REF 30398002 **1.515,-**

Assistina ONE + 1 Quick RM + 1 Quick ISO adaptors

REF 30398003 **1.565,-**



Rotating window
REF 08029230

143,-



Filter compartment cover
REF 08035870

11,60

ONE Care Set, consists of:

- › W&H Activefluid, MC-302
- › W&H Service Oil F1, MD-302
- › HEPA filter

ONE Care Set
REF 08064970

118,-



Assistina 301 plus



Maintenance unit for automatic internal cleaning of spray channels and lubrication of straight and contra-angle handpieces, turbine handpieces, air motors, air scalers, as well as W&H surgical straight and contra-angle handpieces.

Assistina 301 plus
with base adaptor REF 02685000
 REF 00030140 **1.407,-**

- set Assistina, consists of:**
- › REF 00030140 Assistina 301 plus
 - › REF 02680500 cleaning and lubricating set
 - › REF 02685000 base adaptor

REF 00030125 **1.485,-**



W&H Service Oil F1
MD-500 (oil bottle, 500 ml)
 REF 02675910 **62,90**



W&H cleaning liquid
MC-1000 (1000 ml)
 REF 02680200 **33,30**



cleaning and lubricating set, consists of:

- › MD-500 W&H Service Oil F1
- › MC-1000 W&H cleaning liquid

REF 02680500 **96,-**



fleece for Assistina 301 plus
20 pcs
 REF 02694500 **19,95**



filter pack
for Assistina 301 plus
 REF 02670500 **51,90**



Air connection hose 2 m
for Assistina Twin, One and 301 plus
 REF 02697000 **92,50**



Air filter for Assistina Twin, One and 301 plus
 REF 02675200 **19,50**



Waste drawer for Assistina 3x3 and 3x2
 REF 06692500 **88,50**



Air connection hose 2 m
for Assistina 3x3 and 3x2
 REF 06700100 **69,30**



Cover – Assistina 3x3
 REF 06691900 **201,-**
Cover – Assistina 3x2
 REF 06947500 **201,-**



External cleaning ring
for Assistina 3x3
 REF 06692700 **240,-**



for Assistina 3x3 and 3x2

W&H Activefluid, MC-1100
1 cartridge
 REF 06691600 **25,10**
W&H Activefluid, MC-1100
1 carton (6 cartridges)
 REF 06872300 **151,-**



for Assistina 3x3 and 3x2

W&H Service Oil F1, MD-200
1 cartridge
 REF 06691500 **31,50**
W&H Service Oil F1, MD-200
1 carton (4 cartridges)
 REF 06872200 **126,-**



Assistina adaptors

Adaptors for turbine handpieces



**for all W&H products
with Roto Quick system**
REF 02690400 **189,-**



**for turbine handpieces
with Multiflex® connection**
REF 04713200 **105,-**



for Sirona T1, T2, T3
REF 02692000 **200,-**



**adaptor Assistina Borden for
turbine handpieces**
REF 07014500 **159,-**



**Borden 2/3-hole adaptor for turbines
with a fixed connection**
REF 02083500 **92,50**



for Sirona T1 Classic
REF 02691000 **203,-**



**for W&H handpiece/
contra-angle head**
REF 05204600 **172,-**

Adaptors for straight and contra-angle handpieces



**for KAVO contra-angles
with removable heads**
REF 02679000 **114,-**



**for FG chuck system (W&H, Sirona)
for contra-angle and straight handpieces**
REF 02693000* **98,50**

Assistina adaptors

Assistina Twin and One adaptors



Quick ISO adaptor
REF 06422600 **186,-**



Quick RM adaptor
REF 06395100 **97,50**

Assistina 301 Plus adaptor



base adaptor included in the Assistina
base kit, for turbine handpieces or
adaptors with 4-hole (with or without light)

base adaptor
REF 02685000 **65,70**

Assistina 3x3, 3x2 adaptor



RM/ISO adaptor
REF 06257600 **190,-**

The KaVo Multiflex® coupling 465 RN and the Bien Air Unifix-Traplite quick coupling 104.23.05. can be fitted on to the base adaptor REF 02685000. Regarding other brands, we recommend you to consult the manufacturer.

Service Oil F1

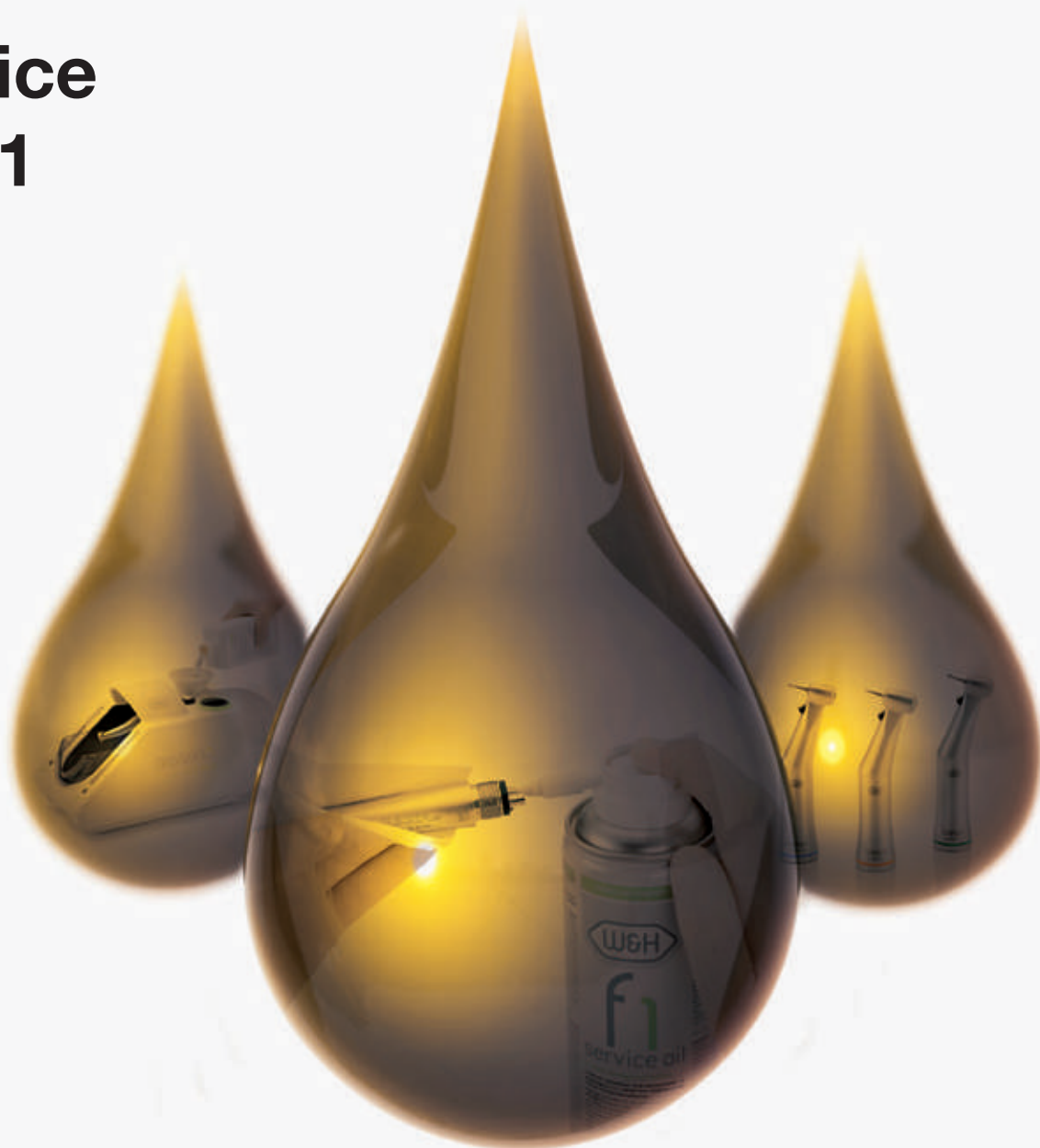

f1 service
oil

W&H Service Oil F1 is a synthetic oil of maximum purity, which has been specially developed for maintenance of W&H turbine handpieces, straight and contra-angle handpieces, surgical instruments, air scalers and air motors.



oil spray can, package of 6 cans

MD-400 (400 ml, 6 pcs)

REF 10940021

203,-

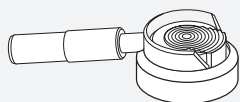

for contra-angle and straight handpieces

REF 02038200

6,60

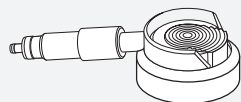

for W&H turbine handpieces, air motors and air scalers with Roto Quick connection

REF 02229200

6,60

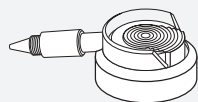

for turbine handpieces and air motors with fixed connection

REF 02036100

6,60

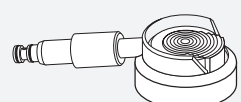

for products with Multiflex connection

REF 04396100

10,50

Spray caps with nozzles

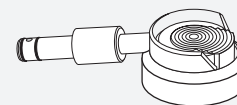

for Alegra turbine handpieces with Sirona connection

REF 05908000

10,50

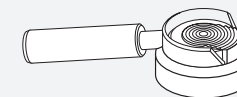

for Alegra turbine handpieces with NSK Mach connection

REF 05773300

10,50

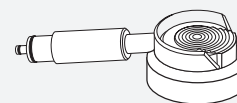

for Alegra turbine handpieces with Bien Air Unifix connection

REF 05772000

10,50

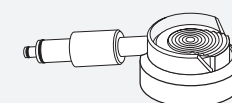

for Alegra turbine handpieces with NSK QD-J connection

REF 05907800

10,50

Keep spray caps with nozzles for oil spray cans in stock. They can be re-used with every new can.

Sterilization, Hygiene & Maintenance

Sterilization, Hygiene & Maintenance

lisa

W&H steam sterilizer



Lisa, consists of:

- › Reversible rack
- › 5 aluminium trays
- › Drain tube
- › Tray holder
- › 8 GB USB drive
- › Door opening tool
- › Factory test

Lisa 17

REF 19931180

8.644,-

Lisa 22

REF 19932180

9.270,-



W&H Lisa type-B steam sterilizer, for the safe sterilization of solid, hollow and porous load in accordance with the EN 13060.

lara^{XL}

W&H steam sterilizer



Lara XL consists of:

- > Chamber rack
- > 6 aluminium trays
- > Drain tube
- > Tray holder
- > 8 GB USB drive
- > Door opening tool
- > Factory test

Lara XL 28

REF 19933110

8.610,-

Activation Code

"Elitrace"

REF 19730015

599,-

Activation Code

"Fast cycle"

REF 19730016

227,-



W&H Lara XL type-B steam sterilizer, for the safe sterilization of solid, hollow and porous load in accordance with the EN 13060.

lara

W&H steam sterilizer



Lara, consists of:

- › Reversible rack
- › 3 aluminium trays
- › Drain tube
- › Tray holder
- › 8 GB USB drive
- › Door opening tool
- › Factory test



Lara 17

REF 19941120

6.925,-

Activation Code

"Performance"

REF 19730001

227,-

Activation Code

"Traceability"

REF 19730003

227,-

Lara 22

REF 19942120

7.543,-

Activation Code

"Fast Cycle"

REF 19730002

227,-

Activation Code

"All in One"

REF 19730004

680,-

W&H Lara type-B steam sterilizer, for the safe sterilization of solid, hollow and porous load in accordance with the EN 13060.

lina

W&H steam sterilizer



Lina, consists of:

- › Reversible rack
- › 3 aluminium trays
- › Drain tube
- › Tray holder
- › 8 GB USB drive
- › Door opening tool
- › Factory test

Activation code "S naked"

REF 19730005 227,-

Activation code "Remote data storage"

REF 19730008 227,-

Activation code "Traceability"

REF 19730011 227,-

Activation code "All in one"

REF 19730013 623,-

Lina 17 50HZ

REF 19951130 6.109,-

Lina 17 60HZ

REF 19951230 6.109,-

Lina 22 50HZ

REF 19952130 6.686,-

Lina 22 60HZ

REF 19952230 6.686,-

Lina 22 50/60 HZ 110V

REF 19952330 6.686,-

Lina 22 50/60 HZ AWF 110V

REF 19952331 6.936,-



with automatic water filling and USB option:

Lina 17 50HZ AWF

REF 19951131 6.358,-

Lina 17 60HZ AWF

REF 19951231 6.358,-

Lina 22 50HZ AWF

REF 19952131 6.936,-

Lina 22 60HZ AWF

REF 19952231 6.936,-

W&H Lina type-B steam sterilizer, for the safe sterilization of solid, hollow and porous load in accordance with the EN 13060.



W&H steam sterilizer



- Lyla, consists of:**
- > Reversible rack
 - > 3 aluminium trays
 - > Drain hose
 - > Tray holder
 - > 8 GB USB stick
 - > Door opening tool
 - > Factory test

Activation Code

"B cycle"	
REF 19730009	1.361,-
Activation Code	
"Remote data storage"	
REF 19730010	227,-
Activation Code	
"Traceability"	
REF 19730012	227,-
Activation Code	
"All in one"	
REF 19730014	1.700,-

Lyla 17 50 HZ	
REF 19951150	5.259,-
Lyla 17 60 HZ	
REF 19951250	5.259,-
Lyla 22 50 HZ	
REF 19952150	5.656,-
Lyla 22 60 HZ	
REF 19952250	5.656,-
Lyla 22 50/60 HZ 110V	
REF 19952350	5.656,-



with automatic water filling, USB option and conductivimeter

Lyla 17 50 HZ AWF	
REF 19951154	5.448,-
Lyla 22 50 HZ AWF	
REF 19952154	5.844,-

W&H Lyla type-S steam sterilizer, designed, certified and validated in accordance with the EN13060.

lexa

W&H steam sterilizer



Lexa, consists of:

- > Reversible rack
- > 4 aluminium trays
- > Drain tube
- > Tray holder
- > 8 GB USB stick
- > Door opening tool
- > Factory test

Lexa 100-125V

REF 19943401

7.112,-

Lexa 200-240V

REF 19943101

7.112,-

Activation Code "EliTrace"

REF 19730018

599,-



W&H Lexa steam sterilizer, for the safe sterilization of solid, hollow and porous load in accordance with ST55.



Together with the LisaSafe label printer, the connection kit is needed

New LisaSafe label printer
REF 19721109 **699,-**



USB connection cable + 1 roll of 2.100 labels + 1 wax/resin ribbon + activation code instructions

LisaSafe connection kit
REF 19721123 **60,90**



LisaSafe consumables kit
2 rolls of 2.100 labels and 2 wax/resin ribbons
REF A810500X **89,-**



Barcode scanner
REF 19721132 **201,-**



Seal²
pouch sealing device, with double roll-holder, produces 12mm seals
REF 19722101 **748,-**
110 Volt Version
REF 19722102 **748,-**



SealVal²
REF 19722103 **1.411,-**

EliReel
Sterilization reels (price per roll)

5.5cm x 200m (MOQ 8 units or multiple) REF 19500000 15,50	
7.5cm x 200m (MOQ 8 units or multiple) REF 19500001 23,-	
10cm x 200m (MOQ 4 units or multiple) REF 19500002 31,-	20cm x 200m (MOQ 2 units or multiple) REF 19500004 63,-
15cm x 200m (MOQ 4 units or multiple) REF 19500003 46,50	25cm x 200m (MOQ 2 units or multiple) REF 19500005 79,-
	30cm x 200m (MOQ 2 units or multiple) REF 19500006 94,-



Seal Check
REF T802100X **44,10**



Thermal printer with cable

Sprint
REF 19721108 **458,-**

Adaptor for Sprint
REF A801503X **59,-**



Roll of thermal paper for Sprint
REF A810504X **3,51**



Standard paper roll, 57 mm for Print
REF A700140X **1,58**

Accessories

Accessories

W&H traceability options

W&H traceability options

Sterilization, Hygiene & Maintenance



Cartridge for Print
REF A700103X **11,-**



Remote Wi-Fi kit (USB dongle)
REF 19721136 **154,-**
Remote Wi-Fi kit (USB dongle) for North American market
REF 19721137 **154,-**



Ethernet cable (LAN) 3 m
REF A801500X **10,50**



Water quality sensor kit for Lina and Lyla
REF X051513X **40,80**



USB kit for Lina and Lyla brings one rear USB port
REF X051405X **18,40**



AWF kit to allow automatic filling for Lina and Lyla sterilizers
REF X051500X **117,-**



AWF kit for Lexa
REF X051302X **131,-**



AWD kit for Lexa
REF X051331X **45,80**

W&H traceability options



Multidem C27
Water supply for W&H or other brand sterilizers
REF 19723112 **395,-**



Multidem C27 resin cartridge
REF A812016X **217,-**
Multidem XL resin cartridge
REF 19721445 **361,-**



New Osmo
large amount of water to supply multiple sterilizers simultaneously
REF 19721134 **1.320,-**



Filter cartridge maintenance kit for new Osmo
Resin and carbon filters
REF A813030X **129,-**



Complete maintenance kit for new Osmo
Osmotic membrane, resin and carbon filters
REF A813053X **588,-**



Multidem XL
large water supply to a number of thermal washer disinfector
REF 19721441 **1.533,-**



Cartridge kit intermediate for Osmo
REF A813019X **87,-**



Cartridge kit complete for Osmo
REF A813010X **617,-**

Water treatments Accessories

Sterilization, Hygiene & Maintenance

Sterilization, Hygiene & Maintenance

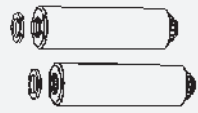

Resin cartridge for Dem 10 and 32
2 sets of 2 pcs or 2 refills

REF A812100X

214,-

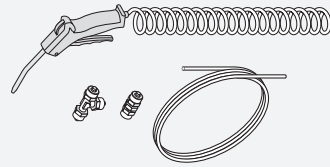

Water dispenser kit

REF A812018X

91,50



Water distiller

for distillation of tap water,
capacity 4 litres

REF 19723101

352,-



Prim

water quality tester for
measuring the conductivity
and purity of the water

REF A800502X

121,-



**Water residue cleaner
for Water distiller 500 g**

REF H802010X

16,20



Water receiver for Water distiller

REF A811017X

19,40



**Activated charcoal
sachet for Water distiller**
12 pcs

REF H802011X

17,60



**Drain tube
with quick coupling**

REF S230900X

8,-

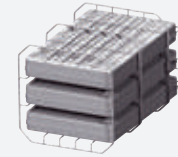

reversible rack for 5 standard
trays or 3 standard cassettes

For 17 liter sterilizers

REF F523031X

74,50

For 22 liter sterilizers

REF F523032X

74,50

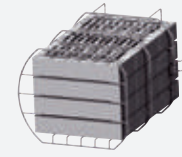

reversible rack for 4 cassettes

For 17 liter sterilizers

REF F523012X

75,50

For 22 liter sterilizers

REF F523015X

83,-

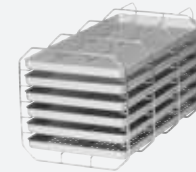

reversible rack for
6 standard trays or
3 cassettes

For 17 liter sterilizers

REF F523033X

74,50

For 22 liter sterilizers

REF F523034X

74,50

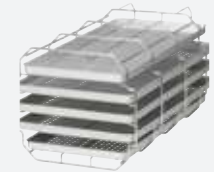

reversible rack for
3 large trays and
2 standard trays or 3 cassettes

For 22 liter sterilizers

REF F523035X

86,-

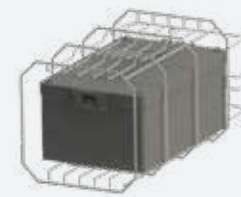

reversible rack for 6 trays or 1 big container

For 22 liter sterilizers

REF F523041X

83,-

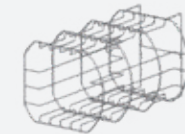

reversible rack for 3 wide cassettes

For 17 liter sterilizers

REF F523020X

75,50

For 22 liter sterilizers

REF F523021X

81,-

reversible rack for 2 cassettes

For 17 liter sterilizers
REF F523016X **75,50**

For 22 liter sterilizers
REF F523017X **81,-**

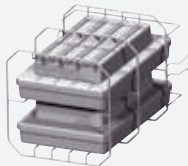

Rack for 4 large trays and 2 standard trays or mixed containers up to 130 mm of height for Lara XL
REF F523038X **115,-**



Rack for 4 large trays and 1 standard tray or mixed containers up to 170 mm of height for Lara XL
REF F523042X **116,-**



Rack for 4 large trays or 4 cassettes for Lara XL and Lexa
REF F523030X **98,50**



Rack for 3 large trays or 4 cassettes for Lara XL and Lexa
REF F523036X **98,50**



Standard tray for 17 liter sterilizers
REF F523204X **25,-**

Standard tray for 22 liters sterilizers
REF F523205X **35,-**



Large tray
For all sterilizers only with rack
REF numbers F523030X, F523035X, F523036X, F523038X, F523042X
REF F523211X **36,60**

Racks & trays Accessories



Tray holder
REF F523001X **16,40**



Bowie & Dick test kit
1 test, minimum order quantity 20 units or multiple
REF T800002X **9,50**



Helix test kit
1 test and 250 test strips
REF T800205X **193,-**

Other consumables and accessories



Door seal for Lisa MB
REF F460503X **35,20**

for Lara XL and Lexa
F460535X **38,90**



Door seal for Lara XL and Lexa
REF F460504X **39,90**

Sterilization, Hygiene & Maintenance

Sterilization, Hygiene & Maintenance

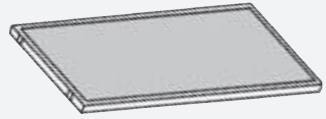

Dust filter for Lina Pro and Lisa until 2015

REF F364502X

12,60

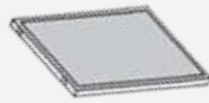

Dust filter for Lisa 2019, Lara, Lina 2020 and Lyla

REF F364511X

12,60



Bacteriological filter

REF W322400X

24,20

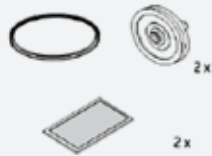

Consumable kit 400-800 cycles for Lina Pro and Lisa until 2015

REF X050326X

110,-

for Lisa 2019, Lara, Lina 2020 and Lyla

REF X050328X

112,-



Lara XL kit 400-800 cycles

REF X050335X

76,-



Perfecta 300 / 600 / 900



A wide variety of materials, top-level requirements, constantly changing prerequisites – the daily bread of dental technicians. With Perfecta 300 / 600, you have a powerful laboratory device at your fingertips which can be used for a variety of purposes and which can bring your ideas and those of your customers effortlessly to life.



complete with control unit (230 V or 115 V), mains cable, motor handpiece, handpiece holder and operating controls (optional for foot control) for table and knee control units

table control unit		foot control unit	
LA-323 T (230 V)		LA-323 F (230 V)	
REF 14933000	1.692,-	REF 14933200	1.460,-
LA-315 T (115 V)		LA-315 F (115 V)	
REF 14933001	1.692,-	REF 14933201	1.460,-
knee control unit			
LA-323 K (230 V)			
REF 14933100	1.692,-		
LA-315 K (115 V)			
REF 14933101	1.692,-		

Perfecta 300



complete with control unit (230 V or 115 V), mains cable, motor handpiece, handpiece holder and operating controls (optional for foot control) for table and knee control units

table control unit		foot control unit	
LA-623 T (230 V)		LA-623 F (230 V)	
REF 14936000	2.209,-	REF 14936200	1.977,-
LA-615 T (115 V)		LA-615 F (115 V)	
REF 14936001	2.209,-	REF 14936201	1.977,-
knee control unit			
LA-623 K (230 V)			
REF 14936100	2.209,-		
LA-615 K (115 V)			
REF 14936101	2.209,-		

Perfecta 600



**operating controls
LA-3 D for Perfecta 300**
REF 05127000 **248,-**



**operating controls
LA-6 D for Perfecta 600**
REF 05243200 **248,-**



**motor handpiece
without cable LA-66**
REF 05201200 **1.158,-**



**motor „E-type“ without cable
LA-3 E (only for Perfecta 300)**
REF 05138800 **798,-**

**motor cable 1.8 m
for Perfecta 300**
REF 05114900 **142,-**

**motor cable 1.8 m
for Perfecta 600**
REF 05116500 **172,-**

Accessories for Perfecta 300 / 600



complete with control unit (230 V or 115 V), operating controls, mains cable, high-speed handpiece, handpiece holder, hose for air supply, hose for coolant supply (only for types with external coolant supplying)

with internal coolant supplying:

table control unit LA-923 TT (230 V)

REF 14939300

2.533,-

LA-915 TT (115 V)

REF 14939301

2.533,-

knee control unit LA-923 KT (230 V)

REF 14939400

2.533,-

LA-915 KT (115 V)

REF 14939401

2.533,-

with external coolant supplying

table control unit LA-923 T (230 V)

REF 14939000

2.533,-

LA-915 T (115 V)

REF 14939001

2.533,-

knee control unit LA-923 K (230 V)

REF 14939100

2.533,-

LA-915 K (115 V)

REF 14939101

2.533,-

Perfecta 900



operating controls LA-9 D
REF 05243400 **248,-**



milling device adaptor to attach the high-speed handpiece LA-9 to milling devices with 16 or 18 mm diameter LA-9
REF 06319400 **145,-**



motor handpiece without cable LA-66
REF 05201200 **1.158,-**

motor cable 1.8 m for motor handpiece LA-66
REF 05116500 **172,-**



high-speed handpiece without cable LA-9
REF 05015900 **1.299,-**

motor cable 1.8 m for high-speed handpiece LA-9
REF 05117800 **236,-**

Accessories for Perfecta 900



foot-operated starter L-NV
REF 05038100 **161,-**



handpiece holder
REF 03211500 **25,20**



wall bracket for operating controls
REF 05138000 **25,90**



1:1, technical handpiece for easy technical working, maintenance-free, Twist tension chuck system, only for handpiece burs
945
REF 14124500 **615,-**

Accessories for Perfecta 300 / 600 / 900

Accessory for E-type version of Perfecta 300

Dental laboratory

Dental laboratory

Osstell



Osstell® helps you to objectively and non-invasively determine implant stability in order to manage patients with risk factors, avoid unnecessarily long treatment times, and achieve more predictable outcomes.



The Osstell Beacon helps you to objectively and noninvasively determine implant stability.

Osstell Beacon
REF 103000

2.770,-



The Osstell IDx Pro combines the best of the Osstell Beacon and the Osstell IDx: a wireless, smart and very intuitive ISQ probe and a comprehensive user interface for implant stability visualization, combined with patient data storage and full connectivity.

Osstell IDx Pro
REF 101000 + 103000

4.436,-



To use Osstell instruments as effectively as possible it is recommended to have more than one probe, it makes it easier to autoclave between patients. The length including cable is 150cm.

Osstell ISQ Probe
REF 100501

457,-



Power supply with an adapter for ac/dc outlet. The use of any other power supply might cause damage to the instrument.

Power Supply IDx
REF 100613

93,-



The SmartPeg™ attaches to the implant and is used together with the measurement instruments Osstell IDx, Osstell Beacon or Osstell ISQ. SmartPegs are single patient use, as reusing them can result in inaccurate readings or damage to the implant.

SmartPeg/Box (5 pcs)
REF 100XXX
(See SmartPeg Reference List)

106,-



The autoclavable SmartPeg Mount is used to carry and connect the SmartPeg to the implant or abutment. SmartPeg mounts comes in boxes of 5.

SmartPeg Mount (5 pcs)
REF 100345

117,-



The Osstell Key works in combination with the Osstell Gateway program, installed on a PC/laptop, to transfer measurements from the Osstell Beacon to the user's account in OsstellConnect.

Osstell Key
REF 100710

65,-



You should use this USB cable for charging the Osstell Beacon.

Beacon USB Cable, C
REF 100709

22,-

The TestPeg can be used to practice measurements and test an Osstell instrument. Note, the device is not for calibrating, only a guide to check the instruments measure function.



Osstell TestPeg
REF 100381

48,-



Contact us

W&H Dentalwerk Bürmoos GmbH

Ignaz-Glaser-Straße 53, Postfach 1

51111 Bürmoos, **Austria**

t + 43 6274 6236-0

f + 43 6274 6236-55

office@wh.com

wh.com

W&H Sterilization Srl.

Via Bolgara, 2

24060 Brusaporto (BG), **Italy**

t + 39 035-66 63 000

f + 39 035-50 96 988

office.sterilization@wh.com

wh.com