

# **INTER DEVENTER**

Member of  
Roto Group

SEALING PROFILES FOR  
WINDOWS AND DOORS

SEALS FOR WINDOWS 

SEALS FOR DOORS 

INDIVIDUAL SOLUTIONS 



---

## **SYSTEM SOLUTIONS**

The Deventer Group has been a leading company in the field of development and production of sealing profiles for windows and doors for over 50 years.

At our four production sites in Germany, the Netherlands, Poland and Russia we translate our systematically developed experience into high-quality structural and technological solutions.

Inter Deventer has been a partner of Polish window and door manufacturers for nearly 25 years. For many years we have been using and improving the ISO 9001 quality management system to guarantee high, repeatable quality of our work at every stage - from designing a seal through its production to customer service.

## **SOLUTIONS FOR DEMANDING APPLICATIONS**

As a reliable partner we design and supply seals that are optimally suited to our customers' needs. We are also ready to share our knowledge and experience by providing expert consultation and technical advice.

Our objectives are primarily defined by high quality demands of our customers.

## **PERFECTION IN DESIGN AND FUNCTIONALITY**

Constantly improved shapes of profiles and selection of the right construction materials result in high functionality of our products. The focus on quality translates into their long life cycle as well.

---

## TABLE OF CONTENTS

<b>SEALS FOR WINDOWS</b> .....	<b>5</b>
Sash rebate seals .....	6
Astragal seals .....	9
Astragal end caps .....	10
Overlap seals .....	11
Other seals .....	13
Seals for wood-aluminium windows .....	14
Seals for wood-aluminium windows - external glazing .....	16
Seals for wood-aluminium windows - internal glazing .....	17
<b>SEALS FOR DOORS</b> .....	<b>19</b>
Seals for internal doors .....	20
Seals for internal rebated doors .....	21
Seals for internal non-rebated doors .....	23
Seals for external doors .....	24
Silicone seals for external doors .....	26
Seals for steel frames .....	28
Seals for threshold termination .....	32
Function seals for doors with convenient swivel point .....	33
<b>OTHER SEALS</b> .....	<b>35</b>
Renovation seals .....	36
Renovation seals with adhesive tape .....	37
Seals for other applications .....	38
Seals for PVC joinery .....	38
<b>TOOLS</b> .....	<b>39</b>

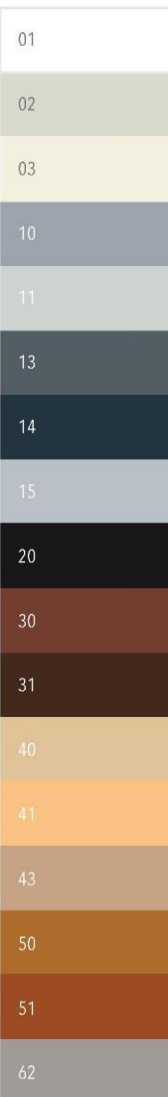



---

## Seals for windows

<b>Sash rebate seals</b>	<b>6</b>
<b>Astragal seals</b>	<b>9</b>
<b>Astragal end caps</b>	<b>10</b>
<b>Overlap seals</b>	<b>11</b>
<b>Additional seals</b>	<b>13</b>
<b>Seals for wood-aluminium windows</b>	<b>14</b>
<b>Seals for wood-aluminium windows - external glazing</b>	<b>16</b>
<b>Seals for wood-aluminium windows - internal glazing</b>	<b>17</b>

**SASH REBATE SEALS**

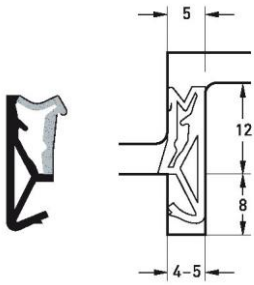

Part number **SP 125**  
 Material **TPS**  
 Pack. unit **200 m spool**

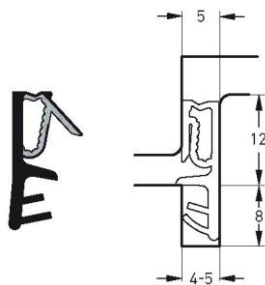

Part number **SP 7612**  
 Material **TPS**  
 Pack. unit **200 m spool**

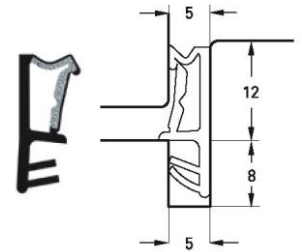

Part number **SP 6850**  
 Material **TPS**  
 Pack. unit **200 m spool**

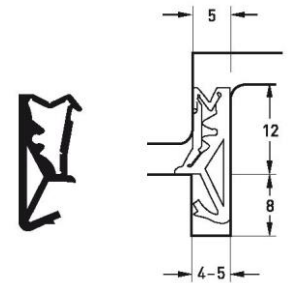
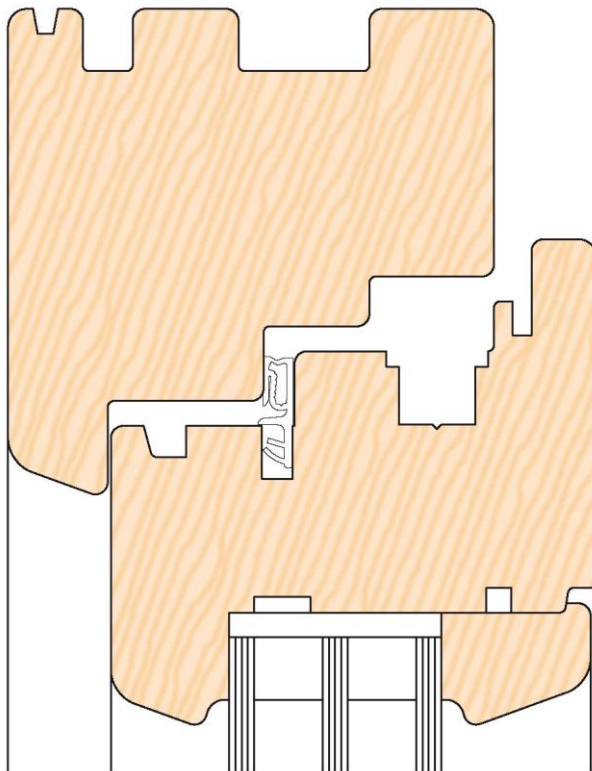

Part number **SV 125**  
 Material **TPE**  
 Pack. unit **200 m spool**

## SASH REBATE SEALS

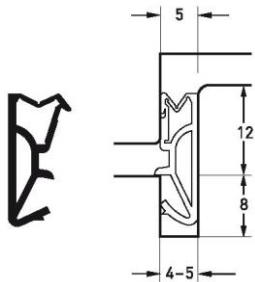

Part number **SV 12**  
 Material **TPE**  
 Pack. unit **200 m spool**

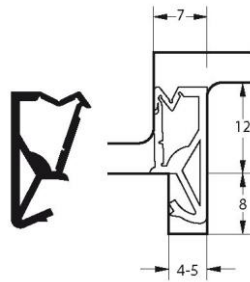

Part number **S 6624**  
 Material **TPE**  
 Pack. unit **150 m spool**

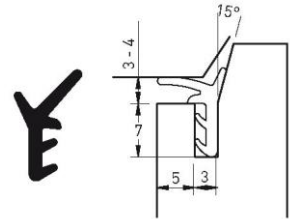

Part number **S 3223a**  
 Material **TPE**  
 Pack. unit **300 m spool**

## SASH REBATE SEALS FOR UNFAVOURABLE SWIVEL POINT

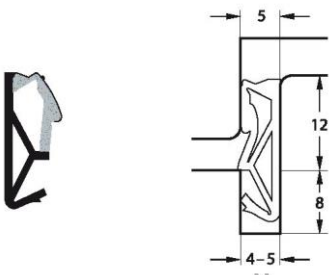

Part number **SP 812**  
 Material **TPS**  
 Pack. unit **200 m spool**

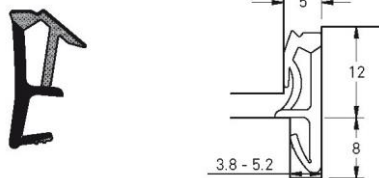

Part number **SPV 12**  
 Material **TPE**  
 Pack. unit **180 m spool**

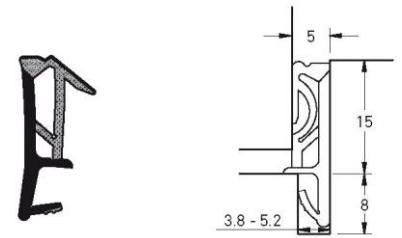

Part number **SPV 15**  
 Material **TPE**  
 Pack. unit **150 m spool**

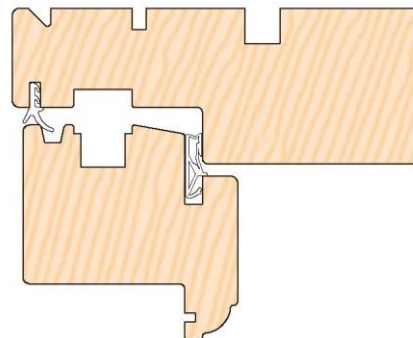
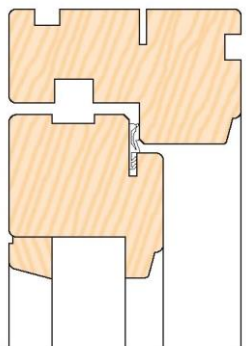

## SASH REBATE SEALS

SEAL FOR TWO REBATES. FOR PARTICULARLY HIGH REQUIREMENTS IN TERMS OF ACOUSTIC INSULATION AND RAIN WATERPROOFING



Part number	<b>S 7503b</b>
Material	TPE
Pack. unit	200 m spool

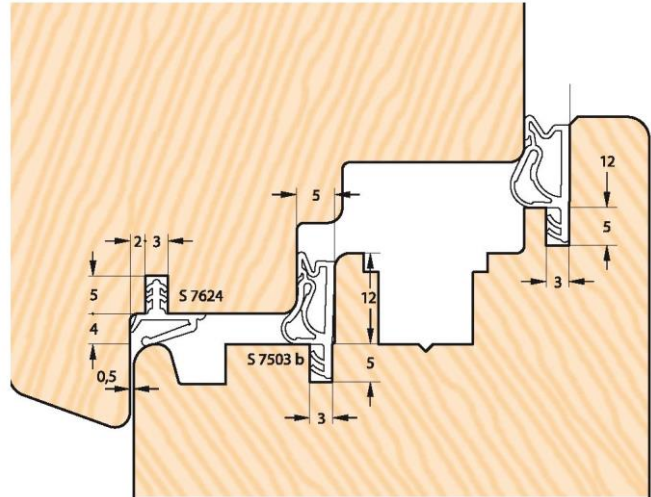

### ADVANTAGES:

- one seal for two rebates
- high dimensional tolerance
- SP 7603 seal suitable for solutions with unfavourable swivel point
- excellent performance during rainwater and air permeability tests
- comfortable closing
- minimum closing force
- possible use of astragal end caps



Part number	<b>S 7624</b>
Material	TPE
Pack. unit	300 m spool



Part number	<b>SP 7603</b>
Material	TPS
Pack. unit	200 m spool



Part number	<b>S 7503a</b>
Material	TPE
Pack. unit	200 m spool

### ADVANTAGES OF USING THE SEAL

#### S 7624

- improved leak proofness under the conditions of driving rain and strong wind
- protection against ingress of water into a rebate, and as a result, significantly reduced strain on lower corners
- suitable for all available window designs



**ASTRAGAL SEALS**

**ONE SEALING PROFILE FOR TWO ASTRAGAL REBATES**

S 7583a

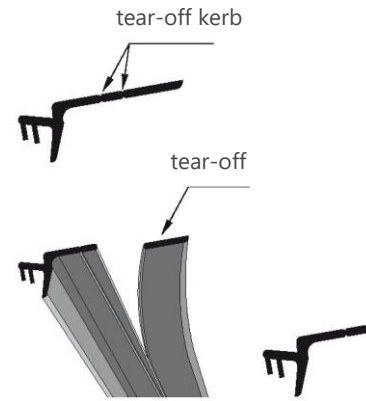
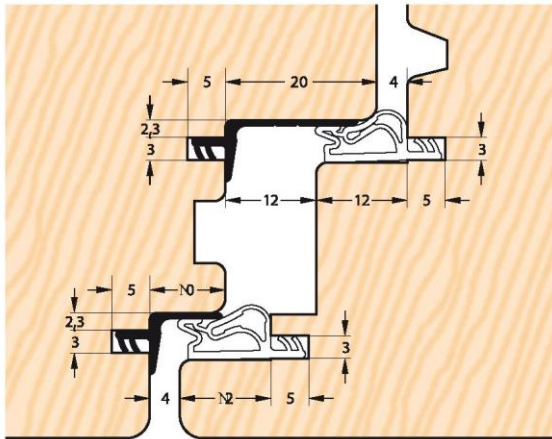

**END CAPS DESIGNED FOR SEALS FOR 12 mm REBATE, 3 mm MOUNTING GROOVE**

- trimming of seal in the mounting part
- installation of end cap in the mounting groove
- seal installation

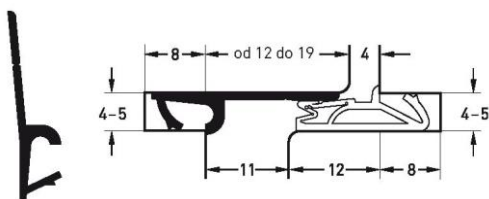
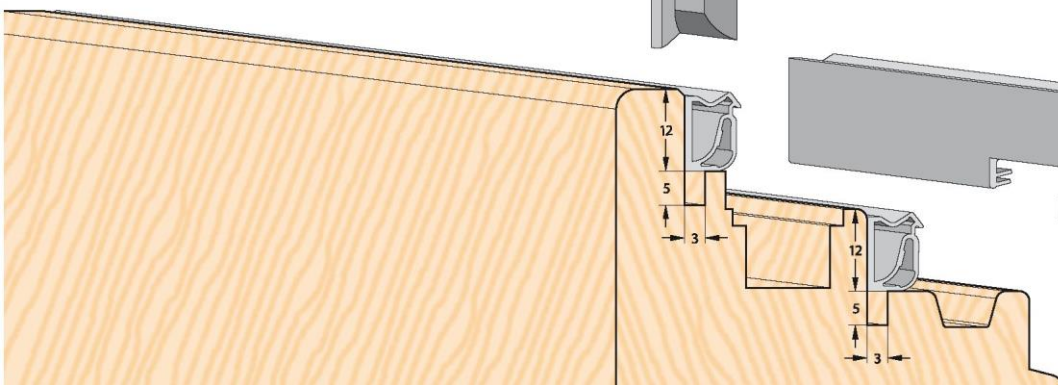
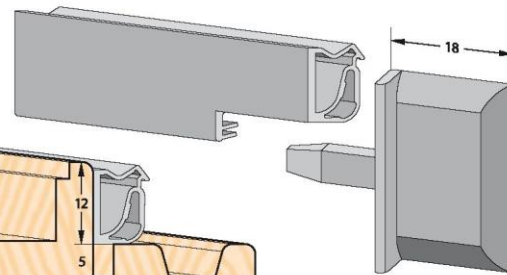
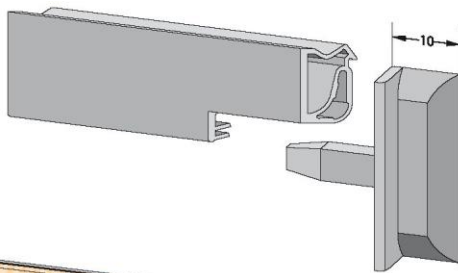

Part number **S 6600e**

Material **TPE**

Pack. unit **200 m sheet**

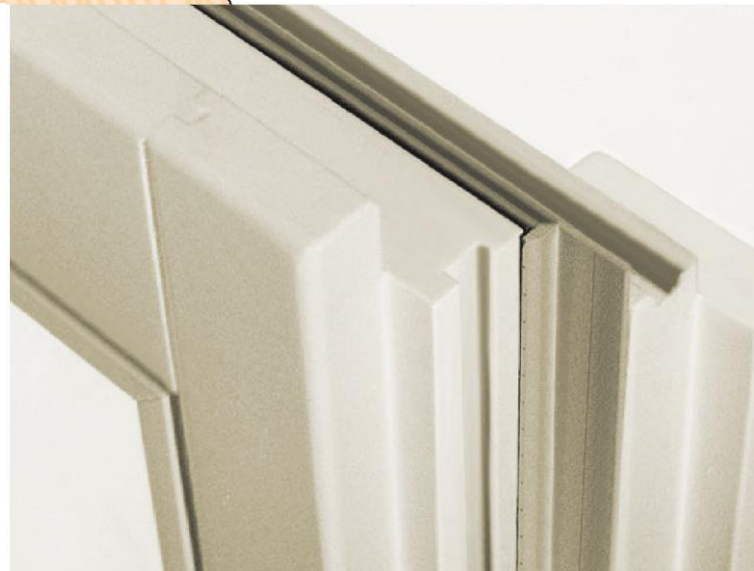

**ASTRAGAL END CAPS**



**VARIO VESU 12, VESU 19 END CAPS**

Designed for astragal sealing. Ensure easy and reliable installation.

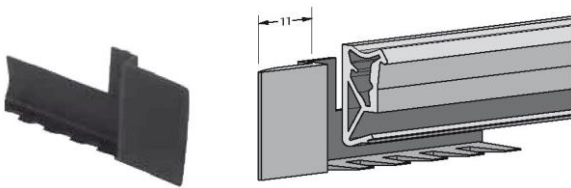

Part number	<b>VESU 12</b>
Material	<b>TPE</b>
Pack. unit	<b>1000 pcs/cardboard box or 100 pairs/pack. unit</b>

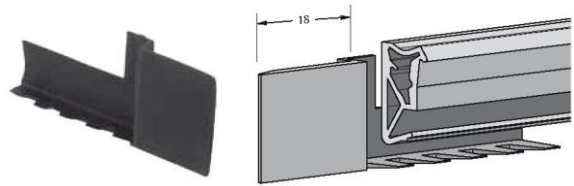

Part number	<b>VESU 19</b>
Material	<b>TPE</b>
Pack. unit	<b>1000 pcs/cardboard box or 100 pairs/pack. unit</b>

**VARIO VES 3 END CAP**

for overlap seals

SV 103b, SP 103a, SP 7610

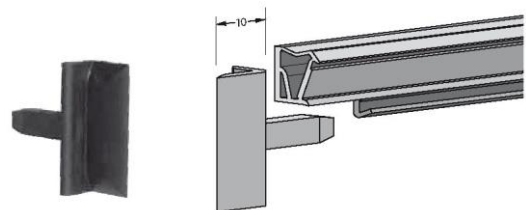

Part number	<b>VES 3</b>
Material	<b>TPE</b>
Pack. unit	<b>1000 pcs/cardboard box or 100 pairs/pack. unit</b>



**OVERLAP SEALS**

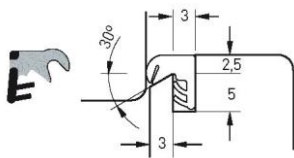
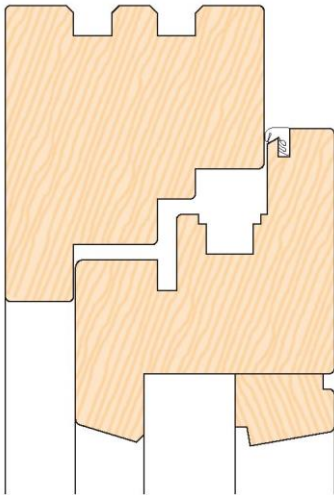

Part number **SP 33b**  
 Material **TPS**  
 Pack. unit **200 m spool**

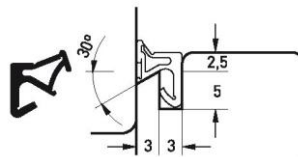

Part number **SV 33**  
 Material **TPE**  
 Pack. unit **200 m spool**

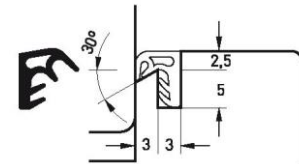

Part number **S 8016**  
 Material **TPE**  
 Pack. unit **200 m spool**

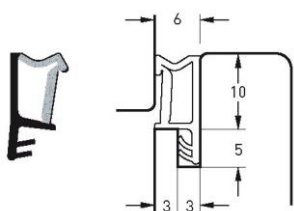
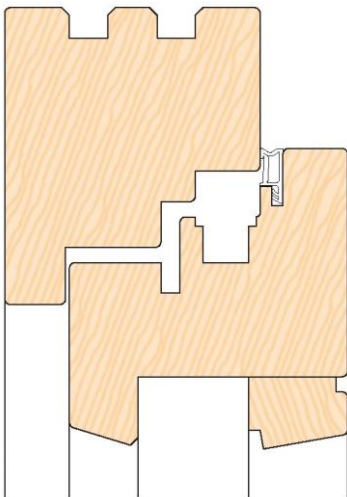

Part number **SP 103a**  
 Material **TPS**  
 Pack. unit **200 m spool**

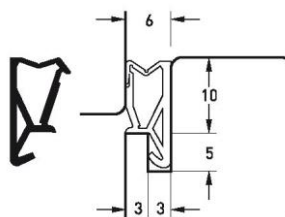

Part number **SV 103b**  
 Material **TPE**  
 Pack. unit **200 m spool**

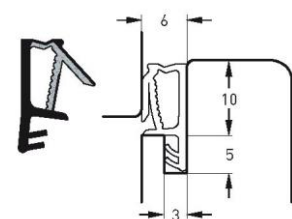

Part number **SP 7610**  
 Material **TPS**  
 Pack. unit **200 m spool**

**OVERLAP SEALS**

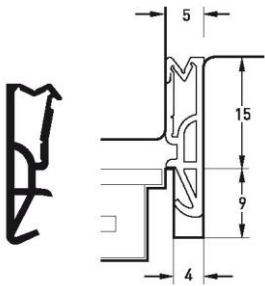
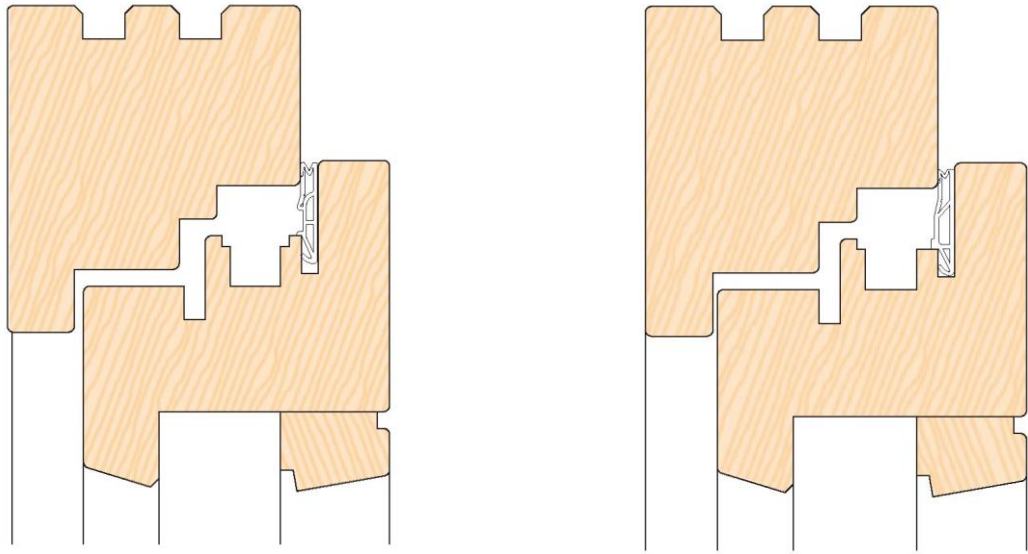

Part number **SV 415a**  
 Material **TPE**  
 Pack. unit **150 m spool**

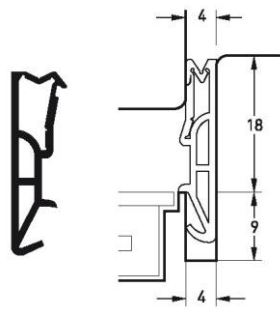

Part number **SV 418**  
 Material **TPE**  
 Pack. unit **150 m spool**

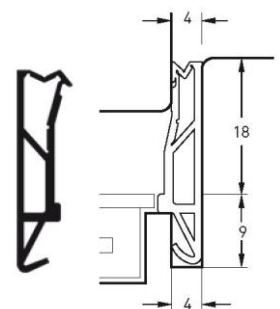

Part number **SV 180**  
 Material **TPE**  
 Pack. unit **150 m spool**

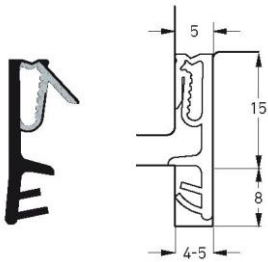

Part number **SP 7715**  
 Material **TPE**  
 Pack. unit **100 m spool**

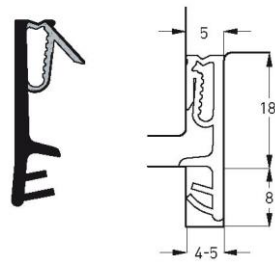

Part number **SP 7718**  
 Material **TPE**  
 Pack. unit **125 m spool**

## OTHER SEALS

### DRY GLAZING SEALS

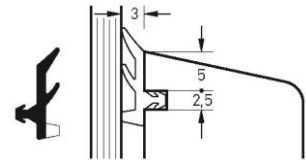
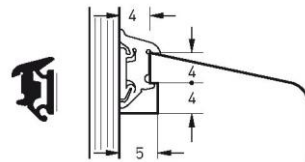
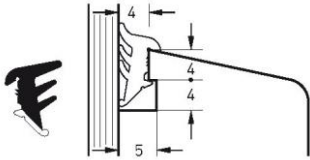
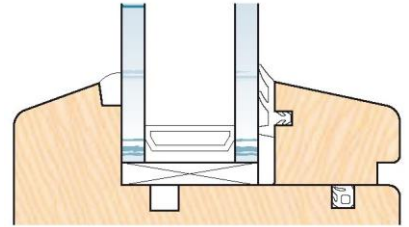
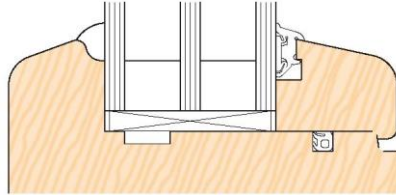
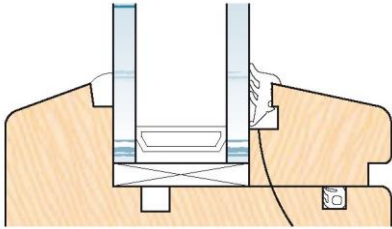

Part number **SV 3**  
 Material **TPE**  
 Pack. unit **300 m spool**

Part number **S 7375k**  
 Material **TPE**  
 Pack. unit **200 m spool**

Part number **S 6584**  
 Material **TPE**  
 Pack. unit **400 m spool**

### SEAL FOR GLAZING BEAD

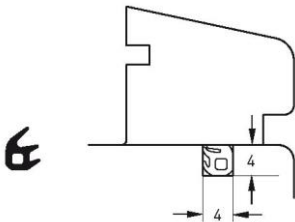

Part number **S 6867**  
 Material **TPE**  
 Pack. unit **400 m spool**

### SEAL FOR MASKING HARDWARE GROOVE

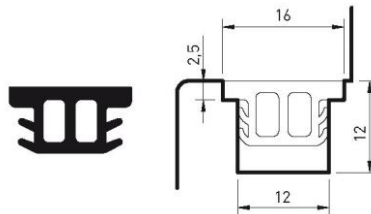

Part number **S 3117f**  
 Material **TPE**  
 Pack. unit **150 m sheet**

### SEAL FOR FRAME TERMINATION

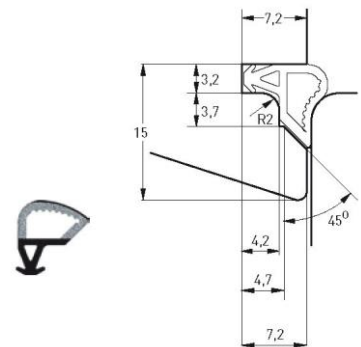

Part number **SP 6803**  
 Material **TPS**  
 Pack. unit **250 m spool**

## SEALS FOR WOOD-ALUMINIUM WINDOWS

### DEVENTER SEALS FOR WOOD-ALUMINIUM WINDOWS

- we offer seals for wood-aluminium windows
- we also provide individual solutions as well as competent and reliable advice
- all our profiles are weldable

System solutions should be used in these profiles. We are ready to design them for you.

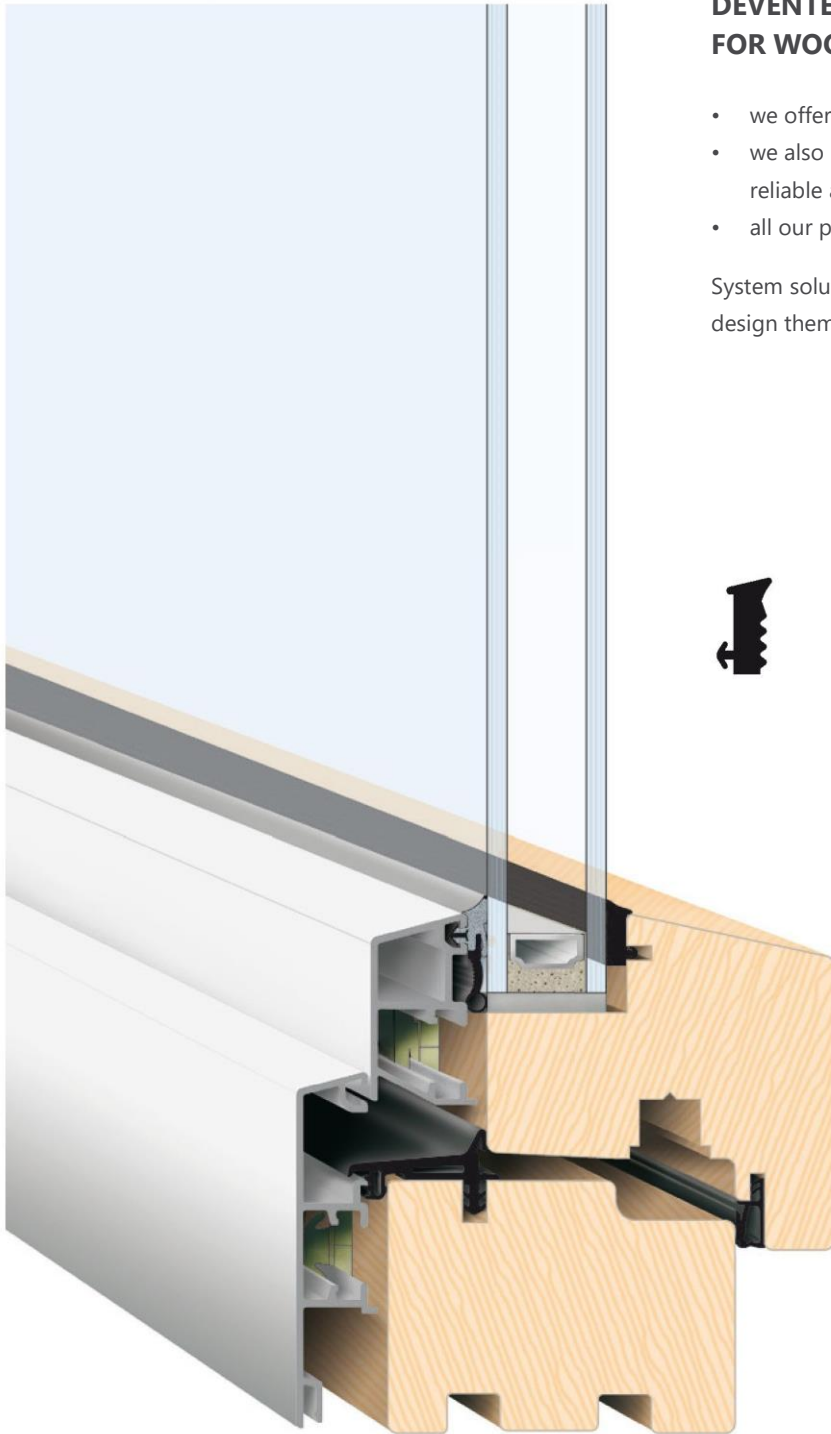



**SEALS FOR WOOD-ALUMINIUM WINDOWS**

**UNIVERSAL SEAL S 7650**

- mounting part of the seal is suitable for many systems
- weldable profile
- seal available in different colours



Part number	<b>S 7650</b>
Material	TPE
Pack. unit	80 m spool

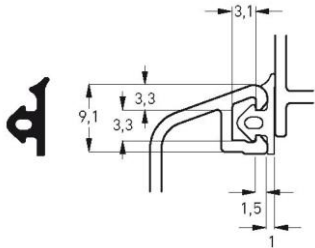
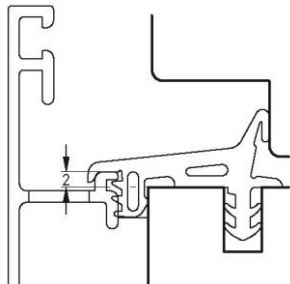
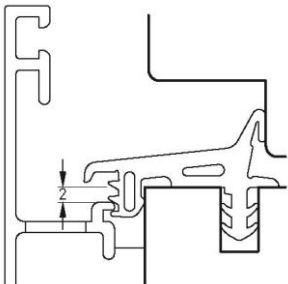
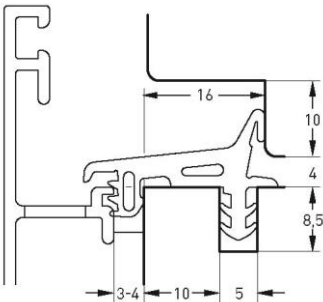

Part number	<b>S 6647</b>
Material	TPE
Pack. unit	500 m spool

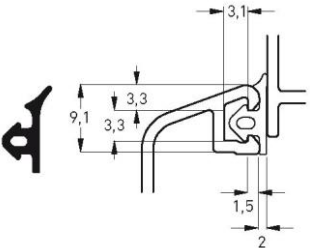

Part number	<b>S 6647 a</b>
Material	TPE
Pack. unit	500 m spool

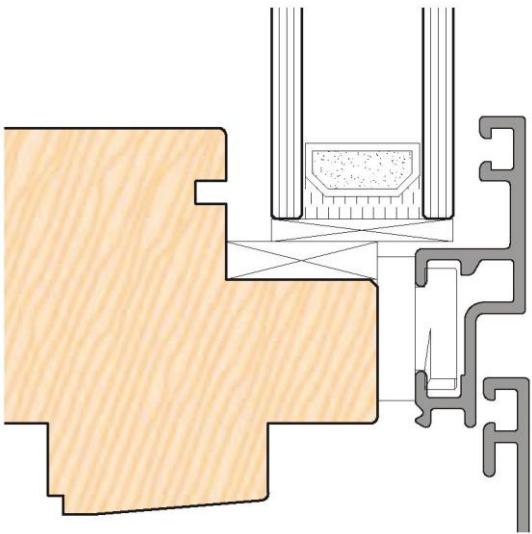

**SEALS FOR WOOD-ALUMINIUM WINDOWS  
EXTERNAL GLAZING**

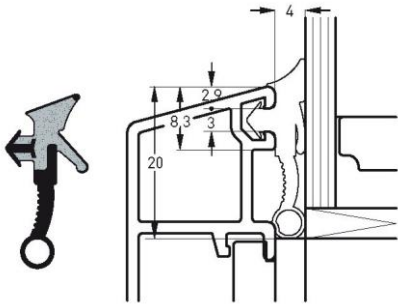
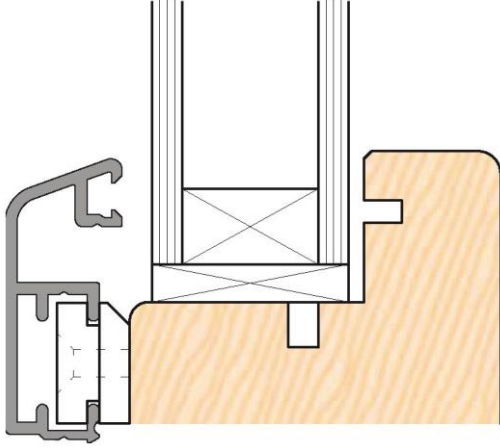

Part number **SP 6881 b**  
Material **TPS**  
Pack. unit **150 m spool**

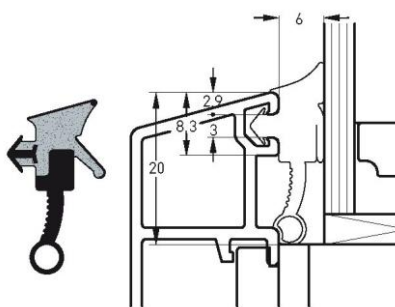

Part number **SP 6882 a**  
Material **TPS**  
Pack. unit **100 m spool**

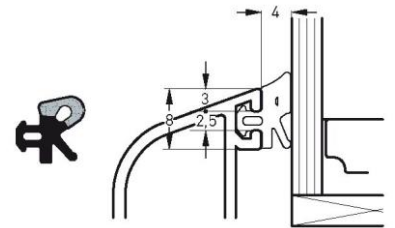

Part number **SP 7618**  
Material **TPS**  
Pack. unit **300 m spool**

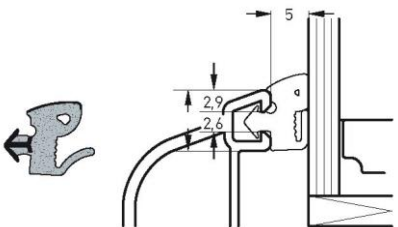

Part number **SP 6942**  
Material **TPS**  
Pack. unit **250 m spool**

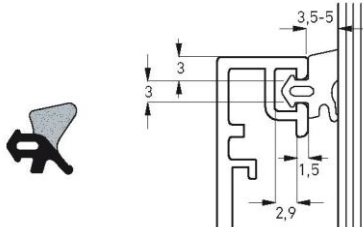

Part number **DS 7354**  
Material **silicone**  
Pack. unit **100 m spool**

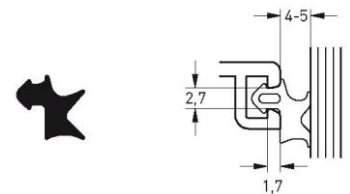

Part number **DS 7620**  
Material **silicone**  
Pack. unit **100 m spool**



**SEALS FOR WOOD-ALUMINIUM WINDOWS  
INTERNAL GLAZING**

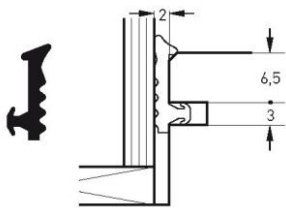
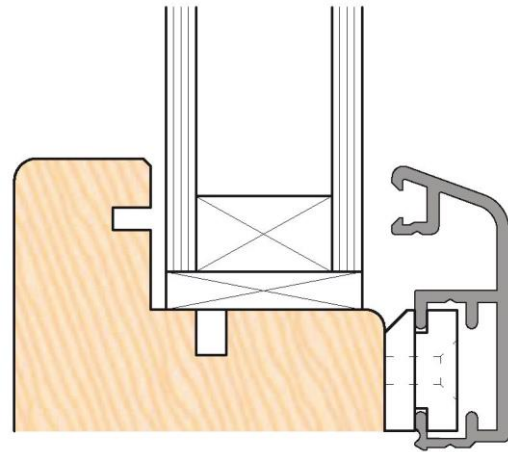

Part number **S 7632**  
Material **TPE**  
Pack. unit **400 m spool**

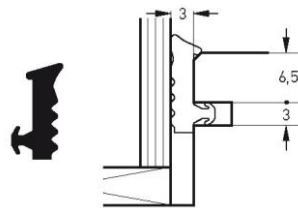

Part number **S 7633**  
Material **TPE**  
Pack. unit **400 m spool**

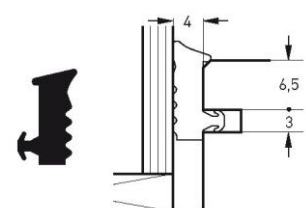

Part number **S 7634**  
Material **TPE**  
Pack. unit **200 m spool**

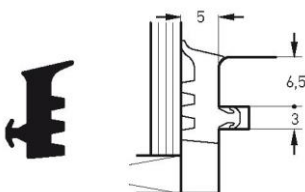

Part number **S 7635**  
Material **TPE**  
Pack. unit **200 m spool**

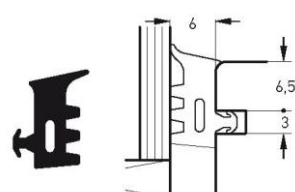

Part number **S 7636**  
Material **TPE**  
Pack. unit **200 m spool**



## Seals for doors

<b>Seals for internal doors</b>	<b>20</b>
<b>Seals for internal rebated doors</b>	<b>21</b>
<b>Seals for internal non-rebated doors</b>	<b>23</b>
<b>Seals for external doors</b>	<b>24</b>
<b>Silicone seals for external doors</b>	<b>26</b>
<b>Seals for steel frames</b>	<b>28</b>
<b>Seals for threshold termination</b>	<b>32</b>
<b>Function seals for doors with convenient swivel point</b>	<b>33</b>

SEALS FOR INTERNAL DOORS

EXAMPLE OF REBATED DOORS

DEVENTER SEALS FOR INTERIOR DOORS

- large sealing range even if the door leaf is warped
- excellent acoustic insulation properties
- features protecting against smoke penetration

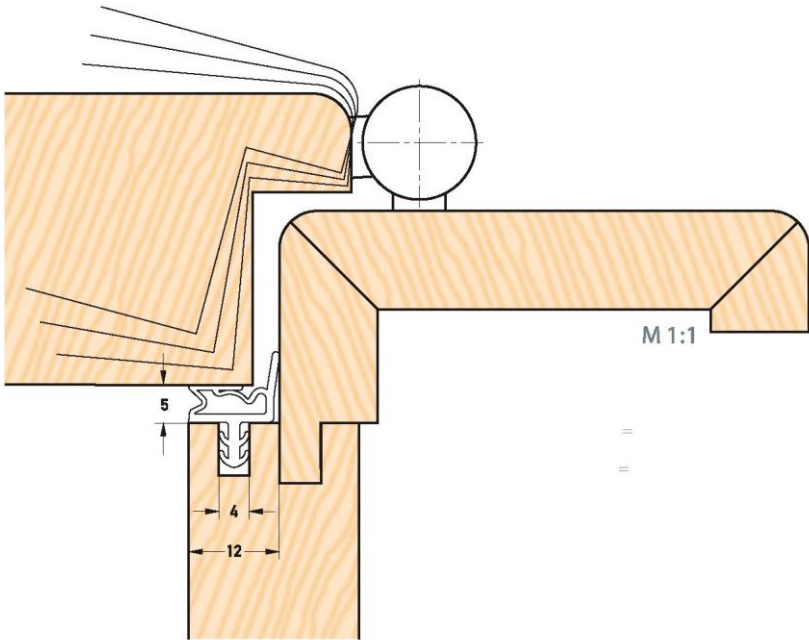

CONVENIENT SWIVEL POINT



Part number	<b>S 6612</b>
Material	TPE
Pack. unit	100 m spool

EXAMPLE OF NON-REBATED DOORS

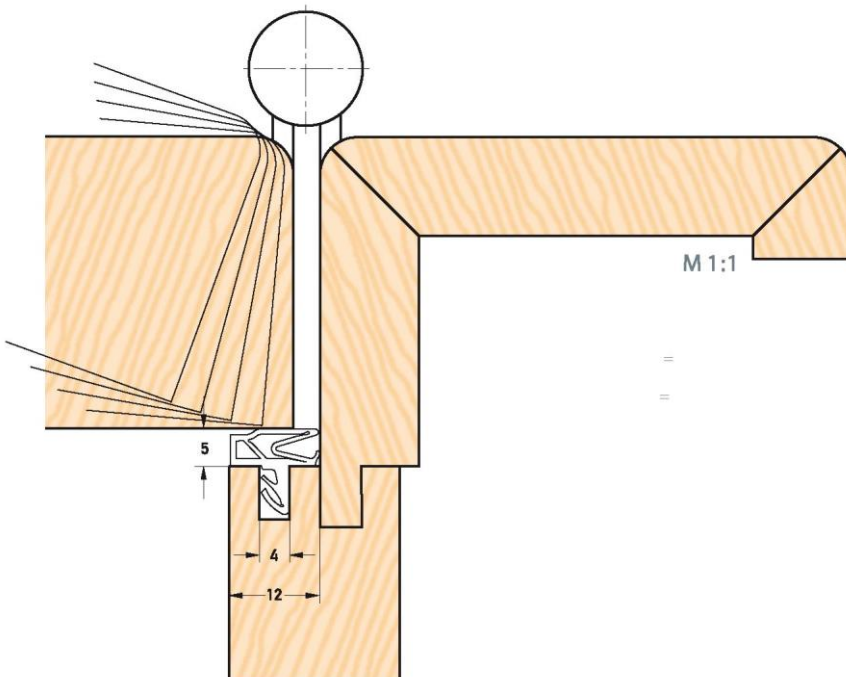

UNFAVOURABLE SWIVEL POINT



Part number	<b>S 6577</b>
Material	TPE
Pack. unit	200 m spool

**SEALS FOR INTERNAL REBATED DOORS**

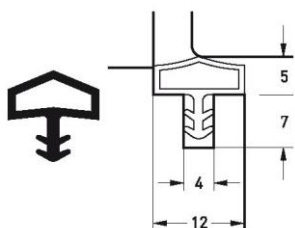
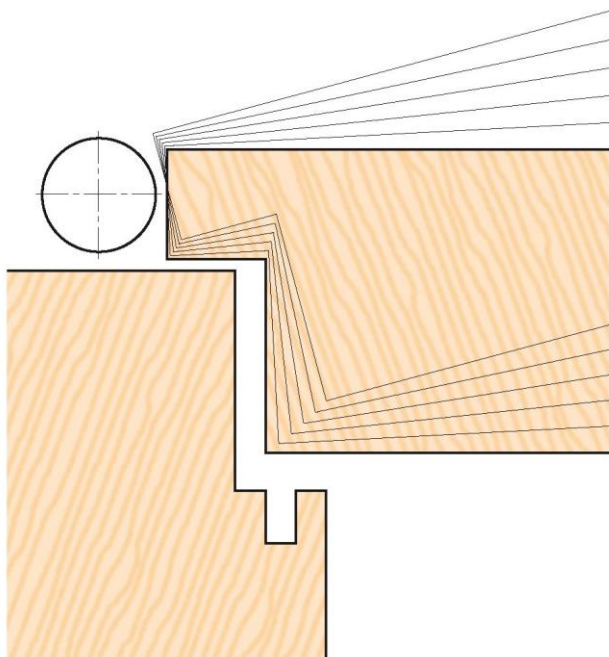

Part number **S 7292**  
**M 7292**  
Material **TPE / PVC**  
Pack. unit **100 m coil**

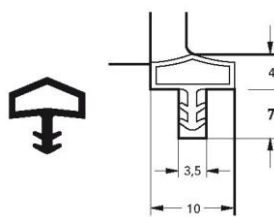

Part number **S 7292/10**  
Material **TPE / PVC**  
Pack. unit **100 m coil**

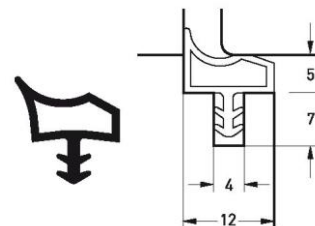

Part number **S 3967**  
**M 3967**  
Material **TPE / PVC**  
Pack. unit **100 m coil**

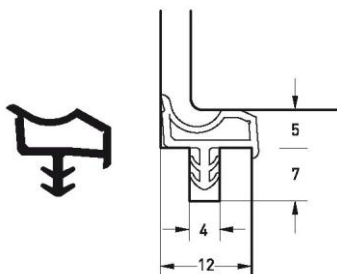

Part number **S 6582**  
**M 6582**  
Material **TPE / PVC**  
Pack. unit **100 m coil**

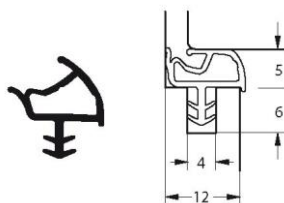

Part number **S 7330a**  
**M 7330**  
Material **TPE / PVC**  
Pack. unit **100 m coil**

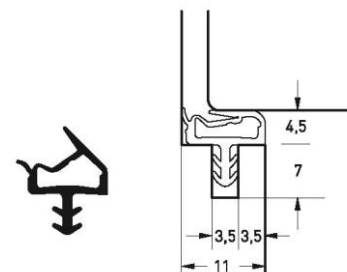

Part number **S 6535**  
**M 6535**  
Material **TPE / PVC**  
Pack. unit **150 m coil**  
**200 m spool**

SEALS FOR INTERNAL REBATED DOORS

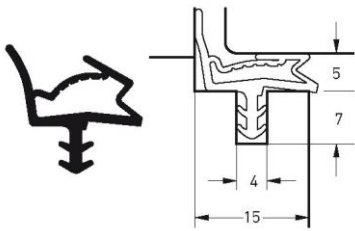
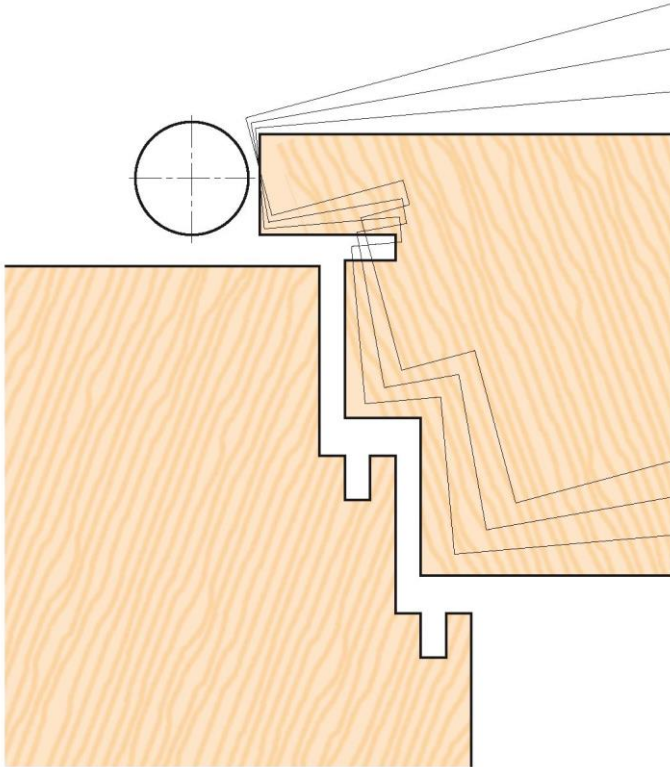

Part number **S 7683**  
 Material **TPE**  
 Pack. unit **60 m coil**

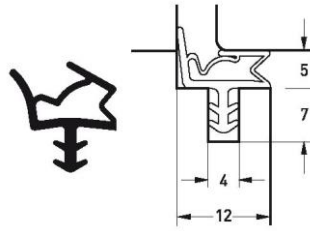

Part number **S 6612**  
 Material **TPE**  
 Pack. unit **100 m coil**

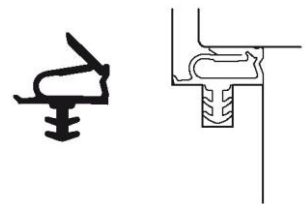

Part number **S 7381**  
 Material **TPE**  
 Pack. unit **180 m spool**  
 Colour **Black**

**SEALS FOR INTERNAL NON-REBATED DOORS**

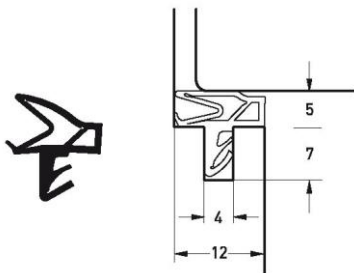
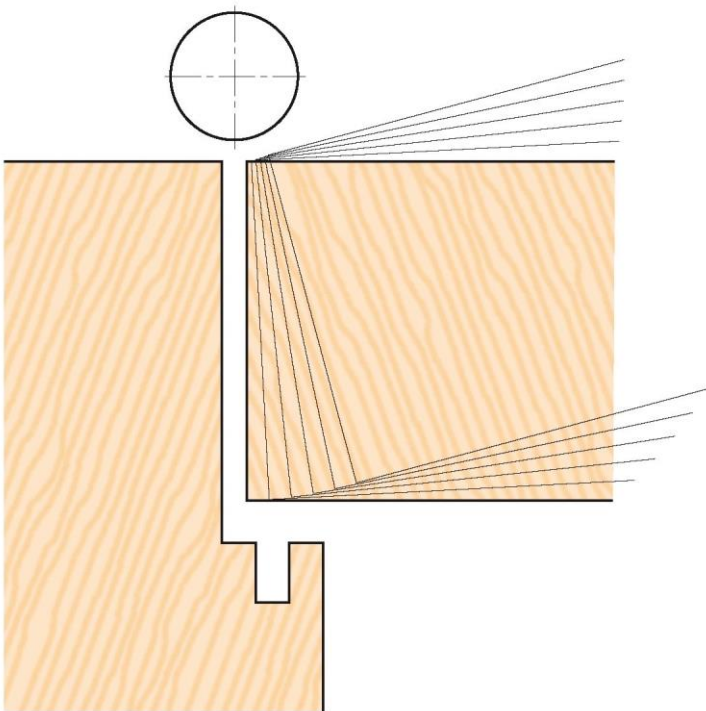

Part number **S 6577**  
 Material **TPE**  
 Pack. unit **200 m spool**

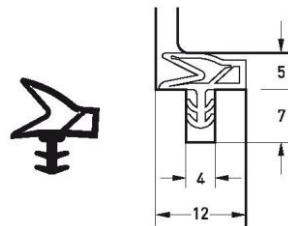

Part number **DS 6577**  
 Material **TPE**  
 Pack. unit **50 m coil**

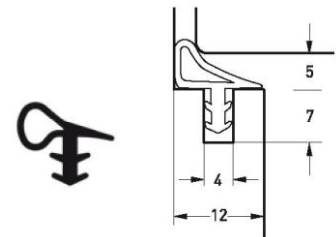

Part number **S 485**  
 Material **TPE**  
 Pack. unit **150 m coil**

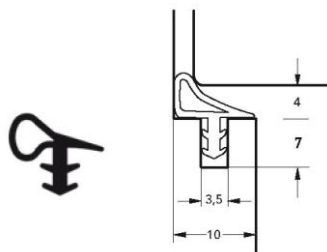

Part number **S 485/10**  
 Material **TPE**  
 Pack. unit **200 m coil**

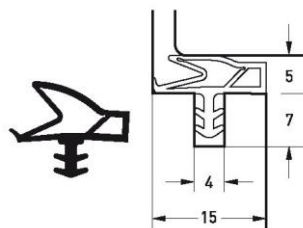

Part number **S 6699**  
 Material **TPE**  
 Pack. unit **150 m spool**

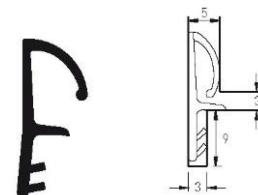

Part number **S 7326**  
 Material **TPE**  
 Pack. unit **160 m coil**

SEALS FOR EXTERNAL DOORS

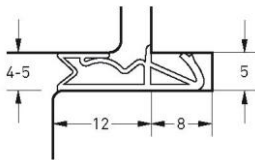
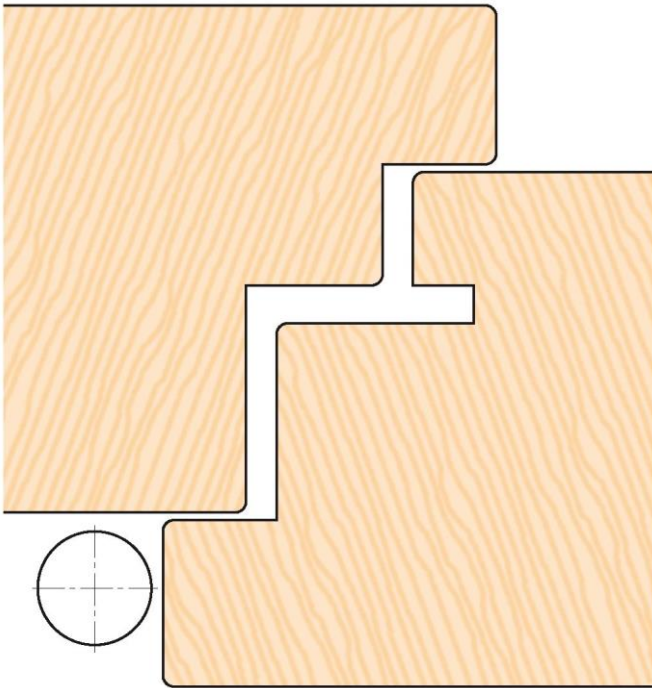

Part number **S6512a**  
Material **TPE**  
Pack. unit **180 m spool**

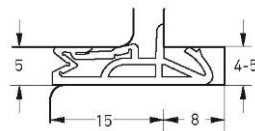

Part number **S7672**  
Material **TPE**  
Pack. unit **150 m spool**

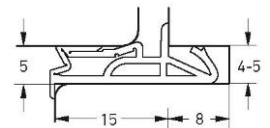

Part number **S7322**  
Material **TPS**  
Pack. unit **150 m spool**

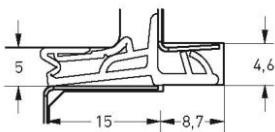

Part number **S7312**  
Material **TPE**  
Pack. unit **150 m spool**

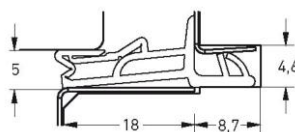

Part number **S7346**  
Material **TPE**  
Pack. unit **100 m coil**

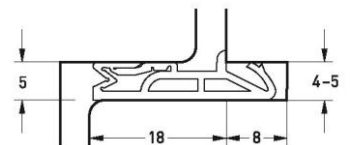

Part number **SV185**  
Material **TPE**  
Pack. unit **150 m spool**



**SEALS FOR EXTERNAL DOORS**

**TPS FOAM SEALS**

- design of the foot ensures easy installation and secure retention
- straight seating in the groove regardless of frame material type
- reliable functionality with very good acoustic insulation properties

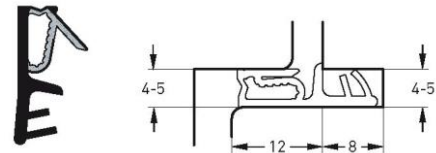

Part number	<b>SP 7612</b>
Material	<b>TPS</b>
Pack. unit	<b>200 m spool</b>

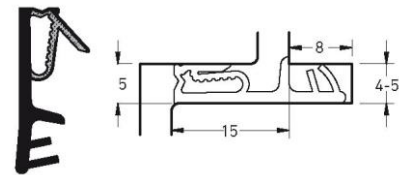

Part number	<b>SP 7715</b>
Material	<b>TPS</b>
Pack. unit	<b>100 m spool</b>

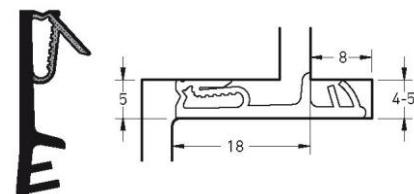

Part number	<b>SP 7718</b>
Material	<b>TPS</b>
Pack. unit	<b>125 m spool</b>

**SILICONE SEALS FOR EXTERNAL DOORS**

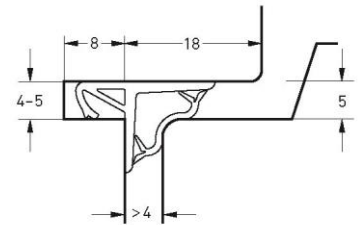
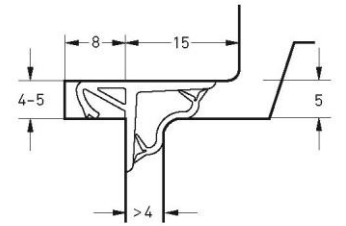
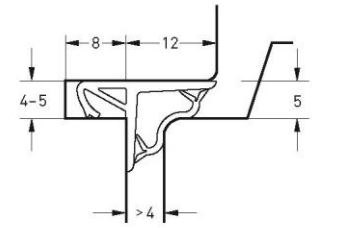
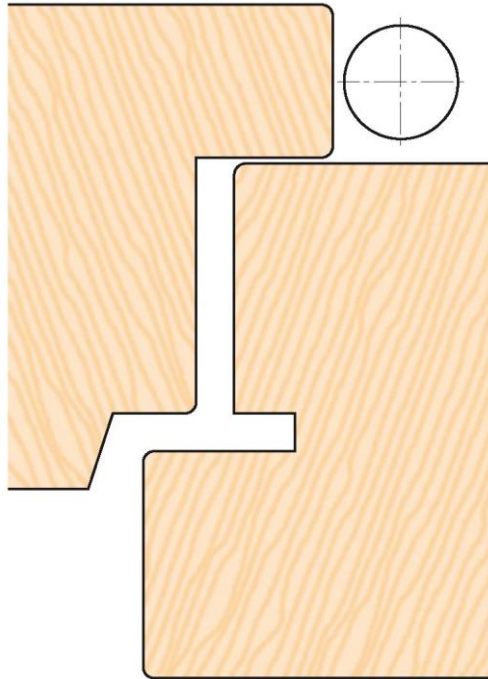

Part number	<b>DS 12-18</b>
Material	<b>Silicone</b>
Pack. unit	<b>50 m coil</b>

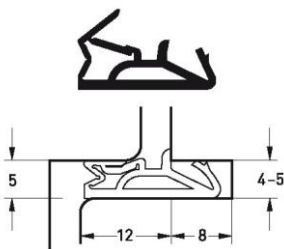

Part number	<b>DS 112 a</b>
Material	<b>Silicone</b>
Pack. unit	<b>50 m coil</b>

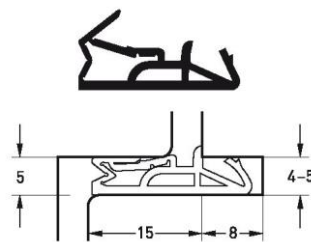

Part number	<b>DS 155 a</b>
Material	<b>Silicone</b>
Pack. unit	<b>50 m coil</b>

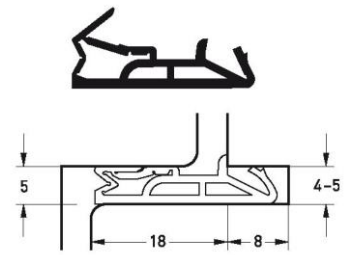

Part number	<b>DS 185 a</b>
Material	<b>Silicone</b>
Pack. unit	<b>50 m coil</b>

## SILICONE SEALS FOR EXTERNAL DOORS

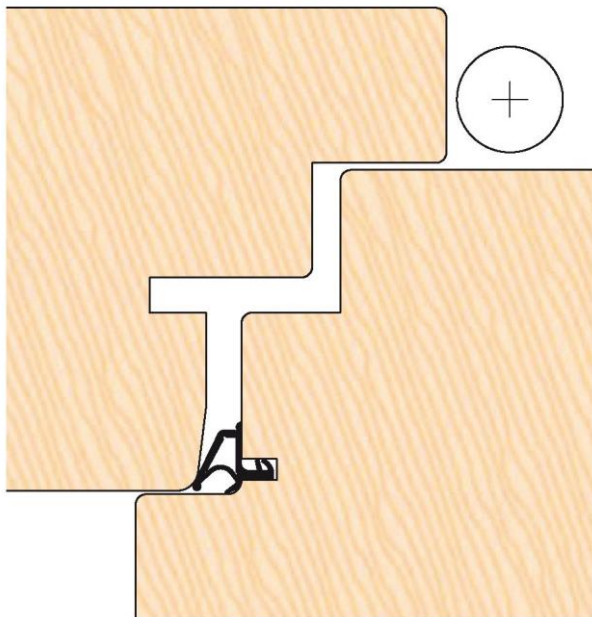

### CONVENIENT SWIVEL POINT

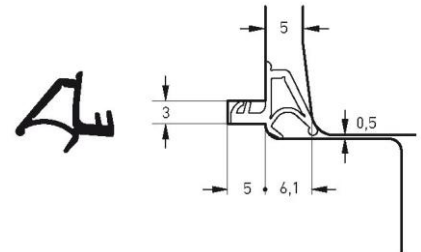

Part number	<b>DS 7621</b>
Material	<b>Silicone</b>
Pack. unit	<b>50 m coil</b>

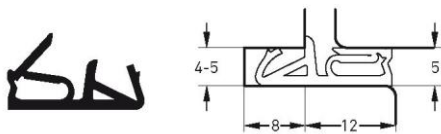

Part number	<b>DS 6922 a</b>
Material	<b>Silicone</b>
Pack. unit	<b>50 m coil</b>

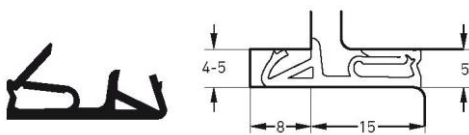

Part number	<b>DS 6955 a</b>
Material	<b>Silicone</b>
Pack. unit	<b>50 m coil</b>

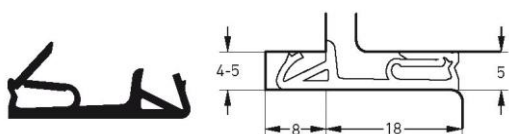

Part number	<b>DS 6988 a</b>
Material	<b>Silicone</b>
Pack. unit	<b>50 m coil</b>

### UNFAVOURABLE SWIVEL POINT

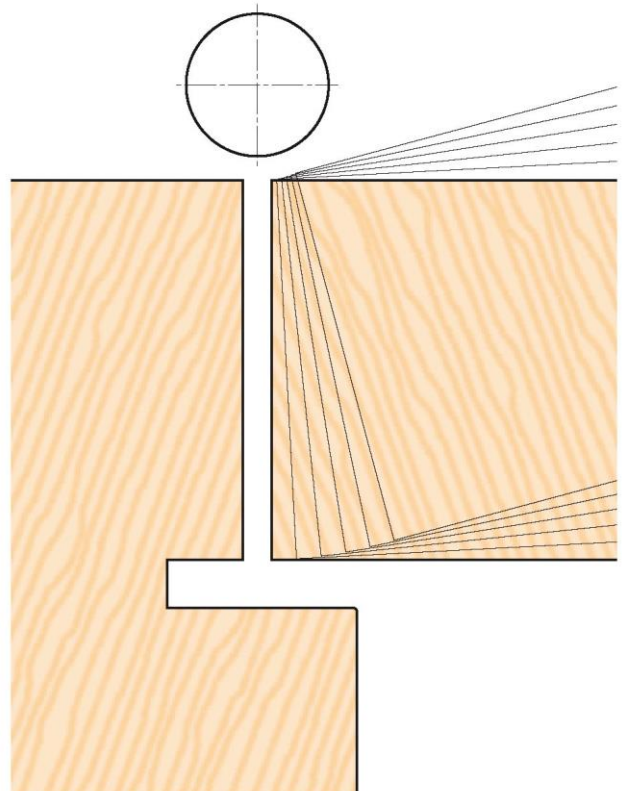

## SEALS FOR STEEL FRAMES

### REBATED DOORS

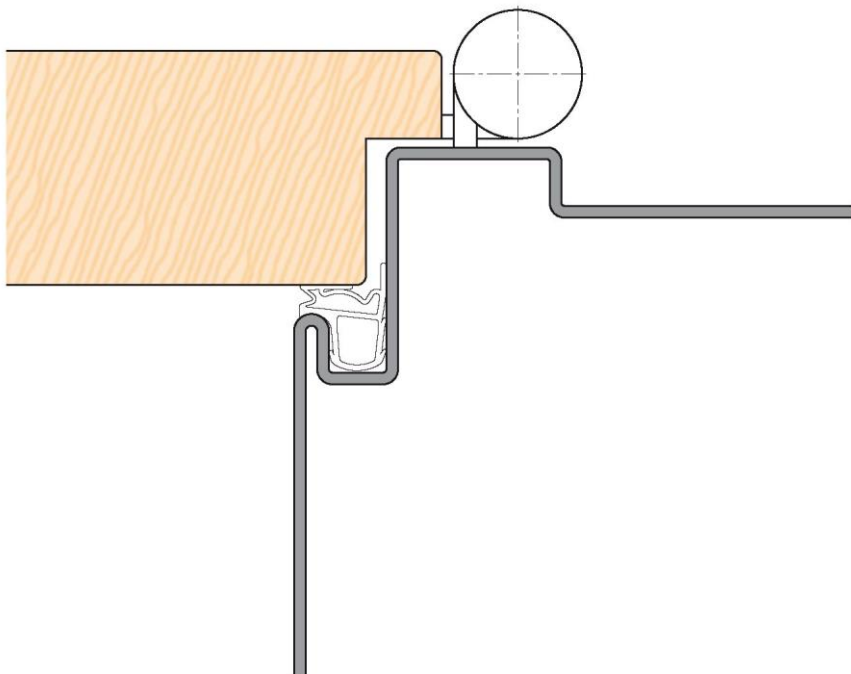

Part number **S 6741**

Material **TPE**

Pack. unit **70 m**

### NON-REBATED DOORS

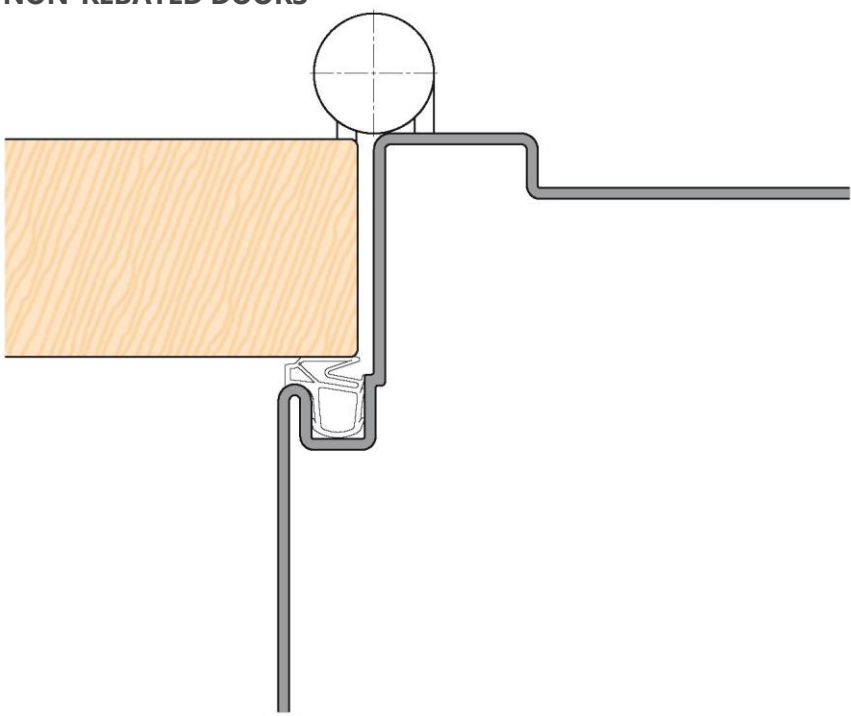

Part number **S 6793**

Material **TPE**

Pack. unit **100 m**

**SEALS FOR STEEL FRAMES**

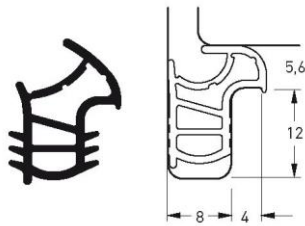

Part number	<b>S 7234</b> <b>M 7234</b>
Material	<b>TPE</b>
Pack. unit	<b>100 m</b>

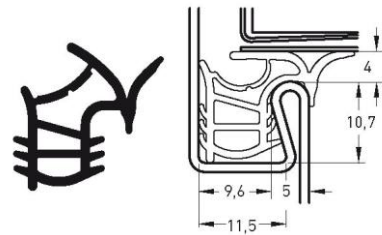

Part number	<b>S 7728</b>
Material	<b>TPE</b>
Pack. unit	<b>100 m</b>

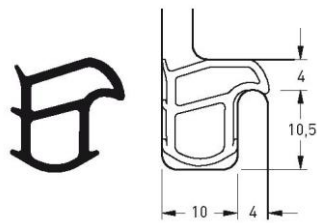

Part number	<b>S 4167e</b> <b>M 4167</b>
Material	<b>TPE</b>
Pack. unit	<b>100 m</b>

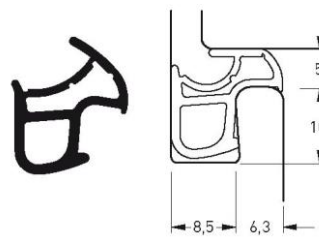

Part number	<b>S 7243</b> <b>M 7243</b>
Material	<b>TPE</b>
Pack. unit	<b>100 m</b>

**SEALS FOR STEEL FRAMES**

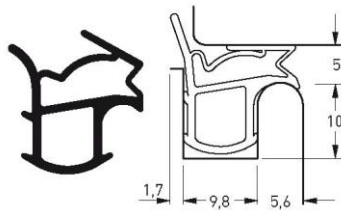

Part number **S 6741**

Material **TPE**

Pack. unit **70 m**

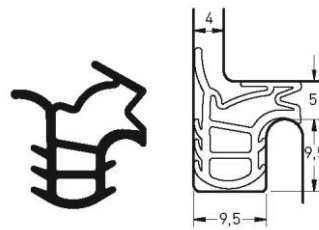

Part number **S 7437a**

Material **TPE**

Pack. unit **80 m**

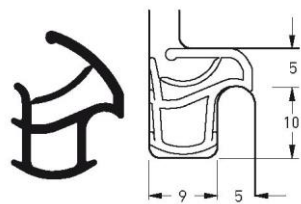

Part number **S 7343**

Material **TPE**

Pack. unit **100 m**

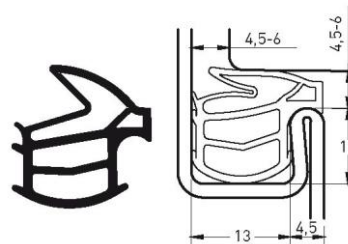

Part number **S 7484**

Material **TPE**

Pack. unit **70 m**

SEALS FOR STEEL FRAMES

SEALS FOR NON-REBATED DOORS

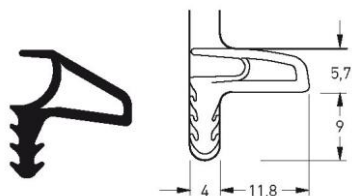

Part number **S 6586**

Material **TPE**

Pack. unit **150 m**

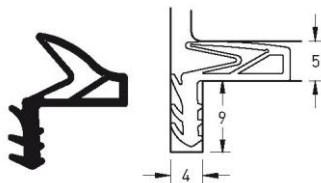

Part number **S 7477**

Material **TPE**

Pack. unit **150 m**

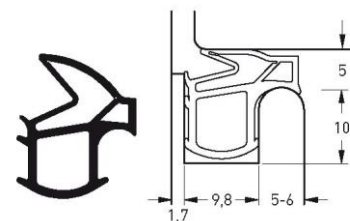

Part number **S 6793**

Material **TPE**

Pack. unit **100 m**

SEALS FOR STEEL DOOR LEAF

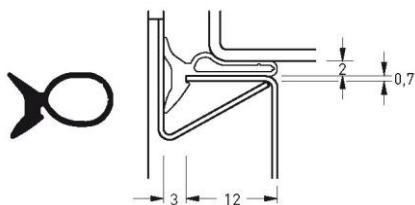

Part number **S 7301**

Material **TPE**

Pack. unit **200 m**

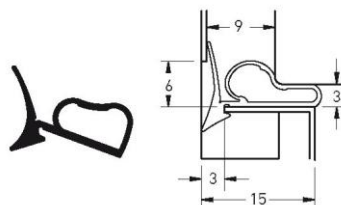

Part number **S 7472a**

Material **TPE**

Pack. unit **200 m**

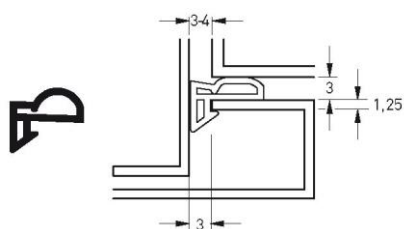

Part number **S 6734**

Material **TPE**

Pack. unit **300 m**

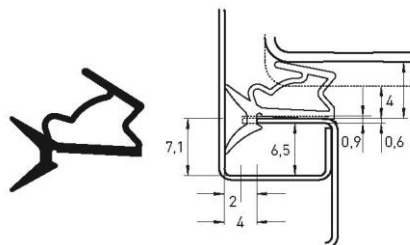

Part number **S 7475**

Material **TPE**

Pack. unit **150 m**

**SEALS FOR THRESHOLD TERMINATION**

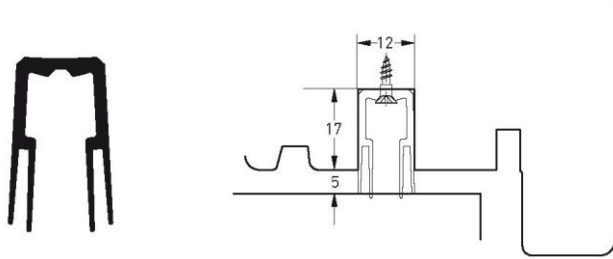

Part number	<b>S 7639</b>
Material	<b>TPE</b>
Pack. unit	<b>10 x 1.1 rm</b>
Colour	<b>RAL 7045</b>

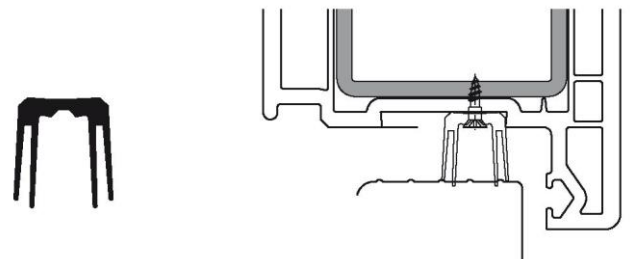

Part number	<b>S 7688</b>
Material	<b>TPE</b>
Pack. unit	<b>10 x 1.1 rm</b>
Colour	<b>RAL 7045</b>

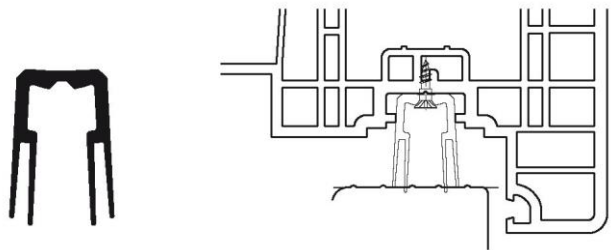

Part number	<b>S 7690</b>
Material	<b>TPE</b>
Pack. unit	<b>10 x 1.1 rm</b>
Colour	<b>RAL 7045</b>

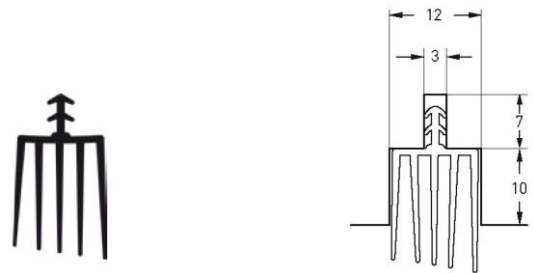

Part number	<b>S 6701</b>
Material	<b>TPE</b>
Pack. unit	<b>2 m</b>

**DOOR THRESHOLD SEALS - ACCESSORIES**

**PHON STOP**

The sealing profile adapts to door frame opening ensuring optimum acoustic insulation and smoke protection.

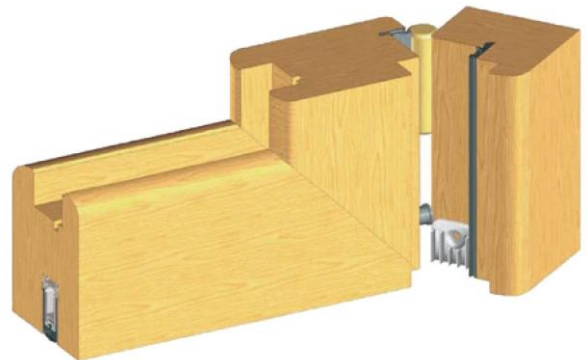

Profile can be easily installed in the frame rebate.  
Flexible elements can be adjusted to the gap width.



## FUNCTION SEALS FOR DOORS WITH CONVENIENT SWIVEL POINT

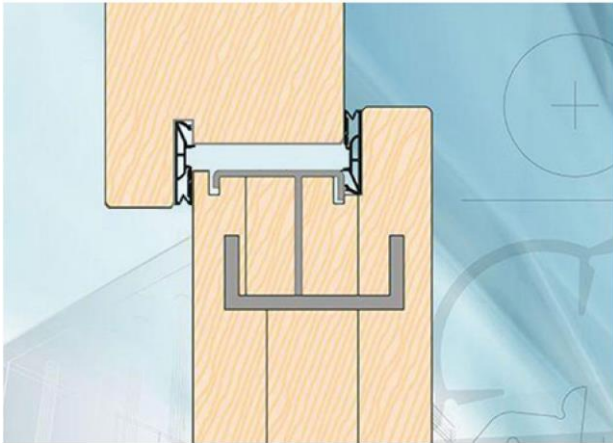

Part number **SP 7715**



Part number **S 7672**



Part number **DS 6955a**



Part number **S 7312**

### ADDITIONAL THRESHOLD SEALING

#### ADVANTAGES

- easy installation
- suitable for external doors and balcony doors with low threshold
- protection against wind and rain
- reliable sealing in combination with the 'Phon Stop' product

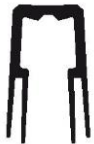
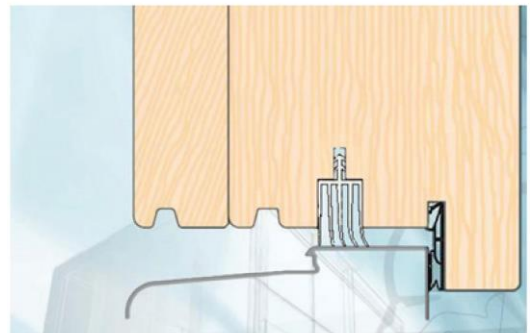
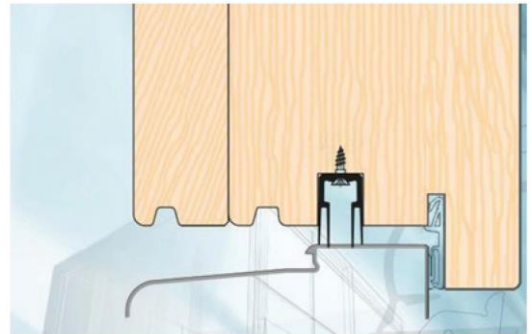

Part number **S 7639**



Part number **S 6701**

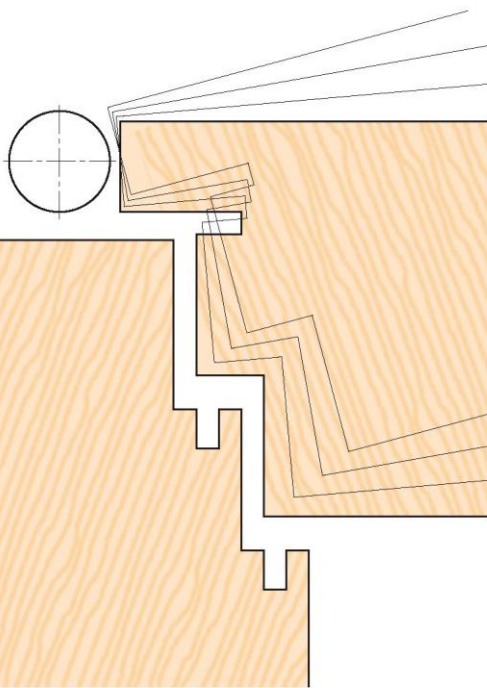

Part number **S 6612**



Part number **S 6512a**



## Other seals

<b>Renovation seals</b>	<b>36</b>
<b>Renovation seals with adhesive tape</b>	<b>37</b>
<b>Seals for other applications</b>	<b>38</b>
<b>Seals for PVC joinery</b>	<b>38</b>

**RENOVATION SEALS**

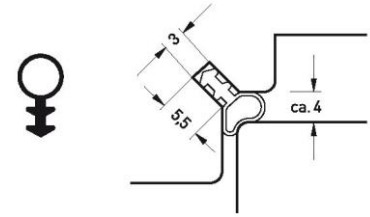
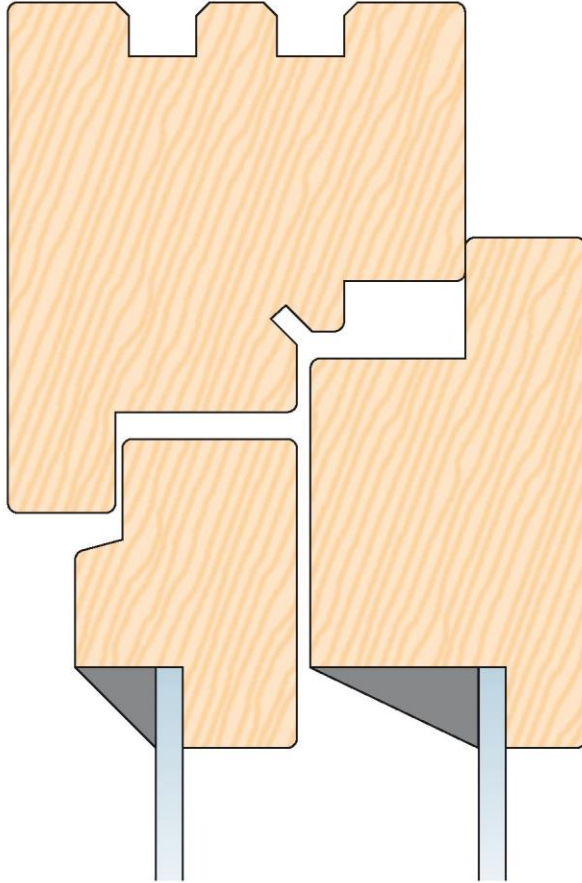

Part number **S 9608**  
 Material **TPE**  
 Pack. unit **100 m spool**

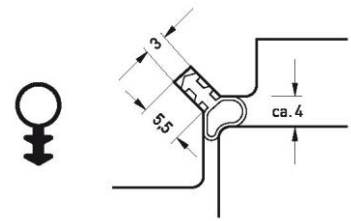

Part number **DS 9608**  
 Material **silicone**  
 Pack. unit **200 m spool**

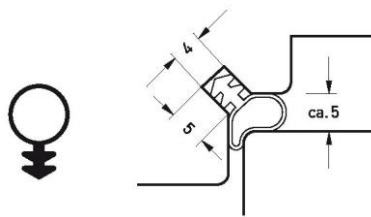

Part number **S 9609**  
 Material **TPE**  
 Pack. unit **100 m spool**

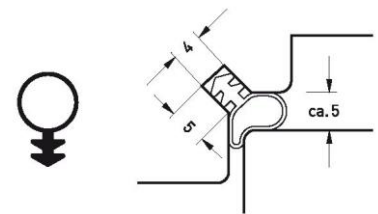

Part number **DS 9609**  
 Material **Silicone**  
 Pack. unit **100 m spool**

**RENOVATION SEALS WITH ADHESIVE TAPE**

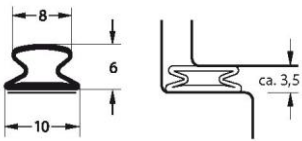
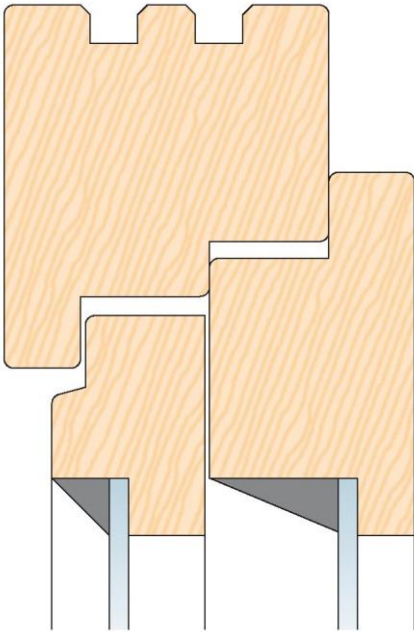

Part number **S 9414K**

Material **TPE**

Pack. unit **200 m spool**

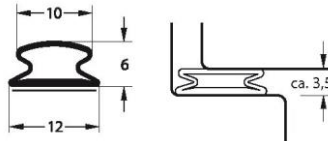

Part number **S 9216K**

Material **TPE**

Pack. unit **100 m spool**

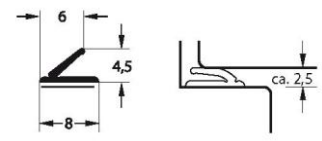

Part number **S 9168aK**

Material **TPE**

Pack. unit **200 m spool**

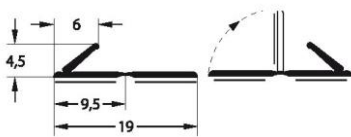

Part number **S 9200-10K**

Material **TPE**

Pack. unit **100 m spool**

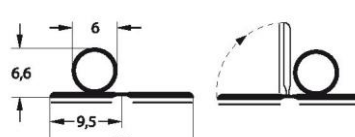

Part number **S 9100-10K**

Material **TPE**

Pack. unit **100 m spool**

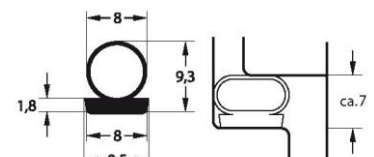

Part number **S 9612 K**

Material **TPE**

Pack. unit **100 m spool**

**SEALS FOR OTHER APPLICATIONS**

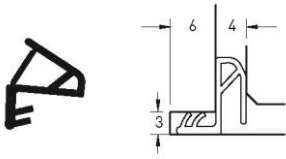

Part number **S 7442**  
 Material **TPE**  
 Pack. unit **250 m spool**

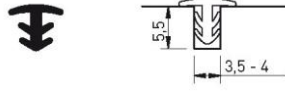

Part number **S 7775**  
 Material **TPE**  
 Pack. unit **100 m spool**

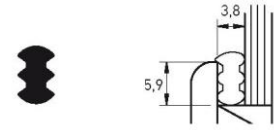

Part number **M 7242**  
 Material **PVC**  
 Pack. unit **400 m spool**

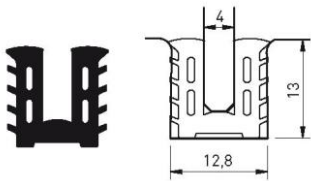

Part number **M 7287**  
 Material **PVC**  
 Pack. unit **100 m spool**

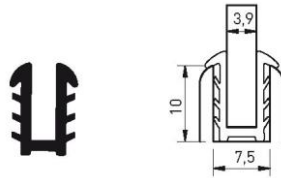

Part number **M 7582**  
 Material **PVC**  
 Pack. unit **250 m spool**

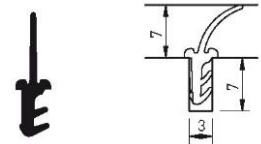

Part number **S 6782**  
 Material **TPE**  
 Pack. unit **300 m spool**

**SEALS FOR PVC JOINERY**

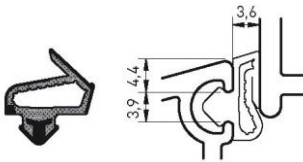

Part number **SP 6919a**  
 Material **TPS**  
 Pack. unit **200 m spool**

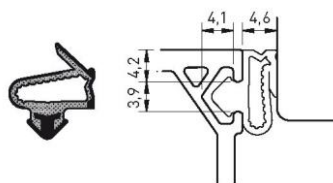

Part number **SP 6920a**  
 Material **TPS**  
 Pack. unit **200 m spool**

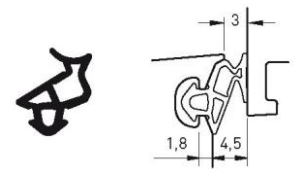

Part number **S 7338**  
 Material **TPS**  
 Pack. unit **200 m spool**

PROFILE ROLLERS



Part number **A 009P**



Part number **A 015P**



Part number **A 016P**



Part number **A 017P**

CLAMPS



Part number **DSV 1521 Lowe**

ROLLERS



Part number **DSV 1526 Lowe**



Part number **DSV 1526 P**

ACCESSORIES



Part number **DSV 1525 P**



Part number **DSV 1527 P**



Part number **DSV 1525 Lowe**



Part number **DSV 1527 Lowe**



# INTER DEVENTER

Member of  
Roto Group

Inter-Deventer Sp. z o. o.  
ul. Generała Stefana Grota-Roweckiego 187

PL 41-200 Sosnowiec

Phone no. (032) 291 90 00 - 1

Fax (032)674 1320

e-mail: [info@deventer.pl](mailto:info@deventer.pl)

[www.deventer.pl](http://www.deventer.pl)

