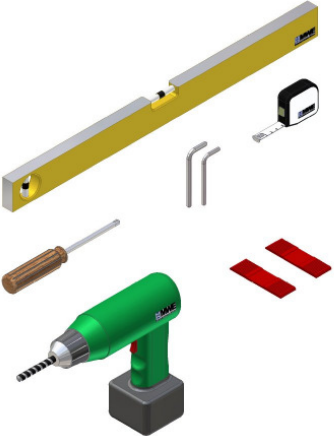
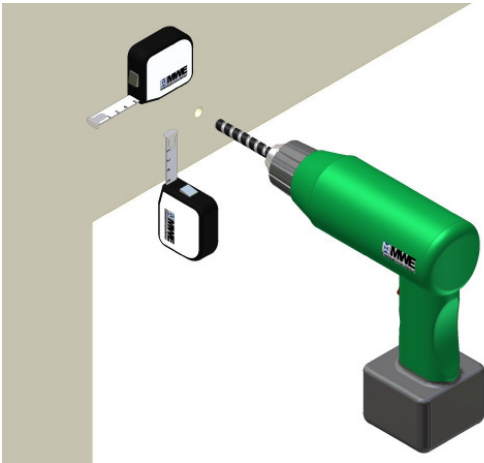
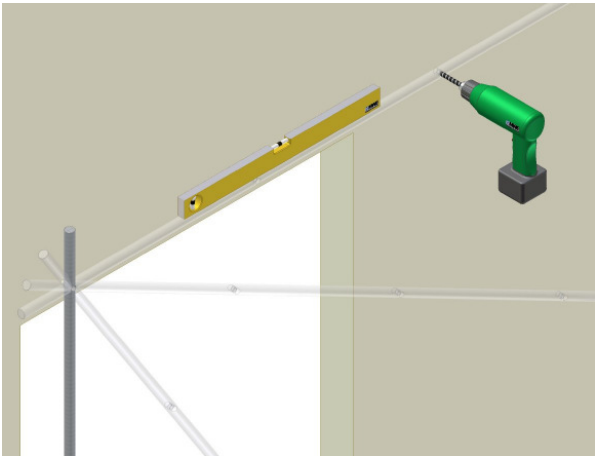

Installation Instruction

System Klassik (ST.1000.KL)

Am Steinbusch 7
D-48351 Everswinkel
Tel.: +49(0)2582-9960- 0
Fax: +49(0)2582-9960-28
Internet: www.mwe.de

	<h2>Tools</h2> <ul style="list-style-type: none">- water level- measuring tape- power drill- drill (diameter 1: 8 mm; diameter 2: 10 mm)- crosstip screwdriver- allen key set- jaw wrench (size: 10 mm)- glass shims <p>Please read power drill safety instructions carefully before installation.</p>
	<h2>1</h2> <h3>First Wall Hole</h3> <p>Drill hole for outer runner rail mount into wall according to your planning detail</p>
	<h2>2</h2> <h3>Further Wall Holes</h3> <p>Mount loosely outer wall fasteners for runner rail (see step 3). Adjust runner rail into horizontal position using water level. Use runner rail as your “drilling template” to drill all necessary fastening holes with 8 mm drill. Use 10 mm drill to widen holes for anchors.</p>

Installation Instruction

System Klassik (ST.1000.KL)

Am Steinbusch 7
D-48351 Everswinkel
Tel.: +49(0)2582-9960- 0
Fax: +49(0)2582-9960-28
Internet: www.mwe.de

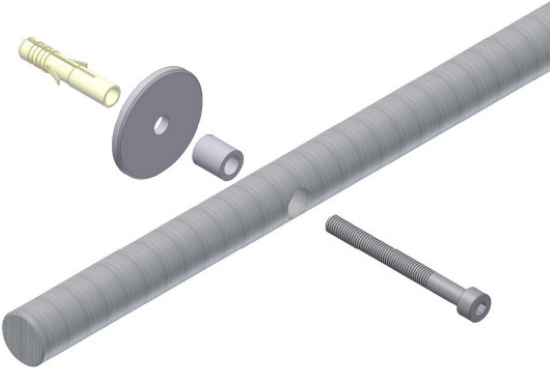
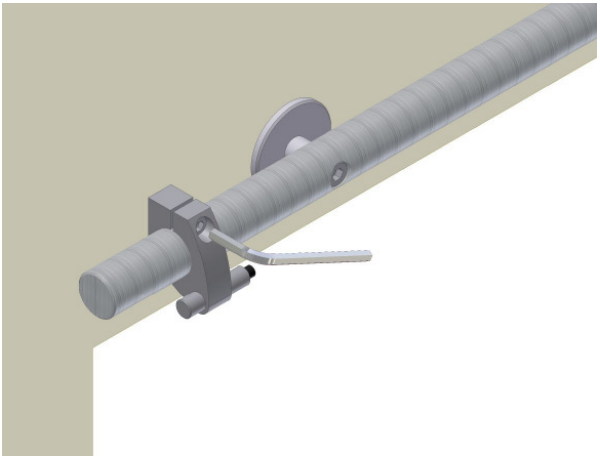
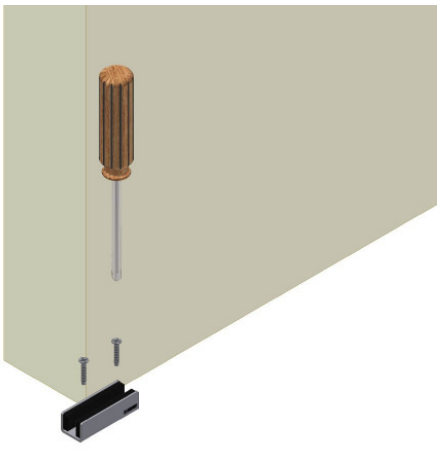
	<p>3 Wall Fastening of Runner Rail</p> <p>Mount runner rail to wall with MWE mounting material.</p>
	<p>4 Installation of Stopper</p> <p>Secure door stoppers on the left and on the right side of runner rail in a way that will prevent the sliding door from rolling off the rail.</p>
	<p>5 Installation of Floor Guide</p> <p>Install floor guide according to your planning detail using MWE installation material. Door leaf must run in a parallel line to wall in given distance.</p>

Installation Instruction

System Klassik (ST.1000.KL)

Am Steinbusch 7
D-48351 Everswinkel
Tel.: +49(0)2582-9960- 0
Fax: +49(0)2582-9960-28
Internet: www.mwe.de

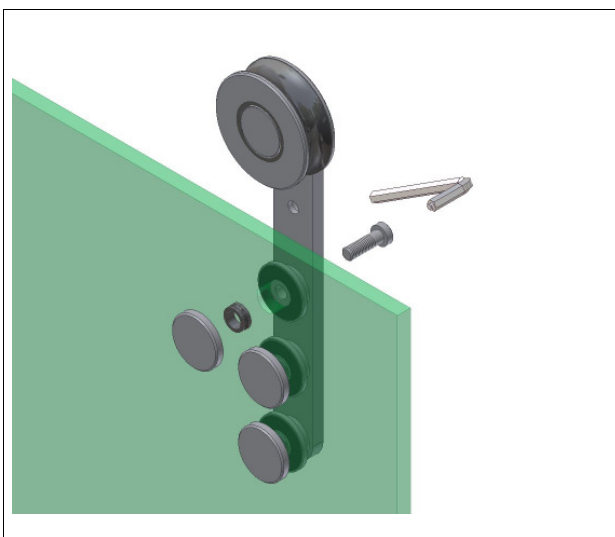
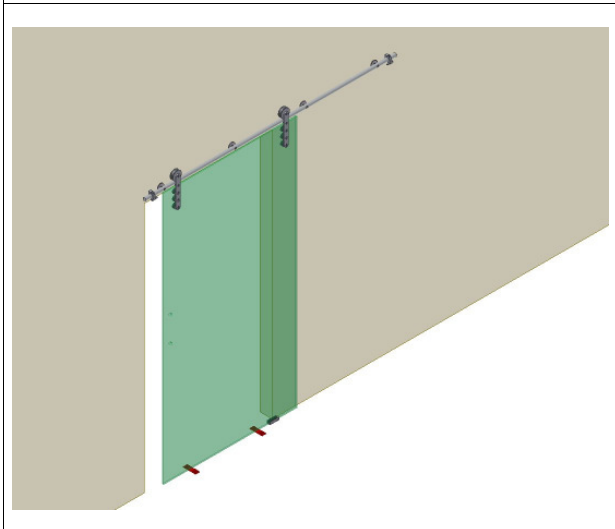
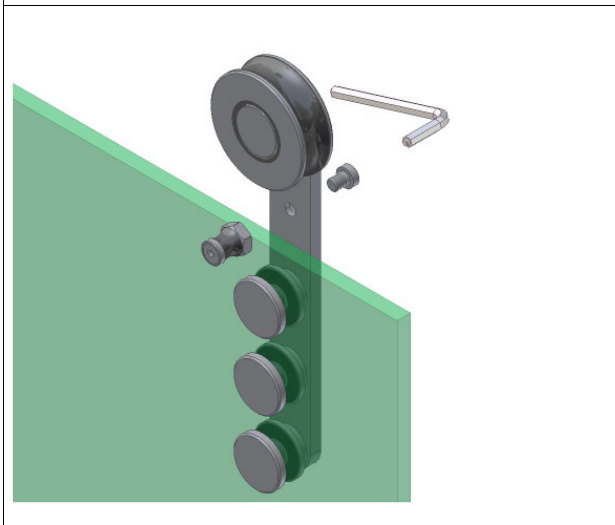
	<p>6 Installation of Roller</p> <p>Rest Door leaf on mounting rests with the hardware facing upwards. Disassemble roller, security bolt and glass mounts. Attention: security bolt and swivel joint form one single unit. Hold glass mount spacers to holes. Apply roller shank including mounting bolts and secure from the opposite side using the glass fastening covers. Attention: Do not lose plastic bushings of glass mounts.</p>
	<p>7 Mounting of Door Leaf</p> <p>Hang preassembled sliding door onto the runner rail. For safety reasons and for adjustment of floor distance (7 mm) put the glass shims on the floor underneath the door leaf. Note preassembled floor guide! Glass shims are to be removed eventually.</p>
	<p>8 Mounting of Safety Bolt</p> <p>Reassemble safety bolt to roller using jaw wrench (10 mm). Attention: Do not leave space between safety bolt and runner rail.</p>

Installation Instruction

System Klassik (ST.1000.KL)

Am Steinbusch 7
D-48351 Everswinkel
Tel.: +49(0)2582-9960- 0
Fax: +49(0)2582-9960-28
Internet: www.mwe.de

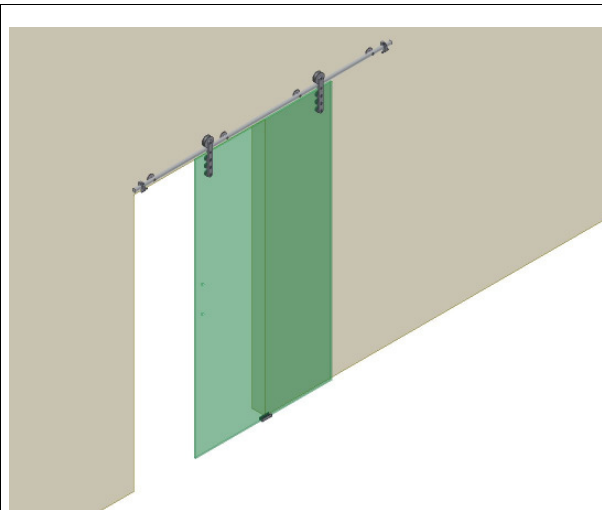

9

Final Control of Sliding Door

Control smooth movement of sliding door and function of final door stops. Adjust door stops if necessary. Secure stopper bolts tightly!
Install door handles or door knobs, respectively.

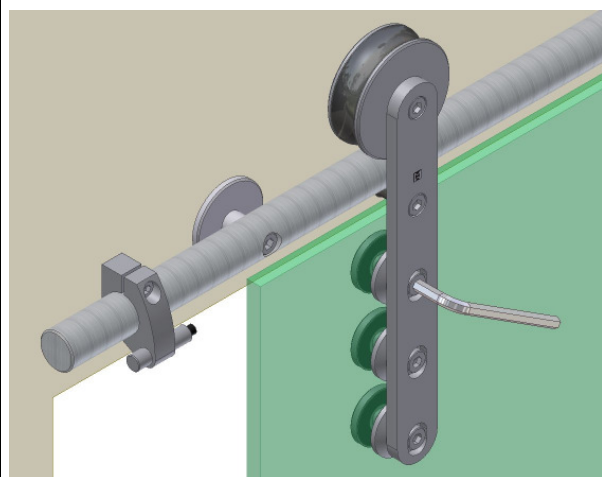

10

Tightening of Bolts

After completion of installation make sure that every single bolt is once again securely tightened!