



# COTTAGE BARN DOOR

## INSTALLATION INSTRUCTIONS



## COTTAGE DOOR Recommended Tools

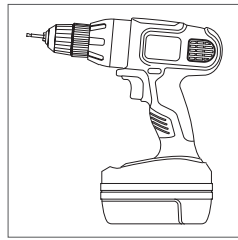

Drill with  
Phillips Bit

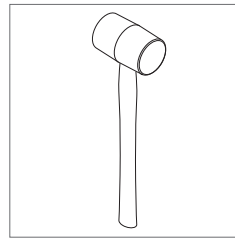

Rubber Mallet

## COTTAGE DOOR Parts

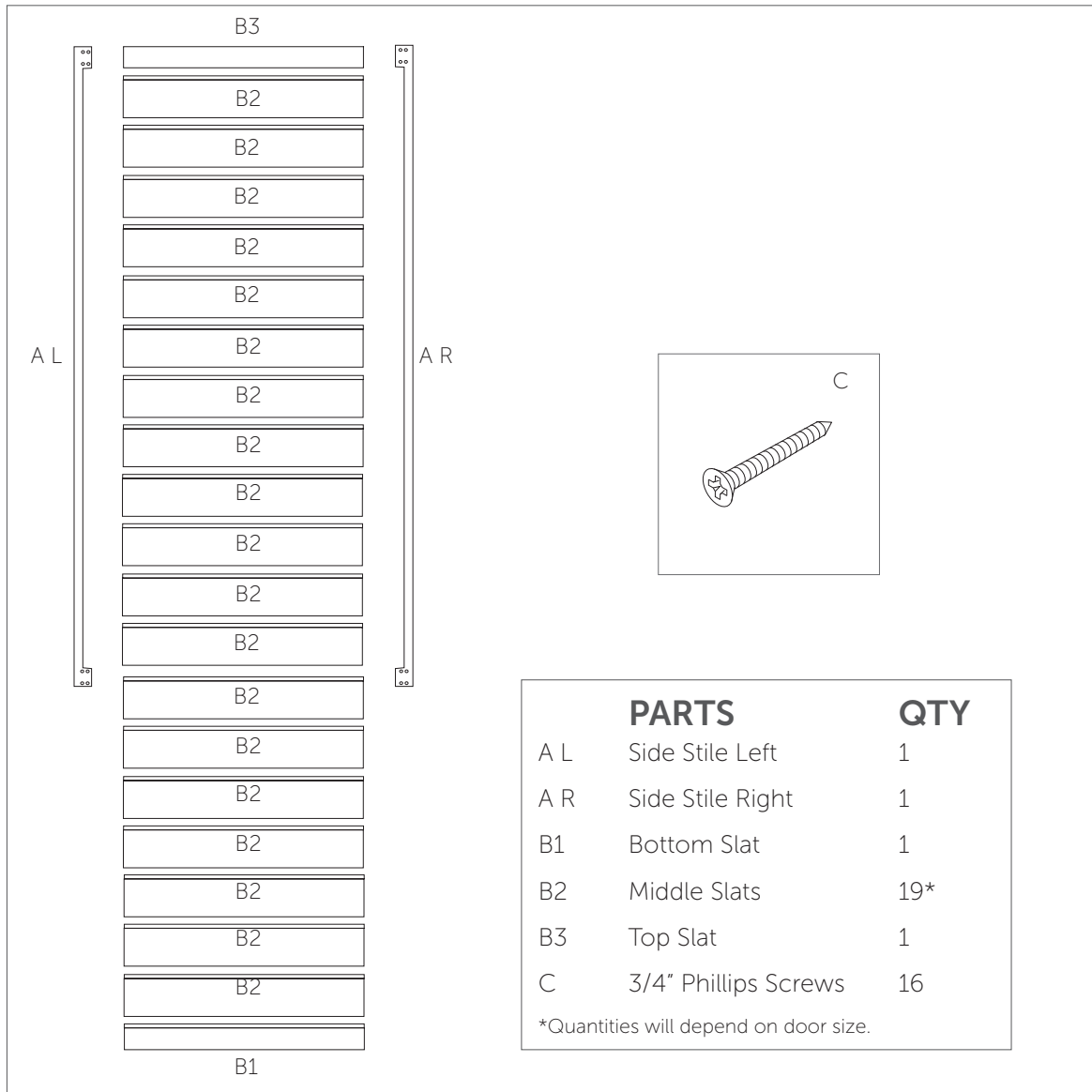

# COTTAGE DOOR Before You Begin

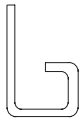
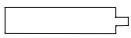
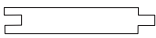
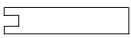
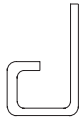
A L Stile	B1 Slat	All B2 Slats	B3 Slat	A R Stile
				

Slat and Stile End Views

## FIRST THINGS FIRST

Lay out all wood parts before beginning assembly to ensure parts have not been damaged in shipping. If damage has occurred, call 1(888) 909-6546 and BarnDoors & Hardware will expedite a replacement.

### NOTE:

This door model comes in various sizes. The instructions have been written for the average single door size; but larger doors may have more wood and fastener parts.

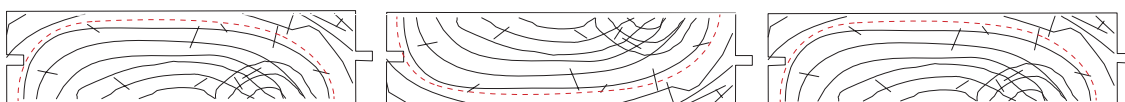

### NOTE:

Always alternate the direction of the wood grain when assembling slats. This will add strength to the assembly and help prevent warpage.

### NOTE:

Doors using Floor Mount Door Guides will have a groove on the bottom edge. Ensure this groove is on the bottom when hanging the door.

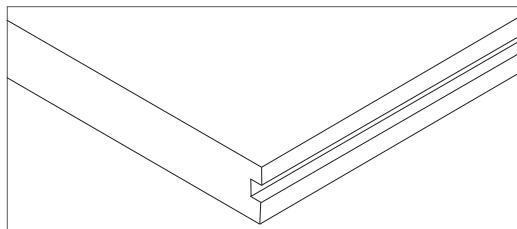

### NOTE:

The following should be a 'dry' assembly. Do not use adhesives in when putting this door together.

**Use teamwork. We recommend two people for this build.**



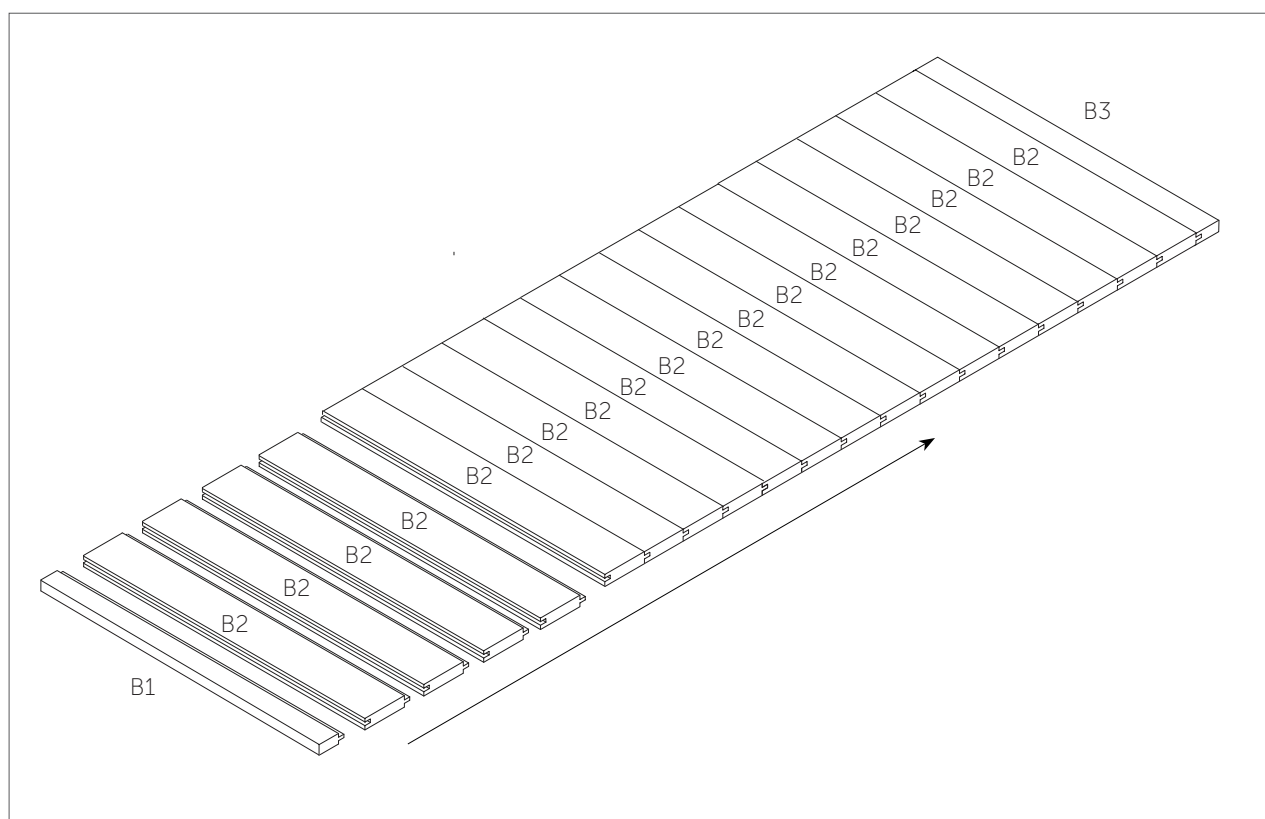
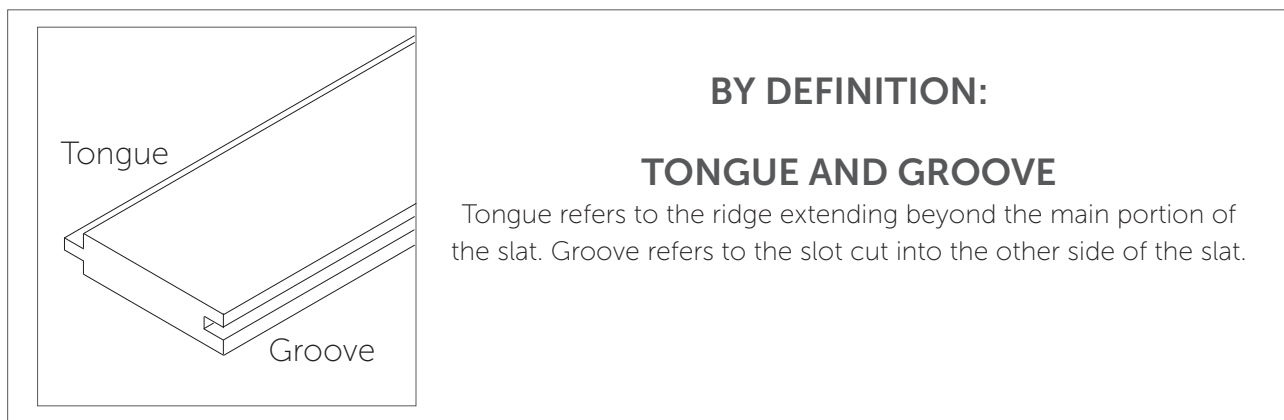

Figure 1

1. On a flat, clean, surface, lay the B3 slat upside down with the groove facing toward the bottom of the door assembly. Lay all B2 slats below B3 with the groove facing toward the bottom. Lay the B1 slat up side down at the bottom of the last B2 slat with the tongue facing toward the top of the door assembly. Assemble by fitting the tongue into the groove of each piece, tapping them together with a rubber mallet (Figure 1).

# COTTAGE DOOR Assembly Instructions

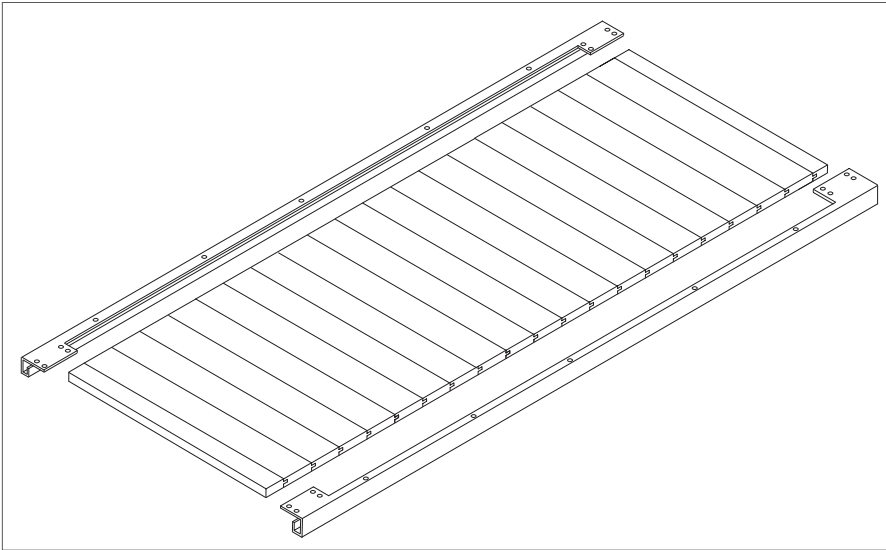
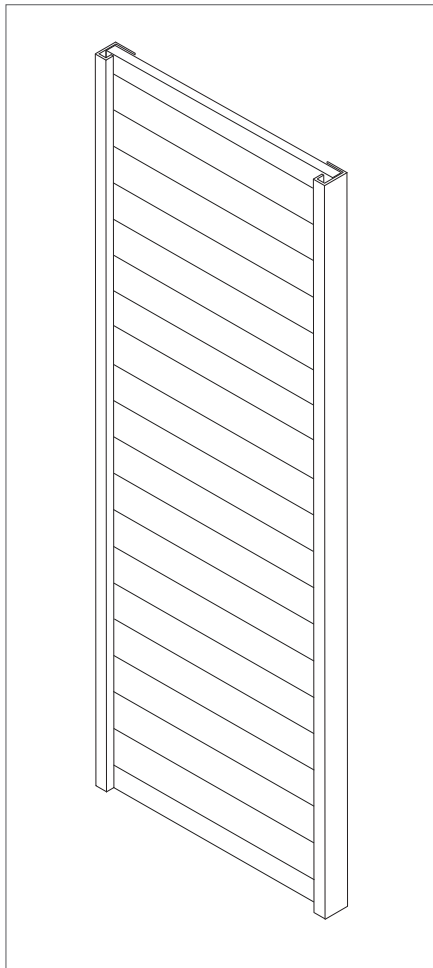

Figure 2

2. Attach stiles (AL and AR) with phillips screws (C) using a drill with a phillips bit to the back of the door (Figure 2).



The door is now ready for a pull installation or to be hung with your selection of hanger.



# WE LOVE WHAT YOU'RE DOING WITH THE PLACE

CONGRATULATIONS ON YOUR DECISION TO BRING HOME AN  
AMERICAN MADE PRODUCT OF THE HIGHEST QUALITY. WE HOPE YOUR  
COTTAGE BARN DOOR BRINGS ART AND FUNCTION INTO YOUR LIFE.

1-800-891-8312  
support@rustica.com  
www.Rustica.com

DESIGNED AND CRAFTED ENTIRELY IN THE  
**U.S.A.**



DON'T BE A STRANGER.  
FOLLOW US ON SOCIAL MEDIA.

