



RANCH DOOR

INSTALLATION INSTRUCTIONS



RANCH Recommended Tools

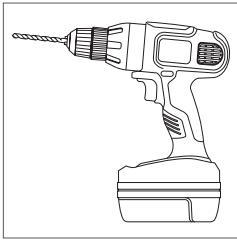

Drill with 1/8", 1/4" Drill Bits and Phillips Screw Bit

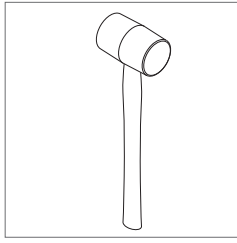

Rubber Mallet

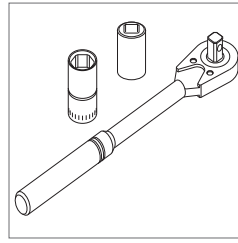

Socket Wrench with 7/16 and 9/16" Socket

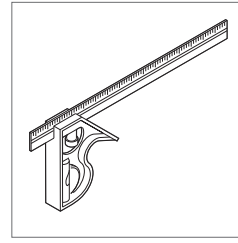

Adjustable Square

NOTE:

The following should be a 'dry' assembly. Do not use adhesives in when putting this door together.

NOTE:

If any of the slats have been damaged during shipping, call us at 800-891-8312 and we will expedite a replacement slat. Lay out your Door parts according to the illustration shown below to accurately identify which part needs to be replaced, if any.

RANCH Parts—Lay all parts out on a flat surface as shown here.

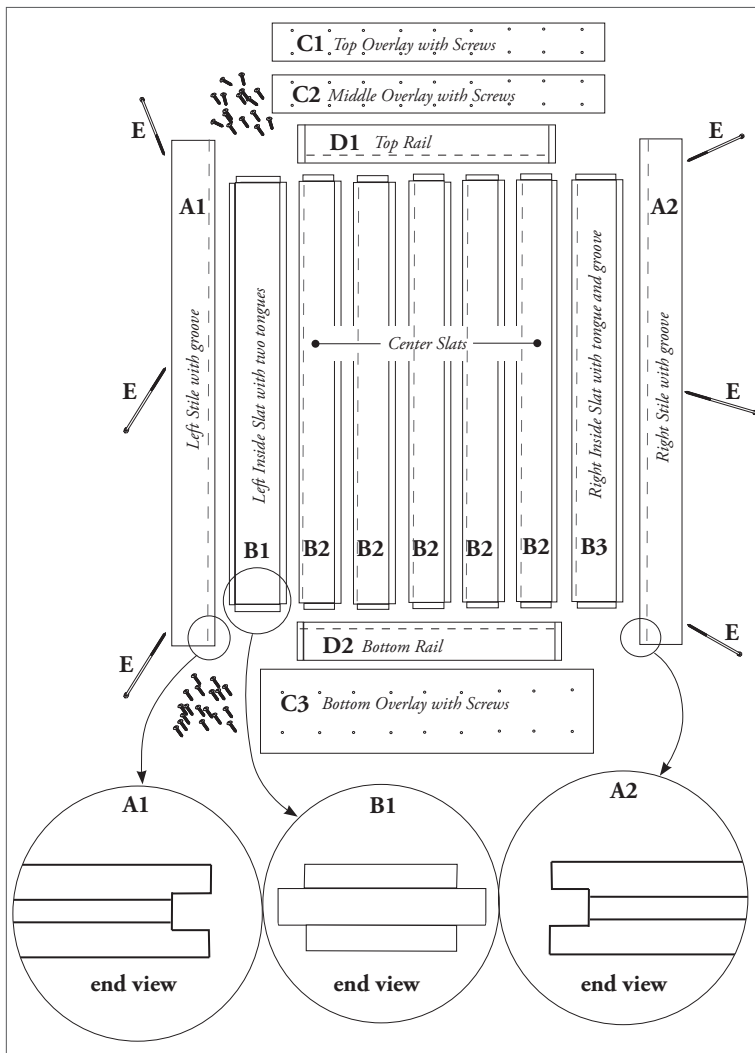

NOTE:

These instructions are specific to a particular door size and type. Adjustments may be needed on your part for changes in specifications and measurements, as well as door types that are different than these.

- A1 Left Stile with Groove
- B1 Left Inside Slats with 2 Side Tongues
- B2 Center Slats with 1 Tongue & 1 Groove
- B3 Right Inside Slats w/ 1 Tongue & 1 Groove
- A2 Right Stile with Groove
- C1 Top Overlay with Screws
- C2 Middle Overlay with Screws
- C3 Bottom Overlay with Screws
- D1 Top Rail
- D2 Bottom Rail
- E 6" Lag Bolts

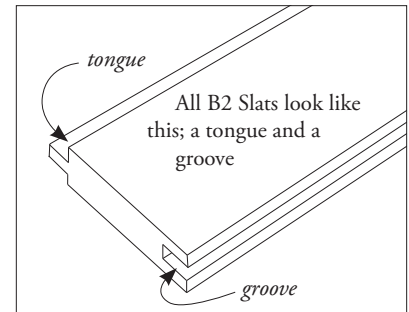

Use teamwork. We recommend two people for this build.

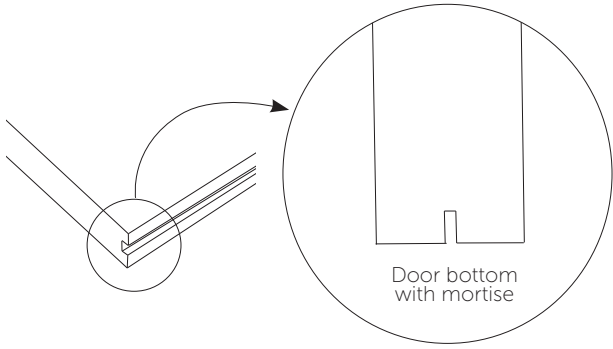

NOTE:
If you are installing a Floor Mount Door Guide, your door will have a mortise (a groove that runs along the bottom of your door). Make sure this mortise is facing down towards your floor and that you install the Door Hangers on the other end.

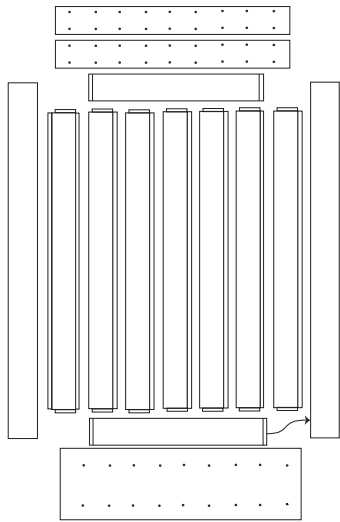

1. Slide Bottom Rail so the tongue inserts into the groove of the Side Stile.

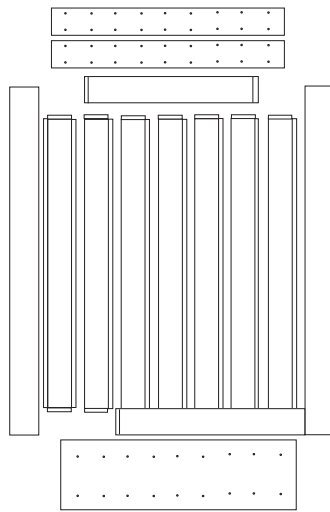

2. The tongues on the bottoms of the Center Slats will fit into the groove of the Bottom Rail.

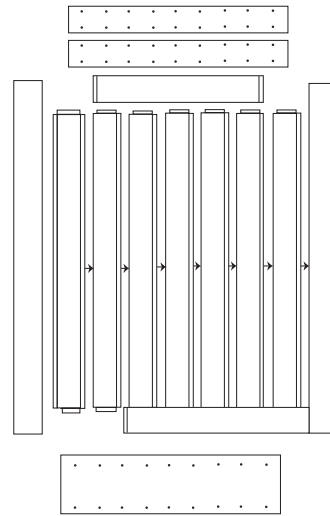

3. Slide each of the remaining Center Slats so the tongue of each slat nests inside the ove in the Slat next to it. Gently tap slats into place with a rubber mallet.

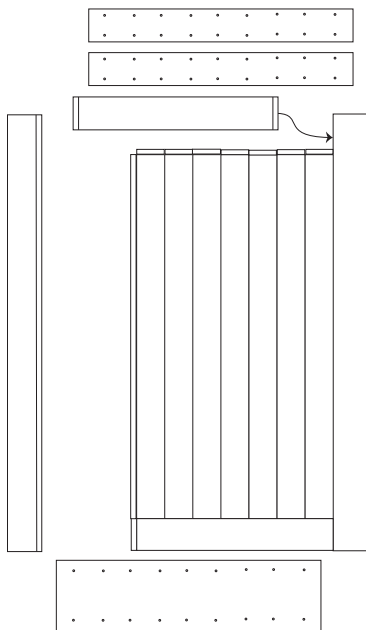

4. Slide the Top Rail so it's side tongue slides into the groove of the Side Stile, and its groove slides over the top tongues of the Center Slats.

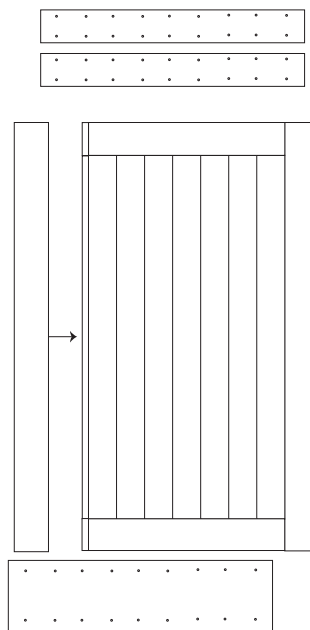

5. Slide the remaining Side Stile so the groove in it goes over the tongue the Center Slat next to it. Gently tap slats into place with a rubber mallet.



RANCH DOOR Assembly Instructions

6. Insert the Lag Bolts into the Side Stiles' pre-drilled holes. Tighten using a ratchet with a 7/16" socket.

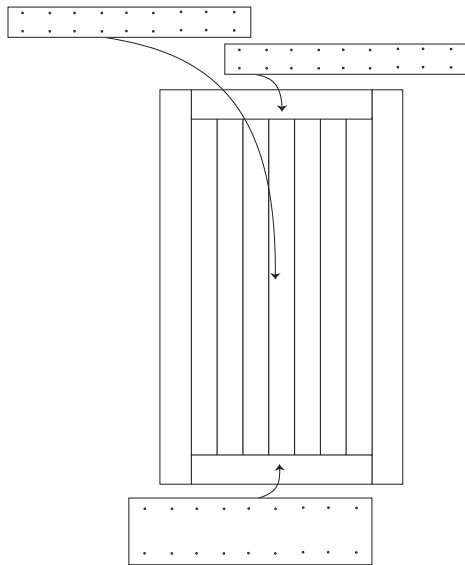
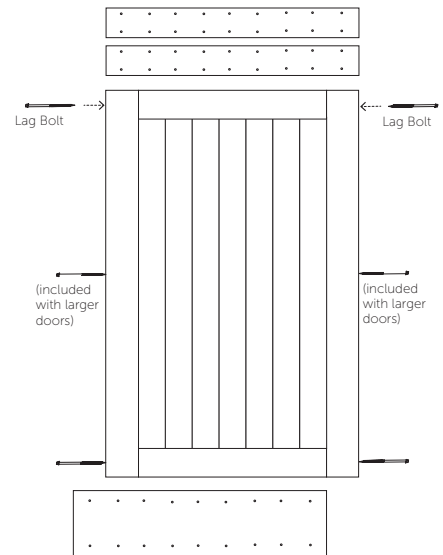

7. Slide the Top, Center, and Bottom Overlays into place, aligning the edges with the Door's outside edges. Attach with Grabber Screws and a drill with a Phillips bit.

NOTE:

It is very important that the Lag Bolts remain absolutely horizontal while being drilled into the Door's Stiles, not at an angle in any direction.

Congratulations on the assembly of your amazing RANCH Door. We are always here to help. If you have questions, please call us for assistance.

Attach a Door Pull and your Door is ready to hang.

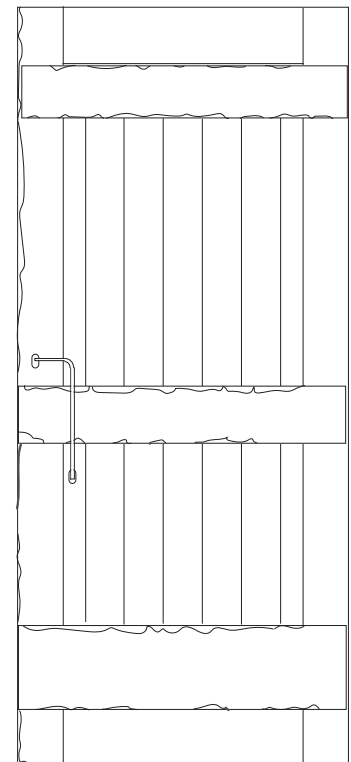

WE LOVE WHAT YOU'RE DOING WITH THE PLACE

CONGRATULATIONS ON YOUR DECISION TO BRING HOME
AN AMERICAN MADE PRODUCT OF THE HIGHEST QUALITY.
WE HOPE YOUR RANCH DOOR BRINGS
ART AND FUNCTION INTO YOUR LIFE.

1-800-891-8312
support@rustica.com
www.Rustica.com

DESIGNED AND CRAFTED ENTIRELY IN THE
U.S.A.



DON'T BE A STRANGER.
FOLLOW US ON SOCIAL MEDIA.

