

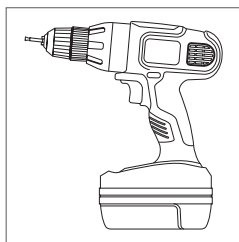

# TWO PANEL DOOR INSTALLATION INSTRUCTIONS



## TWO PANEL DOOR Recommended Tools



Drill with Phillips Bit

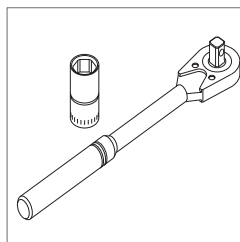

Socket Wrench with 7/16" Socket

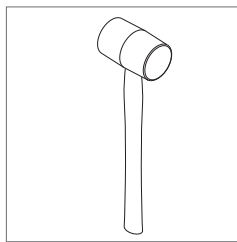

Rubber Mallet

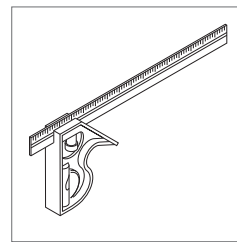

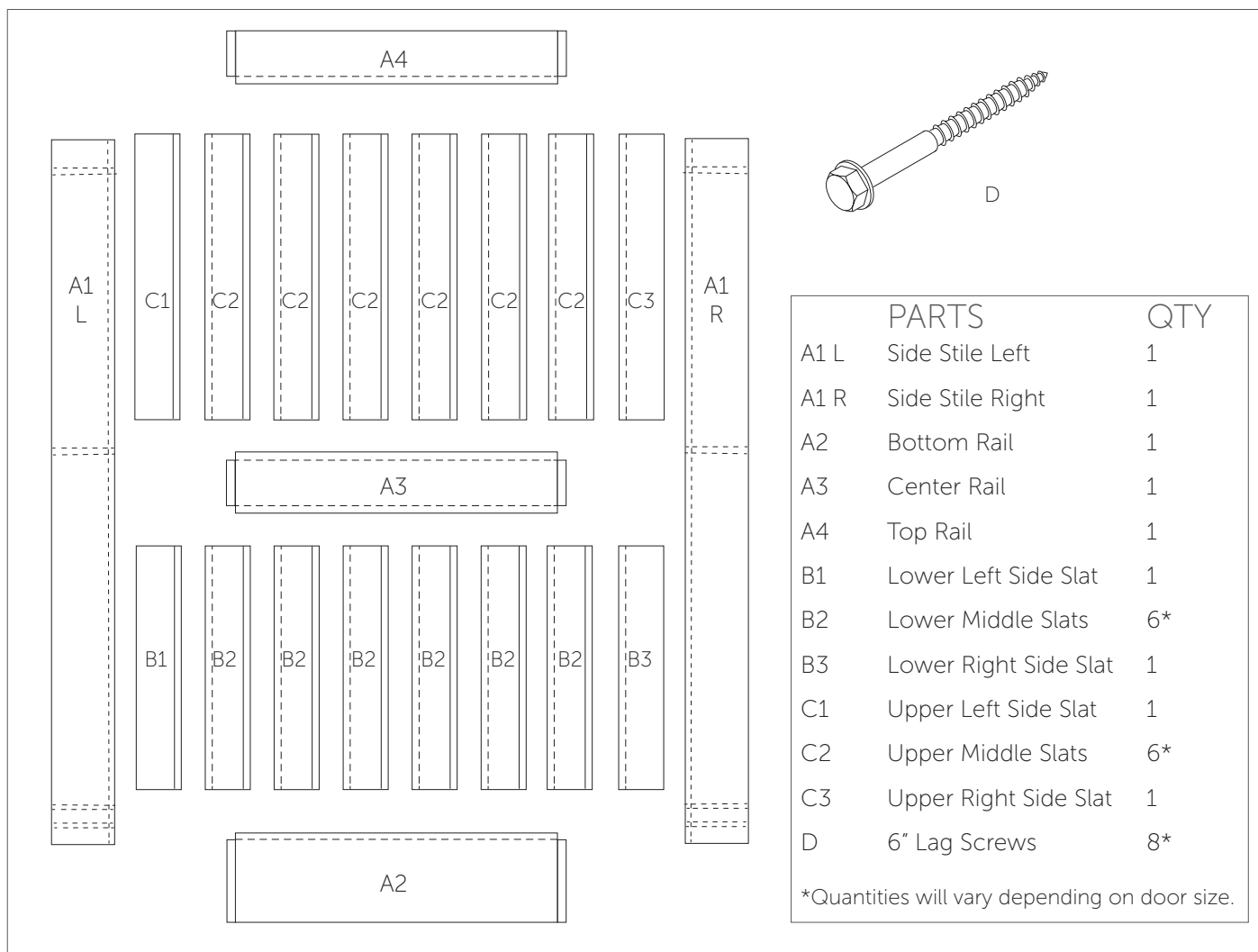

Adjustable Square

## TWO PANEL DOOR Parts

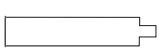
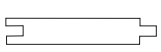
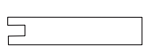

## TWO PANEL DOOR Before You Begin

A L Stile	B1/C1 Slat	All B2/C2 Slats	B3/C3 Slat	A R Stile
				

Slat and Stile End Views

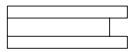
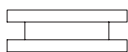
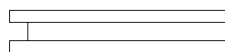
Top Rail	Middle Rail	Bottom Rail
		

Rail End Views

### FIRST THINGS FIRST

Lay out all wood parts before beginning assembly to ensure parts have not been damaged in shipping. If damage has occurred, call 800-891-8312 and Rustica Hardware will expedite a replacement.

#### NOTE:

This door model comes in various sizes. The instructions have been written for the average single door size; but larger doors may have more wood and fastener parts.

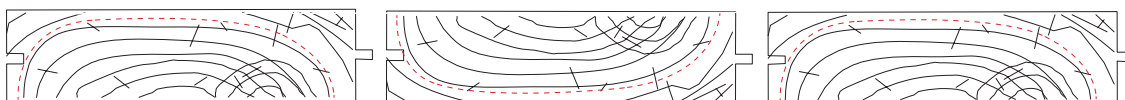

#### NOTE:

Always alternate the direction of the wood grain when assembling slats. This will add strength to the assembly and help prevent warpage.

#### NOTE:

Doors using Floor Mount Door Guides will have a groove on the bottom edge. Ensure this groove is on the bottom when hanging the door.

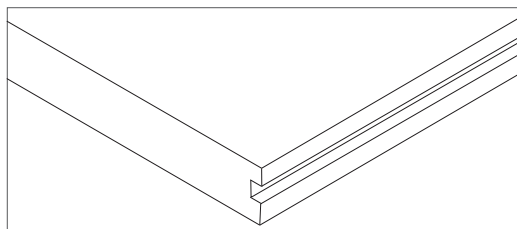

**Use teamwork. We recommend two people for this build.**



# TWO PANEL DOOR Assembly Instructions

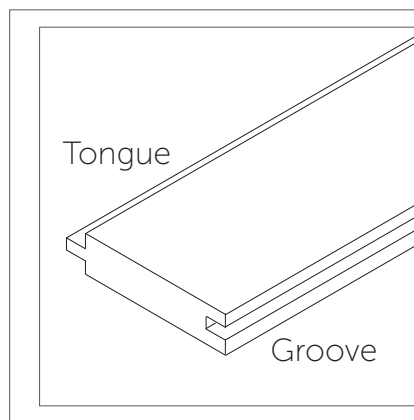

## BY DEFINITION:

### TONGUE AND GROOVE

Tongue refers to the ridge extending beyond the main portion of the slat. Groove refers to the slot cut into the other side of the slat.

## NOTE:

The following should be a 'dry' assembly. Do not use adhesives in when putting this door together.

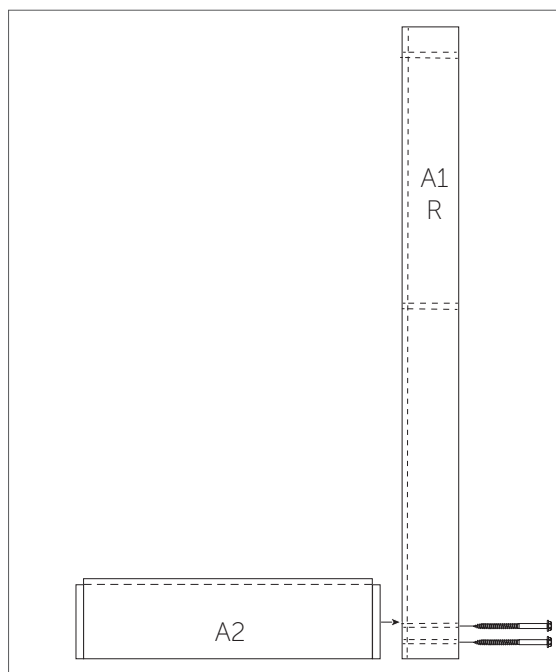

Figure 1

1. Using a rubber mallet, gently tap the lower rail (A2) into the bottom of the right stile rail (A1R) . Attach the bottom rail to the side stile using a socket wrench with a 7/16" socket and two lag screws (D) (Figure 1).

## SUGGESTION

Use an adjustable or fixed carpenter's square to ensure all sides of the door are square to each other.

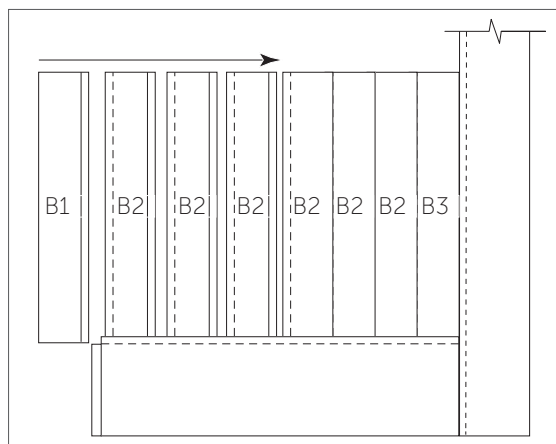

Figure 2

2. Beginning with the lower right side slat (B3) slide the lower slats (B2) with the tongue facing to the right, into the groove of the bottom rail one at a time, ending with the lower left side slat (B1). Tap each in place with the rubber mallet (Figure 2).



## TWO PANEL DOOR Assembly Instructions

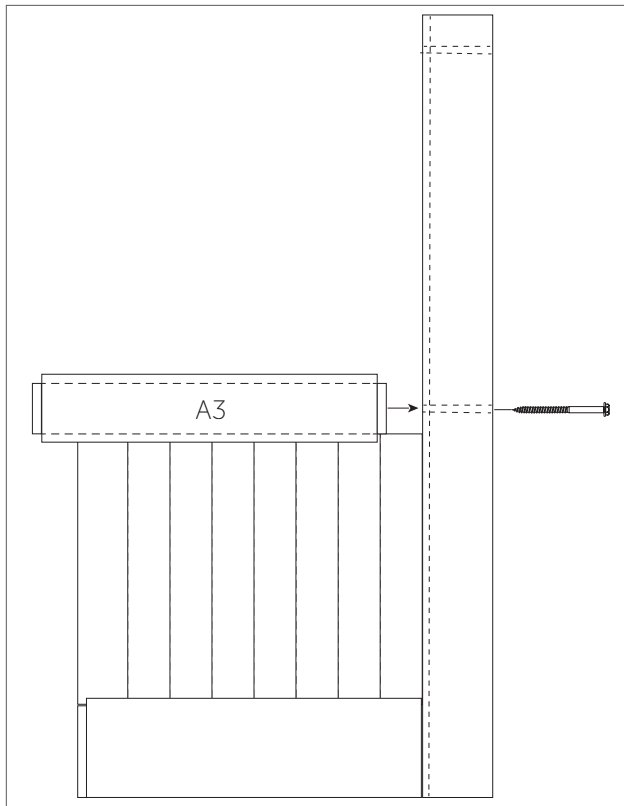

Figure 3

3. Slide the center rail (A3) lower groove over the top of the lower slats. Tap with a rubber mallet into the right side stile. Attach the middle rail to the right side rail using a socket wrench with a 7/16" socket and one lag screw (D) (Figure 3).

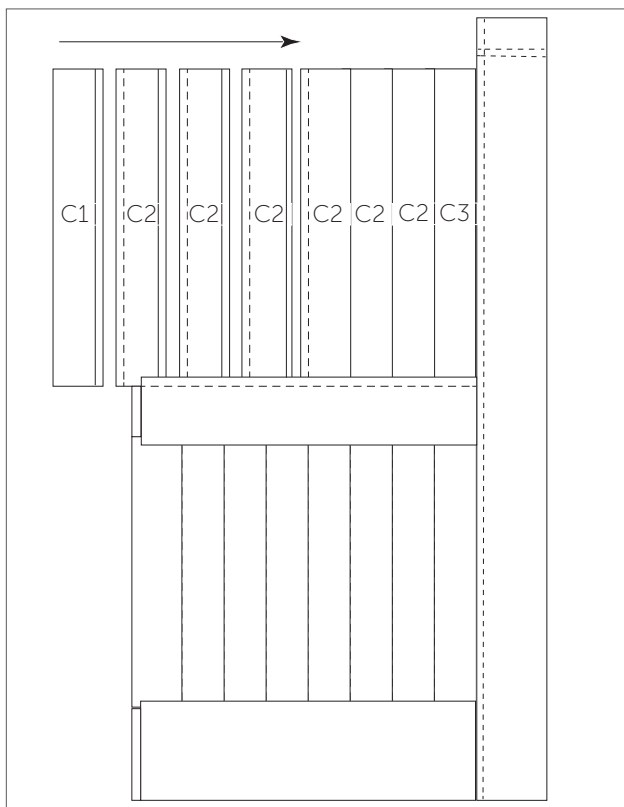

Figure 4

4. Beginning with the upper right side slat (C3) slide the upper slats (C2) into the groove of the center rail (A3) one at a time, ending with the upper left side slat (C1). Tap each in place with the rubber mallet (Figure 4).



## TWO PANEL DOOR Assembly Instructions

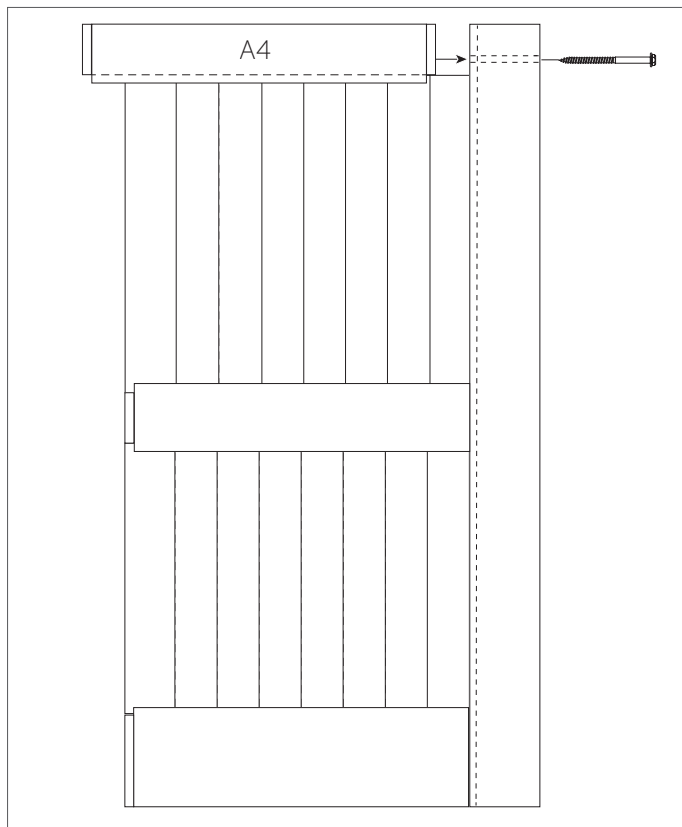

Figure 5

5. Slide the top rail (A4) lower groove over the top of the upper slats. Tap with a rubber mallet into the right side rail. Attach the upper rail to the right side stile using a socket wrench with a 7/16" socket and one lag screw (D) (Figure 5).

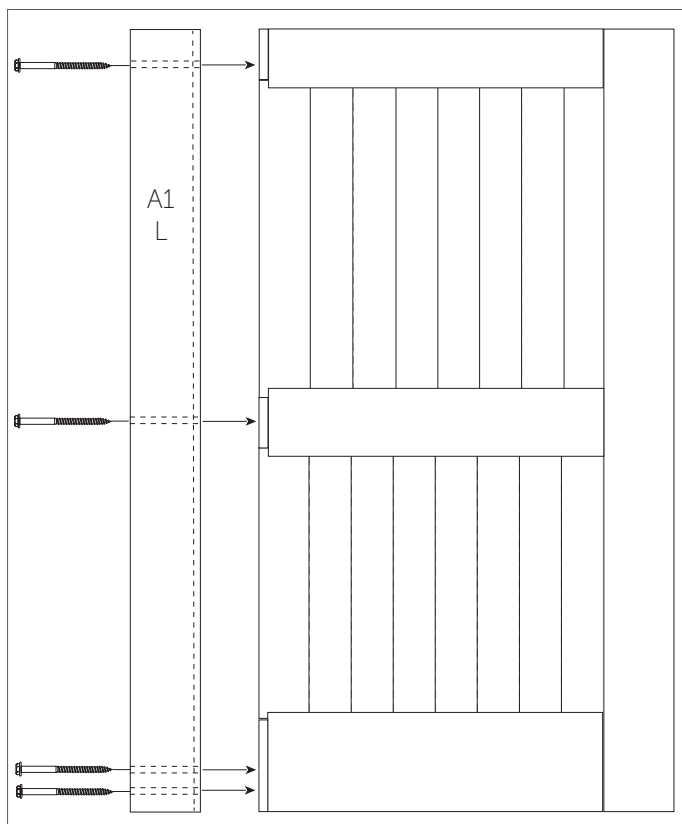

Figure 6

6. Carefully align the left side stile (A1L) to the top, middle, and bottom rails and the top and bottom slats. Gently tap in place with a rubber mallet. Attach to the top, middle, and bottom rails using a socket wrench with a 7/16" socket and the remaining 4 lag screws (D) (Figure 6).



# WE LOVE WHAT YOU'RE DOING WITH THE PLACE

CONGRATULATIONS ON YOUR DECISION TO BRING HOME  
AN AMERICAN MADE PRODUCT OF THE HIGHEST QUALITY. WE HOPE  
YOUR TWO PANEL DOOR BRINGS ART AND FUNCTION INTO YOUR LIFE.

1-800-891-8312  
support@rustica.com  
www.Rustica.com

DESIGNED AND CRAFTED ENTIRELY IN THE  
**U.S.A.**



DON'T BE A STRANGER.  
FOLLOW US ON SOCIAL MEDIA.

