



Z BARN DOOR

INSTALLATION INSTRUCTIONS



Z BARN DOOR Recommended Tools

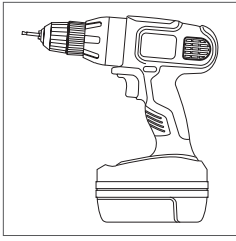

Drill with Phillips Bit

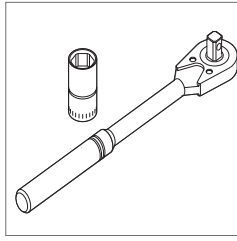

Socket Wrench
with 7/16" Socket

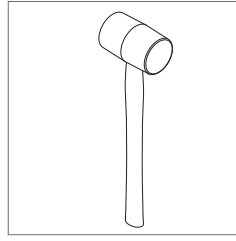

Rubber Mallet

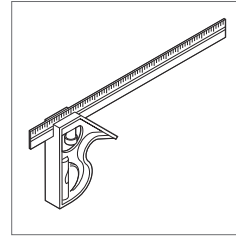

Adjustable Square

Z BARN DOOR Parts

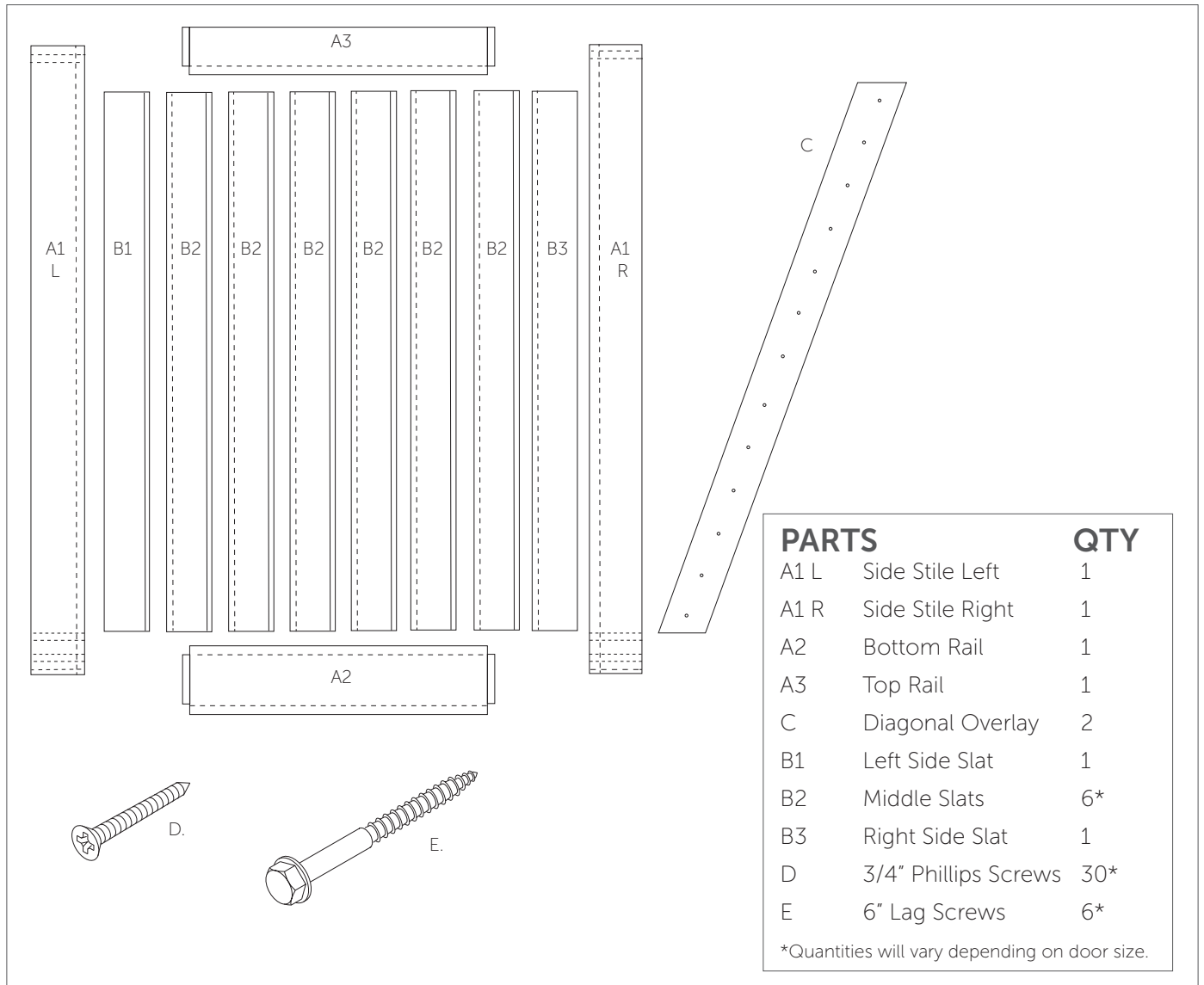

Z BARN DOOR Parts

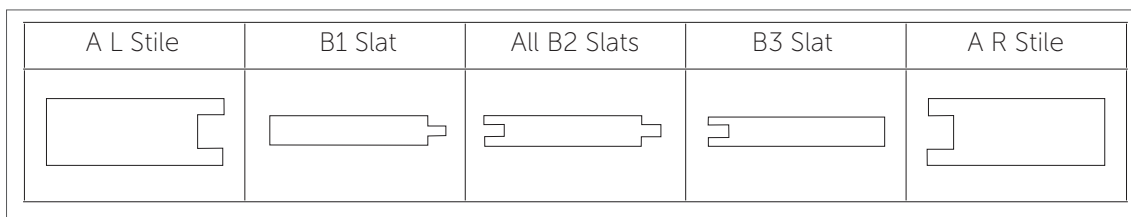

Slat and Stile End Views

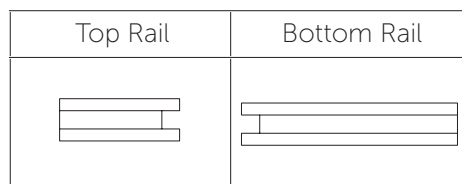

Rail End Views

FIRST THINGS FIRST

Lay out all wood parts before beginning assembly to ensure parts have not been damaged in shipping. If damage has occurred, call 800-891-8312 and Rustica Hardware will expedite a replacement.

NOTE:

This door model comes in various sizes. The instructions have been written for the average single door size; but larger doors may have more wood and fastener parts.

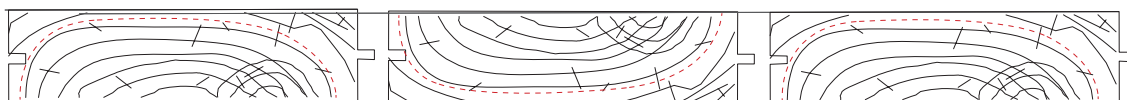

NOTE:

Always alternate the direction of the wood grain when assembling slats. This will add strength to the assembly and help prevent warpage.

NOTE:

Doors using Floor Mount Door Guides will have a groove on the bottom edge. Ensure this groove is on the bottom when hanging the door.

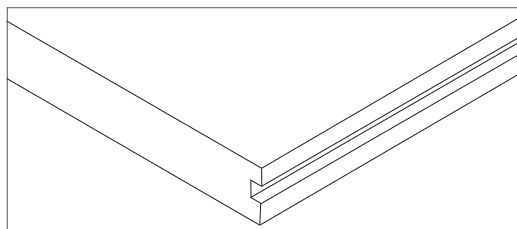

Use teamwork. We recommend two people for this build.



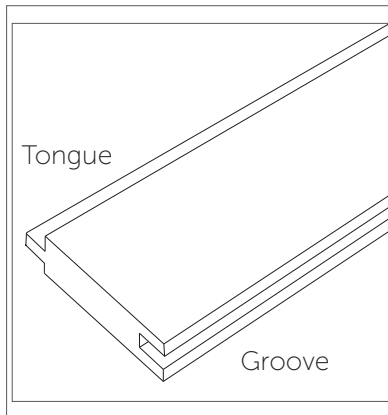

BY DEFINITION:

TONGUE AND GROOVE

Tongue refers to the ridge extending beyond the main portion of the slat or stile. Groove refers to the slot cut into the other side of the slat or stile.

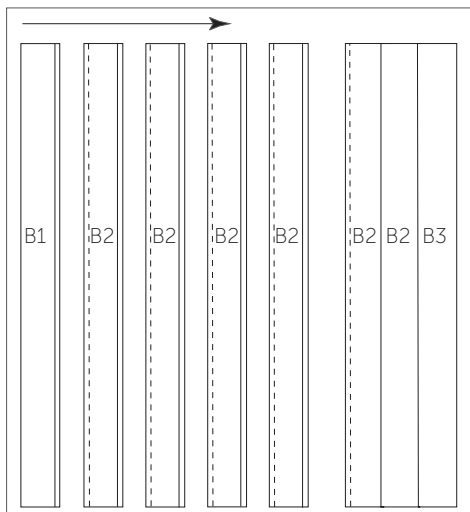

Figure 1

1. On a flat, clean surface, lay out the right slat (B3) with the groove facing to the left. Lay all middle slats (B2) next to B3 with the tongue facing to the left. Lay the left slat (B1) to the left of the last B2 slat with the groove facing right. Assemble by fitting the tongue into the groove of each piece. Gently tap into place with a rubber mallet to seat the slats together (Figure 1).

NOTE:

The following should be a 'dry' assembly. Do not use adhesives in when putting this door together.

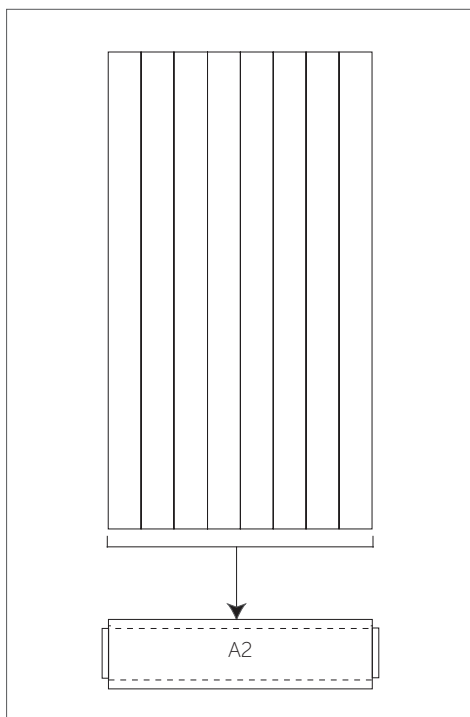

Figure 2

SUGGESTION:

Use an adjustable or fixed carpenter's square to ensure all sides of the door are square to each other.

2. Place the bottom rail (A2) below the assembled slats. Slide upward to cover the lower edge of the slat assembly. Tap the bottom rail into place with a rubber mallet (Figure 2).



Z BARN DOOR Assembly Instructions

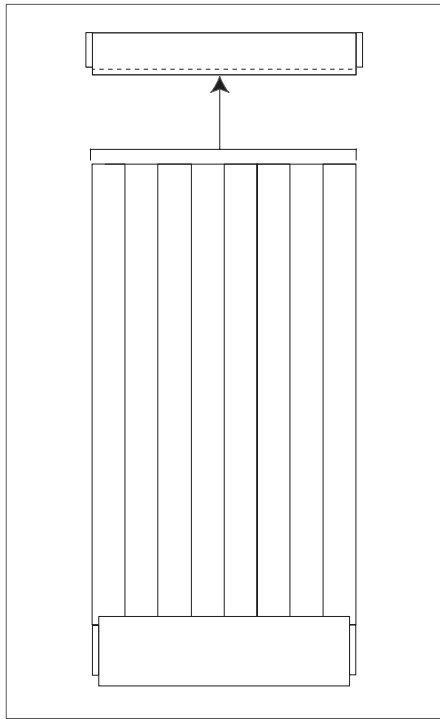

Figure 3

3. Place the Top Rail (A3) above the assembled slats. Slide downward to cover the upper edge of the slat assembly. Tap the Top Rail into place with a rubber mallet (Figure 3).

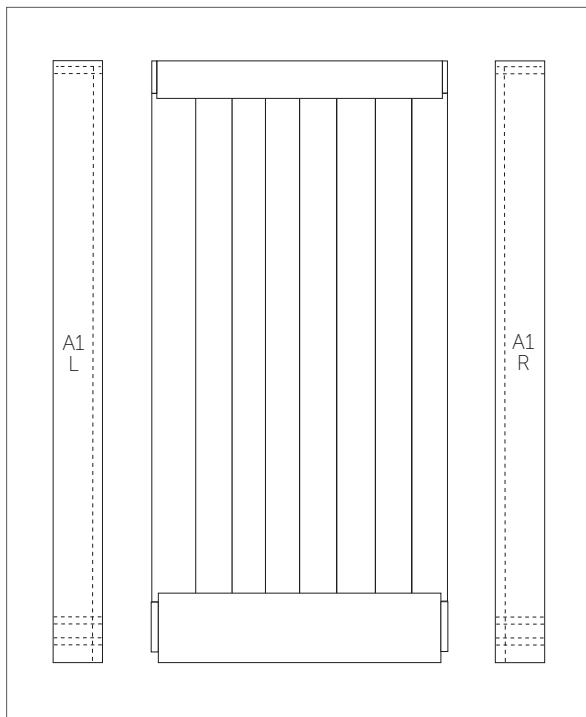

Figure 4

4. Place the left side stile (A1-L) beside the assembled slats and rails. Slide to the right to cover the top and bottom rail tongues and the edge of the slat assembly. Tap the rails into place with a rubber mallet. Repeat with the right stile (A1-R) (Figure 4).



Z BARN DOOR Assembly Instructions

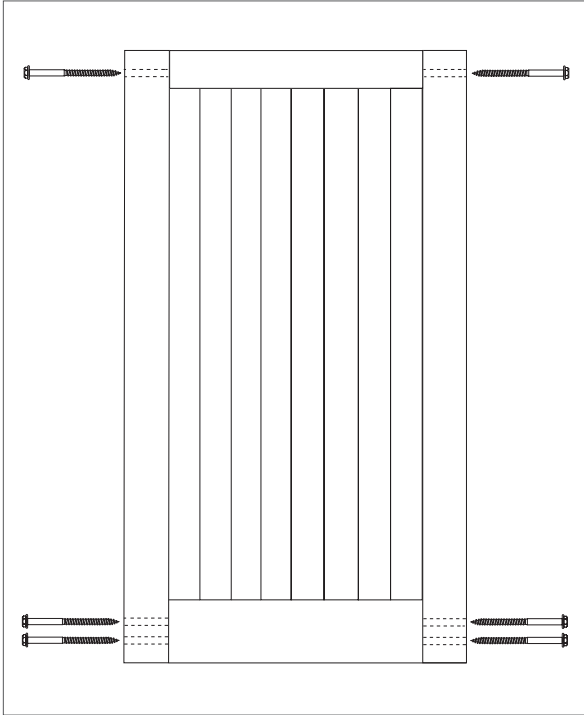

Figure 5

5. Fix the door assembly with six 6" lag screws (E), using a socket wrench with a 7/16" socket (Figure 5).

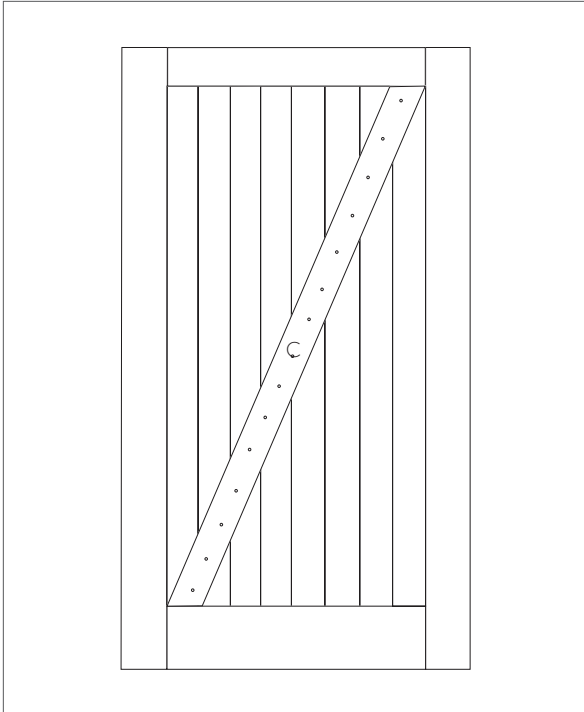

Figure 6

6. Lay the Diagonal Overlay (C) across the slats. Attach to slats and with phillips screws (D) using a drill with a phillips bit (Figure 6).

7. Turn the door over. Repeat step six for the other side.



WE LOVE WHAT YOU'RE DOING WITH THE PLACE

CONGRATULATIONS ON YOUR DECISION TO BRING HOME AN AMERICAN
MADE PRODUCT OF THE HIGHEST QUALITY. WE HOPE YOUR Z BARN
DOOR BRINGS ART AND FUNCTION INTO YOUR LIFE.

1-800-891-8312
support@rustica.com
www.Rustica.com

DESIGNED AND CRAFTED ENTIRELY IN THE
U.S.A.



DON'T BE A STRANGER.
FOLLOW US ON SOCIAL MEDIA.

