



# LEWISTON DOOR

## INSTALLATION INSTRUCTIONS



# LEWISTON DOOR Recommended Tools

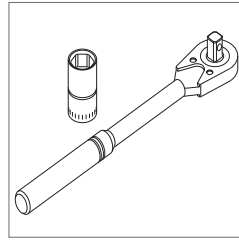

Socket Wrench  
with 7/16" Socket

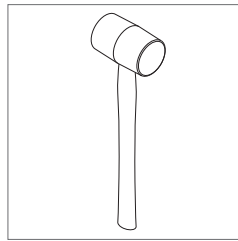

Rubber Mallet

# LEWISTON DOOR Parts

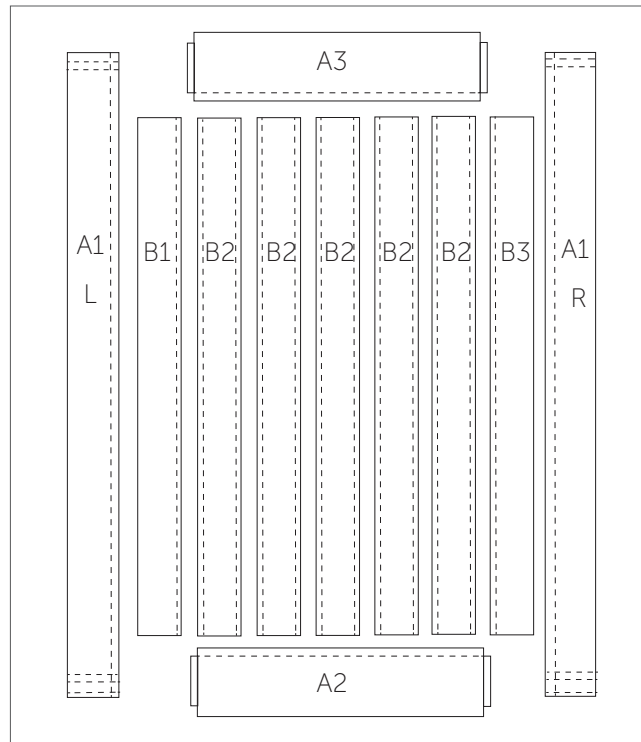

Door Parts

A L Stile	B1 Slat	All B2 Slats	B3 Slat	A R Stile

Slat and Stile End Views



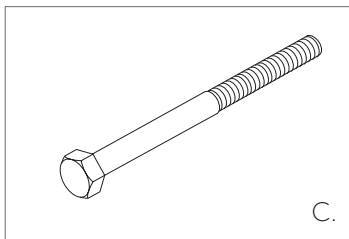

	<b>DESCRIPTION</b>	<b>QTY</b>
A1 L	Side Stile Left	1
A1 R	Side Stile Right	1
A2	Bottom Rail	1
A3	Top Rail	1
B1	Left Side Slat	1
B2	Middle Slats	5*
B3	Right Side Slat	1
C	6" Lag Bolts	4*

\*Quantities will vary depending on door size.

### FIRST THINGS FIRST

Lay out all wood parts before beginning assembly to ensure parts have not been damaged in shipping. If damage has occurred, call 800-891-8312 and Rustica Hardware will expedite a replacement.

This door model comes in various sizes. The instructions have been written for the average single door size; but larger doors may have more wood and fastener parts.

<p><b>NOTE:</b></p> <p>Doors using Floor Mount Door Guides will have a groove on the bottom edge. Ensure this groove is on the bottom when hanging the door.</p>	
--	--

**Use teamwork. We recommend two people for this build.**



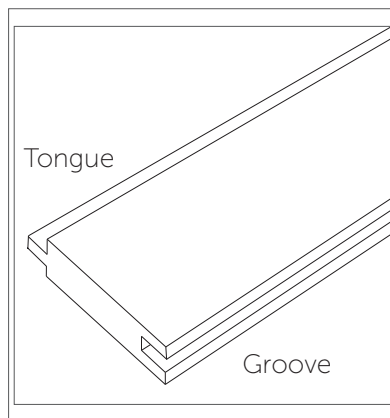

**BY DEFINITION:**

**TONGUE AND GROOVE**

Tongue refers to the ridge extending beyond the main portion of the slat or stile. Groove refers to the slot cut into the other side of the slat or stile.

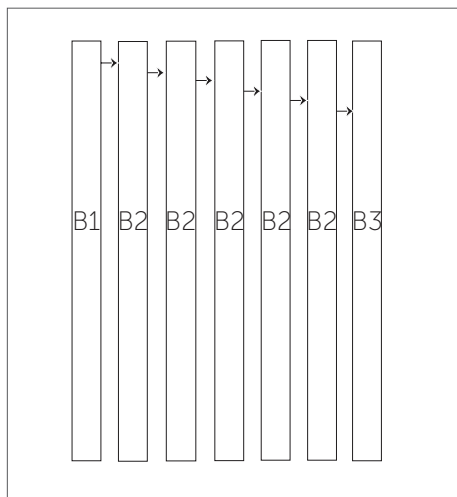

Figure 1

1. On a flat, clean surface, lay out the B1 slat with the tongue facing to the right. Lay all B2 slats next to B1 with the tongue facing to the right. Lay B3 to the right of the last B2 Slat with the groove facing left. Assemble by fitting the tongue into the groove of each piece (Figure 1).

**NOTE:**

The following should be a 'dry' assembly. Do not use adhesives in when putting this door together.

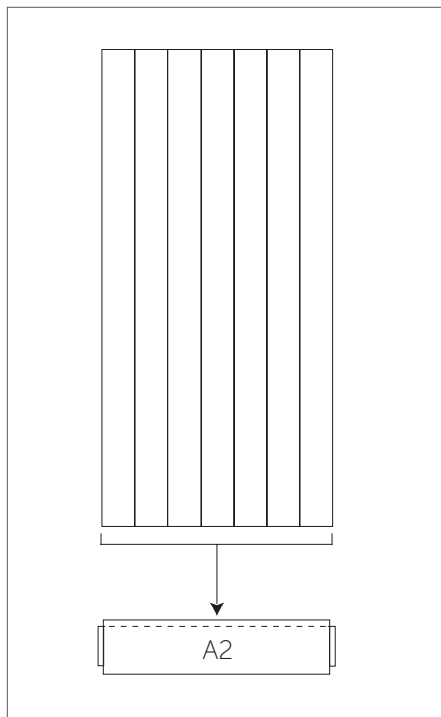

Figure 2

2. Place the Bottom Rail (A2) below the assembled slats. Slide upward to cover the lower edge of the slat assembly. Tap the Bottom Rail into place with a rubber mallet (Figure 2).



# LEWISTON DOOR Assembly Instructions

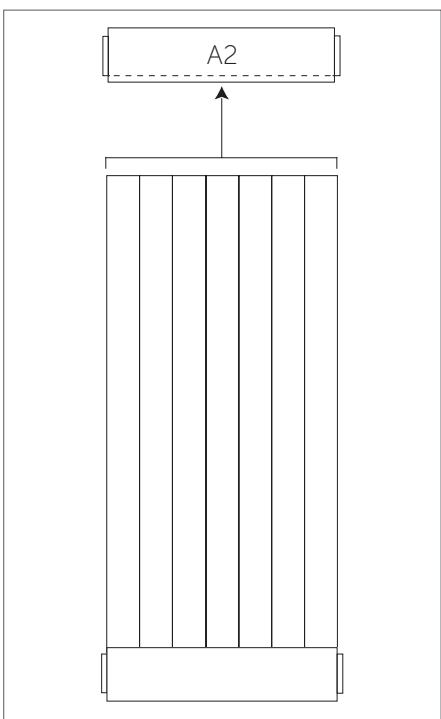

Figure 3

3. Place the Top Rail (A2) above the assembled slats. Slide downward to cover the upper edge of the slat assembly. Tap the Top Rail into place with a rubber mallet (Figure 3).

4. Place the left Stile (A1 L) beside the assembled slats and rails. Slide to the right to cover the rail tongues and the edge of the slat assembly. Tap the stile into place with a rubber mallet. Repeat with the right stile (A1 R) (Figure 4).

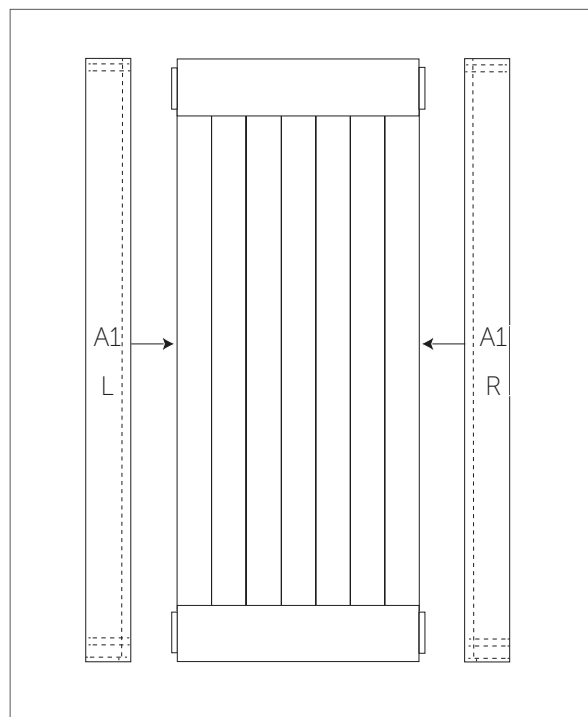
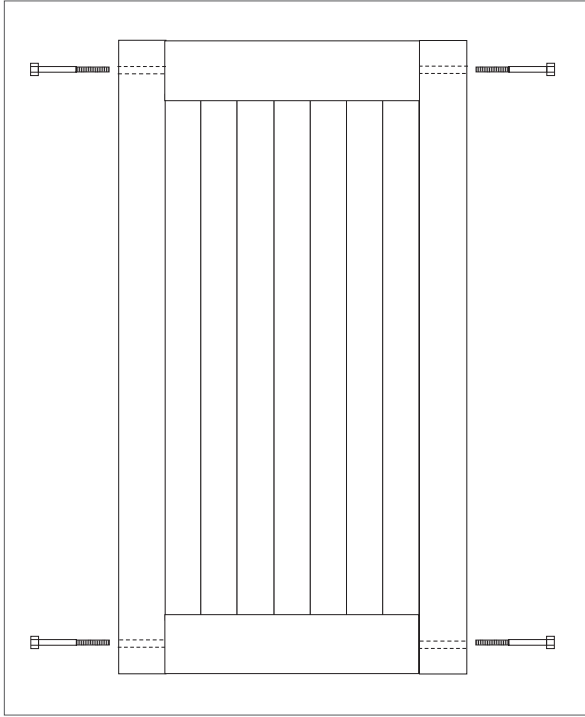

Figure 4



# LEWISTON DOOR Assembly Instructions



5. Fix the door assembly with four 6" lag bolts (provided), using a socket wrench with a 7/16" socket (Figure 5).

Figure 5



# WE LOVE WHAT YOU'RE DOING WITH THE PLACE

CONGRATULATIONS ON YOUR DECISION TO BRING HOME  
AN AMERICAN MADE PRODUCT OF THE HIGHEST QUALITY.  
WE HOPE YOUR LEWISTON DOOR BRINGS  
ART AND FUNCTION INTO YOUR LIFE.

1-800-891-8312  
support@rustica.com  
www.Rustica.com

DESIGNED AND CRAFTED ENTIRELY IN THE  
**U.S.A.**



DON'T BE A STRANGER.  
FOLLOW US ON SOCIAL MEDIA.

