

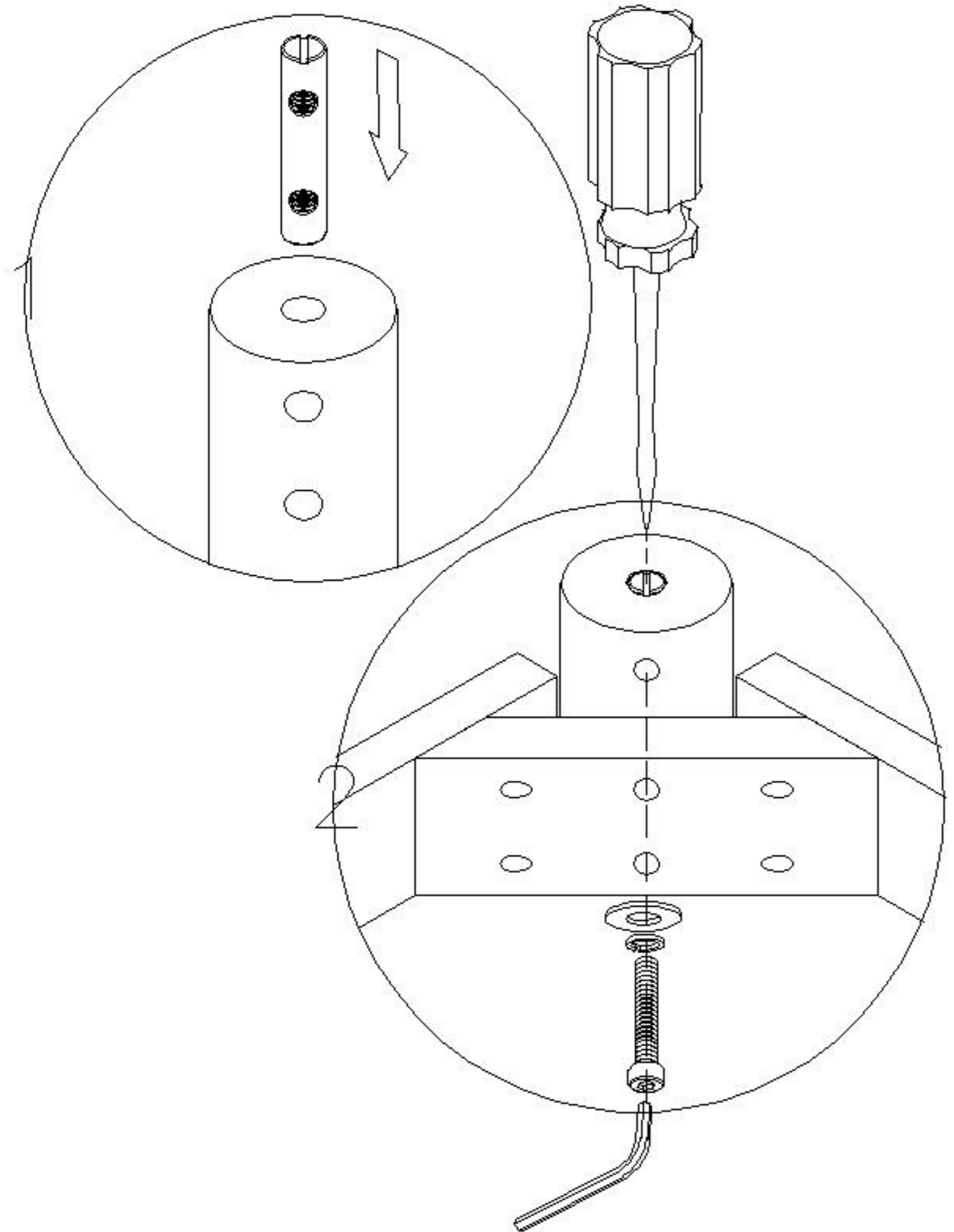





PK2R-A (1.4m)

安装方法/  
Installation method

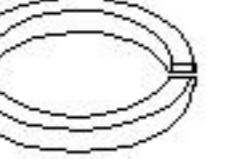
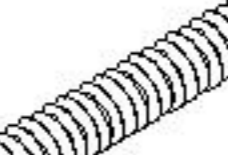

双孔锤母  
Double hole hammer nut

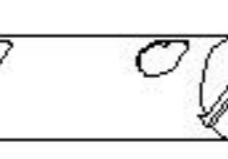
-  (A)\*4
-  (C)\*8
-  (D)\*8
-  (E)\*8
-  (B)\*1
-  (F)\*4

