

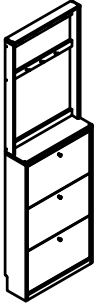







米悦鞋柜（超薄翻门）组装示意图

	组 装 五 金	 A=2	M6  B=4	L4  C=1	 D=2	6*80  E=2	4*16  F=2	M6  G=4	

①连接上下节

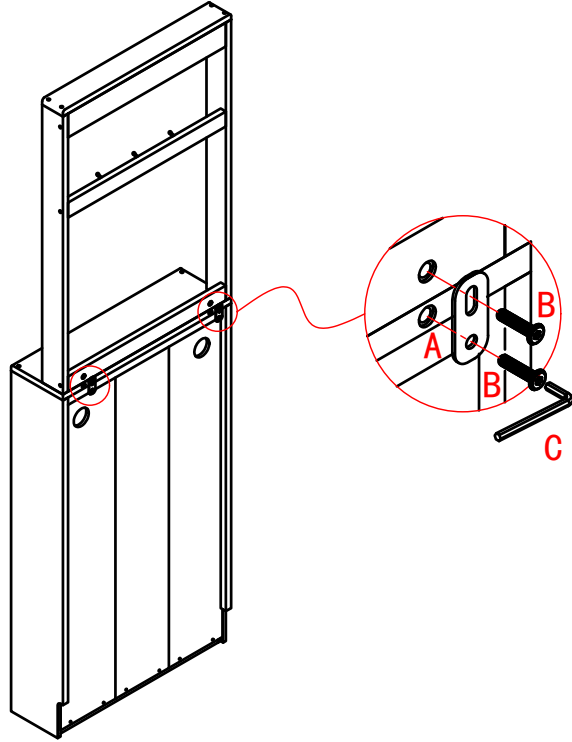

②安装L型防倒件，注意膨胀管螺丝一侧固定墙上，用 $\phi 6$ 钻头打孔。自备工具十字螺丝刀

