

LINSY 林氏家居

五金表/Hardware list

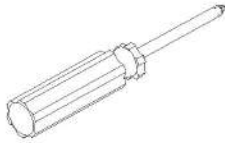

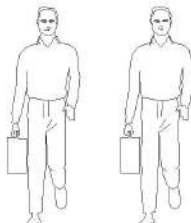





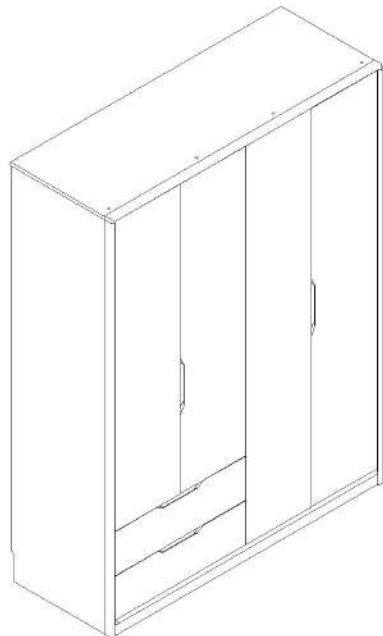

部件表/Parts List

安装示意图/Assembly Instruction

产品名称 Model NO.	UB1D-A
产品规格 Specification	1572*594*2111mm
安装工具 Tool	安装人数 Installer
	

注：为保证设计效果，部分尺寸为定制尺寸，不影响使用。

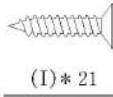
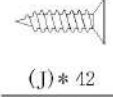
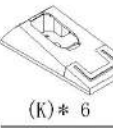
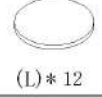

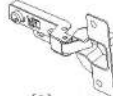
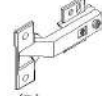
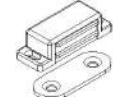
 (A)* 1 挂衣杆1 L=758mm Clothes hanging rod	 (B)* 2 挂衣杆2 L=356mm Clothes hanging rod	 (C)* 93 二合一螺钉 2-in-1-screw	 (D)* 93 大三合一锁饼 Three-in-one large lock
 (E)* 32 木榫08x30mm wood tenon	 (F)* 20 层板托5mm shelf support	 (G)* 2 过山丝-M7x38mm Self-tapping screw galvanized	 (H)* 13 背板扣 Back Plate Buckle-White
 (I)* 21 自攻螺丝M3.5x16mm Self-tapping screw	 (J)* 42 自攻螺丝M3.5x12mm Self-tapping screw	 (K)* 6 挂衣托 Clothes hanger	 (L)* 12 脚垫-灰色 Footrest - Grey
 (M)* 4 透气孔盖-白色 Vent cover - white	 (N)* 2 三节滚珠导轨-14" three-section ball rail	 (O)* 10 缓冲门铰大弯-杯径035 Hinge big hands diameter 35	 (P)* 4 缓冲门铰直弯-杯径035 Hinge straight bending diameter 35
 (Q)* 2 单层磁碰 magnetic catch-white			

编号NO.	名称Name	规格(mm) Specification	数量QTY	材质Material
柜体: Cabinet body				
①	顶板Top board	1572*544*18	1	刨花板 Particle Board
②	装饰条Decorative strip	1572*50*20	1	橡胶木 Rubber wood
③	底板Bottom board	1530*529*18	1	刨花板 Particle Board
④	前拉条Front brace	1530*50*18	1	橡胶木 Rubber wood
⑤	前后立水Front and back apron	1530*58*18	2	刨花板 Particle Board
⑥	中立水Middle apron	531*58*18	1	刨花板 Particle Board
⑦	左侧板Side board(L)	2088*544*18	1	刨花板 Particle Board
⑧	右侧板Side board(R)	2088*544*18	1	刨花板 Particle Board
⑨	左侧柱L side pillar	2088*50*20	1	橡胶木 Rubber wood
⑩	右侧柱Side column(R)	2088*50*20	1	橡胶木 Rubber wood
⑪	左中侧板Middle side board(L)	2012*526*18	1	刨花板 Particle Board
⑫	右中侧板Middle side board(R)	1624*504*18	1	刨花板 Particle Board
⑬	边背拉条Side back brace	2012*101*18	2	刨花板 Particle Board
⑭	背拉条Back brace	2012*201*18	1	刨花板 Particle Board
⑮	背板Back board	2022*575*5	2	纤维板 Fiberboard
⑯	左活动层板Movable shelf(L)	765*524*18	2	刨花板 Particle Board
⑰	右活动层板Movable shelf(R)	745*524*18	1	刨花板 Particle Board
⑱	小层板Small shelf	363*504*18	2	刨花板 Particle Board
⑲	大抽屉侧板Large drawer side panel	395*142*18	4	刨花板 Particle Board
⑳	大抽屉后板Big drawer's back board	740*142*18	2	刨花板 Particle Board
㉑	大抽屉底板Large drawer bottom plate	714*405*5	2	纤维板 Fiberboard
㉒	抽屉底托条Drawer's bottom bracket	395*58*18	2	刨花板 Particle Board
UB1D-A两门衣柜门板:UB1D-A two door wardrobe door panel				
①	左门板Door board(L)	2008*380*18	1	纤维板 Fiberboard
②	右门板Door board(R)	2008*380*18	1	纤维板 Fiberboard
UB1D-A两门衣柜带抽门板:UB1D-A two door wardrobe with sliding door panel				
①	左门板Door board(L)	1560*380*18	1	纤维板 Fiberboard

部件表/Parts List

编号NO.	名称Name	规格(mm) Specification	数量QTY	材质Material
②	右门板Door board(R)	1560*380*18	1	纤维板 Fiberboard
③	抽屉面板Drawer's top panel	762*222*18	2	纤维板 Fiberboard

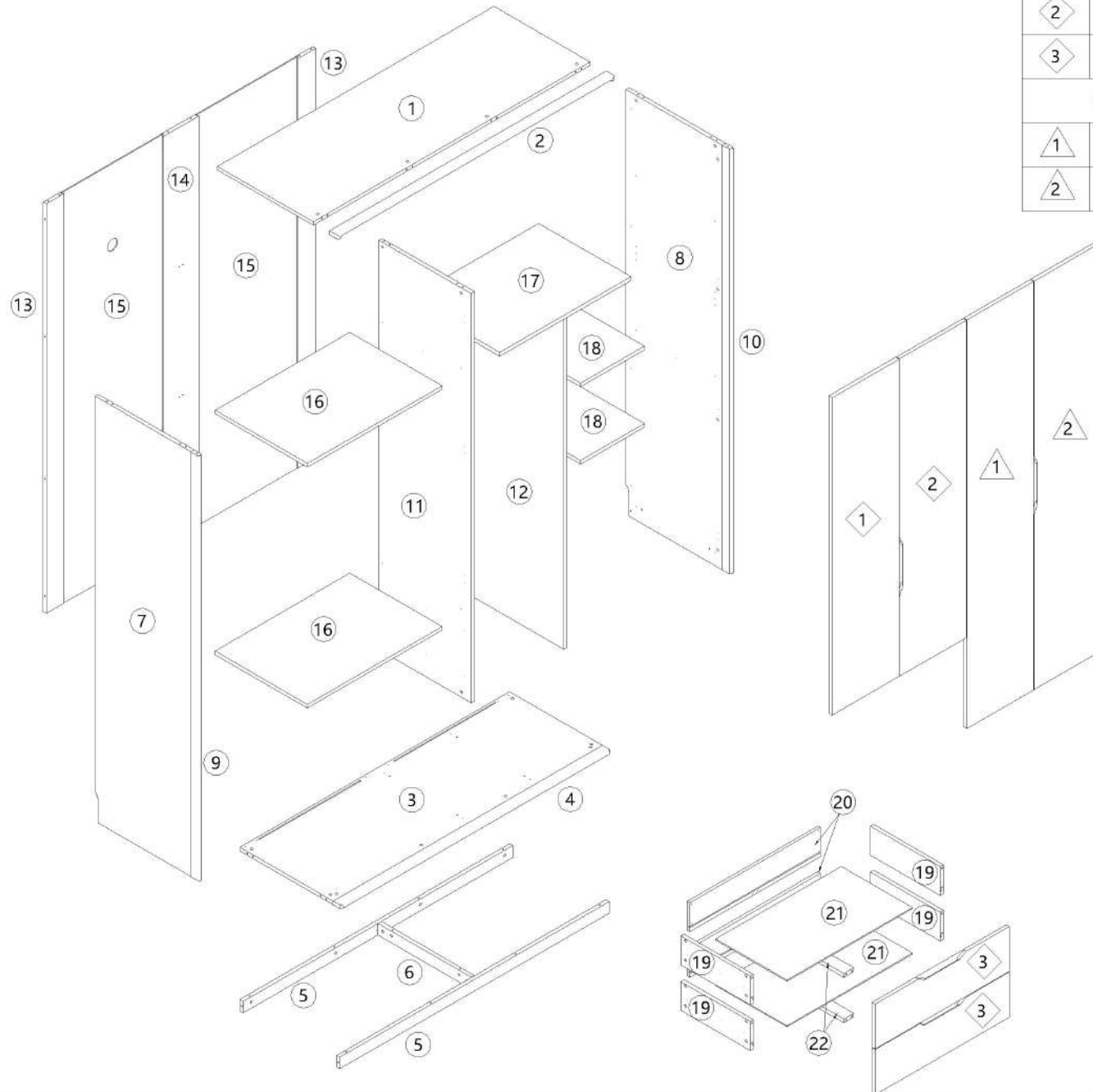

编号NO.	名称Name	编号NO.	名称Name
②	右门板Door board(R)	柜体	
③	抽屉面板Drawer's top panel	①	顶板Top board
UB1D-A两门衣柜门板		②	装饰条Decorative strip
①	左门板Door board(L)	③	底板Bottom board
②	右门板Door board(R)	④	前拉条Front brace
		⑤	前后立水Front and back apron
		⑥	中立水Middle apron
		⑦	左侧板Side board(L)
		⑧	右侧板Side board(R)
		⑨	左侧柱L side pillar
		⑩	右侧柱Side column(R)
		⑪	左中侧板Middle side board(L)
		⑫	右中侧板Middle side board(R)
		⑬	边背拉条Side back brace
		⑭	背拉条Back brace
		⑮	背板Back board
		⑯	左活动层板Movable shelf(L)
		⑰	右活动层板Movable shelf(R)
		⑱	小层板Small shelf
		⑲	大抽屉侧板Large drawer side panel
		⑳	大抽屉后板Big drawer's back board
		㉑	大抽屉底板Large drawer bottom plate
		㉒	抽屉底托条Drawer's bottom bracket
UB1D-A两门衣柜带抽门板			
①	左门板Door board(L)		

UB1D-A

安装方法/
Installation method

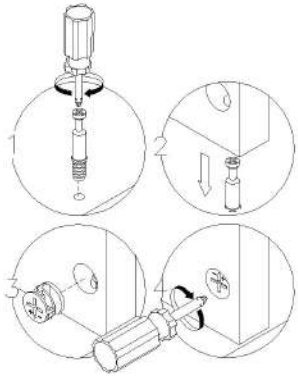

二合一 two-in-one

阀门开关(下压为开)
Valve switch (press down to open)

前 Forward 后 Back



主轨 Main track



副轨 Sub track

三节滚珠导轨
Three-section rail

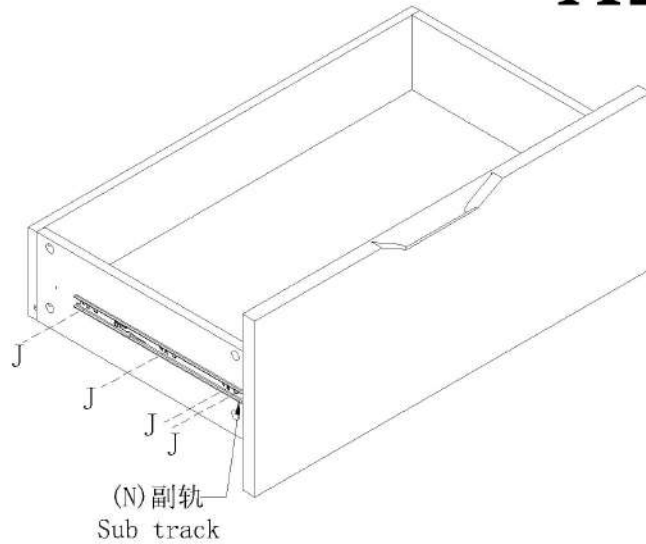

- (C)*12
- (D)*12

X2

1

- (C)*12
- (D)*12

X2

2

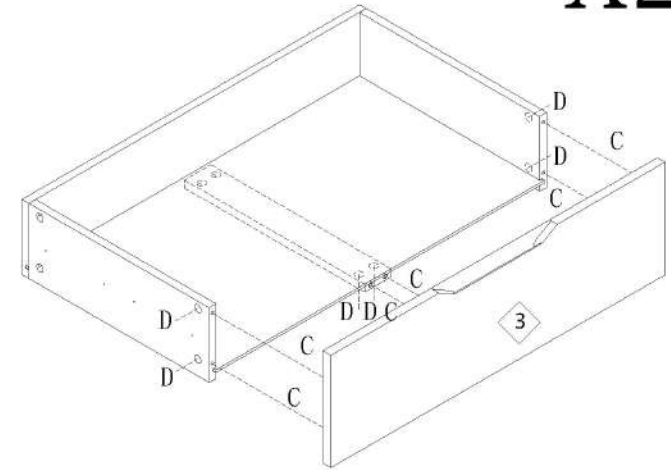

- (J)*16
- (N)*2

X2

3

- (C)*8
- (D)*8

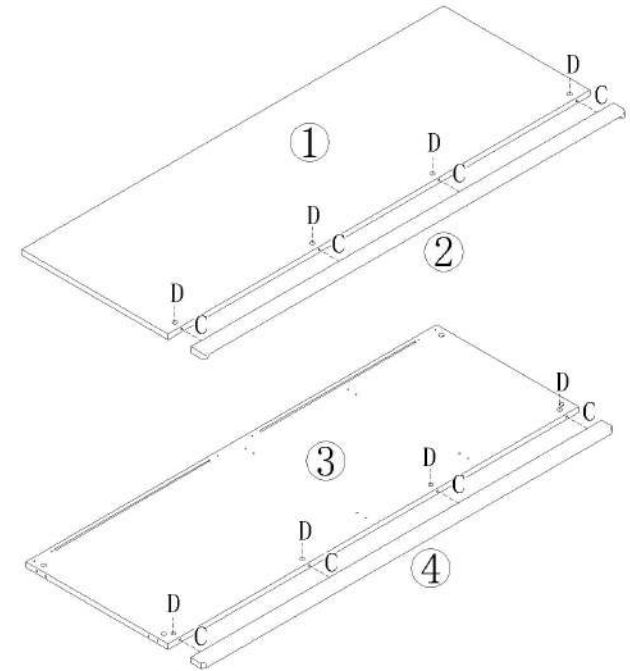

4

UB1D-A

安装方法/
Installation method

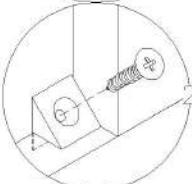
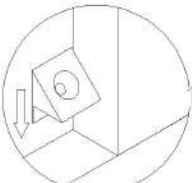
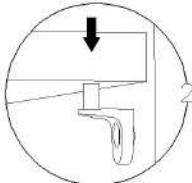

- (C)*12
- (D)*12
- (E)*8
- (L)*4

- (C)*2
- (D)*2
- (E)*2
- (F)*20

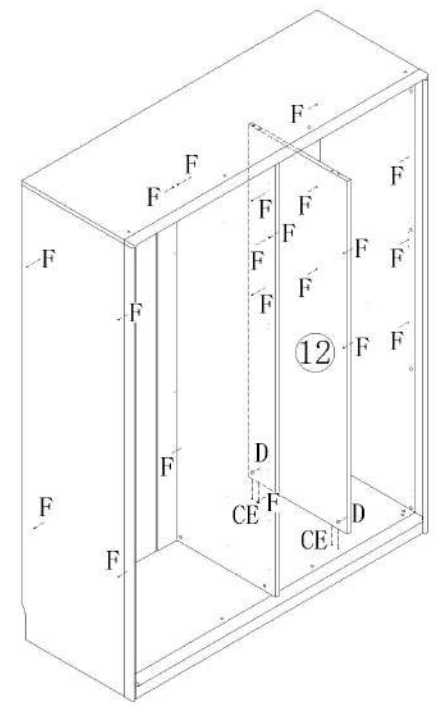
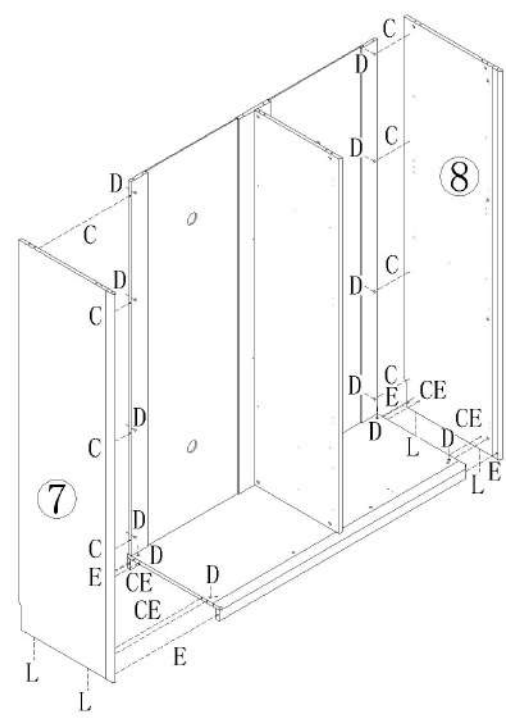

9

- (C)*12
- (D)*12
- (E)*8

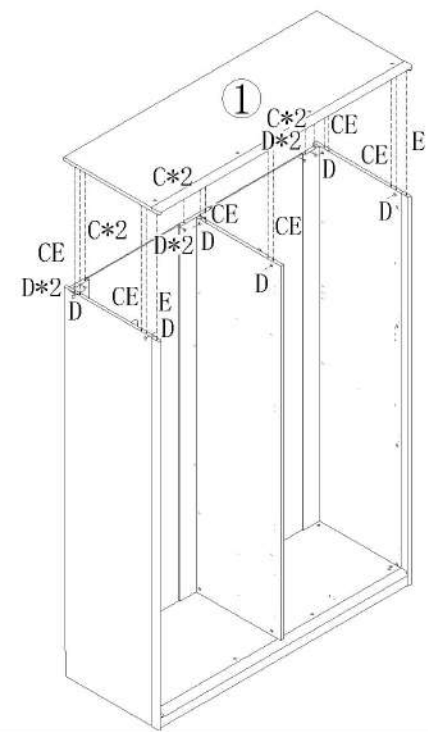

11

- (C)*2
- (D)*2
- (E)*2

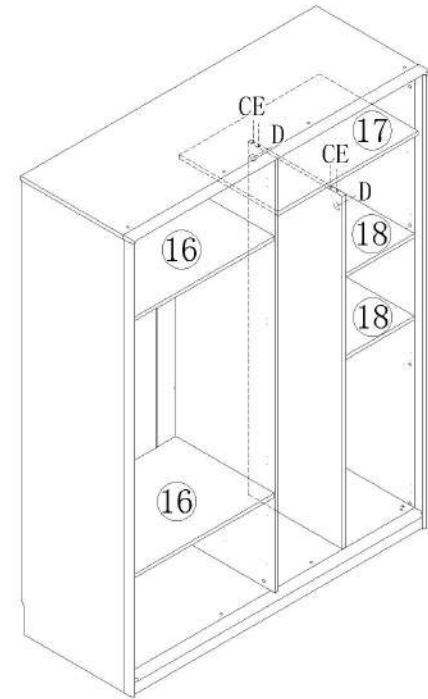

10

12

UB1D-A

安装方法/
Installation method

大弯big bend
中弯middle bending
直弯straight bending

侧板 side board
门板 Door panel

调节上下 Adjust up and down
调节左右 Adjust left and right
调节前后 Before and after adjustment

门铰 Hinge

- (A)*1
- (B)*2
- (J)*24
- (K)*6
- (N)*2
- (O)*10
- (I)*4
- (Q)*1

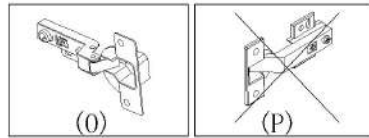
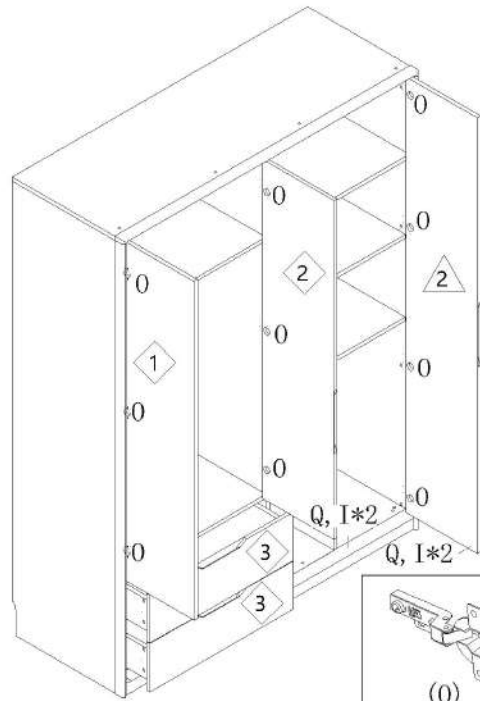
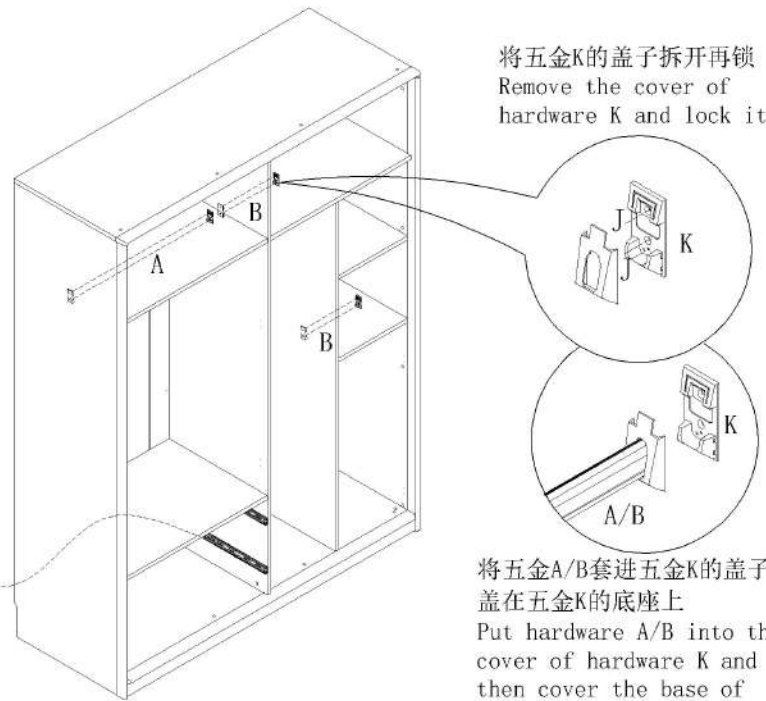
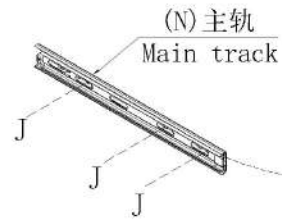

- (P)*4
- (H)*12
- (I)*16
- (Q)*1

