











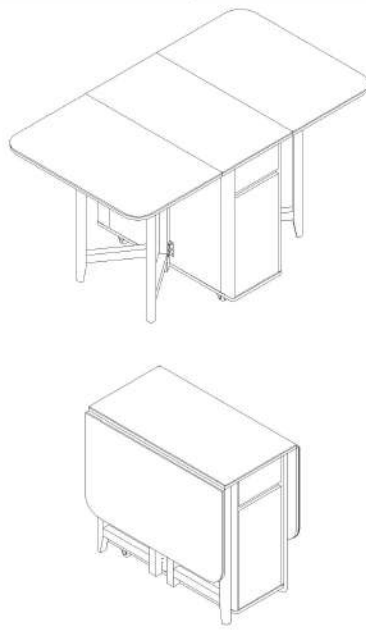









LINSY 林氏家居

安装示意图/Assembly Instruction

产品名称 Model NO.	UM2R-A(玻璃)
产品规格 Specification	1400*800*747mm
安装工具 Tool	安装人数 Installer
	



五金表/Hardware list

 (A)* 10 过山钉-M7x38mm Self-tapping screw galvanized	 (B)* 13 自攻螺丝M3.5x12mm Self-tapping screw	 (C)* 4 调节五金脚-M8x30 Adjusting foot	 (D)* 4 插销 Spring latch
 (E)* 2 缓冲门铰大号-Ø35 Hinge-big bends	 (F)* 34 二合一螺杆 2-in-1-screw	 (G)* 34 大三合一锁饼 Three-in-one large lock	 (H)* 42 木榫Ø6x30mm wood tenon
 (I)* 4 塑料螺母 Plastic Nut	 (J)* 4 小二合一杆 small two-in-one rod	 (K)* 4 小三合一锁饼 small three-in-one lock	 (L)* 8 半圆合页 Semicircular hinge
 (M)* 8 合页 Hinge	 (N)* 4 自攻螺丝M4x40mm Self-tapping screw	 (O)* 1 内六角扳手4mm In-hex spanner 4mm	 (P)* 4 脚垫-灰色 Footrest - Grey
 (Q)* 4 透明防撞垫片 anti-collision gasket	 (R)* 122 自攻螺丝M3.5x14mm Self-tapping screw	 (S)* 4 万向轮 Universal wheel	 (T)* 4 活动层板托 Movable shelf support
 (U)* 2 反弹器 Buffer	 (V)* 17 自攻大扁M4*16mm Self tapping flat screw	 (W)* 1 二节滚珠导轨-10° two-section ball rail	

部件表/Parts List

编号NO.	名称Name	规格 (mm) Specification	数量 QTY	材质Material
①	边面板组立 Side panel	800*493*20	2	人造板+玻璃 WBP+Glass
②	面板组立 Top panel	800*414*20	1	人造板+玻璃 WBP+Glass
③	装饰板1 Decoration board 1	654*70*15	1	实木Wood
④	装饰板2 Decoration board 2	654*70*15	1	实木Wood
⑤	装饰板3 Decoration board 3	654*70*15	1	实木Wood
⑥	装饰板4 Decoration board 4	654*70*15	1	实木Wood
⑦	侧板 Side board	654*654*15	2	人造板WBP
⑧	拉条 Brace	258*58*15	1	人造板WBP
⑨	背板 Back board	654*258*15	1	人造板WBP
⑩	底板 Bottom board	796*290*15	1	人造板WBP
⑪	左脚框 Foot frame(L)	711*350*35	2	实木Wood
⑫	门板 Door board	499*254*15	1	人造板WBP
⑬	抽屉面板 Drawer's top panel	254*126*15	1	人造板WBP
⑭	抽屉右侧板 Drawer's side board(R)	295*78*12	1	人造板WBP
⑮	抽屉左侧板 Drawer's side board(L)	295*78*12	1	人造板WBP
⑯	抽屉后板 Drawer's Back board	208*78*12	1	人造板WBP
⑰	抽屉底板 Drawer's Bottom board	218*291*5	1	人造板WBP
⑱	右脚框 Foot frame(R)	711*350*35	2	实木Wood

UM2R-A(玻璃)

产品分解图/
exploded drawing

部件表/Parts List

编号NO.	名称Name
①	边面板组立 Side panel
②	面板组立 Top panel
③	装饰板1 Decoration board 1
④	装饰板2 Decoration board 2
⑤	装饰板3 Decoration board 3
⑥	装饰板4 Decoration board 4
⑦	侧板 Side board
⑧	拉条 Brace
⑨	背板 Back board
⑩	底板 Bottom board
⑪	左脚框 Foot frame(L)
⑫	门板 Door board
⑬	抽屉面板 Drawer's top panel
⑭	抽屉右侧板 Drawer's side board(R)
⑮	抽屉左侧板 Drawer's side board(L)
⑯	抽屉后板 Drawer's Back board
⑰	抽屉底板 Drawer's Bottom board
⑱	右脚框 Foot frame(R)

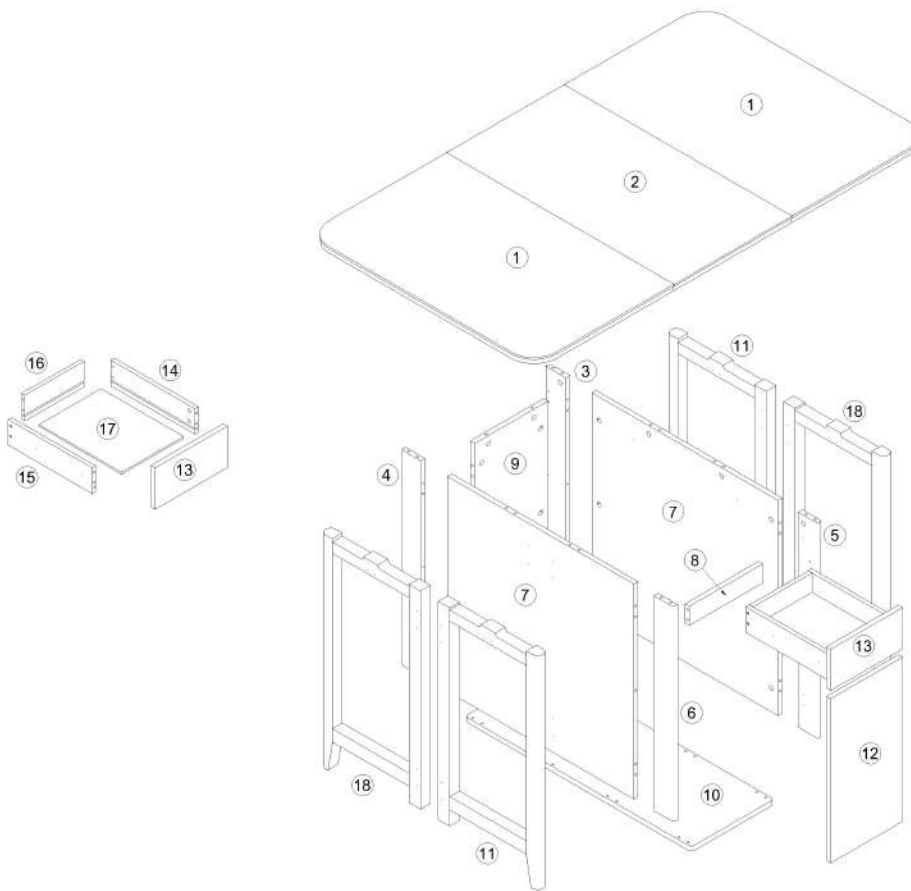

UM2R-A(玻璃)

安装方法/

Installation method

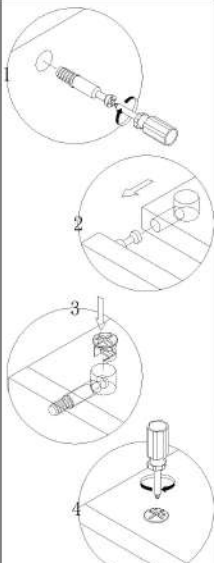

小二合一
small two-in-one

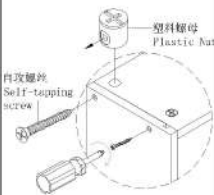

塑料螺母
Plastic Nut

- (J)*4
- (K)*4

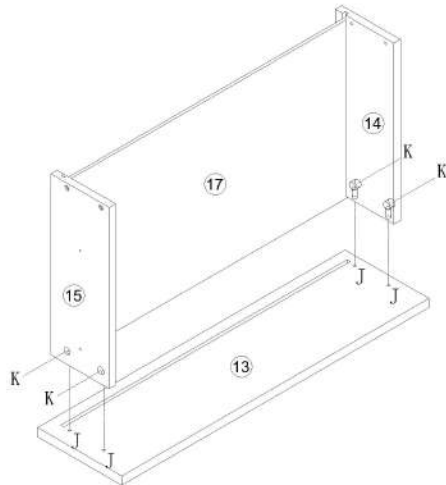

1

- (I)*4
- (B)*6
- (N)*4
- (W)*1

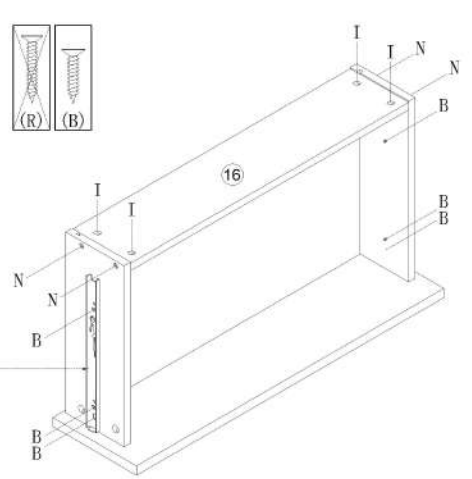
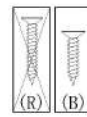

2

- (L)*8 (T)*4
- (Q)*4 (U)*1
- (R)*50

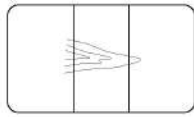

配套花色安装
Matching decor installation

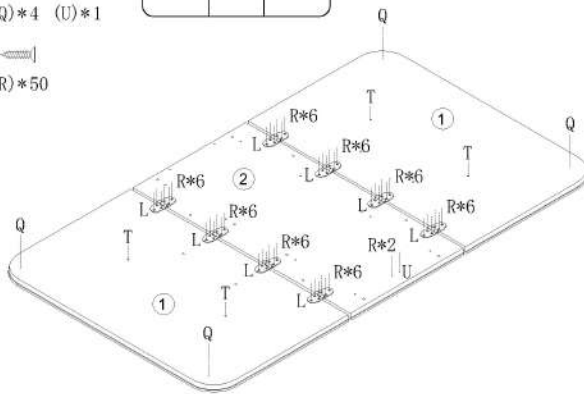

3

- (C)*4
- (D)*4
- (M)*8
- (P)*4
- (R)*40

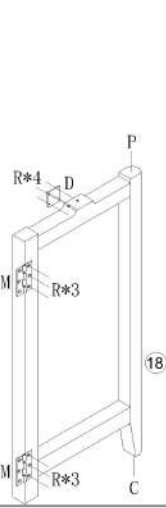

4

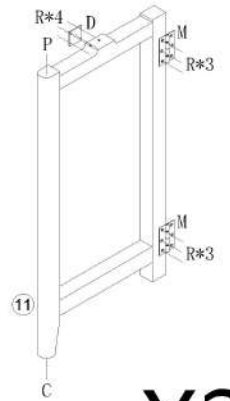

X2

UM2R-A(玻璃)

安装方法/

Installation method

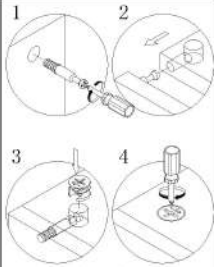

大二合一
two-in-one

大弯big bend

中弯middle bending

直弯straight bending

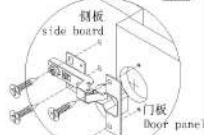

调节上下
Adjust up and down

调节左右
Adjust left and right

调节前后
Before and after adjustment
门铰
Hinge

- (F)*12
- (G)*12
- (H)*16

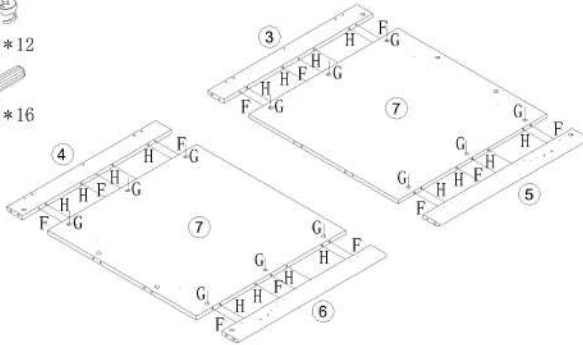

- (F)*10
- (G)*10
- (H)*8

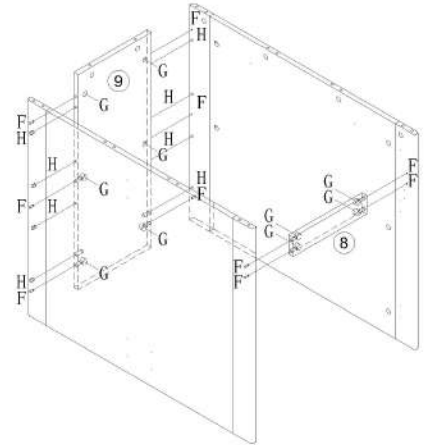

- (F)*10
- (G)*10
- (H)*8

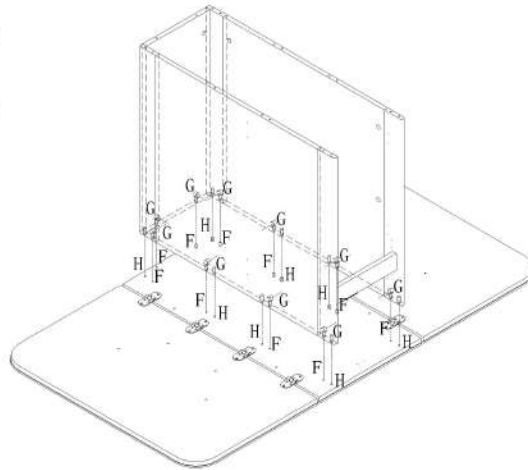

- (A)*8
- (H)*8
- (O)*1
- (V)*16
- (S)*4

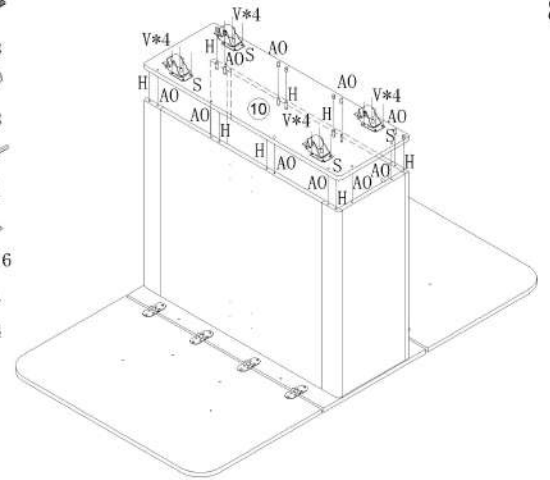

5

6

4/6

UM2R-A(玻璃)

安装方法/

Installation method

阀门开关(下压为开)
Valve switch
(press down to open)

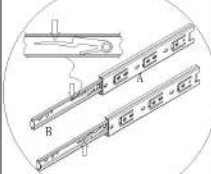

注: 先将A与B拆下来
Note: remove a and B first

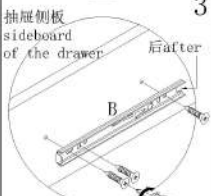
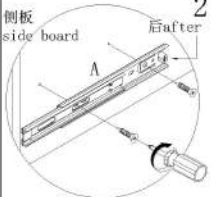

注: 将B对准A后推进去
Note: align B with a
and push it in
三节滚珠导轨
three-section ball rail

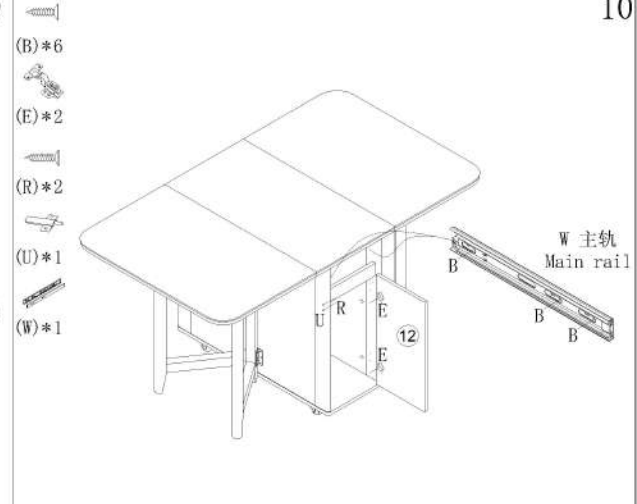
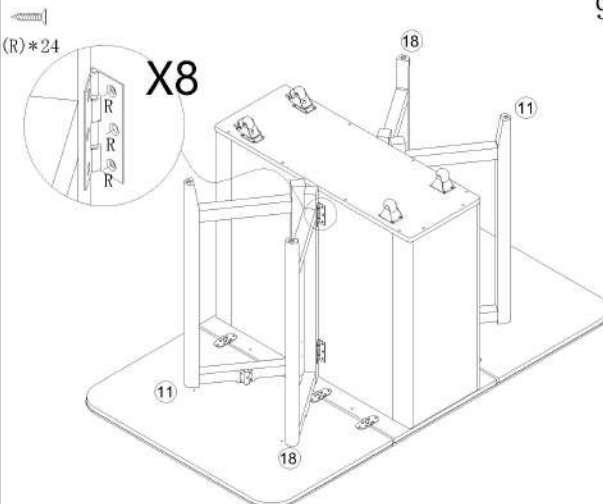

下推, 松开插销
Push down and
release the pin

UM2R-A(玻璃)

13

14

安装方法/
Installation method

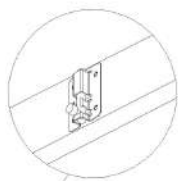

上推插销, 固定
Push up the latch to fix it

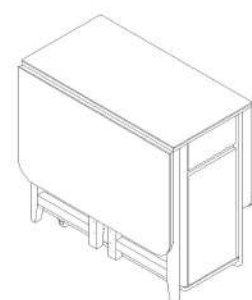

15

16