

PRODUCT DATA SHEET



PART NUMBER – B3TF3110-0AK6: BRAH Electric, aftermarket direct replacement contactors for Siemens 3TF3110-0AK6, World Series, type 3TF, 3P, 3PH, 12A, 600V, 3HP @ 230V, 7.5HP @ 460V, 10HP @ 575V, complete with 110/120V AC coil, 1 N/O auxiliary contact, AC magnetic contactor, suitable for use with 3TF series motor control systems

PRODUCT SPECIFICATIONS

MAGNETIC CONTACTOR
PART NO. B3TF3110-0AK6

**Voltage Selection Chart
B3TF31XXXX**

B3TF31	110/120V AC
B3TF3110	110/120V AC
B3TF3110-0AC2	24V AC
B3TF3110-0AK6	110/120V AC
B3TF3110-0AP6	240V AC
B3TF3110-0AV0	480V AC

<i>TYPE</i>	<i>VALUE (UNITS)</i>	<i>NOTES</i>	<i>COMMENTS</i>
<i>PHASE</i>	3		
<i>POLES</i>	3		
<i>VOLTAGE</i>	600 (VAC)		
<i>AMPERAGE</i>	12 (A)		
<i>COIL VOLTAGE MIN</i>	110 (V)		
<i>COIL VOLTAGE MAX</i>	120 (V)		
<i>MIN HP. RATING</i>	3 (HP)	@ 230V	
<i>MAX HP RATING</i>	10 (HP)	@ 575V	

Warranty: All Products sold by BRAH Electric are guaranteed to be free of defect for a period of one year, under the condition that the product has been installed and operated properly. All items proven defective within the one year period will be replaced by BRAH Electric. In the event that we cannot provide a direct replacement, your monies will be refunded in full. We are not responsible for any consequential losses or damages outside of the defective product as well as any replacements or repairs performed by another party without our written authorization from BRAH Electric.

REVISIONS				
ZONE	REV.	DESCRIPTION	DATE	APPROVED

MOUNTING HOLES

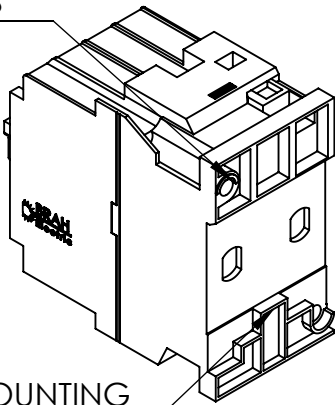

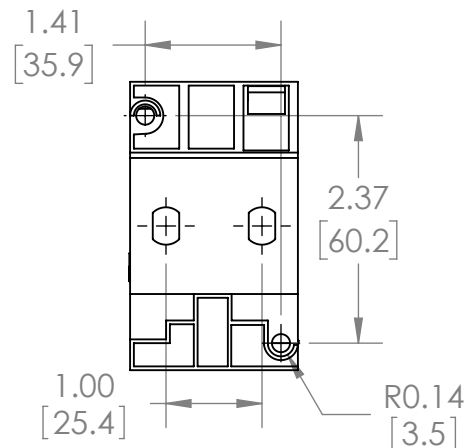
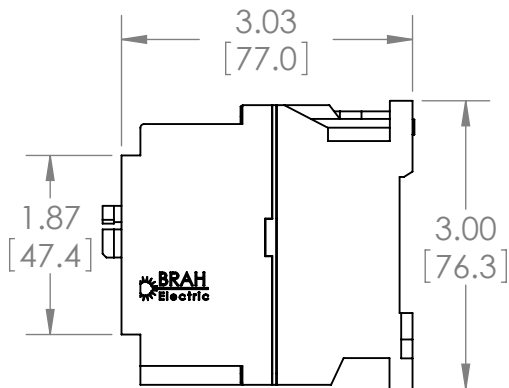
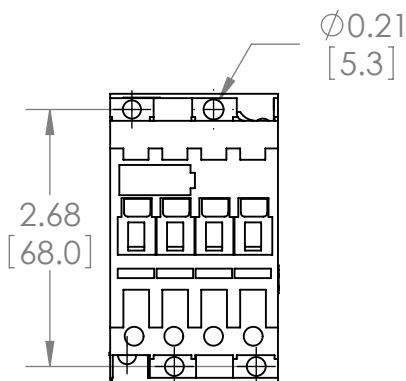
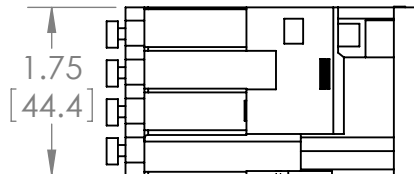
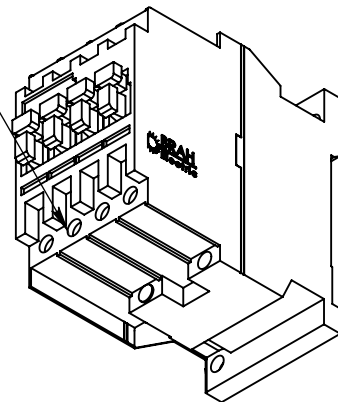

MOUNTING FEATURES

LOAD SIDE WIRE TERMINALS

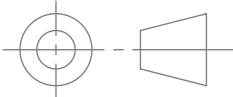

WWW.BRAHELECTRIC.COM, 855-355-2724

*NOTE: BRAH ELECTRIC CONTACTOR B3TF3110-0AK6 IS AN AFTERMARKET DIRECT REPLACEMENT FOR 3TF3110-0AK6, 3TF SERIES, SUITABLE FOR USE WITH 3TF SERIES MOTOR CONTROL SYSTEMS

 THIRD ANGLE PROJECTION	UNLESS OTHERWISE NOTED ALL DIMENSIONS ARE IN INCHES METRIC UNITS ARE DISPLAYED BENEATH IN [MM.]	 BRAH Electric
	PROPRIETARY AND CONFIDENTIAL THE INFORMATION CONTAINED IN THIS DRAWING IS THE SOLE PROPERTY OF BRAH ELECTRIC. ANY REPRODUCTION IN PART OR AS A WHOLE WITHOUT THE WRITTEN PERMISSION OF BRAH ELECTRIC IS PROHIBITED.	
DO NOT SCALE DRAWING	SIZE A DWG. NO. B3TF3110-0AK6	REV. A
SCALE: 1:2	WEIGHT: 3.2 LBS	SHEET 1 OF 1