

PRODUCT DATA SHEET



PART NUMBER – B3TF3110-0AV0: BRAH Electric, aftermarket direct replacement contactors for Siemens 3TF3110-0AV0, World Series, type 3TF, 3P, 3PH, 12A, 600V, 3HP @ 230V, 7.5HP @ 460V, 10HP @ 575V, complete with 480V AC coil, 1 N/O auxiliary contact, AC magnetic contactor, suitable for use with 3TF series motor control systems

PRODUCT SPECIFICATIONS

MAGNETIC CONTACTOR
PART NO. B3TF3110-0AV0

**Voltage Selection Chart
B3TF31XXXX**

| | |
|---------------|-------------|
| B3TF31 | 110/120V AC |
| B3TF3110 | 110/120V AC |
| B3TF3110-0AC2 | 24V AC |
| B3TF3110-0AK6 | 110/120V AC |
| B3TF3110-0AP6 | 240V AC |
| B3TF3110-0AV0 | 480V AC |

| TYPE | VALUE (UNITS) | NOTES | COMMENTS |
|------------------|---------------|--------|----------|
| PHASE | 3 | | |
| POLES | 3 | | |
| VOLTAGE | 600 (VAC) | | |
| AMPERAGE | 12 (A) | | |
| COIL VOLTAGE MIN | 480 (V) | | |
| COIL VOLTAGE MAX | 480 (V) | | |
| MIN HP. RATING | 3 (HP) | @ 230V | |
| MAX HP RATING | 10 (HP) | @ 575V | |

Warranty: All Products sold by BRAH Electric are guaranteed to be free of defect for a period of one year, under the condition that the product has been installed and operated properly. All items proven defective within the one year period will be replaced by BRAH Electric. In the event that we cannot provide a direct replacement, your monies will be refunded in full. We are not responsible for any consequential losses or damages outside of the defective product as well as any replacements or repairs performed by another party without our written authorization from BRAH Electric.

| REVISIONS | | | | |
|-----------|------|-------------|------|----------|
| ZONE | REV. | DESCRIPTION | DATE | APPROVED |

MOUNTING HOLES

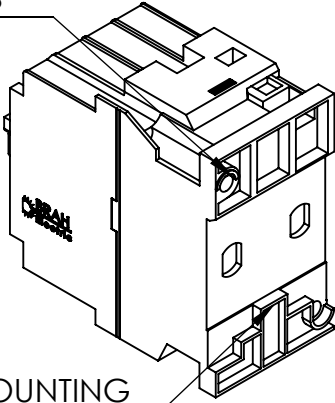

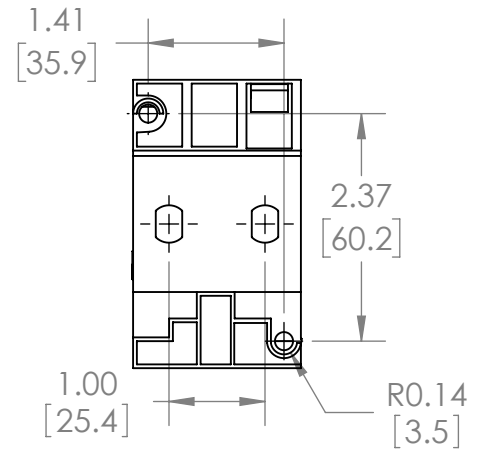
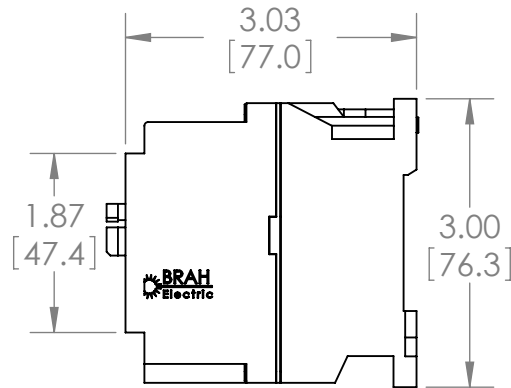
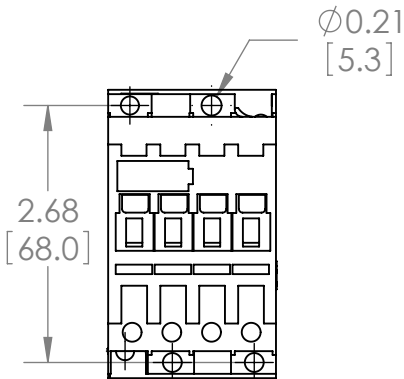
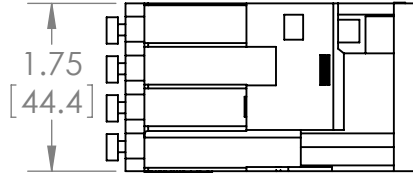
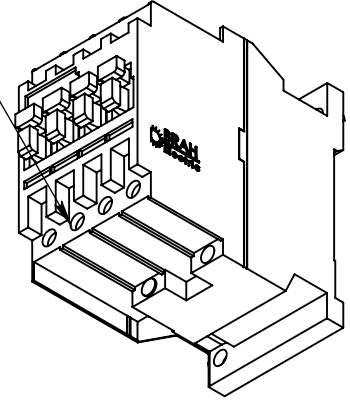

MOUNTING FEATURES

LOAD SIDE WIRE TERMINALS

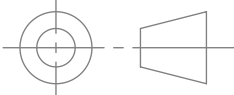

WWW.BRAHELECTRIC.COM, 855-355-2724

*NOTE: BRAH ELECTRIC CONTACTOR B3TF31 10-0AV0 IS AN AFTERMARKET DIRECT REPLACEMENT FOR 3TF31 10-0AV0, 3TF SERIES. SUITABLE FOR USE WITH 3TF SERIES MOTOR CONTROL SYSTEMS

| | | |
|---|---|--|
|  THIRD ANGLE PROJECTION | UNLESS OTHERWISE NOTED ALL DIMENSIONS ARE IN INCHES METRIC UNITS ARE DISPLAYED BENEATH IN [MM.] |  BRAH Electric |
| | PROPRIETARY AND CONFIDENTIAL THE INFORMATION CONTAINED IN THIS DRAWING IS THE SOLE PROPERTY OF BRAH ELECTRIC. ANY REPRODUCTION IN PART OR AS A WHOLE WITHOUT THE WRITTEN PERMISSION OF BRAH ELECTRIC IS PROHIBITED. | |
| DO NOT SCALE DRAWING | SIZE A DWG. NO. B3TF31 10-0AV0 | SCALE: 1:2 WEIGHT: 3.2 LBS SHEET 1 OF 1 |