

PRODUCT DATA SHEET

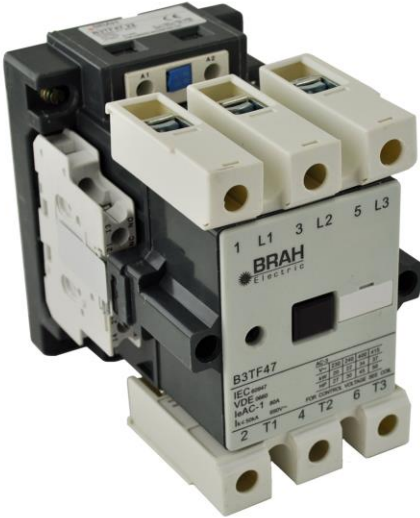

PART NUMBER – B3TF5022-0AC2: BRAH Electric, aftermarket direct replacement contactors for Siemens 3TF5022-0AC2, World Series, type 3TF, 3P, 3PH, 110A, 600V, 50HP @ 230V, 100HP @ 460V, 125HP @ 575V, complete with 24V AC coil, 2 N/O - 2 N/C auxiliary contact, AC magnetic contactor, suitable for use with 3TF series motor control systems.

PRODUCT SPECIFICATIONS

MAGNETIC CONTACTOR
PART NO. B3TF5022-0AC2

**Voltage Selection Chart
B3TF50XXXX**

B3TF50	110/120V AC
B3TF5022	110/120V AC
B3TF5022-0AC2	24V AC
B3TF5022-0AK6	110/120V AC
B3TF5022-0AP6	240V AC
B3TF5022-0AV0	480V AC

<i>TYPE</i>	<i>VALUE (UNITS)</i>	<i>NOTES</i>	<i>COMMENTS</i>
<i>PHASE</i>	3		
<i>POLES</i>	3		
<i>VOLTAGE</i>	600 (VAC)		
<i>AMPERAGE</i>	110 (A)		
<i>COIL VOLTAGE MIN</i>	24 (V)		
<i>COIL VOLTAGE MAX</i>	24 (V)		
<i>MIN HP. RATING</i>	50 (HP)	@ 230V	
<i>MAX HP RATING</i>	125 (HP)	@ 575V	

Warranty: All Products sold by BRAH Electric are guaranteed to be free of defect for a period of one year, under the condition that the product has been installed and operated properly. All items proven defective within the one year period will be replaced by BRAH Electric. In the event that we cannot provide a direct replacement, your monies will be refunded in full. We are not responsible for any consequential losses or damages outside of the defective product as well as any replacements or repairs performed by another party without our written authorization from BRAH Electric.

MOUNTING HOLES

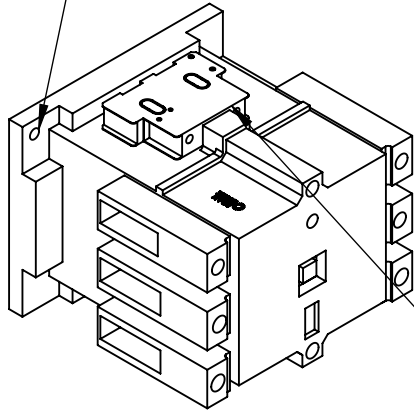

LATERALLY MOUNTED
AUXILIARY SWITCH BLOCK

REVISIONS				
ZONE	REV.	DESCRIPTION	DATE	APPROVED

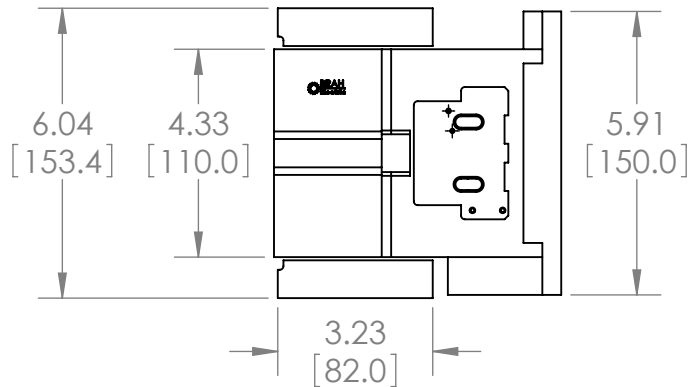
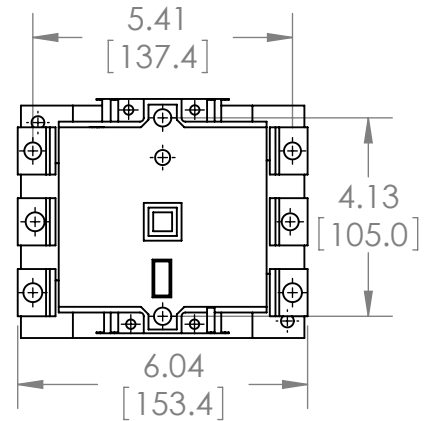
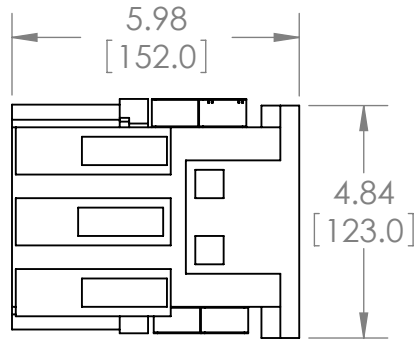
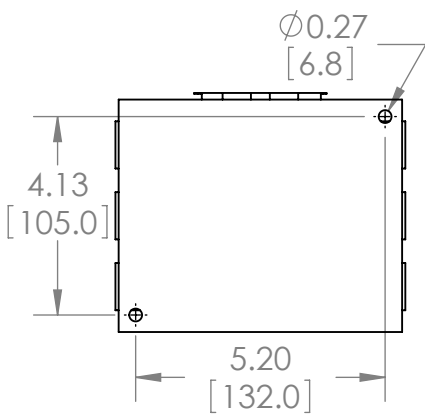

WWW.BRAHELECTRIC.COM, 855-355-2724

*NOTE: BRAH ELECTRIC CONTACTOR B3TF5022-0AC2 IS AN AFTERMARKET DIRECT REPLACEMENT FOR 3TF5022-0AC2, 3TF SERIES. SUITABLE FOR USE WITH 3TF SERIES MOTOR CONTROL SYSTEMS

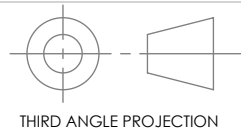

THIRD ANGLE PROJECTION

PROPRIETARY AND CONFIDENTIAL

THE INFORMATION CONTAINED IN THIS DRAWING IS THE SOLE PROPERTY OF BRAH ELECTRIC. ANY REPRODUCTION IN PART OR AS A WHOLE WITHOUT THE WRITTEN PERMISSION OF BRAH ELECTRIC IS PROHIBITED.

UNLESS OTHERWISE NOTED

ALL DIMENSIONS ARE IN INCHES
METRIC UNITS ARE DISPLAYED
BENEATH IN [MM.]

MATERIAL
MOLDED PLASTIC CASE

FINISH
N/A

DO NOT SCALE DRAWING



MAGNETIC CONTACTOR

SIZE A	DWG. NO. B3TF5022-0AC2	REV. A
SCALE: 1:4	WEIGHT: 3.2 LBS	SHEET 1 OF 1