



CONTACT US @ 855-355-2724

E-Mail: [Sales@brahelectric.com](mailto:Sales@brahelectric.com)

[www.Brahelectric.com](http://www.Brahelectric.com)

## PRODUCT DATA SHEET



**PART NUMBER – B3UA52-00-2A:** BRAH Electric, aftermarket direct replacement solid state overload relays for Siemens 3UA52-00-2A, World Series, type 3UA, rated for 10.00-16.00 amps, suitable for 3TF32, 3TF33, 3TF42, 3TF43, 3TB42, 3TB43 contactors

### PRODUCT SPECIFICATIONS

MOTOR STARTER OVERLOAD RELAY  
PART NO. B3UA52-00-2A

<i>TYPE</i>	<i>VALUE (UNITS)</i>	<i>NOTES</i>	<i>COMMENTS</i>
<i>PHASE</i>	3		
<i>POLES</i>	3		
<i>AMPERAGE MIN</i>	10.00 (A)		
<i>AMPERAGE MAX</i>	16.00(A)		
<i>VOLTAGE RATING</i>	600V AC		
<i>TRIP CURRENT</i>	125% OF DIAL SETTING		
<i>SUITABLE FOR USE WITH</i>	3TF32, 3TF33, 3TF42, 3TF43, 3TB42, 3TB43		
<i>RELAY STYLE</i>	SOLID STATE		

#### ADDITIONAL INFORMATION:

- \* Overload relays are configured with adjustable amperage range settings. Many of the models overlap in amperage range, make sure to verify the required range specification for your application.
- \* Auxiliary contacts are arranged with screw type terminals. Includes 1 NO & 1 NC auxiliary contact

#### WARRANTY:

All Products sold by BRAH Electric are guaranteed to be free of defect for a period of one year, under the condition that the product has been installed and operated properly. All items proven defective within the one year period will be replaced by BRAH Electric. In the event that we cannot provide a direct replacement, your monies will be refunded in full. We are not responsible for any consequential losses or damages outside of the defective product as well as any replacements or repairs performed by another party without our written authorization from BRAH Electric.

REVISIONS				
ZONE	REV.	DESCRIPTION	DATE	APPROVED

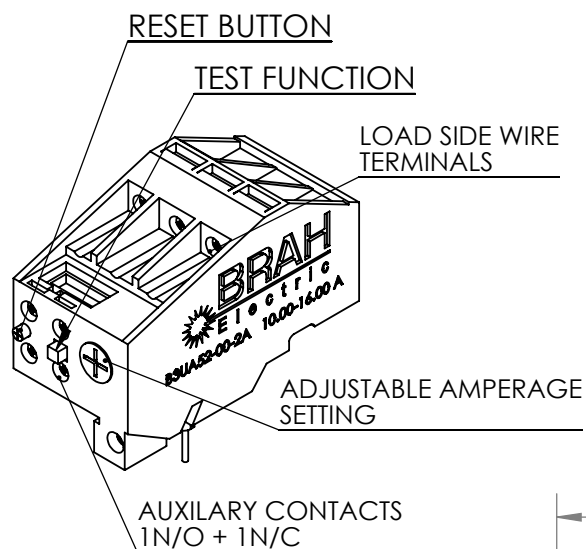

MOUNTING INTERFACE INTEGRATES WITH CONTACTOR

CONNECTION TERMINALS THAT MATE WITH CONTACTOR

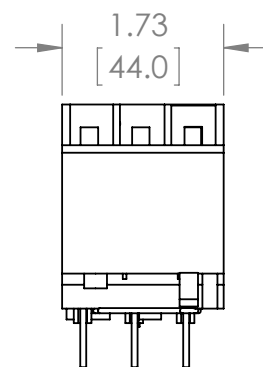
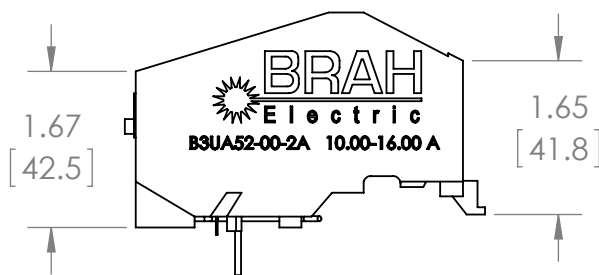
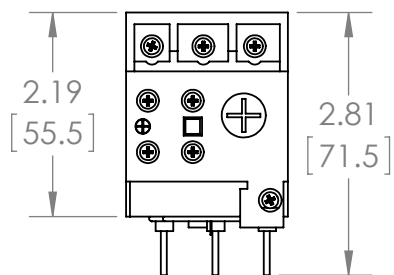
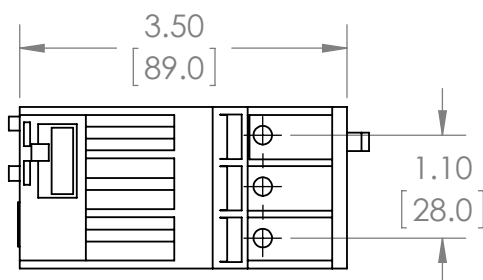
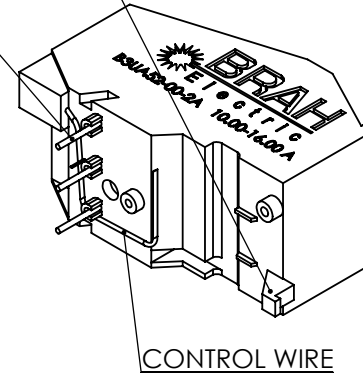

0.55 PTCH [14.0]

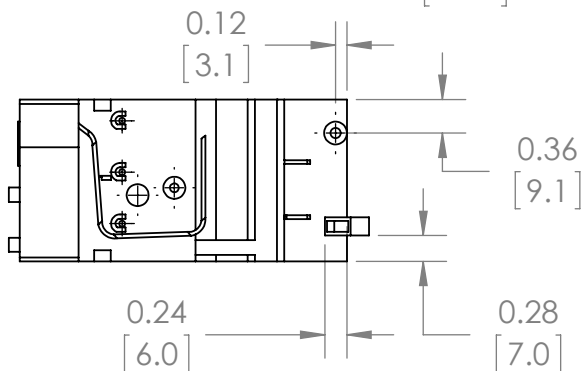

\*NOTE: THIS BRAH ELECTRIC OVERLOAD RELAY B3UA52-00-2A AN AFTERMARKET DIRECT REPLACEMENT FOR SIEMENS 3UA52-00-2A. SUITABLE FOR USE WITH 3UA MOTOR CONTROL SYSTEMS

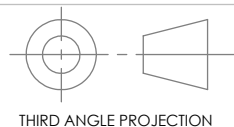

PROPRIETARY AND CONFIDENTIAL  
THE INFORMATION CONTAINED IN THIS DRAWING IS THE SOLE PROPERTY OF BRAH ELECTRIC. ANY REPRODUCTION IN PART OR AS A WHOLE WITHOUT THE WRITTEN PERMISSION OF BRAH ELECTRIC IS PROHIBITED.

UNLESS OTHERWISE NOTED  
ALL DIMENSIONS ARE IN INCHES  
METRIC UNITS ARE DISPLAYED  
BENEATH IN [ MM. ]

MATERIAL: MOLDED CASE  
FINISH: N/A  
DO NOT SCALE DRAWING



OVERLOAD RELAY

SIZE A	DWG. NO. B3UA52-00-2A	REV. A
SCALE: 1:2	WEIGHT: 3.2 LBS	SHEET 1 OF 1