

PRODUCT DATA SHEET



PART NUMBER – BA16-30-10-80: BRAH Electric, aftermarket direct replacement contactors for ABB A16-30-10-80, A-Line series, type A, 3P, 3PH, 17A, 600V, 5HP @ 240V, 10HP @ 480V, 15HP @ 600V, complete with 220/240V AC coil, and 1 N/O auxiliary contact, AC magnetic contactor, suitable for use with A-Line series motor control systems

PRODUCT SPECIFICATIONS

MAGNETIC CONTACTOR
PART NO. BA16-30-10-80

Voltage Selection Charts BA16-XXXX

BA16-30-10	120V AC
BA16-30-10-42	277V AC
BA16-30-10-51	480V AC
BA16-30-10-55	500/600V AC
BA16-30-10-80	240V AC
BA16-30-10-81	24V AC
BA16-30-10-83	48V AC
BA16-30-10-84	120V AC
BA16-30-10-86	415/440V AC

TYPE	VALUE (UNITS)	NOTES	COMMENTS
PHASE	3		
POLES	3		
VOLTAGE	600 (VAC)		
AMPERAGE	17 (A)		
COIL VOLTAGE MIN	220 (VAC)		
COIL VOLTAGE MAX	240 (VAC)		
MIN HP. RATING	5 (HP)	@ 240V	
MAX HP RATING	15 (HP)	@ 600V	

Warranty: All Products sold by BRAH Electric are guaranteed to be free of defect for a period of one year, under the condition that the product has been installed and operated properly. All items proven defective within the one year period will be replaced by BRAH Electric. In the event that we cannot provide a direct replacement, your monies will be refunded in full. We are not responsible for any consequential losses or damages outside of the defective product as well as any replacements or repairs performed by another party without our written authorization from BRAH Electric.

REVISIONS				
ZONE	REV.	DESCRIPTION	DATE	APPROVED

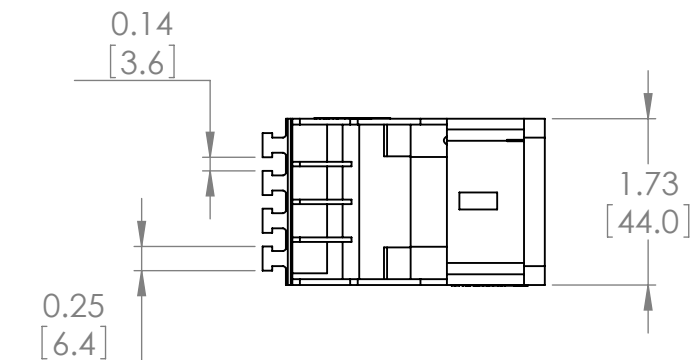
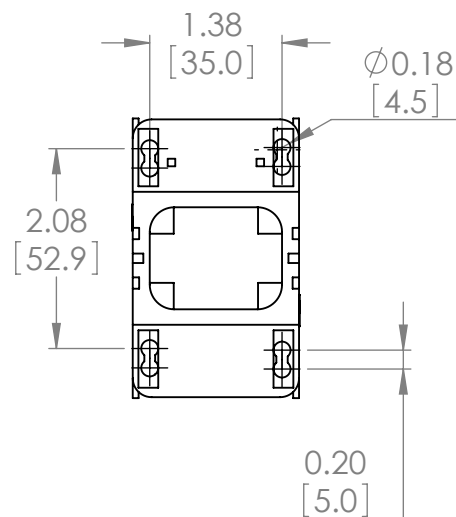
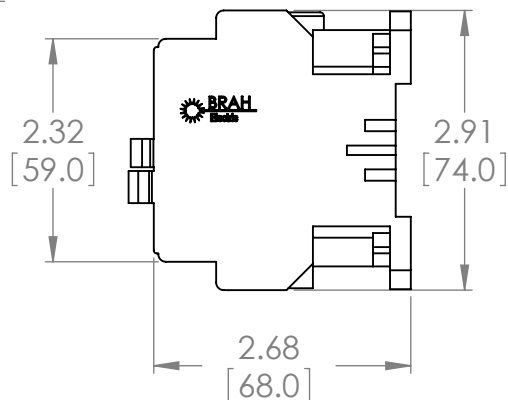
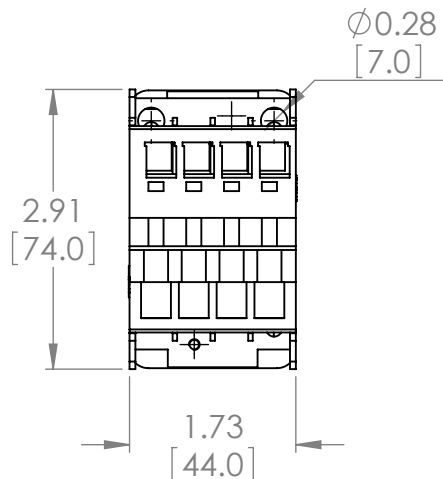
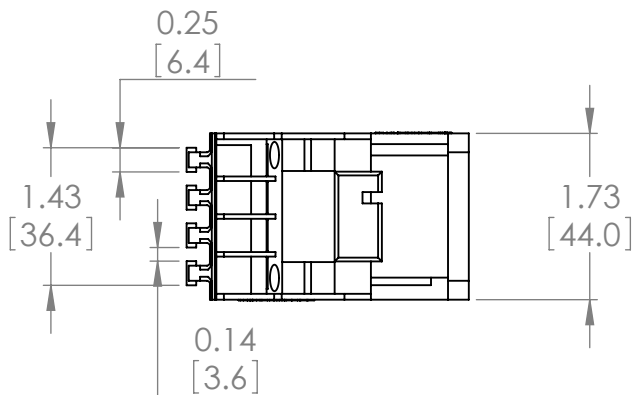
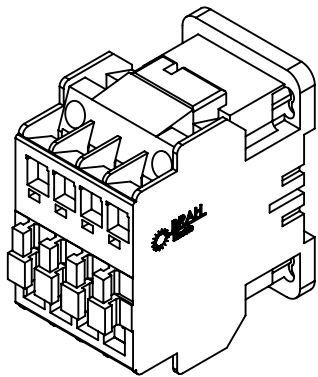

WWW.BRAHELECTRIC.COM, 855-355-2724

* NOTE: BRAH ELECTRIC CONTACTOR BA 16-30-10-80 IS AN AFTERMARKET DIRECT REPLACEMENT FOR ABB A16-30-10-80, A SERIES. SUITABLE FOR USE WITH A-SERIES MOTOR CONTROL SYSTEMS

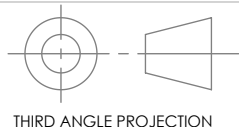

PROPRIETARY AND CONFIDENTIAL
THE INFORMATION CONTAINED IN THIS DRAWING IS THE SOLE PROPERTY OF BRAH ELECTRIC. ANY REPRODUCTION IN PART OR AS A WHOLE WITHOUT THE WRITTEN PERMISSION OF BRAH ELECTRIC IS PROHIBITED.

UNLESS OTHERWISE NOTED
ALL DIMENSIONS ARE IN INCHES
METRIC UNITS ARE DISPLAYED
BENEATH IN [MM.]

MATERIAL
MOLDED PLASTIC CASE
FINISH
N/A
DO NOT SCALE DRAWING



MAGNETIC CONTACTOR

SIZE A	DWG. NO. BA16-30-10-80	REV. A
SCALE: 1:2	WEIGHT: 3.2 LBS	SHEET 1 OF 1