

## PRODUCT DATA SHEET

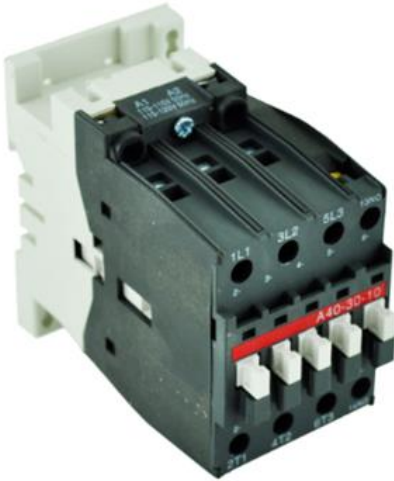

**PART NUMBER – BA40-30-10-51:** BRAH Electric, contactors, aftermarket direct replacement contactors for ABB A40-30-10-51, A-Line series, type A, 3P, 3PH, 42A, 600V, 15HP @ 240V, 30HP @ 480V, 40HP @ 600V, complete with 480V AC coil, and 1 N/O auxiliary contact, AC magnetic contactor, suitable for use with A-Line series motor control systems

### PRODUCT SPECIFICATIONS

MAGNETIC CONTACTOR  
PART NO. BA40-30-10-51

#### Voltage Selection Charts BA40-XXXX

BA40-30-10	120V AC
BA40-30-10-42	277V AC
BA40-30-10-51	480V AC
BA40-30-10-55	500/600V AC
BA40-30-10-80	220/240V AC
BA40-30-10-81	24V AC
BA40-30-10-83	48V AC
BA40-30-10-84	120V AC
BA40-30-10-86	415/440V AC

TYPE	VALUE (UNITS)	NOTES	COMMENTS
PHASE	3		
POLES	3		
VOLTAGE	600 (VAC)		
AMPERAGE	42 (A)		
COIL VOLTAGE MIN	480 (V)		
COIL VOLTAGE MAX	480 (V)		
MIN HP. RATING	15 (HP)	@ 240V	
MAX HP RATING	40 (HP)	@ 600V	

**Warranty:** All Products sold by BRAH Electric are guaranteed to be free of defect for a period of one year, under the condition that the product has been installed and operated properly. All items proven defective within the one year period will be replaced by BRAH Electric. In the event that we cannot provide a direct replacement, your monies will be refunded in full. We are not responsible for any consequential losses or damages outside of the defective product as well as any replacements or repairs performed by another party without our written authorization from BRAH Electric.

REVISIONS				
ZONE	REV.	DESCRIPTION	DATE	APPROVED

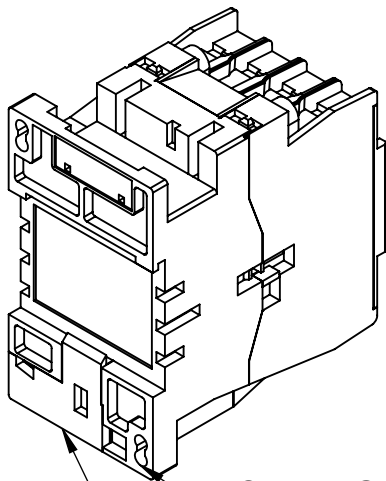

MOUNTING HOLES

MOUNTING FIXTURES

LOAD SIDE WIRE TERMINAL

LOCATION OF FUNCTION MARKER

STOPS FOR ATTACHING FRONT MOUNTED ACCESORIES

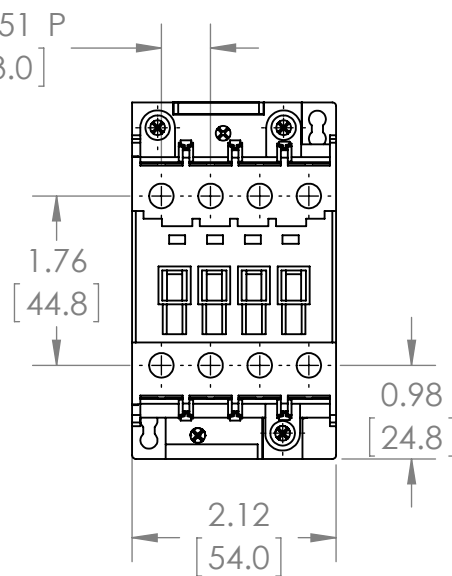
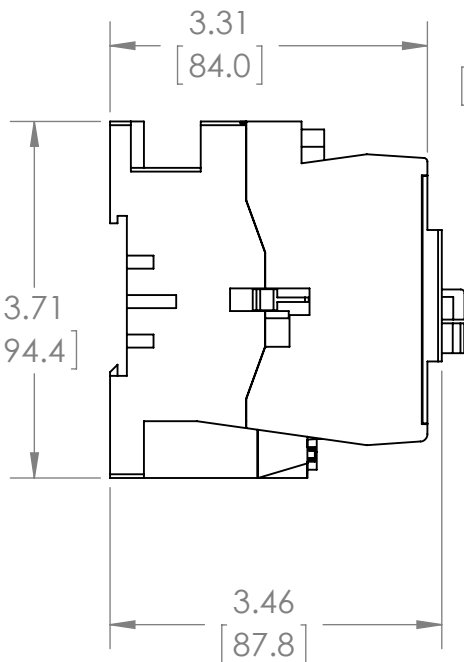
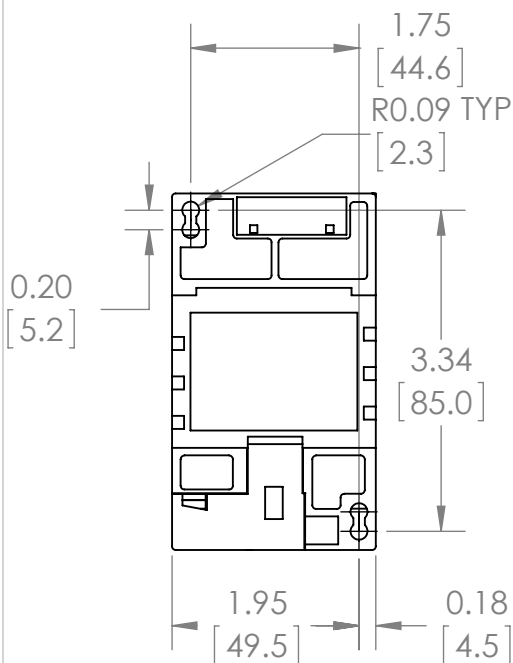
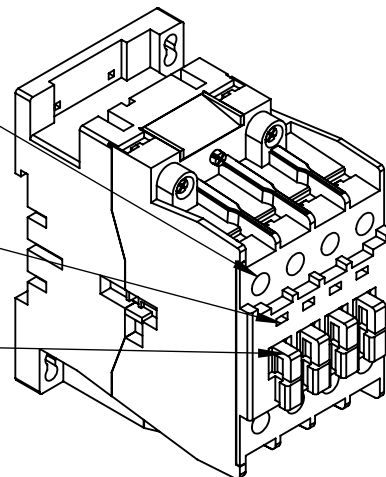

[WWW.BRAHELECTRIC.COM](http://WWW.BRAHELECTRIC.COM), 855-355-2724

\*NOTE: BRAH ELECTRIC CONTACTOR BA40-30-10-51 IS AN AFTERMARKET DIRECT REPLACEMENT FOR ABB A40-30-10-51, A-LINE SERIES. SUITABLE FOR USE WITH A-LINE SERIES MOTOR CONTROL SYSTEMS

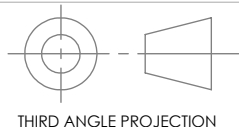

THIRD ANGLE PROJECTION

**PROPRIETARY AND CONFIDENTIAL**

THE INFORMATION CONTAINED IN THIS DRAWING IS THE SOLE PROPERTY OF BRAH ELECTRIC. ANY REPRODUCTION IN PART OR AS A WHOLE WITHOUT THE WRITTEN PERMISSION OF BRAH ELECTRIC IS PROHIBITED.

UNLESS OTHERWISE NOTED

ALL DIMENSIONS ARE IN INCHES  
METRIC UNITS ARE DISPLAYED  
BENEATH IN [ MM. ]

MATERIAL  
MOLDED PLASTIC CASE

FINISH  
N/A

DO NOT SCALE DRAWING



MAGNETIC CONTACTOR

SIZE <b>A</b>	DWG. NO. BA40-30-10-51	REV. <b>A</b>
SCALE:1:3	WEIGHT:	SHEET 1 OF 1