



CONTACT US @ 855-355-2724

E-Mail: Sales@brahelectric.com

www.Brahelectric.com

PRODUCT DATA SHEET



RATING PLUGS

Picture is for reference only,
Actual Kit may vary slightly

PART NUMBER- BE-TR32S2400:

BE-TR32S2400, 2400-amp rating plug, type TR32, for use with 3200 amp CT sensor rating, suitable for General Electric Power Break I 3200 amp insulated frame types AKR75 equipped with MicroVersaTrip RMS-9 solid state electronic trip units, direct substitute rating plug for General Electric OEM TR32S2400.

PRODUCT SPECIFICATIONS

Manufacturer	BRAH Electric
Sub-Category	Rating Plugs
Family	Power Break 1
Type	TR32
Type For	AKR75
OEM Manufacturer	General Electric
OEM Part Number	TR32S2400
Amperage Min	2400
Amperage Max	2400
Trip type	MicroVersaTrip RMS-9

Warranty: All Products sold by BRAH Electric are guaranteed to be free of defect for a period of two years, under the condition that the product has been installed and operated properly. All items proven defective within the one year period will be replaced by BRAH Electric. In the event that we cannot provide a direct replacement, your monies will be refunded in full. We are not responsible for any consequential losses or damages outside of the defective product as well as any replacements or repairs performed by another party without our written authorization from BRAH Electric.

PRODUCT DIMENSIONS

REVISIONS				
ZONE	REV.	DESCRIPTION	DATE	APPROVED

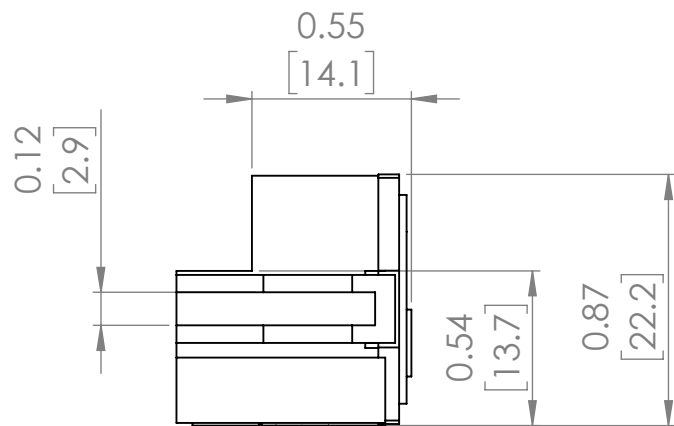
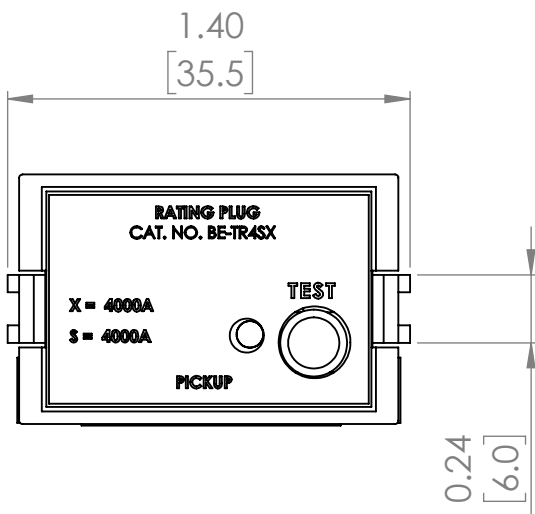
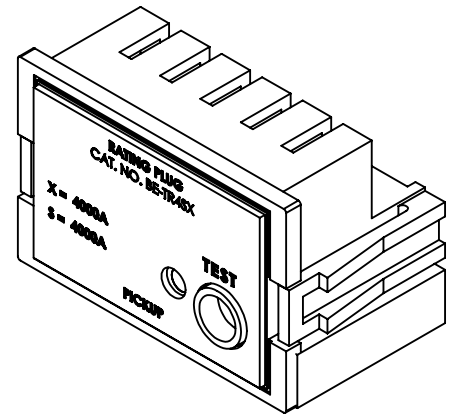
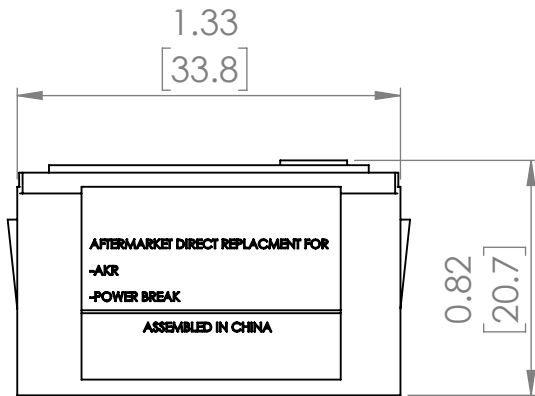

NOTE: BRAH ELECTRIC COILS ARE A DIRECT REPLACEMENT FOR GENERAL ELECTRIC, POWER BREAK 1, TYPE TR32,2400 Amp PLUG FOR 3200 Amp CT SENSOR RATING, SUITABLE FOR USE WITH AKR75 EQUIPPED WITH MICROVERSA TRIP RMS-9 SOLID STATE ELECTRONIC TRIP UNITS .

 THIRD ANGLE PROJECTION	UNLESS OTHERWISE NOTED ALL DIMENSIONS ARE IN INCHES METRIC UNITS ARE DISPLAYED BENEATH IN [MM.]	 RATING PLUGS
	PROPRIETARY AND CONFIDENTIAL THE INFORMATION CONTAINED IN THIS DRAWING IS THE SOLE PROPERTY OF BRAH ELECTRIC. ANY REPRODUCTION IN PART OR AS A WHOLE WITHOUT THE WRITTEN PERMISSION OF BRAH ELECTRIC IS PROHIBITED.	
SIZE A DWG. NO. BE-TR32S2400 REV. A		SCALE: 1:1 WEIGHT: 3.2 LBS SHEET 1 OF 1