



CONTACT US @ 855-355-2724

E-Mail: Sales@brahelectric.com

www.Brahelectric.com

PRODUCT DATA SHEET



Rating Plugs

Picture is for reference only,
Actual Kit may vary slightly

PART NUMBER- BE-TR40B2500

BE-TR40B2500, BRAH Electrical, Power Breaker II, type TR40, interchangeable rating plug, 2500A, to be Used with the 4000A Micro versa Trip Plus, Micro versa trip PM Programmer trip device, within PBII and Wave Pro- SSD, SHD, SSF, SHF, WPS, WPF, WPX Circuit breaker frame types.

PRODUCT SPECIFICATIONS

Manufacturer	BRAH Electric
Sub-Category	Rating Plugs
Family	Power Break II
Type	TR40
Type For	SSD, SHD, SSF, SHF, WPS, WPH, WPF, WPX
OEM Manufacturer	General Electric
Amperage Min	2500
Amperage Max	2500
Trip Type	Micro Versa Trip Plus, Micro Versa Trip PM

Warranty: All Products sold by BRAH Electric are guaranteed to be free of defect for a period of two years, under the condition that the product has been installed and operated properly. All items proven defective within the one year period will be replaced by BRAH Electric. In the event that we cannot provide a direct replacement, your monies will be refunded in full. We are not responsible for any consequential losses or damages outside of the defective product as well as any replacements or repairs performed by another party without our written authorization from BRAH Electric.

REVISIONS				
ZONE	REV.	DESCRIPTION	DATE	APPROVED

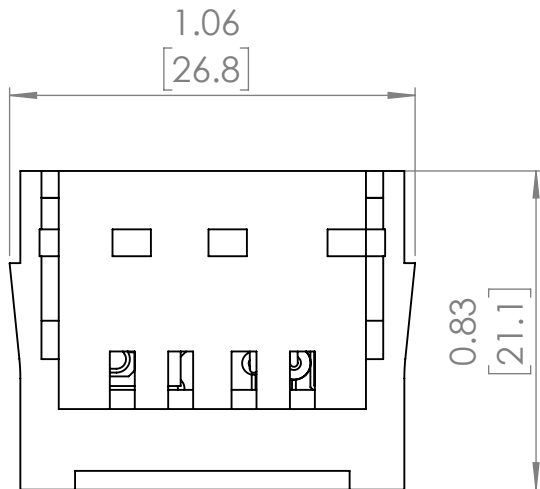
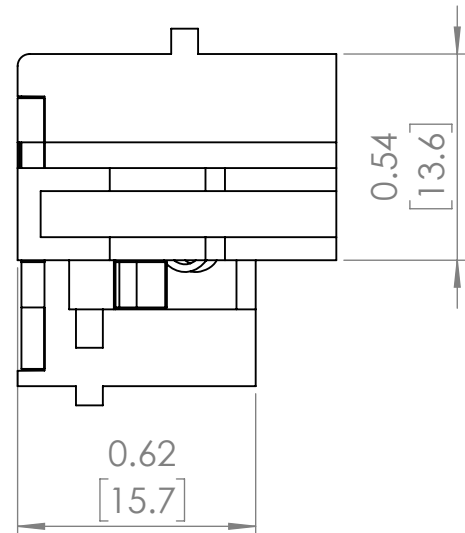
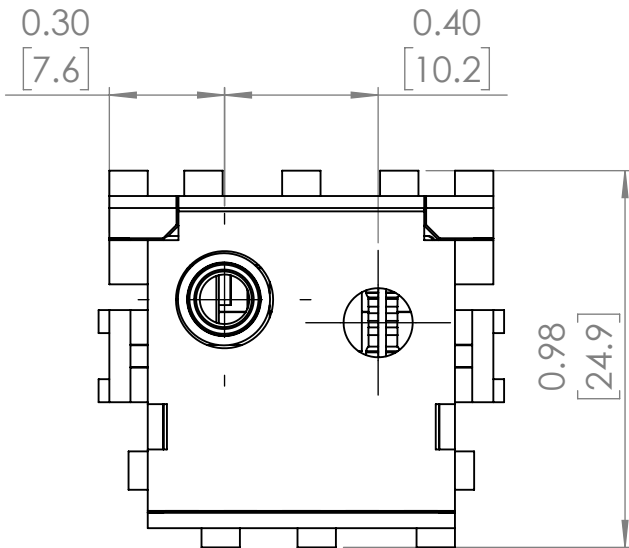
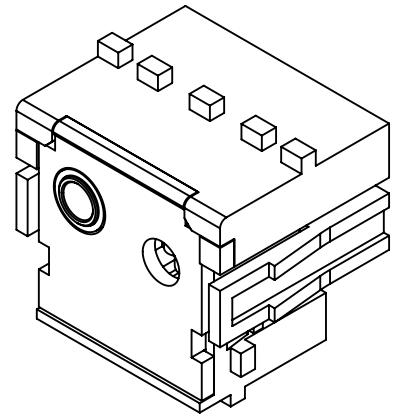

WWW.BRAHELECTRIC.COM, 855-355-2724

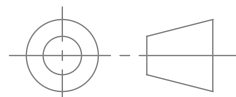

THIRD ANGLE PROJECTION

PROPRIETARY AND CONFIDENTIAL

THE INFORMATION CONTAINED IN THIS DRAWING IS THE SOLE PROPERTY OF BRAH ELECTRIC. ANY REPRODUCTION IN PART OR AS A WHOLE WITHOUT THE WRITTEN PERMISSION OF BRAH ELECTRIC IS PROHIBITED.

UNLESS OTHERWISE NOTED

ALL DIMENSIONS ARE IN INCHES
METRIC UNITS ARE DISPLAYED
BENEATH IN [MM.]

MATERIAL

FINISH

DO NOT SCALE DRAWING



RATING PLUGS

SIZE **A** DWG. NO.

BE-TR40B2500

REV. **A**

SCALE:2:1

WEIGHT: 3.2 LBS

SHEET 1 OF 1