

PRODUCT DATA SHEET



PART NUMBER - BEH-100: BRAH Electric, aftermarket direct replacement contactors for ABB EH-100, EH Series, type EH-100, 3P, 3PH, 120A, 600V, 40HP @ 240V, 75HP @ 480V, 100HP @ 600V, complete with 120V AC coil, 2 N/O - 2 N/C auxiliary contact, AC magnetic contactor, suitable for use with EH series motor control systems

PRODUCT SPECIFICATIONS

MAGNETIC CONTACTOR
PART NO. BEH-100

TYPE	VALUE (UNITS)	NOTES	COMMENTS
PHASE	3		
POLES	3		
VOLTAGE	600 (VAC)		
AMPERAGE	120 (A)		
COIL VOLTAGE MIN	120 (V)		
COIL VOLTAGE MAX	120 (V)		
MIN HP. RATING	40 (HP)	@ 240V	
MAX HP RATING	100 (HP)	@ 600V	

ADDITIONAL INFORMATION:

- * Interchangeable Coils with multiple coil voltages available; (24V, 48V, 120V, 208V, 240V, 277V, 380V, 480V, 600V)
- * Auxiliary contacts are arranged with screw type terminals
- * We use fine quality silver for our contacts, containing 95% silver content

Warranty: All Products sold by BRAH Electric are guaranteed to be free of defect for a period of one year, under the condition that the product has been installed and operated properly. All items proven defective within the one year period will be replaced by BRAH Electric. In the event that we cannot provide a direct replacement, your monies will be refunded in full. We are not responsible for any consequential losses or damages outside of the defective product as well as any replacements or repairs performed by another party without our written authorization from BRAH Electric

REVISIONS

ZONE	REV.	DESCRIPTION	DATE	APPROVED
------	------	-------------	------	----------

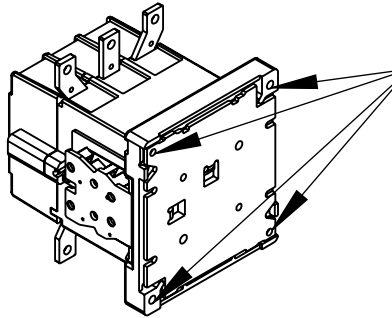

MOUNTING HOLES

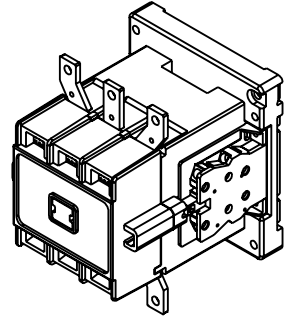

ISO VIEW

4.92
[125.0]

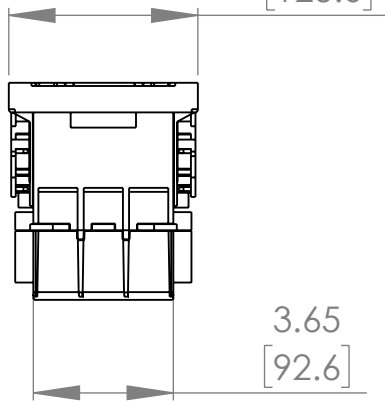

3.65
[92.6]

6X ϕ 0.25
[6.4]

4X ϕ 0.24
[6.0]

0.31
[8.0]

0.41
[10.5]

5.65
[143.5]

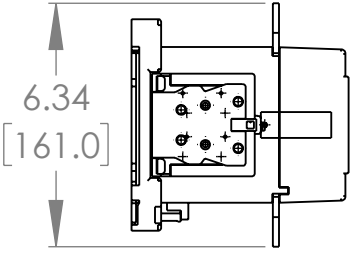

6.34
[161.0]

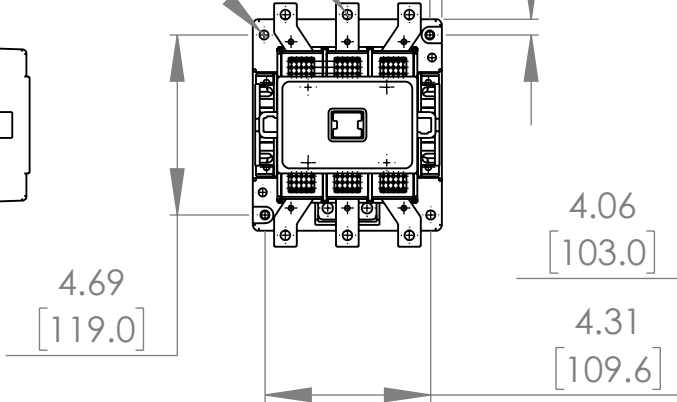

4.69
[119.0]

4.06
[103.0]

4.31
[109.6]

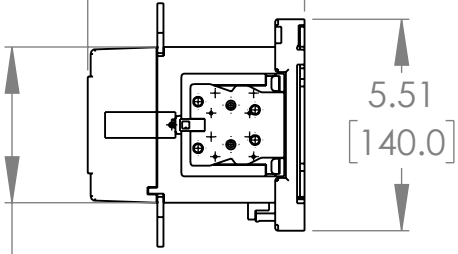

5.51
[140.0]

* NOTE: BRAH ELECTRIC CONTACTOR IS A DIRECT REPLACEMENT FOR ABB EH-100, EH SERIES. SUITABLE FOR USE WITH EH SERIES MOTOR CONTROL SYSTEMS

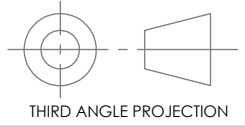

THIRD ANGLE PROJECTION

PROPRIETARY AND CONFIDENTIAL

THE INFORMATION CONTAINED IN THIS DRAWING IS THE SOLE PROPERTY OF BRAH ELECTRIC. ANY REPRODUCTION IN PART OR AS A WHOLE WITHOUT THE WRITTEN PERMISSION OF BRAH ELECTRIC IS PROHIBITED.

UNLESS OTHERWISE NOTED
ALL DIMENSIONS ARE IN INCHES
METRIC UNITS ARE DISPLAYED
BENEATH IN [MM.]

MATERIAL
MOLDED PLASTIC CASE

FINISH
N/A

DO NOT SCALE DRAWING



MAGNETIC CONTACTOR

SIZE A	DWG. NO. BEH-100	REV. A
SCALE: 1:5	WEIGHT:	SHEET 1 OF 1