



CONTACT US @ 855-355-2724

E-Mail: Sales@brahelectric.com

www.Brahelectric.com

PRODUCT DATA SHEET



Bus Plugs

Picture is for reference only,
Actual Kit may vary slightly

PART NUMBER – BEL3206GN:

BRAH Electric aftermarket SL422RG, 60 amp, 240 volt, 3 phase, 4 wire, with ground, fusible style bus plug, type BEL / SL, UL Listed assembly, complete with UL Recognized internal switch and components, suitable for use with OEM General Electric / ABB Spectra Low-Amp Series industrial busway systems, accepts Class H, R and J fuse types, direct substitute, fit and function for GE OEM SL422RG, SL422RGR, SL422RGJ



PRODUCT SPECIFICATIONS

Manufacturer	BRAH Electric
Sub-Category	Fusible
Type	SL, BEL
Wire	4
Voltage	240
Amperage	60
Suit Fuse	H, R
A/C Rating	200ka@240V
Phase	3

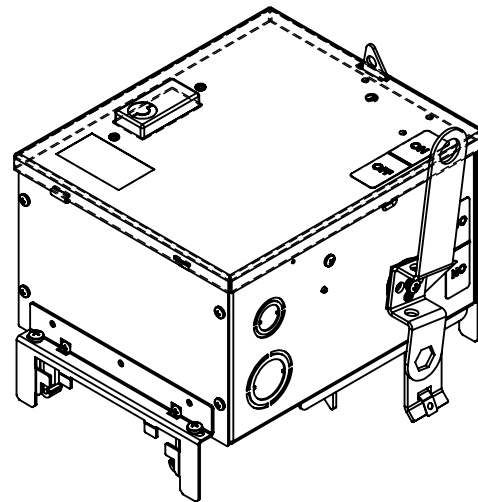
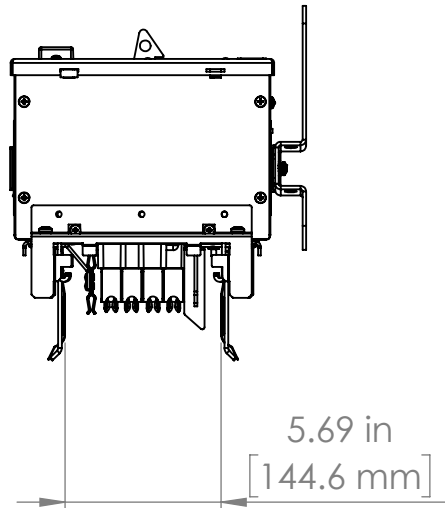
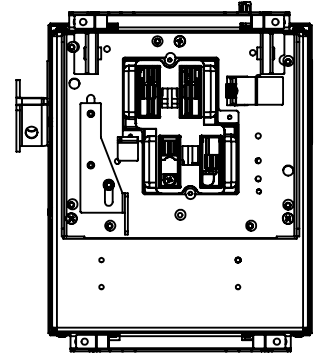
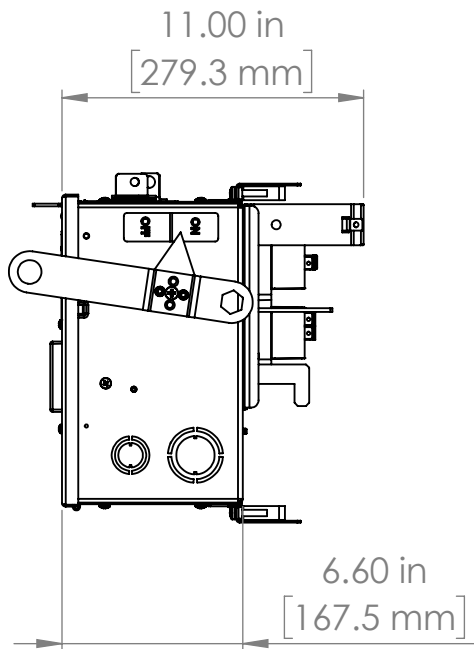
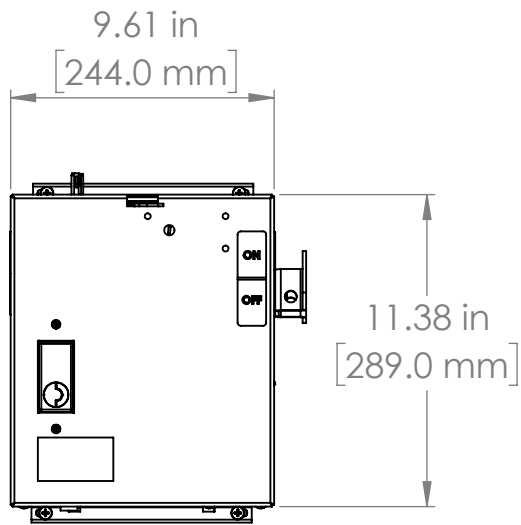
Warranty: All Products sold by BRAH Electric are guaranteed to be free of defect for a period of two years, under the condition that the product has been installed and operated properly. All items proven defective within the one year period will be replaced by BRAH Electric. In the event that we cannot provide a direct replacement, your monies will be refunded in full. We are not responsible for any consequential losses or damages outside of the defective product as well as any replacements or repairs performed by another party without our written authorization from BRAH Electric.

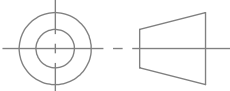

* NOTE: BRAH Electric aftermarketdirect SL422RG, 60amp, 240volt, 3 phase, 4 wire, fusible style bus plug, type BEL / SL, UL Listed assembly, complete with UL Recognized internal switch and components.

 THIRD ANGLE PROJECTION	UNLESS OTHERWISE NOTED ALL DIMENSIONS ARE IN INCHES METRIC UNITS ARE DISPLAYED BENEATH IN [MM.]					
	PROPRIETARY AND CONFIDENTIAL THE INFORMATION CONTAINED IN THIS DRAWING IS THE SOLE PROPERTY OF BRAH ELECTRIC. ANY REPRODUCTION IN PART OR AS A WHOLE WITHOUT THE WRITTEN PERMISSION OF BRAH ELECTRIC IS PROHIBITED.				FUSIBLE BUS BLUGS	
MATERIAL		FINISH		SIZE A	DWG. NO. BEL3206GN	REV. A
DO NOT SCALE DRAWING		SCALE: 1:10		WEIGHT:		SHEET 1 OF 1