

## PRODUCT DATA SHEET



**PART NUMBER – BLC1D1810-G7:** BRAH Electric, aftermarket direct replacement contactors for Telemecanique LC1D1810-G7, TeSys D Series, type LC1D, 3P, 3PH, 32A, 600V, complete with 110/120V AC coil voltage max 10 hp, 1 N/O auxiliary contact, AC magnetic contactor, suitable for use with LC1-D series motor control systems.

### PRODUCT SPECIFICATIONS

#### CONTACTORS

PART NO. BLC1D1810-G7

Manufacturer	BRAH Electric
Sub-Category	Contactors
Family	TeSys D
Type	BLC1D
Phase	3
Poles	3
Voltage	600
Amperage	32
Coil Voltage Max	10 (HP)

**Warranty:** All Products sold by BRAH Electric are guaranteed to be free of defect for a period of one year, under the condition that the product has been installed and operated properly. All items proven defective within the one year period will be replaced by BRAH Electric. In the event that we cannot provide a direct replacement, your monies will be refunded in full. We are not responsible for any consequential losses or damages outside of the defective product as well as any replacements or repairs performed by another party without our written authorization from BRAH Electric.

REVISIONS				
ZONE	DESCRIPTION	REV.	DATE	APPROVED

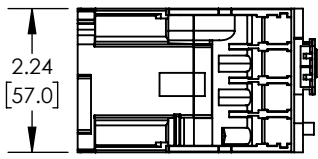
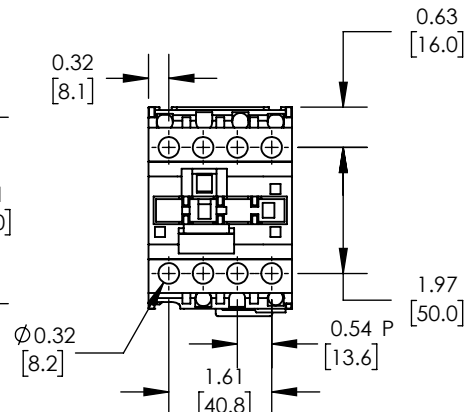
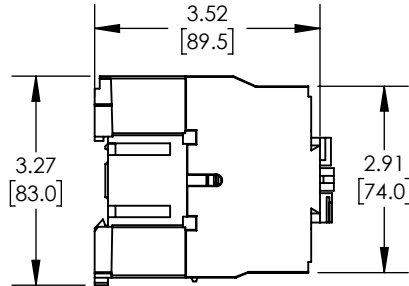
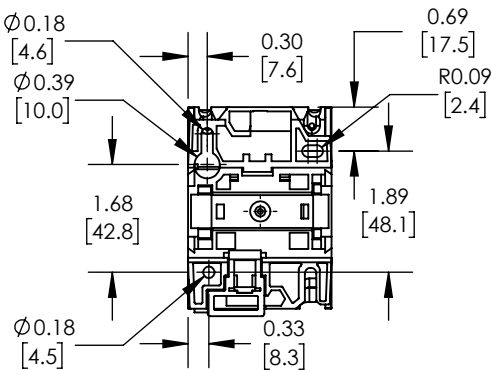
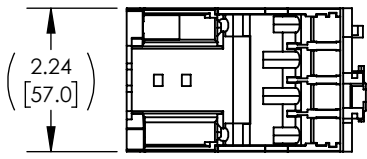
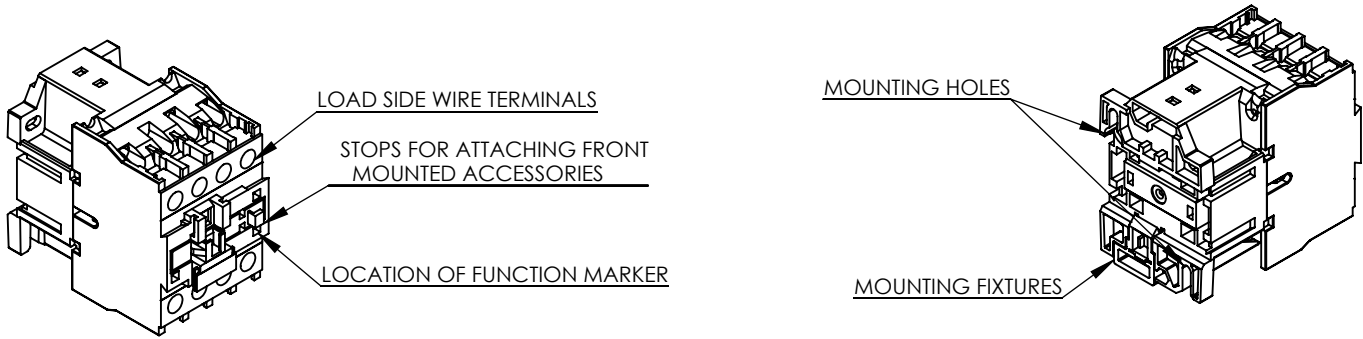

[WWW.BRAHELECTRIC.COM](http://WWW.BRAHELECTRIC.COM), 855-355-2724

\*NOTE: BRAH ELECTRIC CONTACTOR BLC1D1810-G7 IS AN AFTERMARKET DIRECTREPLACEMENT FOR LC1D1810-G7,SERIES. SUITABLE FOR USE WITH LC1-DSERIES MOTOR CONTROL SYSTEMS.

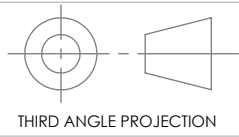

**PROPRIETARY AND CONFIDENTIAL**  
THE INFORMATION CONTAINED IN THIS DRAWING IS THE SOLE PROPERTY OF BRAH ELECTRIC. ANY REPRODUCTION IN PART OR AS A WHOLE WITHOUT THE WRITTEN PERMISSION OF BRAH ELECTRIC IS PROHIBITED.

UNLESS OTHERWISE NOTED  
ALL DIMENSIONS ARE IN INCHES  
METRIC UNITS ARE DISPLAYED  
BENEATH IN [ MM. ]

MATERIAL  
MOLDED PLASTIC CASE

FINISH  
N/A

DO NOT SCALE DRAWING



MAGNETIC CONTACTOR

SIZE <b>A</b>	DWG. NO. BLC1D1810-G7	REV. <b>A</b>
SCALE:1:3	WEIGHT: 3.2 LBS	SHEET 1 OF 1