

PRODUCT DATA SHEET



PART NUMBER – BLC1D3210-LE7: BRAH Electric, aftermarket direct replacement contactors for Telemecanique LC1D3210-LE7, TeSys D Series, type LC1D, 3P, 3PH, 50A, 600V, complete with 208V AC coil voltage max 20 hp, 1 N/O auxiliary contact, AC magnetic contactor, suitable for use with LC1-D series motor control systems.

PRODUCT SPECIFICATIONS

CONTACTORS

Voltage Selection Chart

BLC1D3210-XX

BLC1D3210	110/120VAC
BLC1D3210-B6	24VAC
BLC1D3210-B7	24VAC
BLC1D3210-E7	48VAC
BLC1D3210-G6	110/120VAC
BLC1D3210-G7	110/120VAC
BLC1D3210-LE7	208VAC
BLC1D3210-M6	220VAC
BLC1D3210-M7	220VAC
BLC1D3210-P7	230VAC
BLC1D3210-Q6	380VAC
BLC1D3210-Q7	380VAC
BLC1D3210-R7	440VAC
BLC1D3210-T6	480VAC
BLC1D3210-U6	240VAC
BLC1D3210-U7	240VAC
BLC1D3210-V7	400VAC

Manufacturer	BRAH Electric
Sub-Category	Contactors
Family	TeSys D
Type	BLC1D
Phase	3
Poles	3
Voltage	600
Amperage	50
Coil Voltage Max	20 (HP)

Warranty: All Products sold by BRAH Electric are guaranteed to be free of defect for a period of one year, under the condition that the product has been installed and operated properly. All items proven defective within the one year period will be replaced by BRAH Electric. In the event that we cannot provide a direct replacement, your monies will be refunded in full. We are not responsible for any consequential losses or damages outside of the defective product as well as any replacements or repairs performed by another party without our written authorization from BRAH Electric.

REVISIONS				
ZONE	DESCRIPTION	REV.	DATE	APPROVED

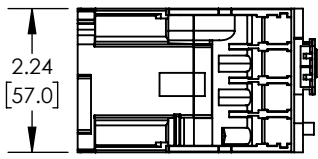
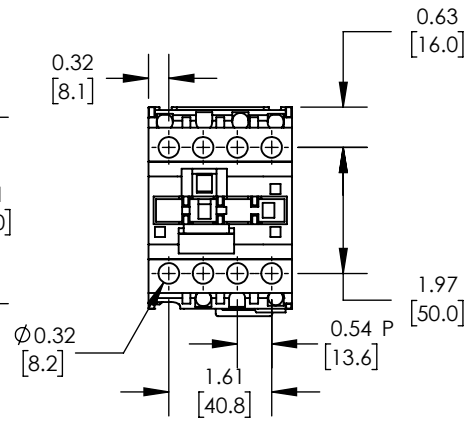
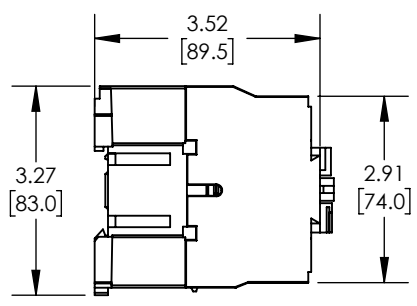
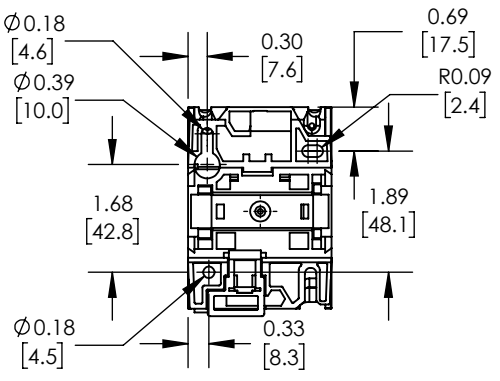
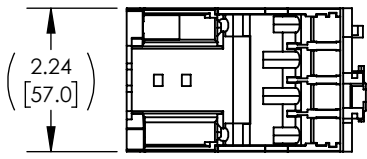
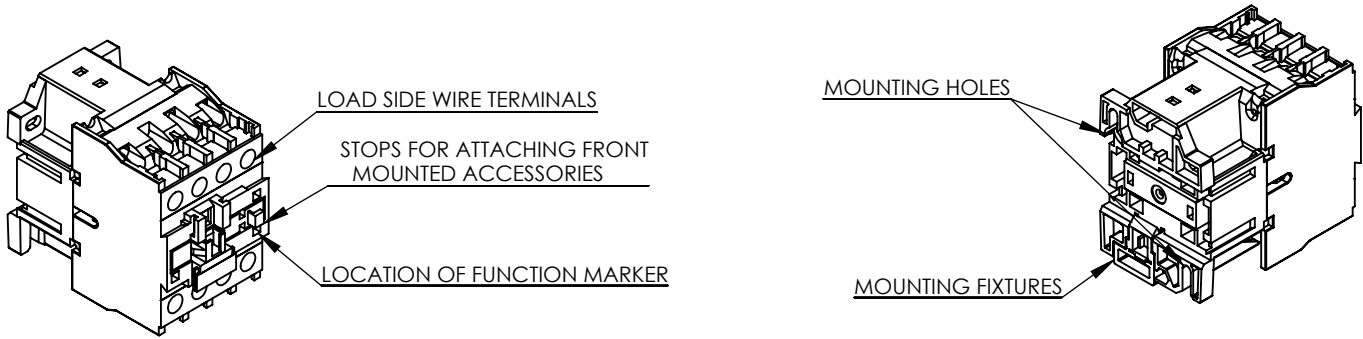

WWW.BRAHELECTRIC.COM, 855-355-2724

*NOTE: BRAH ELECTRIC CONTACTOR BLC1D3210-LE7 IS AN AFTERMARKET DIRECT REPLACEMENT FOR LC1D3210-LE7,SERIES.SUITABLE FOR USE WITH LC1-DSERIES MOTOR CONTROL SYSTEMS.

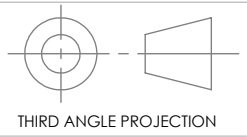

PROPRIETARY AND CONFIDENTIAL
THE INFORMATION CONTAINED IN THIS DRAWING IS THE SOLE PROPERTY OF BRAH ELECTRIC. ANY REPRODUCTION IN PART OR AS A WHOLE WITHOUT THE WRITTEN PERMISSION OF BRAH ELECTRIC IS PROHIBITED.

UNLESS OTHERWISE NOTED
ALL DIMENSIONS ARE IN INCHES
METRIC UNITS ARE DISPLAYED
BENEATH IN [MM.]

MATERIAL
MOLDED PLASTIC CASE

FINISH
N/A

DO NOT SCALE DRAWING

MAGNETIC CONTACTOR

SIZE A	DWG. NO. BLC1D3210-LE7	REV. A
SCALE:1:3	WEIGHT: 3.2 LBS	SHEET 1 OF 1