

PRODUCT DATA SHEET

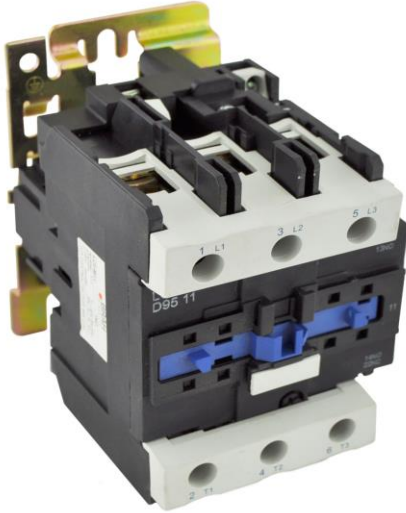

PART NUMBER – BLC1D9511-E7: BRAH Electric, aftermarket direct replacement contactors for Telemecanique LC1D9511-E7, TeSys D Series, type LC1D, 3P, 3PH, 125A, 600V, complete with 48V AC coil voltage max 60 hp, 1 N/O - 1 N/C auxiliary contact, AC magnetic contactor, suitable for use with LC1-D series motor control systems.

PRODUCT SPECIFICATIONS

CONTACTORS

PART NO. BLC1D9511-E7

Coil Voltage Selection Chart BLC1D9511-XX

BLC1D9511	110/120VAC
B6	24VAC
B7	24VAC
E7	48VAC
G6	110/120VAC
G7	110/120VAC
LE7	208V AC
M6	220V AC
M7	220V AC
P7	230VAC
Q6	380VAC
Q7	380VAC
R7	440VAC
T6	480VAC
U6	240VAC
U7	240VAC
V7	400VAC

Manufacturer	BRAH Electric
Sub-Category	Contactors
Family	TeSys D
Type	BLC1D
Phase	3
Poles	3
Voltage	600
Amperage	125
Max Coil Voltage	60 (HP)

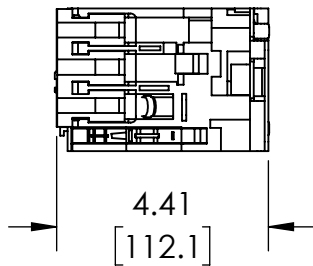
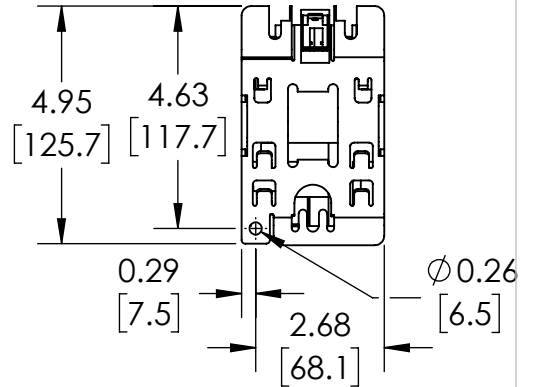
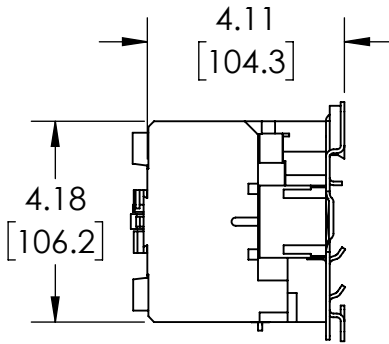
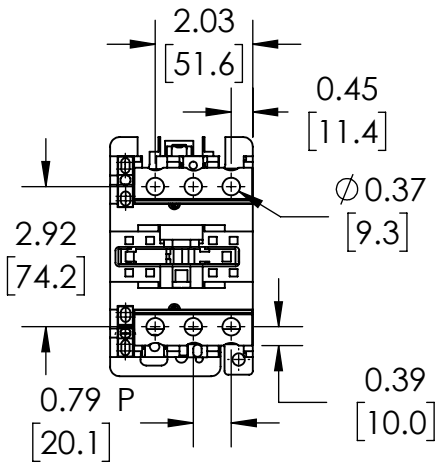
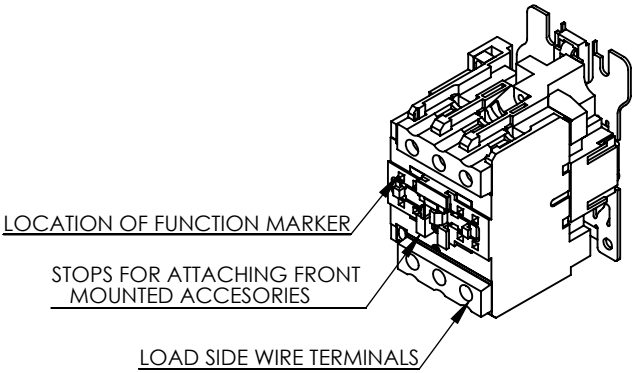
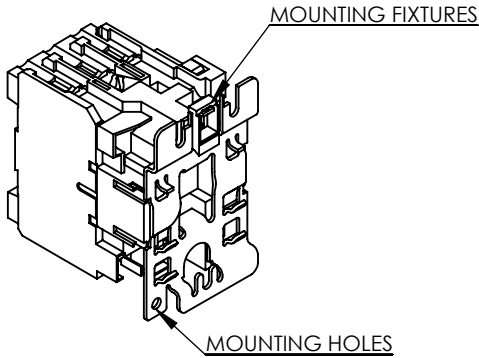

Warranty: All Products sold by BRAH Electric are guaranteed to be free of defect for a period of one year, under the condition that the product has been installed and operated properly. All items proven defective within the one year period will be replaced by BRAH Electric. In the event that we cannot provide a direct replacement, your monies will be refunded in full. We are not responsible for any consequential losses or damages outside of the defective product as well as any replacements or repairs performed by another party without our written authorization from BRAH Electric.

REVISIONS				
ZONE	REV.	DESCRIPTION	DATE	APPROVED

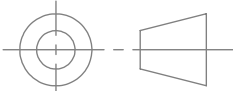

WWW.BRAHELECTRIC.COM, 855-355-2724

*NOTE: BRAH ELECTRIC CONTACTOR BLC1D9511-E7 IS AN AFTERMARKET DIRECT REPLACEMENT FOR LC1D9511-E7, LC1-D SERIES. SUITABLE FOR USE WITH LC1-D SERIES MOTOR CONTROL SYSTEMS

 THIRD ANGLE PROJECTION	UNLESS OTHERWISE NOTED ALL DIMENSIONS ARE IN INCHES METRIC UNITS ARE DISPLAYED BENEATH IN [MM.]	 BRAH Electric
	PROPRIETARY AND CONFIDENTIAL THE INFORMATION CONTAINED IN THIS DRAWING IS THE SOLE PROPERTY OF BRAH ELECTRIC. ANY REPRODUCTION IN PART OR AS A WHOLE WITHOUT THE WRITTEN PERMISSION OF BRAH ELECTRIC IS PROHIBITED.	
SIZE A DWG. NO. BLC1D9511-E7 REV. A		SCALE: 1:4 WEIGHT: 3.2 LBS SHEET 1 OF 1