



CONTACT US @ 855-355-2724

E-Mail: Sales@brahelectric.com

www.Brahelectric.com

PRODUCT DATA SHEET



PART NUMBER – BLR2D3359: BRAH Electric, aftermarket direct replacement solid state overload relays for Telemecanique LR2D3359, TeSys D Series, type LR2D, 3P, rated for 48.00 - 65.00A, 600V, suitable for use with 50 - 95A LC1D and LC2D contactors

MOTOR STARTER OVERLOAD RELAY
PART NO. BLR2D3359

PRODUCT SPECIFICATIONS

<i>TYPE</i>	<i>VALUE (UNITS)</i>	<i>NOTES</i>	<i>COMMENTS</i>
<i>PHASE</i>	3		
<i>POLES</i>	3		
<i>AMPERAGE MIN</i>	48.00 (A)		
<i>AMPERAGE MAX</i>	65.00 (A)		
<i>VOLTAGE RATING</i>	600V AC		
<i>TRIP CURRENT</i>	125% OF DIAL SETTING		
<i>SUITABLE FOR USE WITH</i>	50 - 95A LC1D and LC2D contactors		
<i>RELAY STYLE</i>	SOLID STATE		

Warranty: All Products sold by BRAH Electric are guaranteed to be free of defect for a period of one year, under the condition that the product has been installed and operated properly. All items proven defective within the one year period will be replaced by BRAH Electric. In the event that we cannot provide a direct replacement, your monies will be refunded in full. We are not responsible for any consequential losses or damages outside of the defective product as well as any replacements or repairs performed by another party without our written authorization from BRAH Electric.

REVISIONS				
ZONE	REV.	DESCRIPTION	DATE	APPROVED

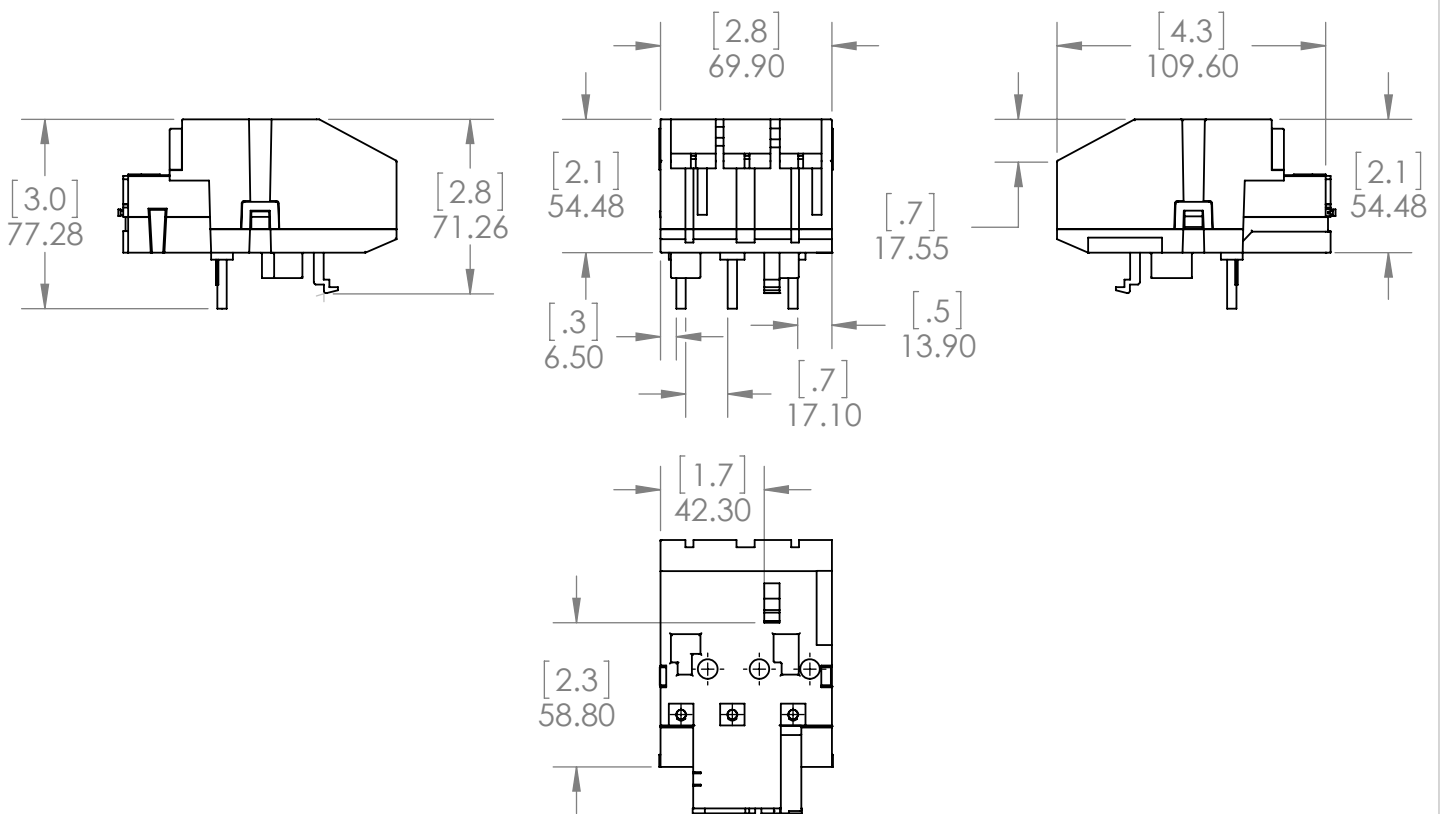
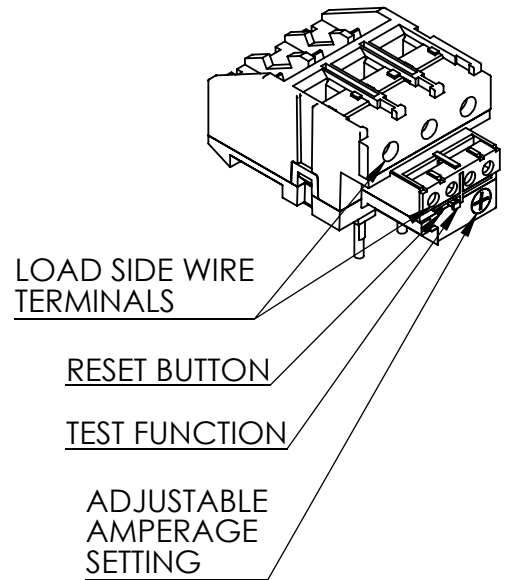
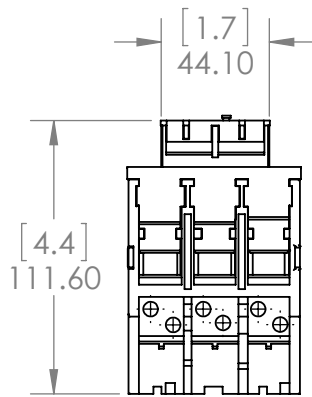
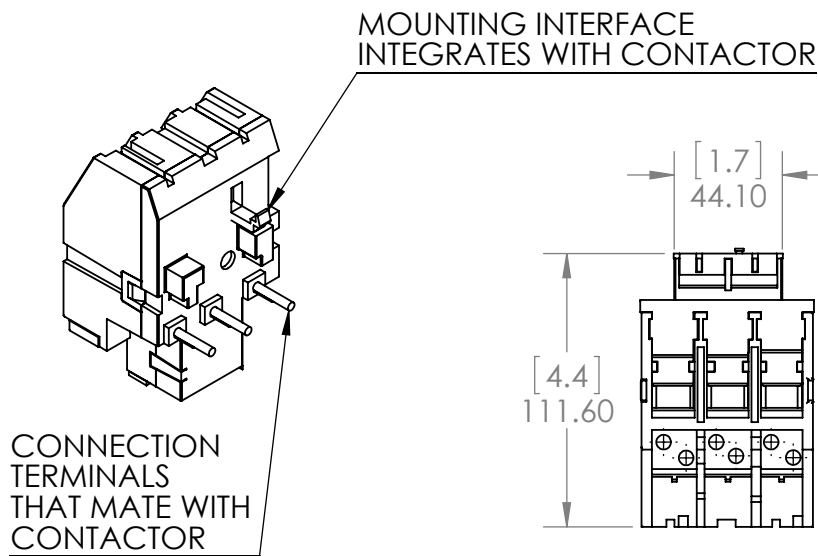

WWW.BRAHELECTRIC.COM, 855-355-2724

*NOTE: BRAH ELECTRIC OVERLOAD RELAY BLR2D3359 AN AFTERMARKET DIRECT REPLACEMENT FOR LR2D3359.SUITABLE FOR USE WITH LC1D AND LC2D CONTACTORS

THIRD ANGLE PROJECTION

PROPRIETARY AND CONFIDENTIAL

THE INFORMATION CONTAINED IN THIS DRAWING IS THE SOLE PROPERTY OF BRAH ELECTRIC. ANY REPRODUCTION IN PART OR AS A WHOLE WITHOUT THE WRITTEN PERMISSION OF BRAH ELECTRIC IS PROHIBITED.

UNLESS OTHERWISE NOTED
ALL DIMENSIONS ARE IN INCHES
METRIC UNITS ARE DISPLAYED
BENEATH IN [MM.]

MATERIAL
MOLDED PLASTIC CASE

FINISH
N/A

DO NOT SCALE DRAWING



OVERLOAD RELAY

SIZE A	DWG. NO. BLR2D3359	REV. A
SCALE:1:3	WEIGHT: 3.2 LBS	SHEET 1 OF 1