



CONTACT US @ 855-355-2724

E-Mail: [Sales@brahelectric.com](mailto:Sales@brahelectric.com)

[www.Brahelectric.com](http://www.Brahelectric.com)

## PRODUCT DATA SHEET



**PART NUMBER – BLR2D3365:** BRAH Electric, aftermarket direct replacement solid state overload relays for Telemecanique LR2D3365, TeSys D Series, type LR2D, 3P, rated for 80.00 - 93.00A, 600V, suitable for use with 65 - 95A LC1D and LC2D contactors

MOTOR STARTER OVERLOAD RELAY  
PART NO. BLR2D3365

### **PRODUCT SPECIFICATIONS**

<i>TYPE</i>	<i>VALUE (UNITS)</i>	<i>NOTES</i>	<i>COMMENTS</i>
<i>PHASE</i>	3		
<i>POLES</i>	3		
<i>AMPERAGE MIN</i>	80.00 (A)		
<i>AMPERAGE MAX</i>	93.00 (A)		
<i>VOLTAGE RATING</i>	600V AC		
<i>TRIP CURRENT</i>	125% OF DIAL SETTING		
<i>SUITABLE FOR USE WITH</i>	65 - 95A LC1D and LC2D contactors		
<i>RELAY STYLE</i>	SOLID STATE		

**Warranty:** All Products sold by BRAH Electric are guaranteed to be free of defect for a period of one year, under the condition that the product has been installed and operated properly. All items proven defective within the one year period will be replaced by BRAH Electric. In the event that we cannot provide a direct replacement, your monies will be refunded in full. We are not responsible for any consequential losses or damages outside of the defective product as well as any replacements or repairs performed by another party without our written authorization from BRAH Electric.

REVISIONS				
ZONE	REV.	DESCRIPTION	DATE	APPROVED

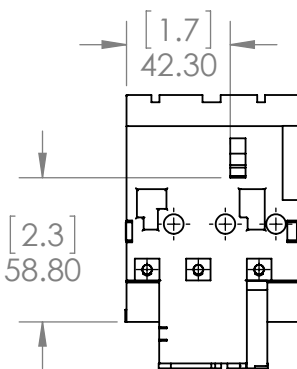
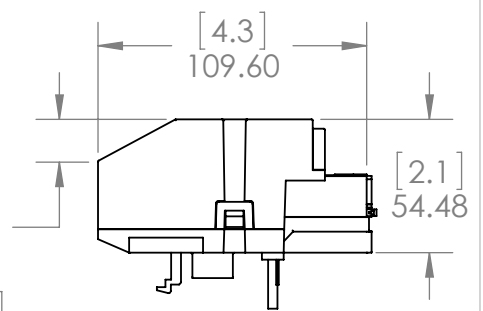
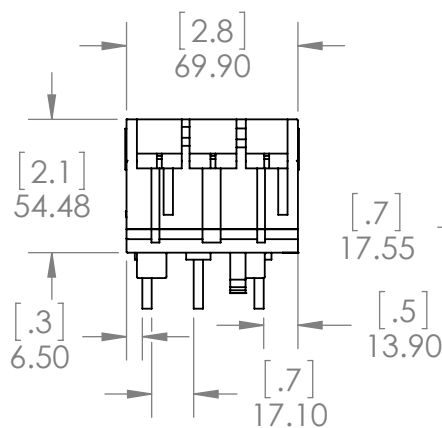
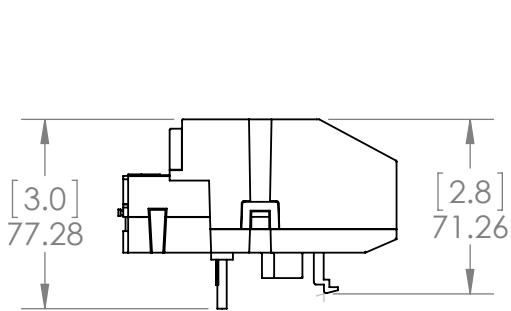
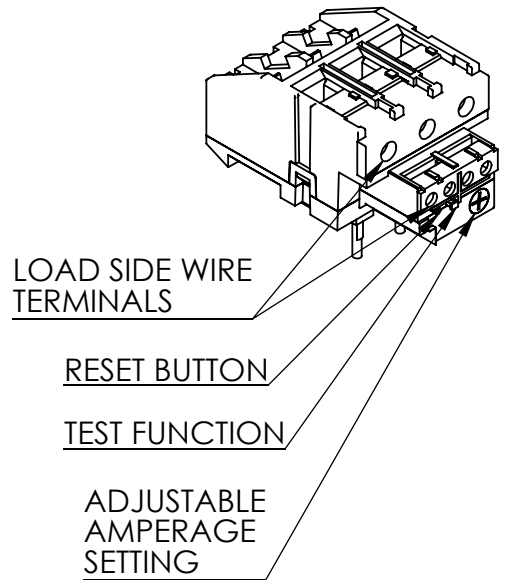
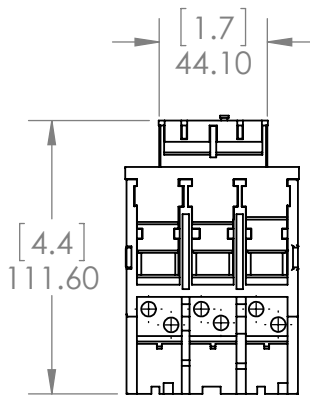
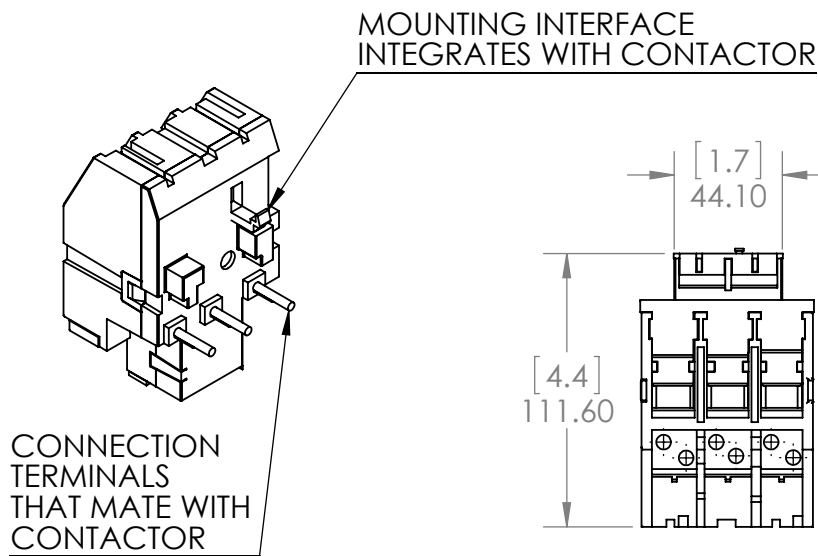

[WWW.BRAHELECTRIC.COM](http://WWW.BRAHELECTRIC.COM), 855-355-2724

\*NOTE: BRAH ELECTRIC OVERLOAD RELAY BLR2D3365 AN AFTERMARKET DIRECT REPLACEMENT FOR LR2D3365.SUITABLE FOR USE WITH LC1D AND LC2D CONTACTORS

THIRD ANGLE PROJECTION

**PROPRIETARY AND CONFIDENTIAL**

THE INFORMATION CONTAINED IN THIS DRAWING IS THE SOLE PROPERTY OF BRAH ELECTRIC. ANY REPRODUCTION IN PART OR AS A WHOLE WITHOUT THE WRITTEN PERMISSION OF BRAH ELECTRIC IS PROHIBITED.

UNLESS OTHERWISE NOTED  
ALL DIMENSIONS ARE IN INCHES  
METRIC UNITS ARE DISPLAYED  
BENEATH IN [ MM. ]

MATERIAL  
MOLDED PLASTIC CASE

FINISH  
N/A

DO NOT SCALE DRAWING

**BRAH**  
Electric

OVERLOAD RELAY

SIZE <b>A</b>	DWG. NO. BLR2D3365	REV. <b>A</b>
SCALE:1:3	WEIGHT: 3.2 LBS	SHEET 1 OF 1