



CONTACT US @ 855-355-2724

E-Mail: [Sales@brahelectric.com](mailto:Sales@brahelectric.com)

[www.Brahelectric.com](http://www.Brahelectric.com)

## PRODUCT DATA SHEET

---



CONTACT KITS

Picture is for reference only,  
Actual Kit may vary slightly

### **PART NUMBER- BZL75:**

BRAH Electric direct replacement contact kit. 3 Pole, rated for 105 Amp, 600 Volt max, suitable for NEMA size 0 motor starters & contactors, suitable with ABB A-Line model types A75, AE75, AF75. Complete assembly kit includes all contacts and related mounting screws & hardware. Kit directly replaces Furnas OEM ZL75

### **PRODUCT SPECIFICATIONS**

Manufacturer	BRAH Electric
Sub-Category	Contact Kits
Family	A-Line
Type	BZL
Type For	A75, AE75, AF75
OEM Manufacturer	ABB
OEM Part Number	ZL75
Poles	3
Amperage Max	105
Voltage Max	600
NEMA size	0

**Warranty:** All Products sold by BRAH Electric are guaranteed to be free of defect for a period of two years, under the condition that the product has been installed and operated properly. All items proven defective within the one year period will be replaced by BRAH Electric. In the event that we cannot provide a direct replacement, your monies will be refunded in full. We are not responsible for any consequential losses or damages outside of the defective product as well as any replacements or repairs performed by another party without our written authorization from BRAH Electric.

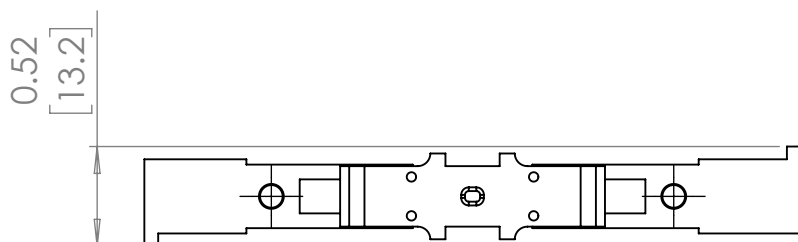
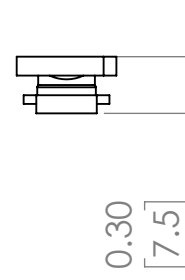
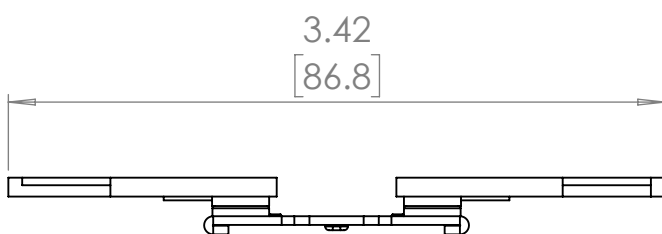
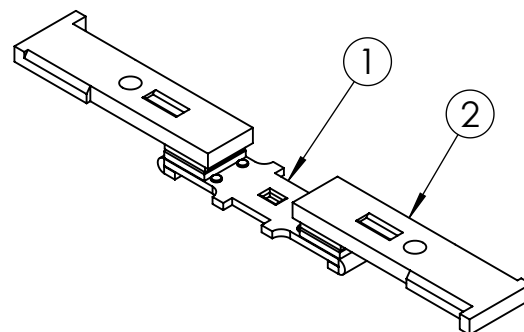
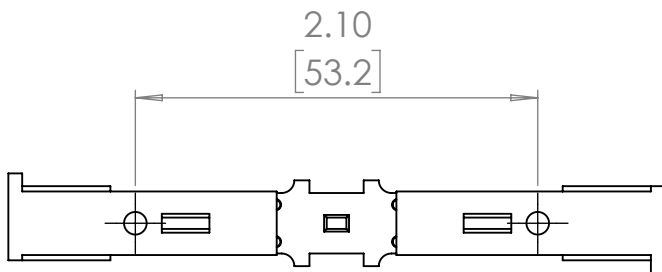

REVISIONS				
ZONE	REV.	DESCRIPTION	DATE	APPROVED



ITEM NO.	PART NUMBER	DESCRIPTION	VENDOR	QTY.
1	BZL75	Contact Kit	BRAH	3
2	BZL75-01	Contact Kit	BRAH	6

\* NOTE: BRAH Electric, aftermarket direct replacement contact kits for ABB , Type BZL, 3 pole kit, suitable for use with ABB A-Line model types A75, AE75, AF75 magnetic contactors & motor starters, NEMA size 0, rated for 600V maximum of 105 Amp.

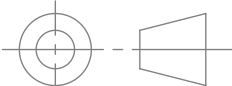
[WWW.BRAHELECTRIC.COM](http://WWW.BRAHELECTRIC.COM) , 855-355-2724

 THIRD ANGLE PROJECTION	UNLESS OTHERWISE NOTED ALL DIMENSIONS ARE IN INCHES METRIC UNITS ARE DISPLAYED BENEATH IN [ MM. ]		 <b>Contact Kit</b>		
	PROPRIETARY AND CONFIDENTIAL THE INFORMATION CONTAINED IN THIS DRAWING IS THE SOLE PROPERTY OF BRAH ELECTRIC. ANY REPRODUCTION IN PART OR AS A WHOLE WITHOUT THE WRITTEN PERMISSION OF BRAH ELECTRIC IS PROHIBITED.	MATERIAL N/A			FINISH N/A
DO NOT SCALE DRAWING			SCALE: 1:1	WEIGHT: 0.003 LBS	SHEET 1 OF 1