



CONTACT US

855.355.2724

E-Mail: sales@brahelectric.com

www.brahelectric.com

PRODUCT DATA SHEET



PART NUMBER – BE-SRPG600A450

BE-SRPG600A450, 450A rating plug, type SRPG for use with 600A CT sensor rating. Direct substitute for General Electric Spectra Series interchangeable rating plug element SRPG600A450. Suitable for use with Spectra RMS trip devices. Compatible with SGDA, SGHA, SGLA, SGPA circuit breaker frame types.

RATING PLUGS

PART NO. BE-SRPG600A450

RATING PLUG INST. ADJUST RANGE

LOW – 1375A	2695A
1735A	3530A
2185A	HI – 4555A

PRODUCT SPECIFICATIONS

Manufacturer	BRAH Electric
Sub-Category	Rating Plugs
Family	Spectra Series
Type	SRPG
For Frame Size	SGDA, SGHA, SGLA, SGPA
OEM Manufacturer	General Electric
OEM Part No.	SRPG600A450
Amperage Max	450
Trip Type	Spectra RMS
SAmp	600
PAmp	450

Warranty: All Products sold by BRAH Electric are guaranteed to be free of defect for a period of two years, under the condition that the product has been installed and operated properly. All items proven defective within the one year period will be replaced by BRAH Electric. In the event that we cannot provide a direct replacement, your monies will be refunded in full. We are not responsible for any consequential losses or damages outside of the defective product as well as any replacements or repairs performed by another party without our written authorization from BRAH Electric.

REVISIONS				
ZONE	REV.	DESCRIPTION	DATE	APPROVED

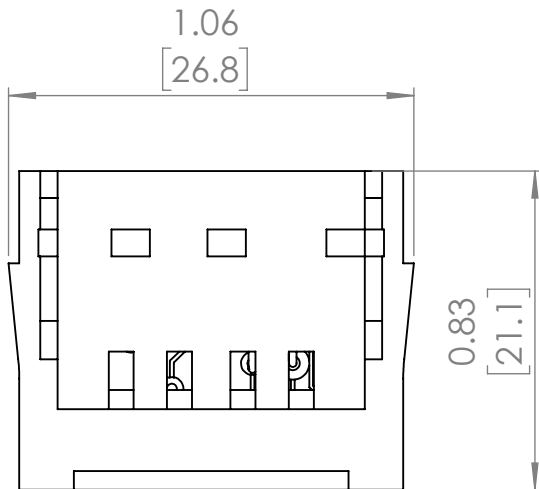
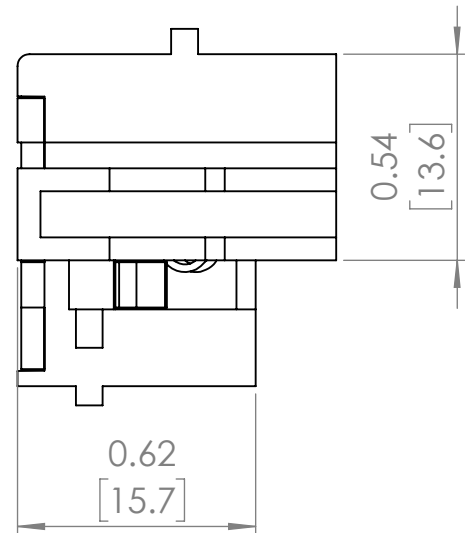
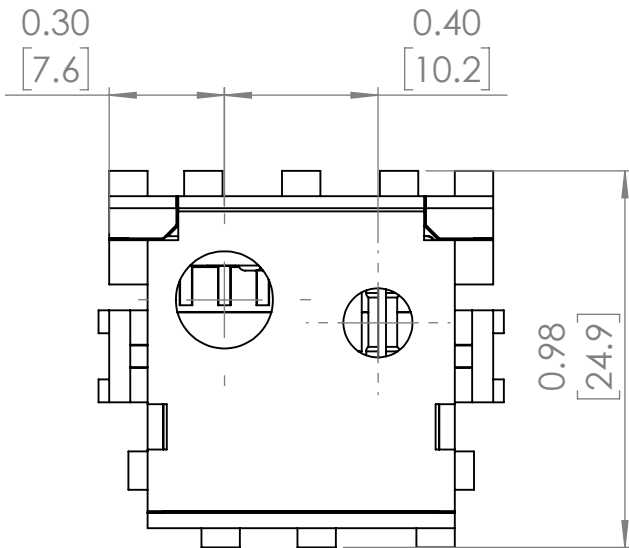
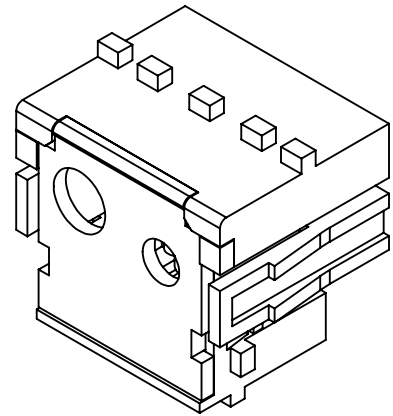

WWW.BRAHELECTRIC.COM, 855-355-2724

Drawing diagrams are for reference only.

Actual Kit may vary slightly

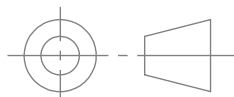

THIRD ANGLE PROJECTION

PROPRIETARY AND CONFIDENTIAL

THE INFORMATION CONTAINED IN THIS DRAWING IS THE SOLE PROPERTY OF BRAH ELECTRIC. ANY REPRODUCTION IN PART OR AS A WHOLE WITHOUT THE WRITTEN PERMISSION OF BRAH ELECTRIC IS PROHIBITED.

UNLESS OTHERWISE NOTED
ALL DIMENSIONS ARE IN INCHES
METRIC UNITS ARE DISPLAYED
BENEATH IN [MM.]

MATERIAL

FINISH

DO NOT SCALE DRAWING



RATING PLUGS

SIZE	DWG. NO.	REV.
A	BE-SRPG600A450	A
SCALE: 2:1	WEIGHT: 3.2 LBS	SHEET 1 OF 1