



CONTACT US

855.355.2724

E-Mail: sales@brahelectric.com

www.brahelectric.com

PRODUCT DATA SHEET



BUS PLUGS

PART NO. BPQ3603N

PART NUMBER – BPQ3603N

BRAH Electric aftermarket PQ3603N, 30A, 600V, 3 phase, 4, wire, fusible style bus plug, type PQ, BPQ, suitable for use with OEM Schneider Electric (Square D) I-Line I & II, industrial busway systems, accepts Class H, R and J fuse types, direct substitute, fit and function for Square D PQ3603N.

PRODUCT SPECIFICATIONS

Manufacturer	BRAH Electric
Sub-Category	Fusible
Type	PQ, BPQ
Suitable Replacement For	Square D PQ3603N
Wire	4
Voltage	600V
Amperage	30A
Suitable Fuse	H, J, R
A/C Rating	200 kA@480V
Phase	3

Warranty: All Products sold by BRAH Electric are guaranteed to be free of defect for a period of two years, under the condition that the product has been installed and operated properly. All items proven defective within the one year period will be replaced by BRAH Electric. In the event that we cannot provide a direct replacement, your monies will be refunded in full. We are not responsible for any consequential losses or damages outside of the defective product as well as any replacements or repairs performed by another party without our written authorization from BRAH Electric.

4

3

2

1

REVISIONS				
ZONE	REV.	DESCRIPTION	DATE	APPROVED

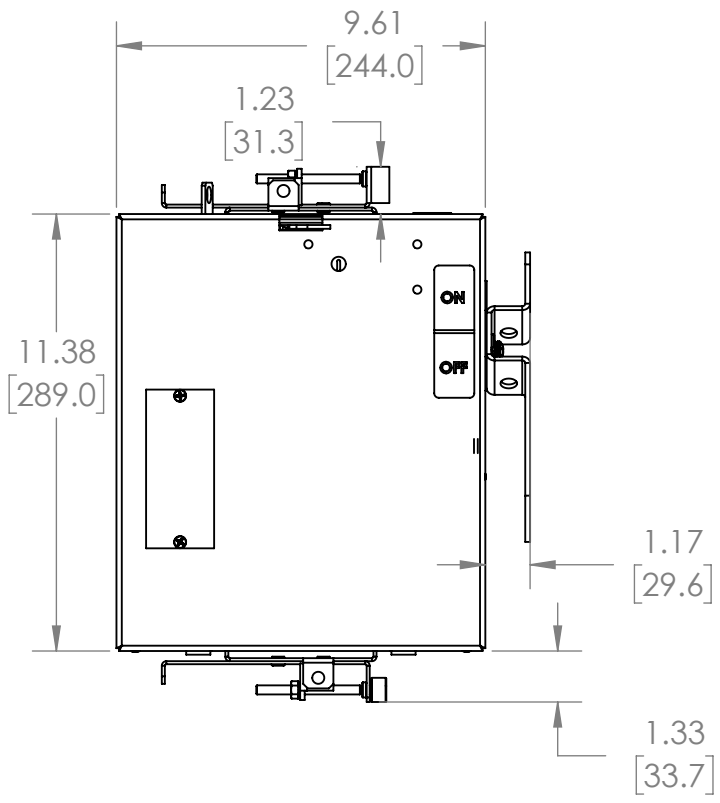
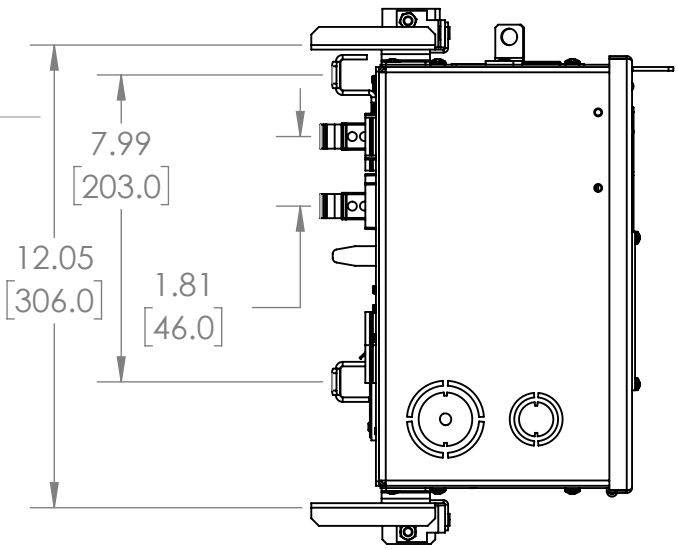
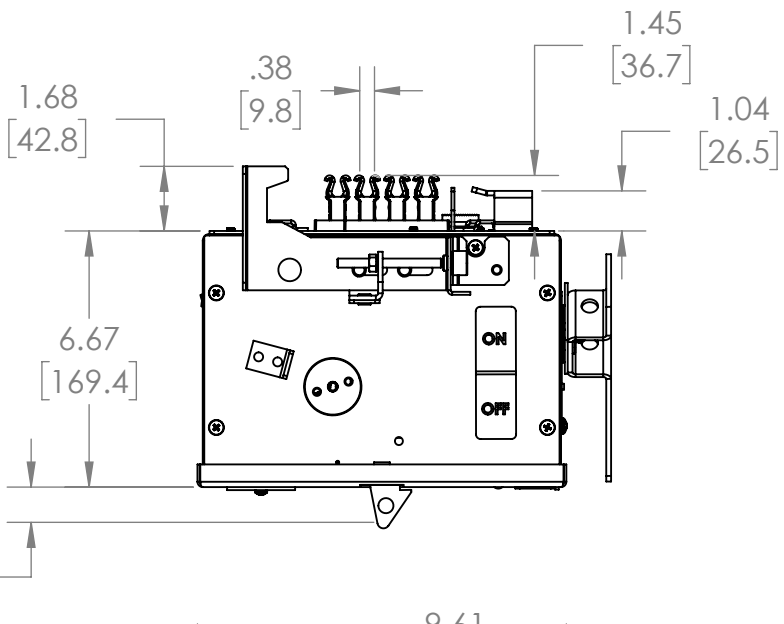
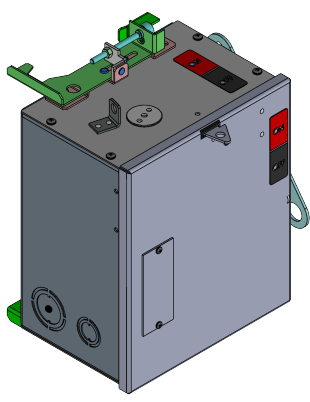

WWW.BRAHELECTRIC.COM, 855-355-2724

<p>THIRD ANGLE PROJECTION</p>	<p>TOLERANCES</p> <p>ANGULAR MACH ± .5°</p> <p>LINEAR</p> <p>X: ± .02 [.5]</p> <p>X.X: ± .01 [.25]</p> <p>X.XX: ± .005 [.13]</p>	<p>UNLESS OTHERWISE NOTED</p> <p>ALL DIMENSIONS ARE IN INCHES</p> <p>METRIC UNITS ARE DISPLAYED</p> <p>BENEATH IN [MM.]</p>	<p>FUSIBLE BUS PLUG</p>
	<p>GENERAL TOLERANCE</p> <p>ASME Y14.5M-1994</p>	<p>MATERIAL</p> <p>N/A</p> <p>FINISH</p> <p>N/A</p> <p>DRAWN BY</p> <p>MHENRY</p> <p>DATE</p> <p>6/20/2024</p>	
<p>PROPRIETARY AND CONFIDENTIAL</p> <p>THE INFORMATION CONTAINED IN THIS DRAWING IS THE SOLE PROPERTY OF BRAH ELECTRIC. ANY REPRODUCTION IN PART OR AS A WHOLE WITHOUT THE WRITTEN PERMISSION OF BRAH ELECTRIC IS PROHIBITED.</p>		<p>SIZE</p> <p>A</p>	<p>DWG. NO.</p> <p>BPQ3603N</p>
<p>DO NOT SCALE DRAWING</p>		<p>SCALE:1:5</p>	<p>REV.</p> <p>A</p> <p>SHEET 1 OF 1</p>

4

3

2

1