



CONTACT US

855.355.2724

E-Mail: sales@brahelectric.com

www.brahelectric.com

PRODUCT DATA SHEET



BUS PLUGS

PART NO. BEC3210

PART NUMBER – BEC3210

BRAH Electric aftermarket AC323R, 100 amp, 240 volt, 3 phase, 3 wire, fusible style bus plug, type BEC / AC, UL Listed assembly, complete with UL Recognized internal switch and components, suitable for use with OEM General Electric / ABB Armor Clad industrial busway systems, accepts Class H, R and J fuse types, direct substitute, fit and function for GE OEM AC323R, AC323RJ, AC1323, AC1323R, AC1323RJ



PRODUCT SPECIFICATIONS

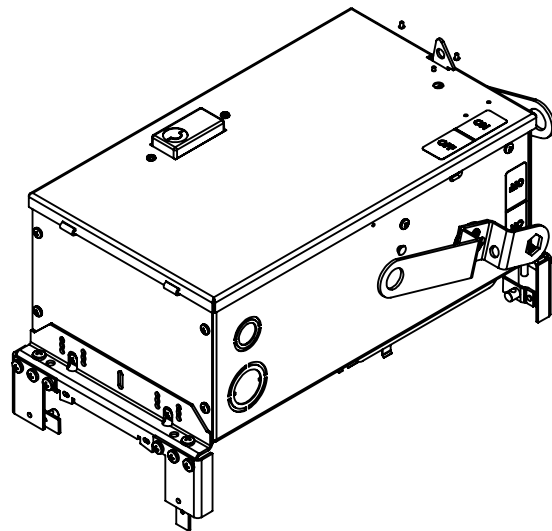
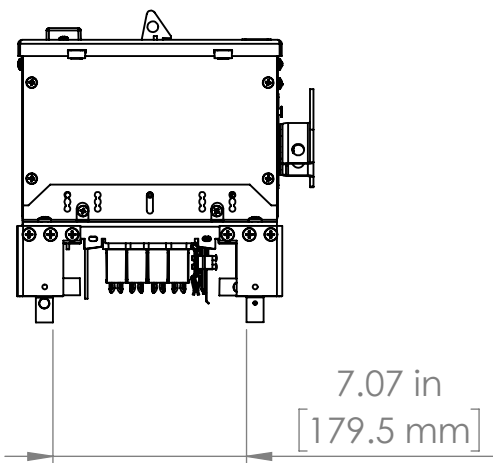
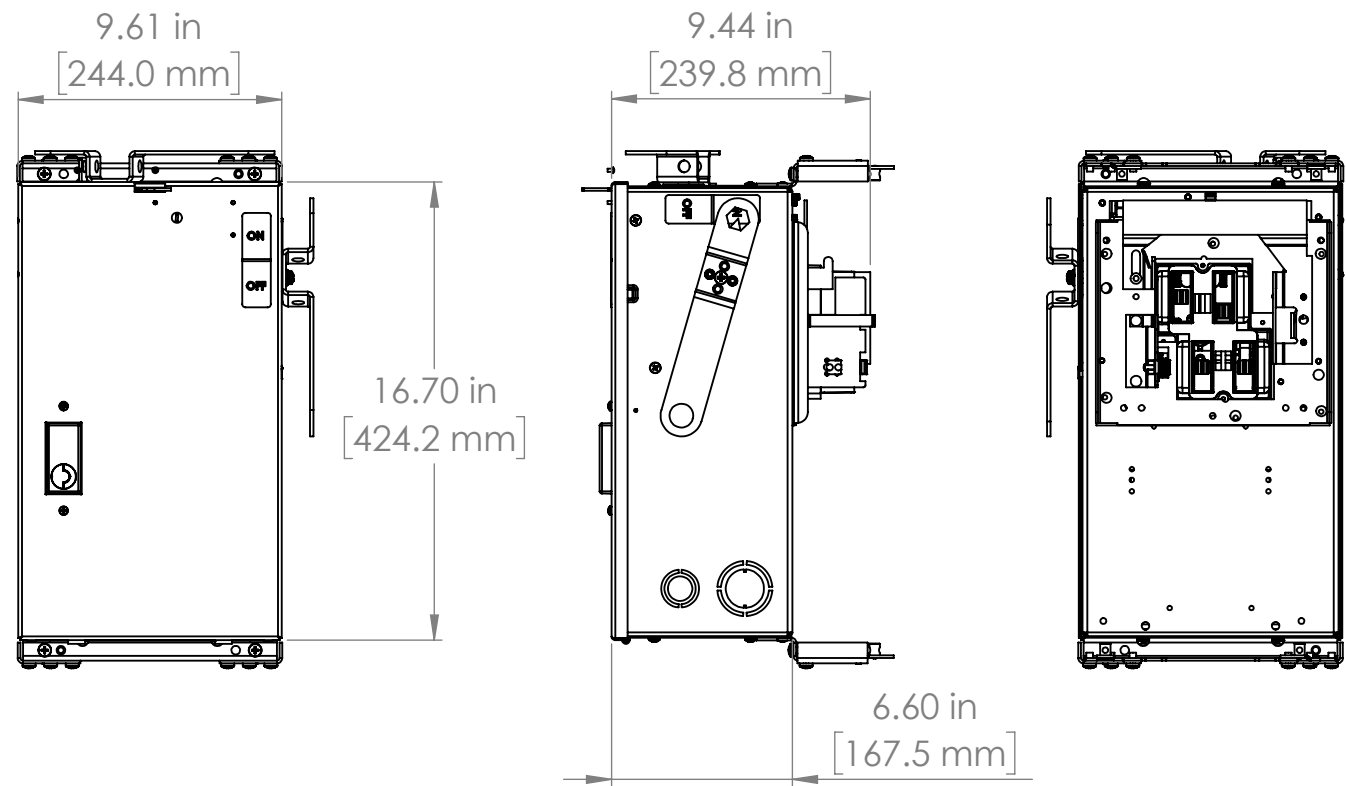

Manufacturer	BRAH Electric
Sub-Category	Fusible
Type	AC, BEC
Wire	3
Voltage	240V
Amperage	100A
Suitable Fuse	H, J, R
A/C Rating	200 kA@240V
Phase	3

Warranty: All Products sold by BRAH Electric are guaranteed to be free of defect for a period of two years, under the condition that the product has been installed and operated properly. All items proven defective within the one year period will be replaced by BRAH Electric. In the event that we cannot provide a direct replacement, your monies will be refunded in full. We are not responsible for any consequential losses or damages outside of the defective product as well as any replacements or repairs performed by another party without our written authorization from BRAH Electric.



* NOTE: BRAH Electric aftermarket AC323R, 100amp, 240volt, 3 phase, 3 wire, fusible style bus plug, type BEC / AC, UL Listed assembly, complete with UL Recognized internal switch and components.

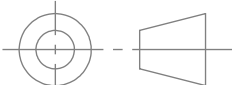

 THIRD ANGLE PROJECTION	UNLESS OTHERWISE NOTED ALL DIMENSIONS ARE IN INCHES METRIC UNITS ARE DISPLAYED BENEATH IN [MM.]		 FUSIBLE BUS BLUGS	
	PROPRIETARY AND CONFIDENTIAL THE INFORMATION CONTAINED IN THIS DRAWING IS THE SOLE PROPERTY OF BRAH ELECTRIC. ANY REPRODUCTION IN PART OR AS A WHOLE WITHOUT THE WRITTEN PERMISSION OF BRAH ELECTRIC IS PROHIBITED.			
	FINISH N/A	DO NOT SCALE DRAWING	SIZE A DWG. NO. BEC3210	REV. A
			SCALE: 1:10	WEIGHT:
			SHEET 1 OF 1	