

A1

A1

A1

A1

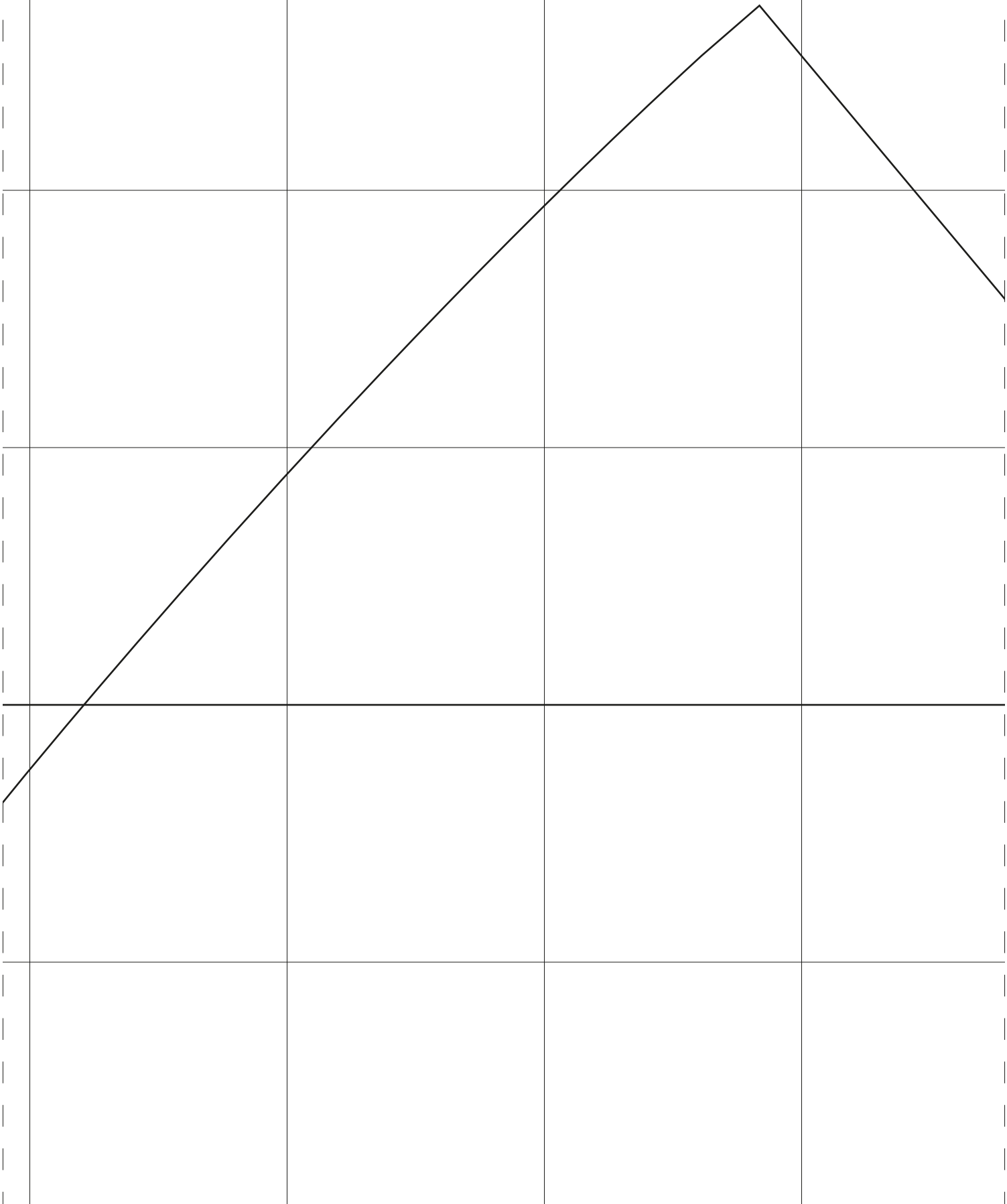

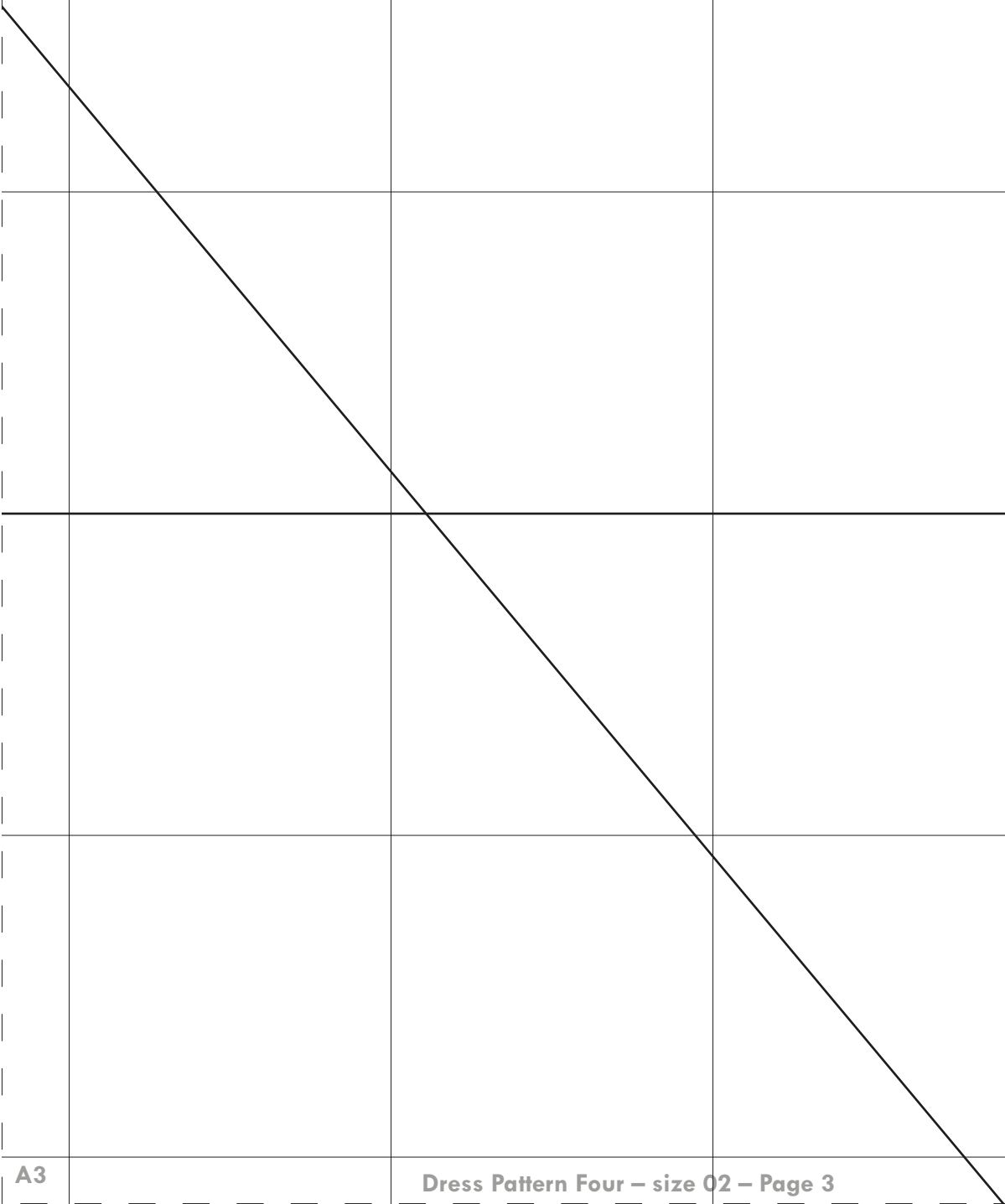

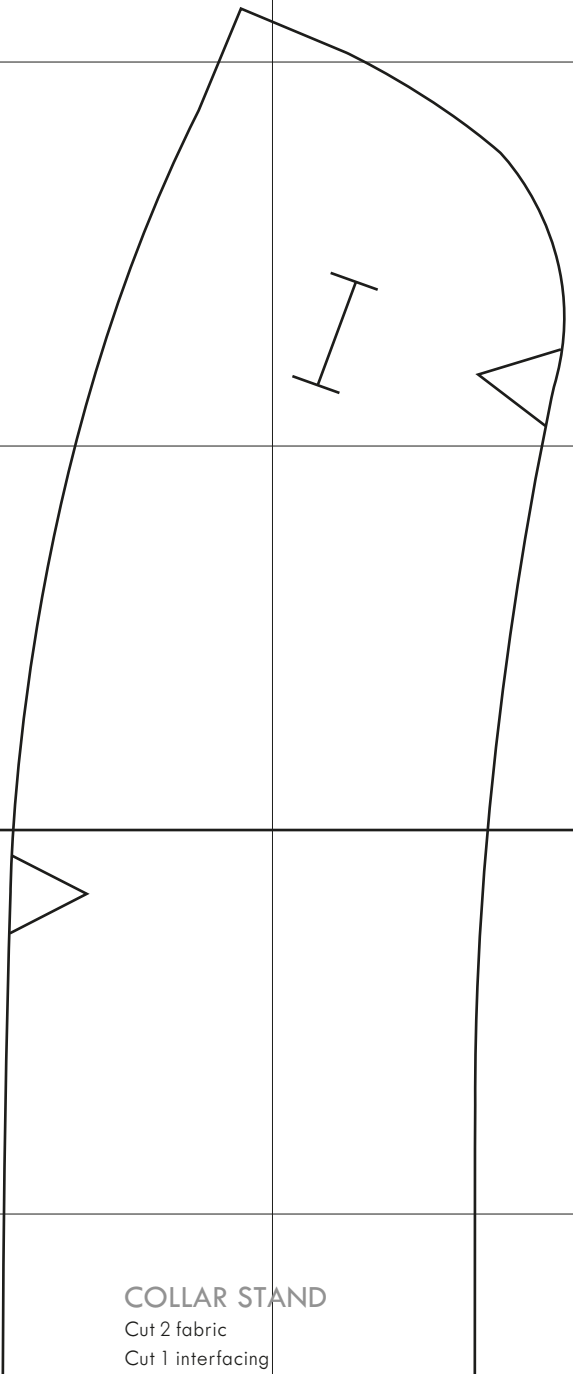

COLLAR STAND
Cut 2 fabric
Cut 1 interfacing

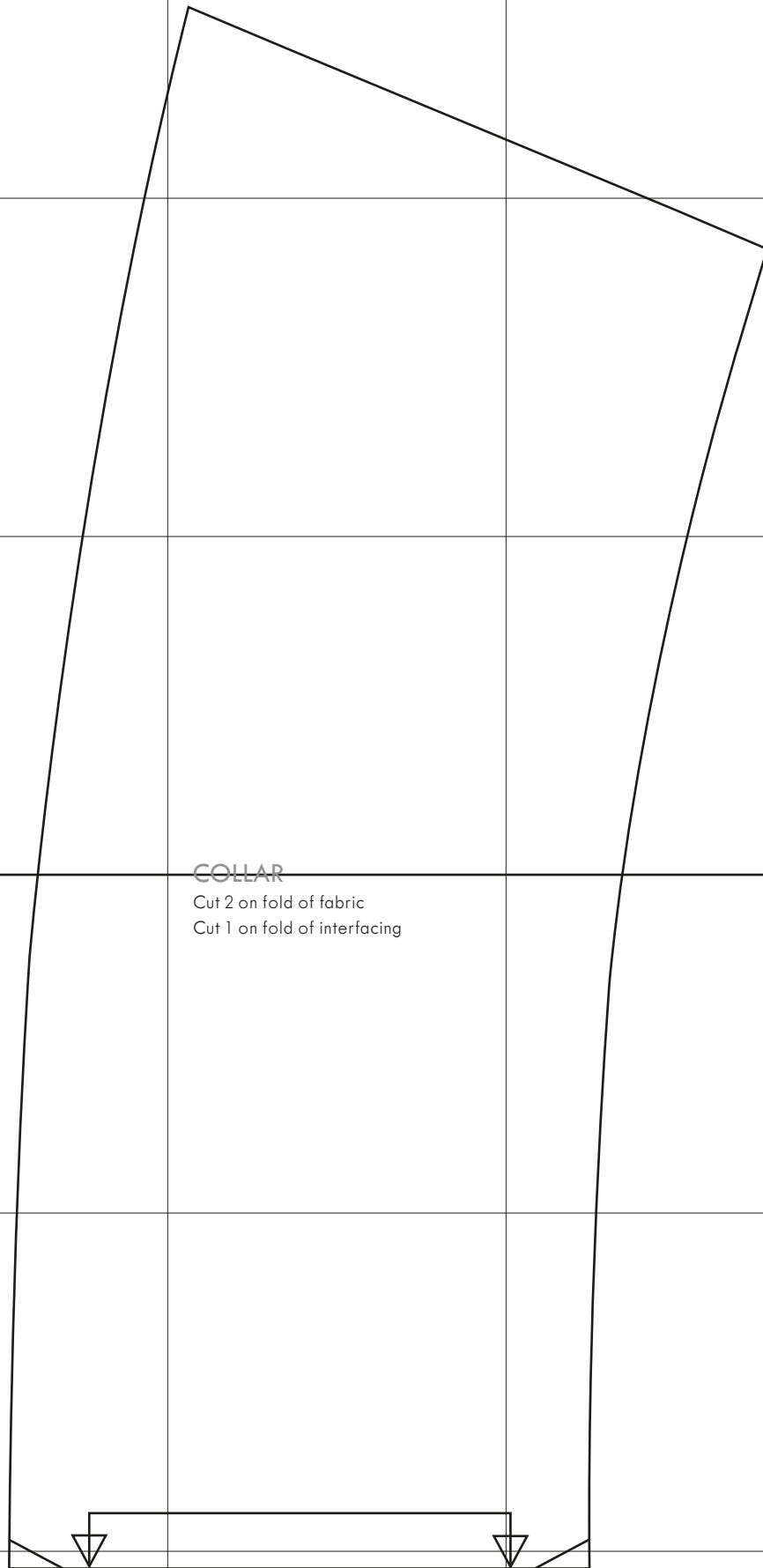

COLLAR

Cut 2 on fold of fabric
Cut 1 on fold of interfacing

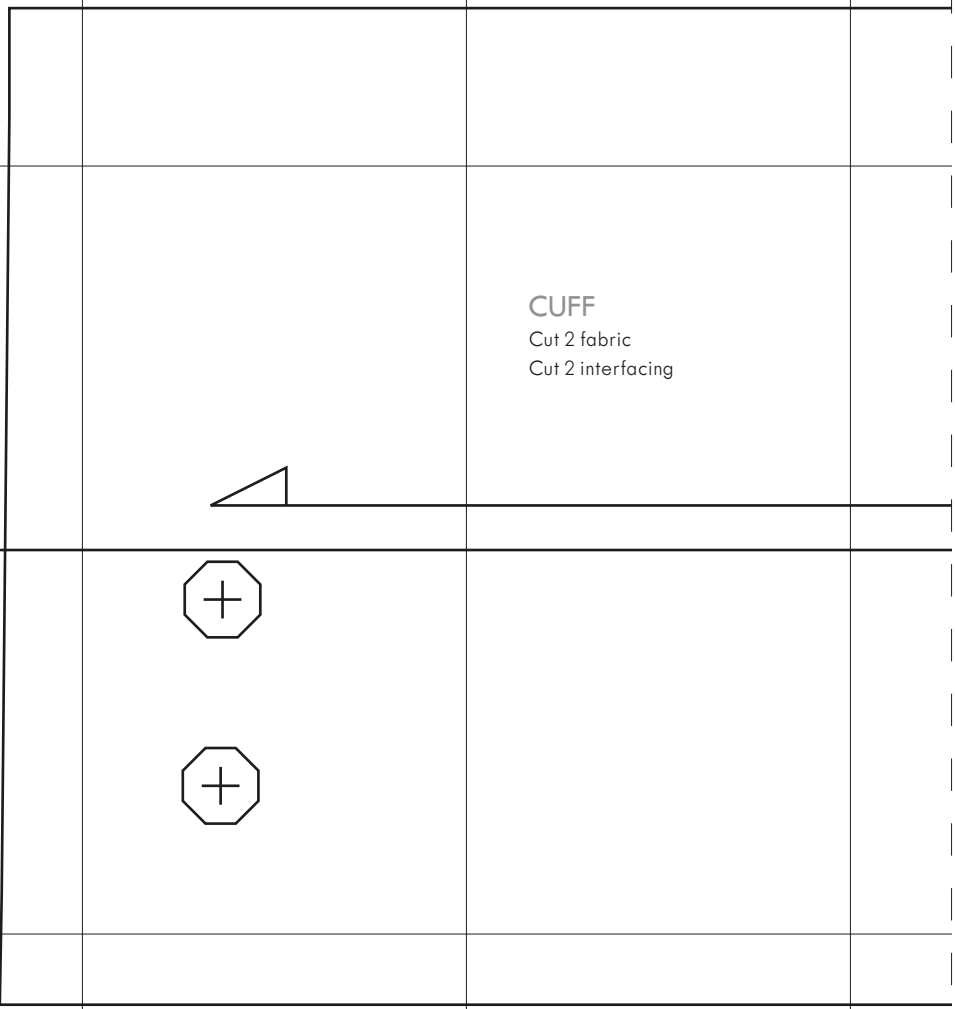

CUFF
Cut 2 fabric
Cut 2 interfacing

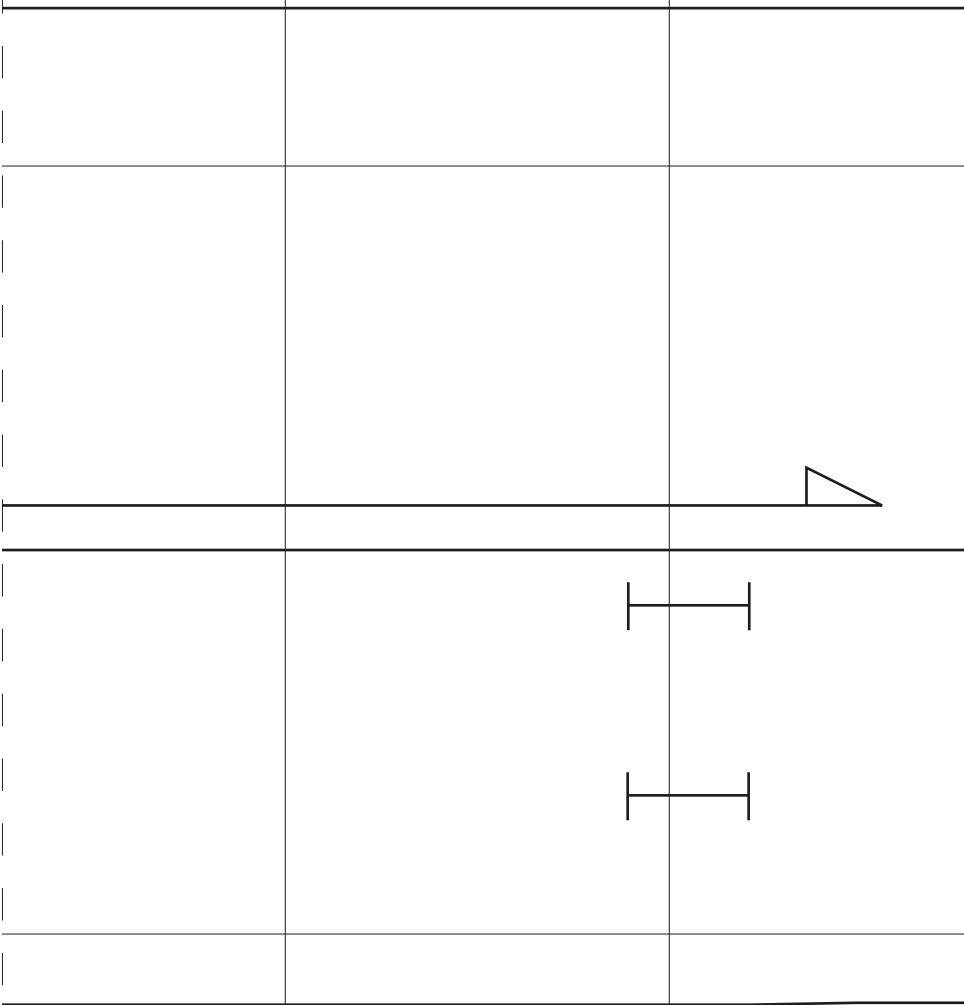

B1

B1

B1

B1

B2

B2

B2

B2

B3

B3

SKIRT FRONT
Cut 2 fabric

B3

B3

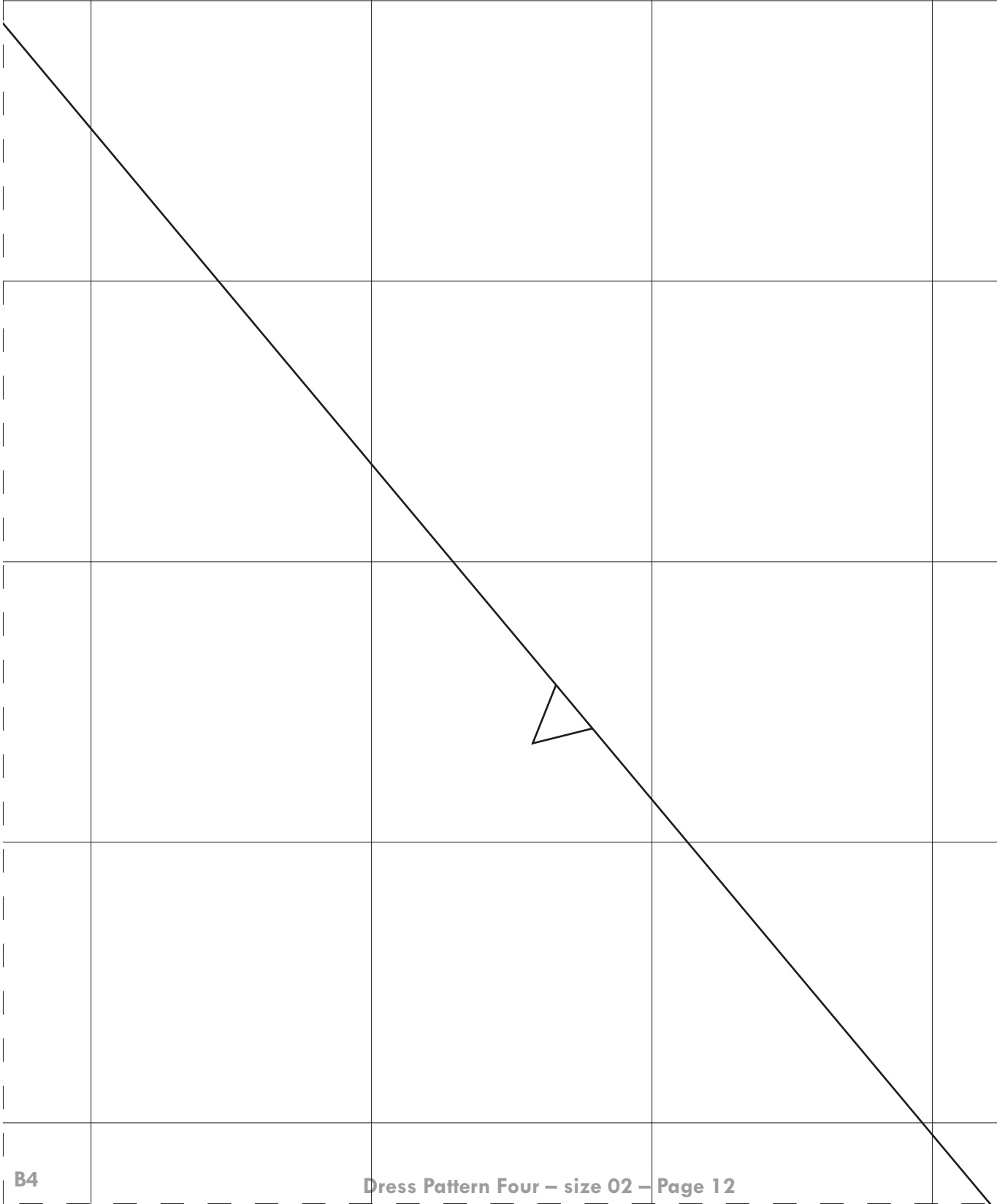

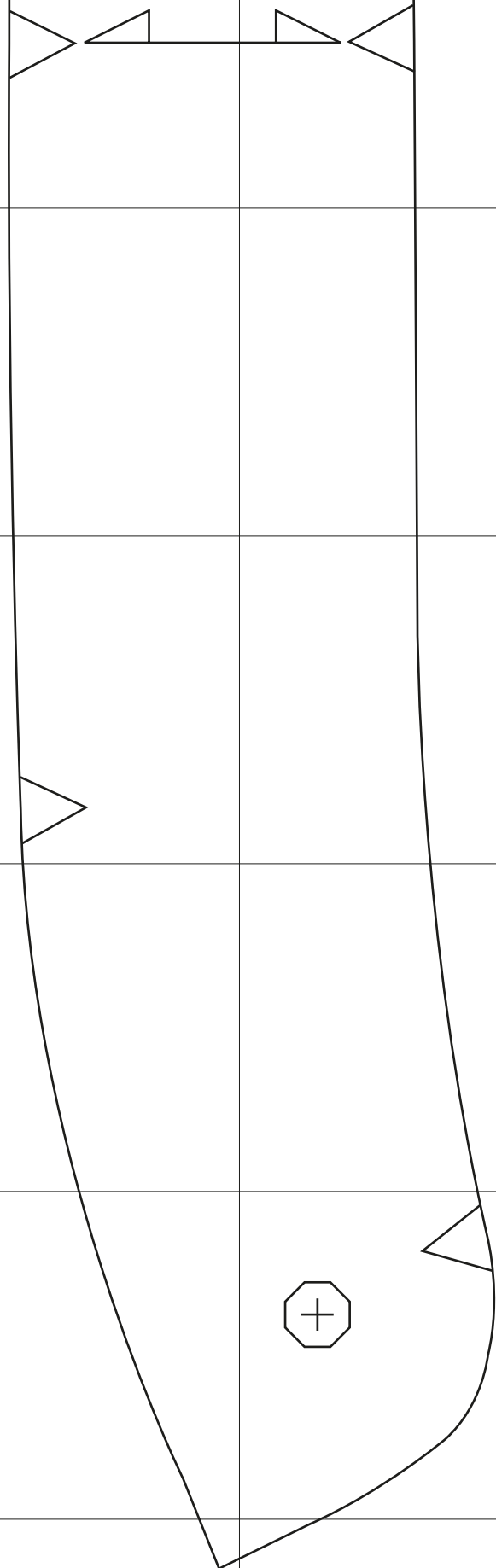

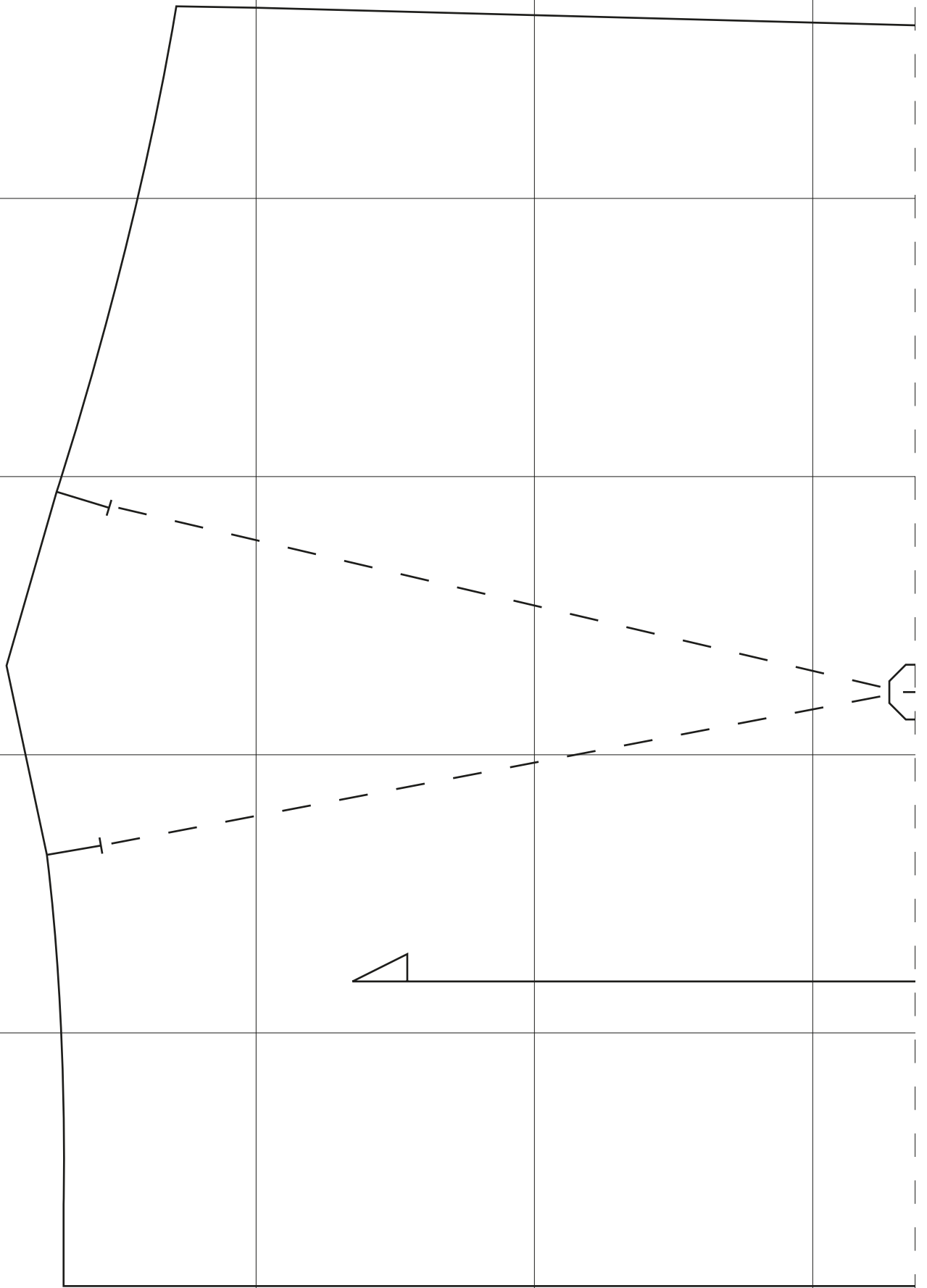

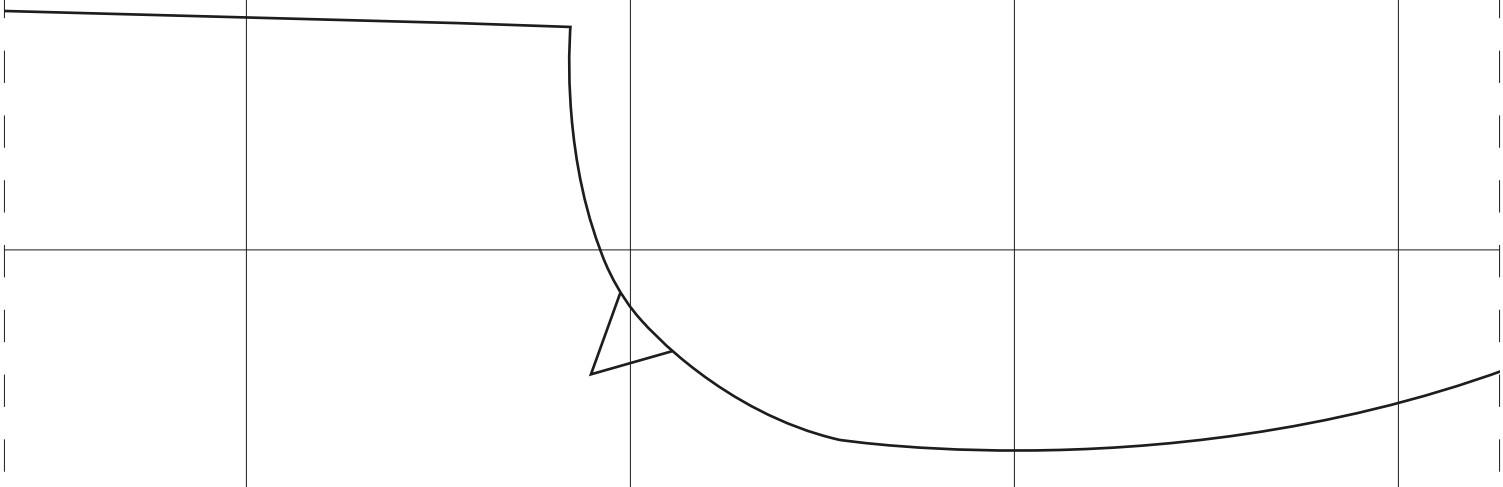

BODICE FRONT
Cut 2 in fabric

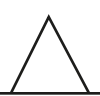

B8

B8

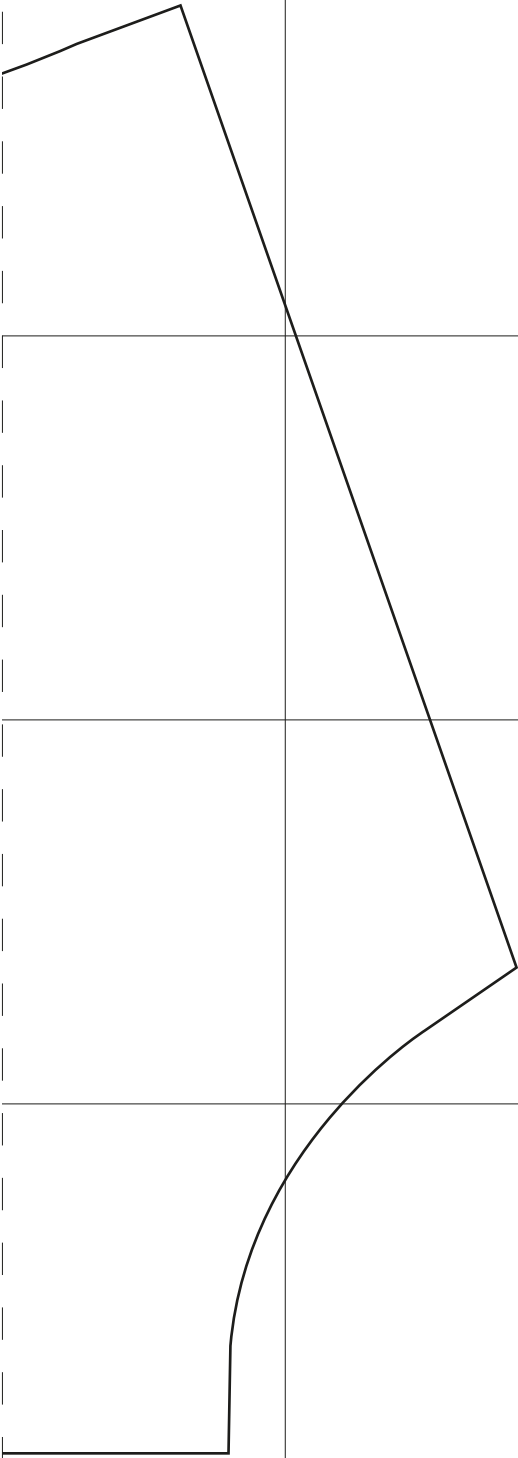

B8

B8

C1

C1

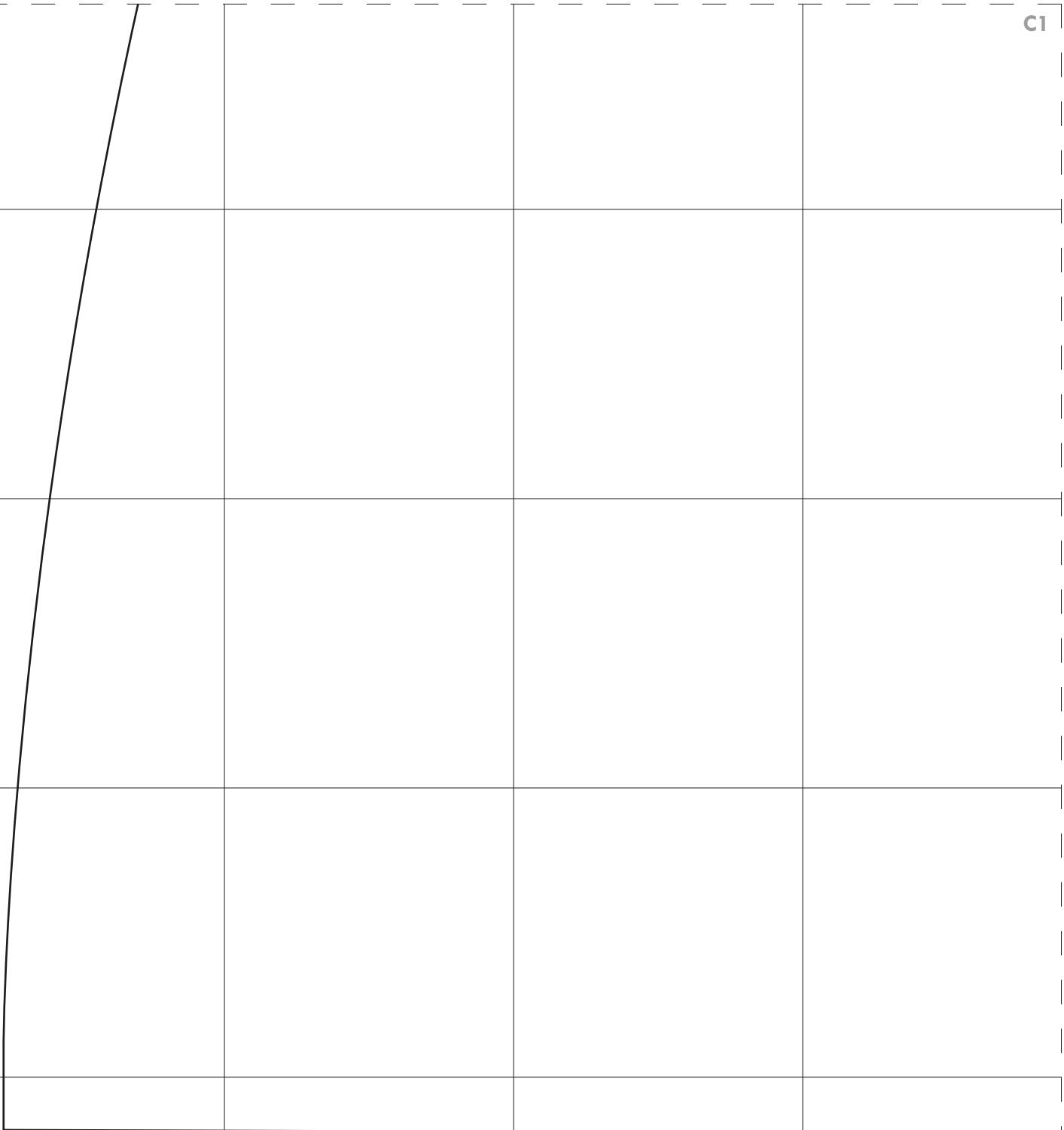

C1

C1

C2

C2

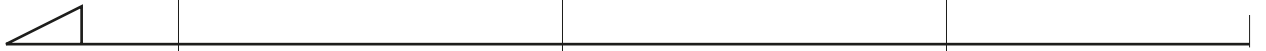

C2

C2

C3

C3



C3

C3

C4

C4

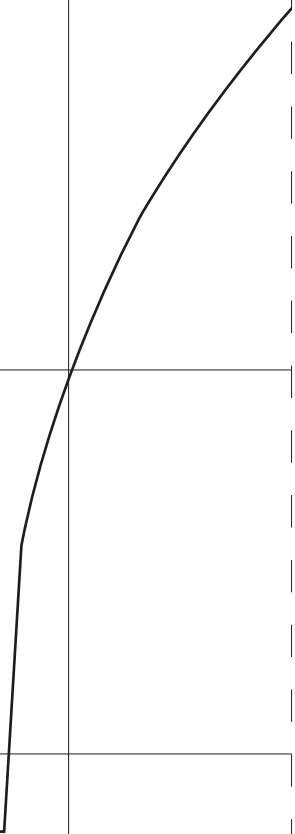
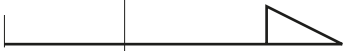

C4

C4

C5

C5

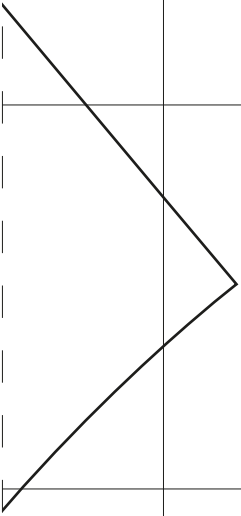

C5

C5

C6

C6

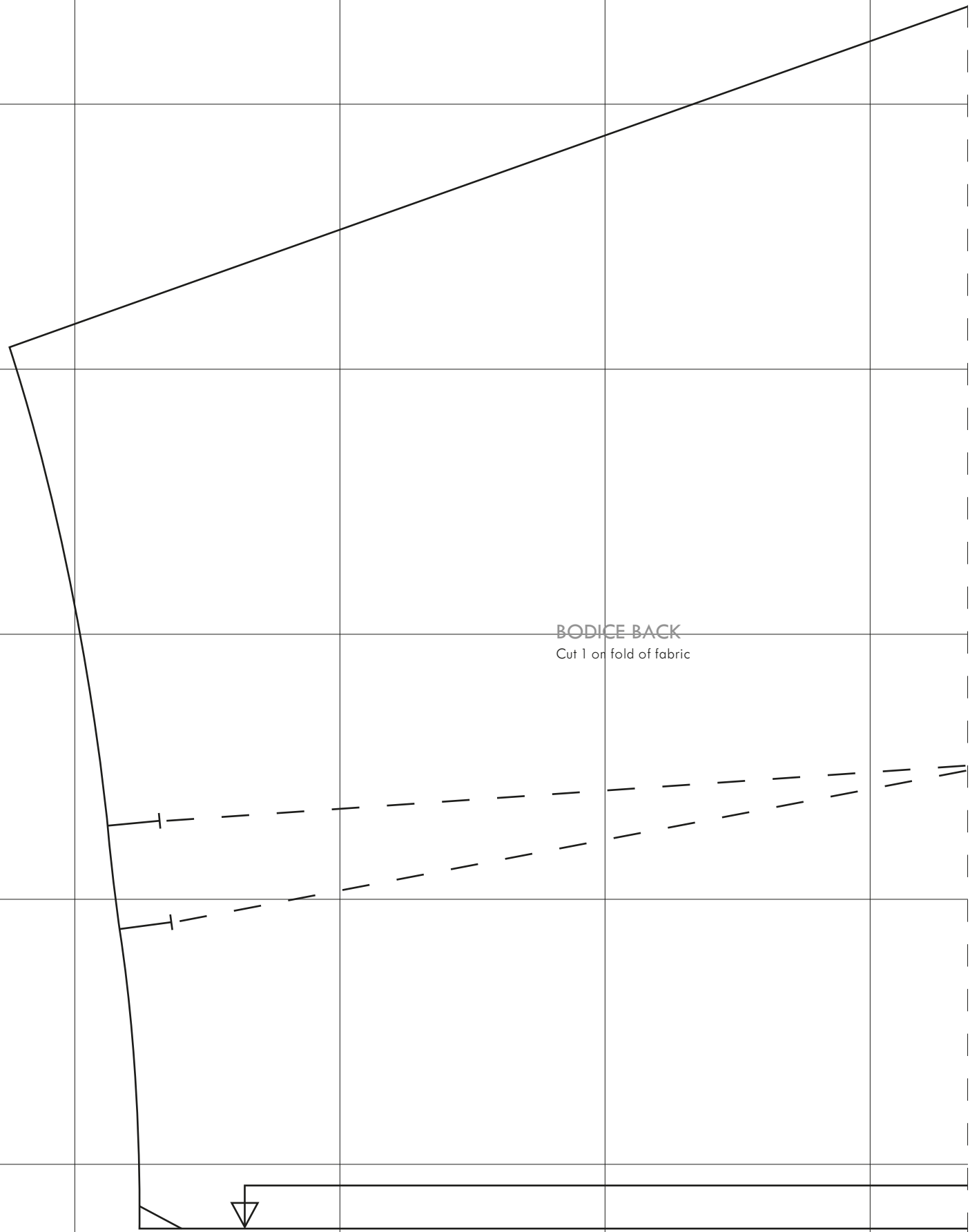

BODICE BACK
Cut 1 on fold of fabric

C6

C6

C7

C7

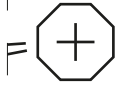
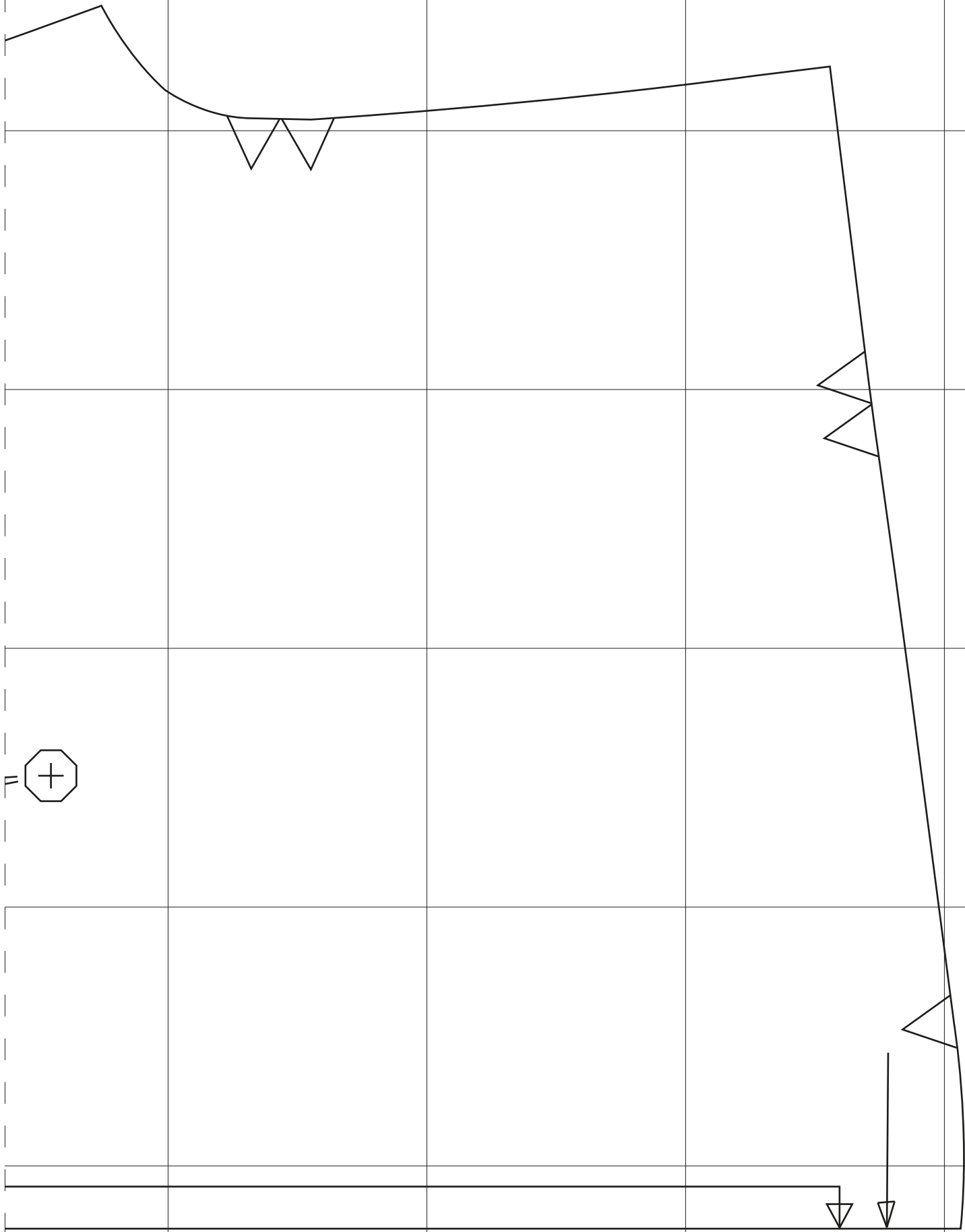

C7

C7

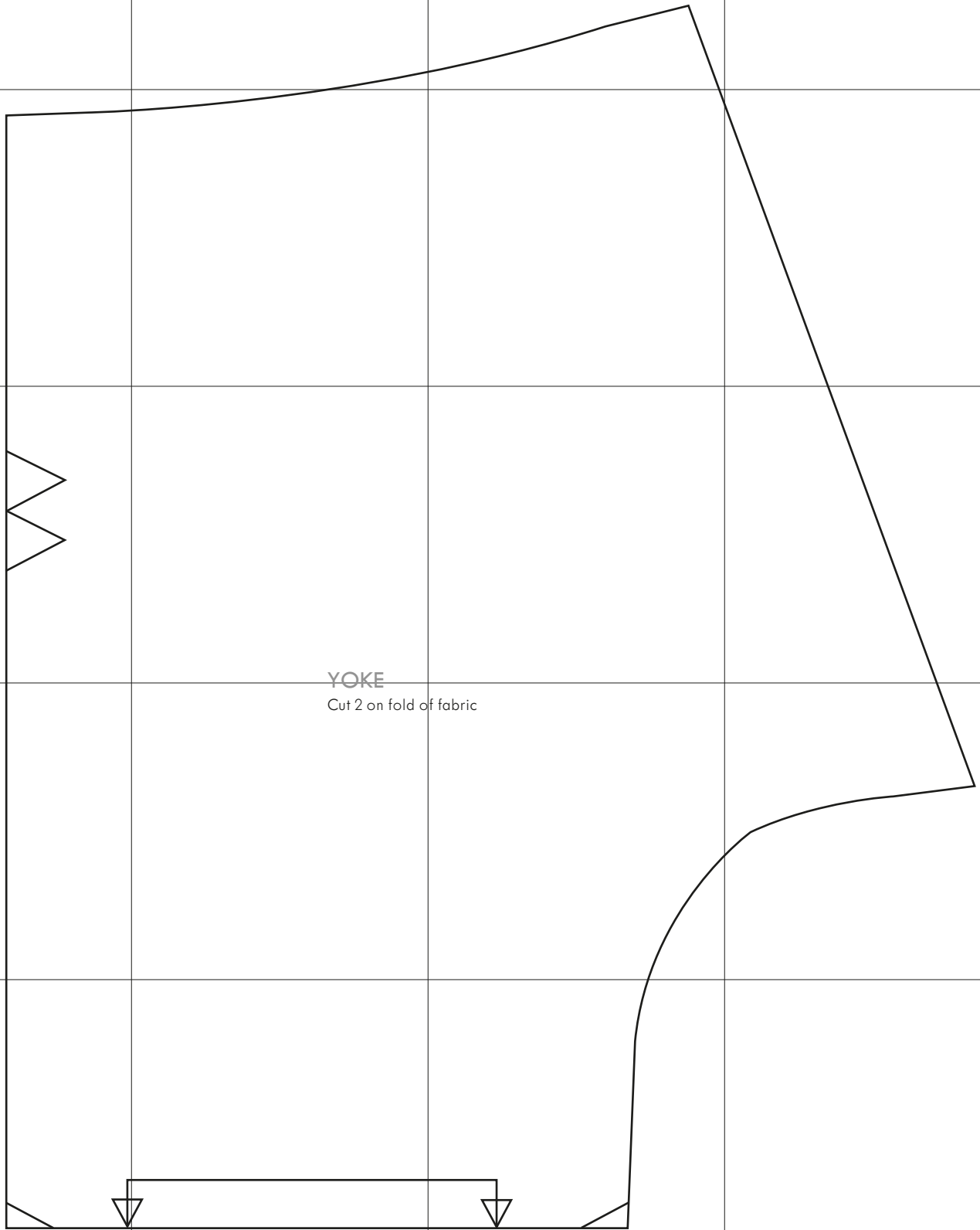

YOKE
Cut 2 on fold of fabric

D1

D1

D1

D1

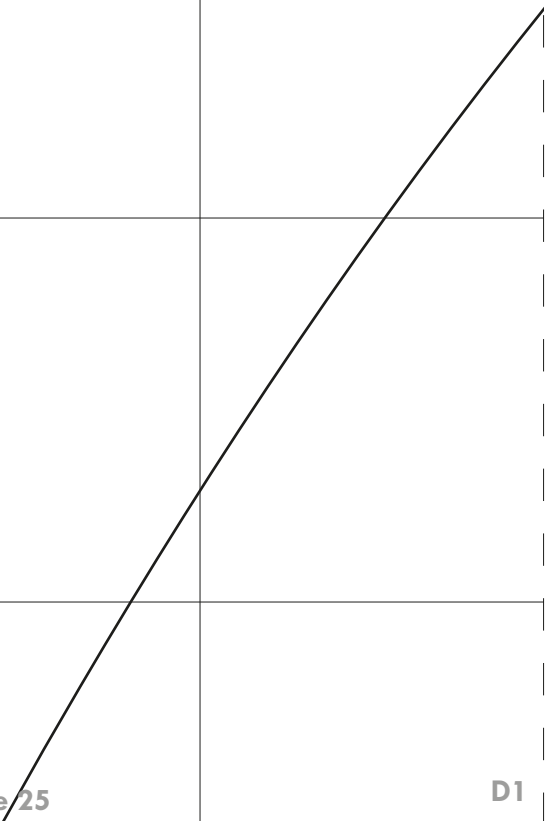

D2

D2

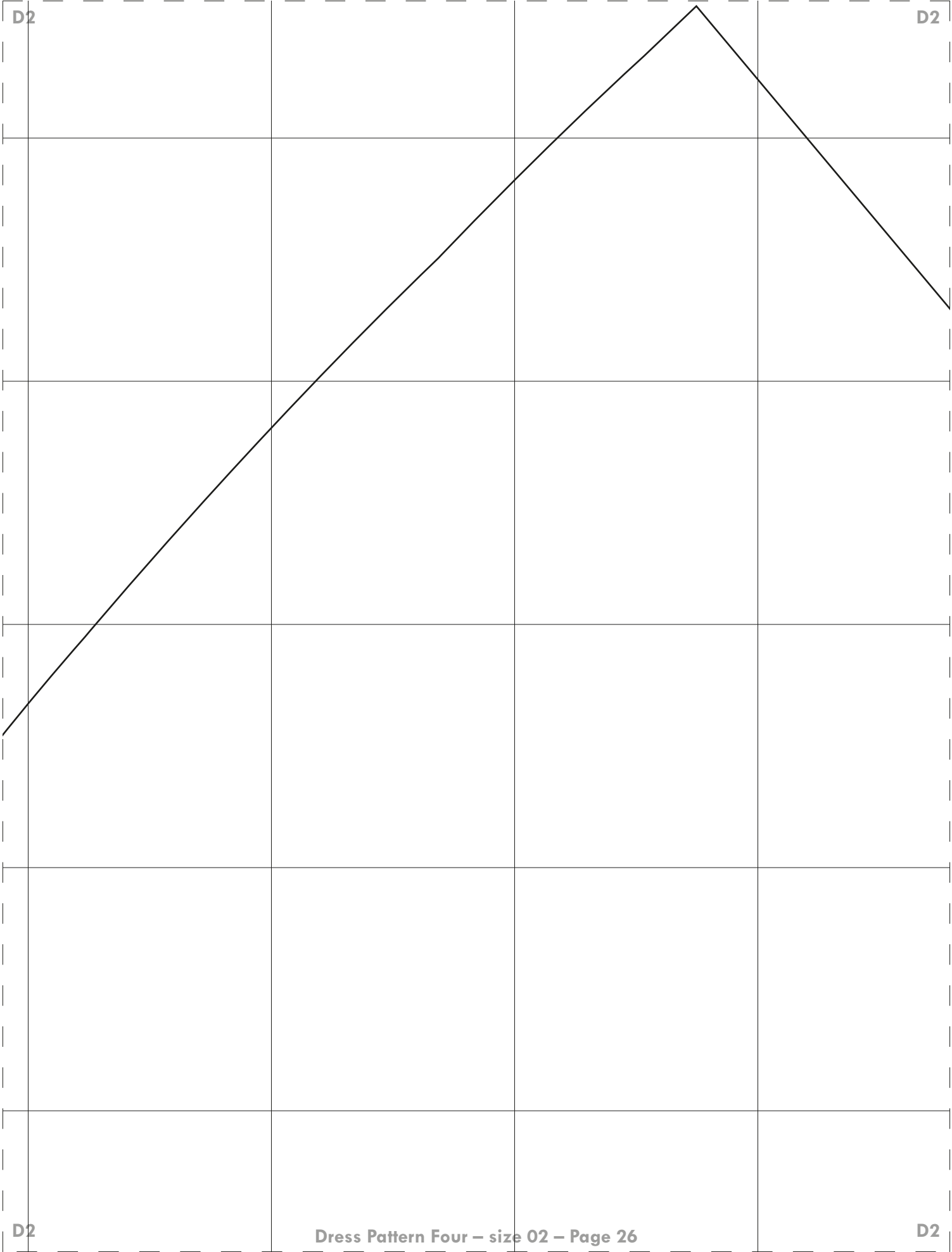

D2

D2

D3

D3

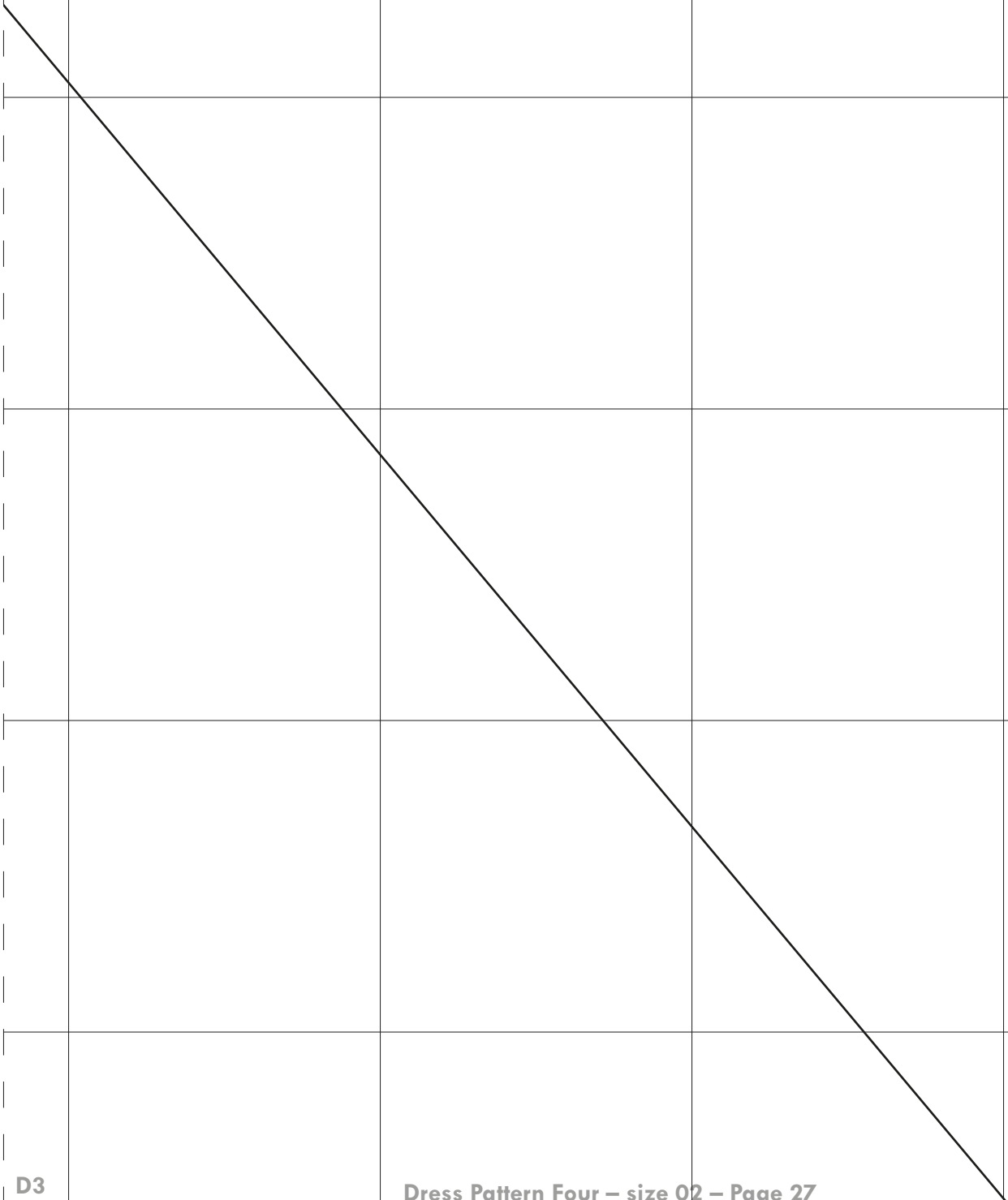

D3

D3

D4

D4

D4

D4

D5

D5

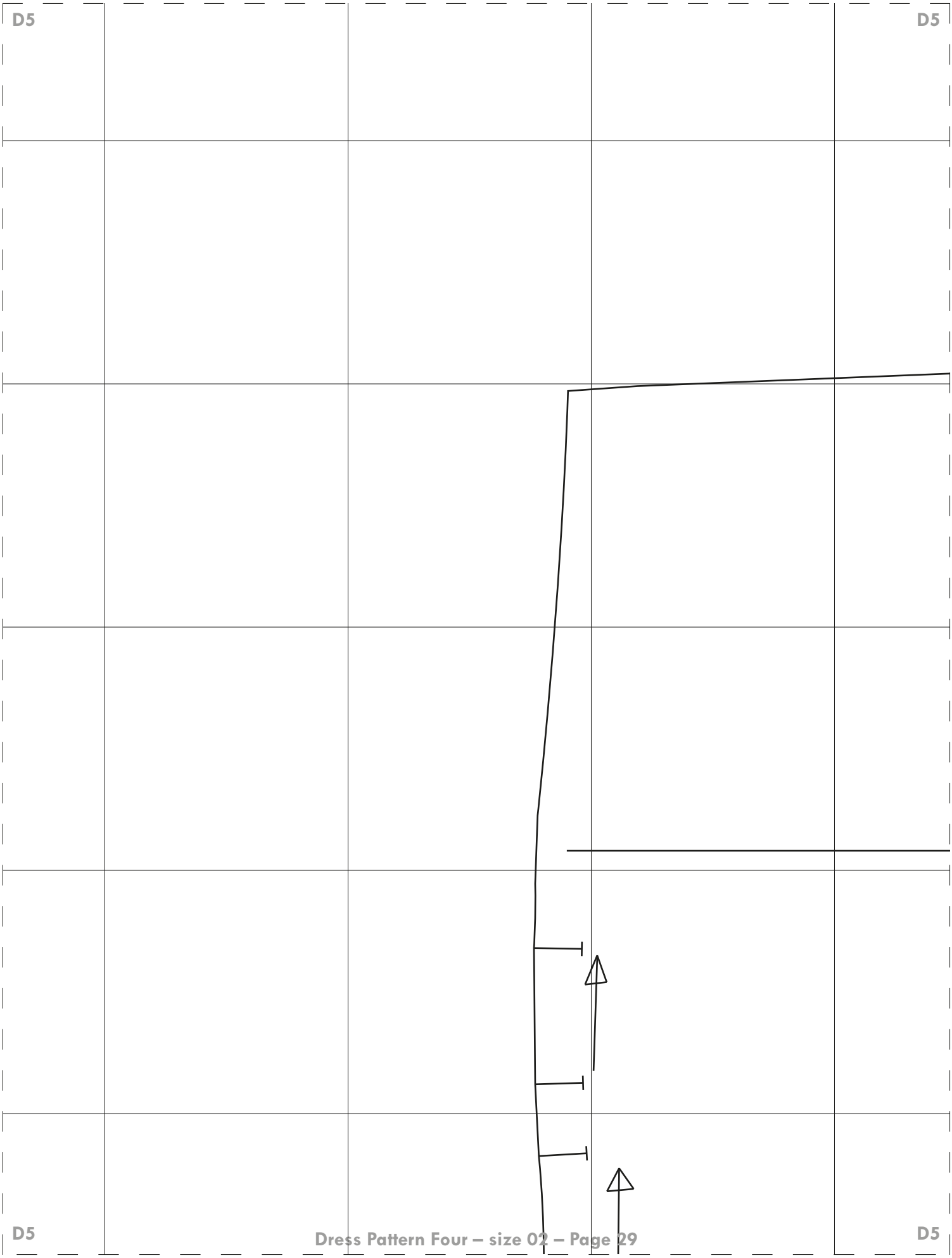

D5

D5

D6

D6

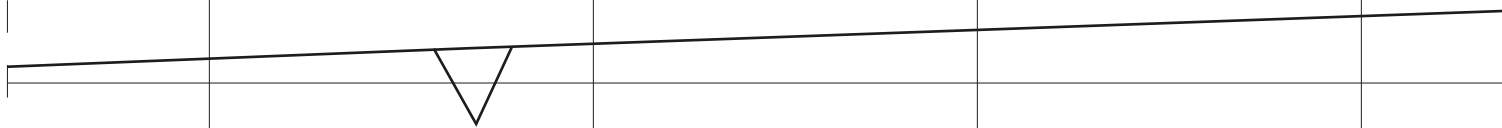

D6

D6

D7

D7

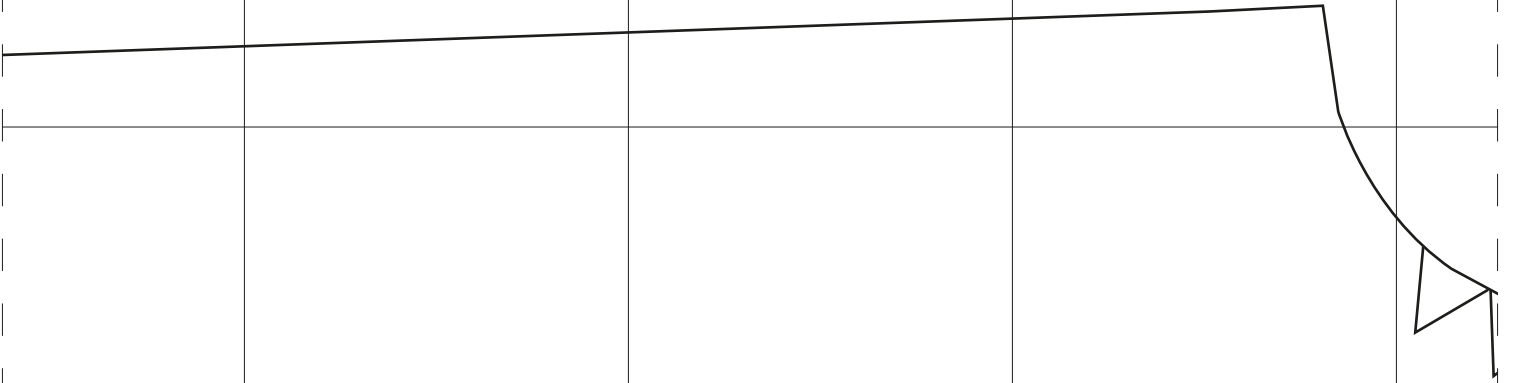

SLEEVE
Cut 2 fabric

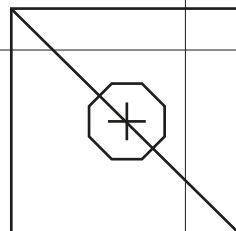
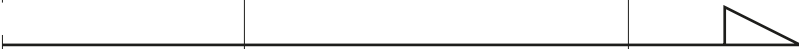

D7

D7

D8

D8

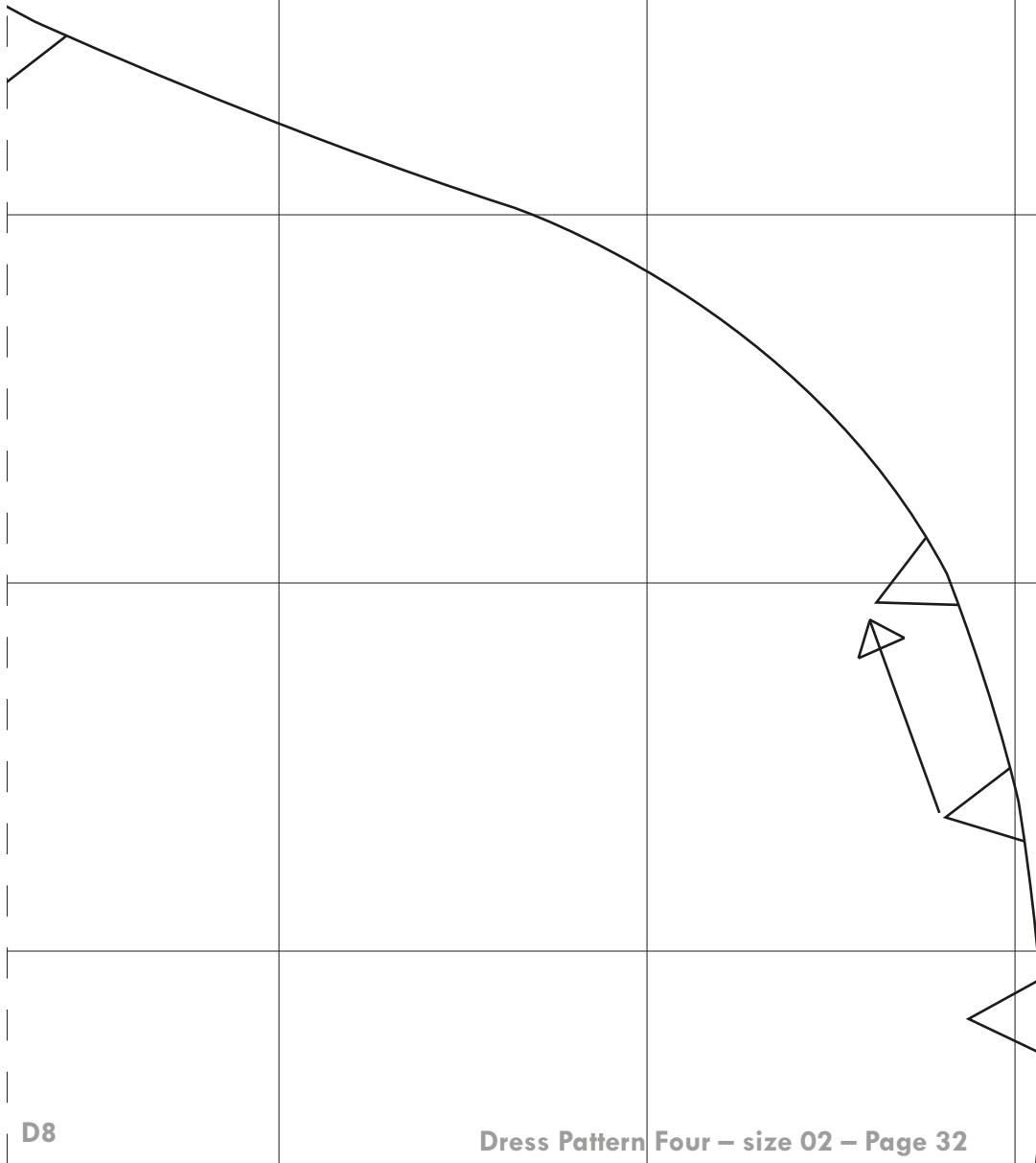

D8

D8

E1

E1

E1

E1

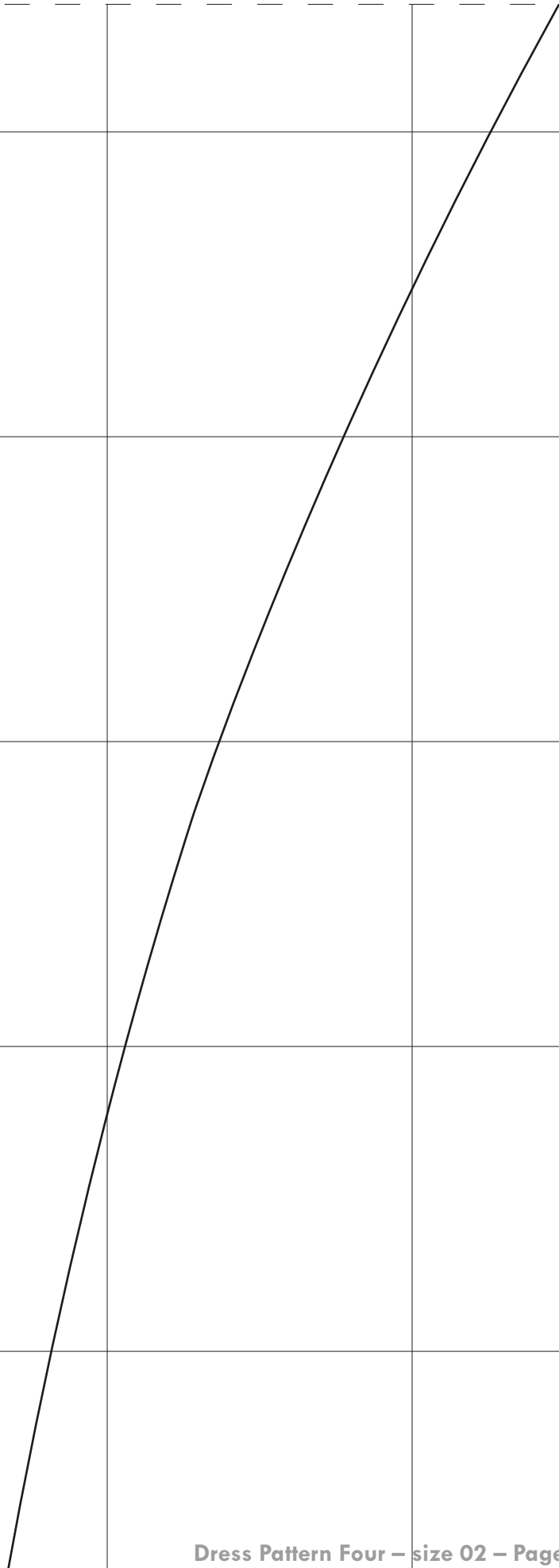

E2

E2

E2

E2

E3

E3

SKIRT BACK
Cut 1 on fold of fabric

E3

E3

E4

E4

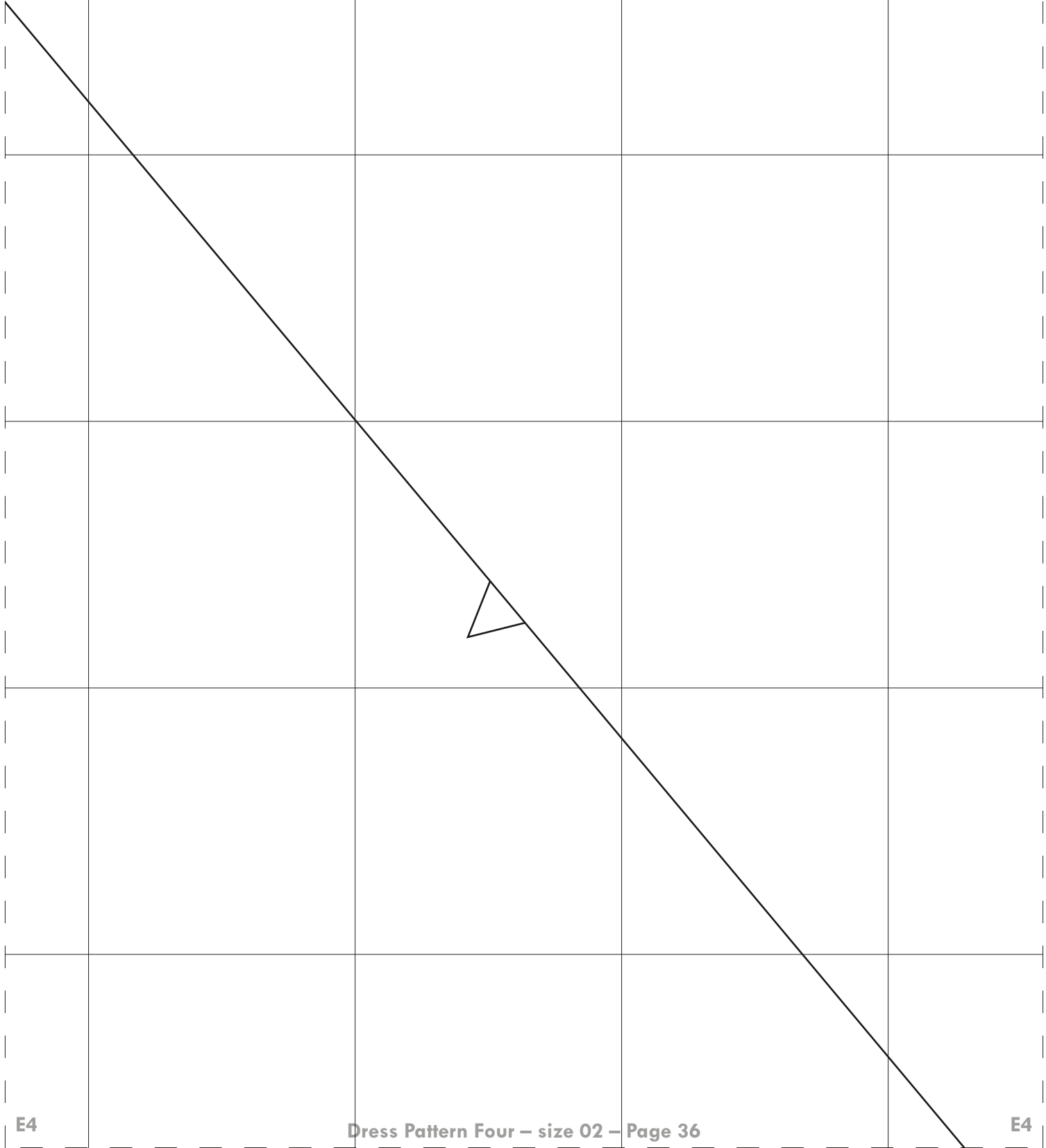

E4

E4

E5

E5

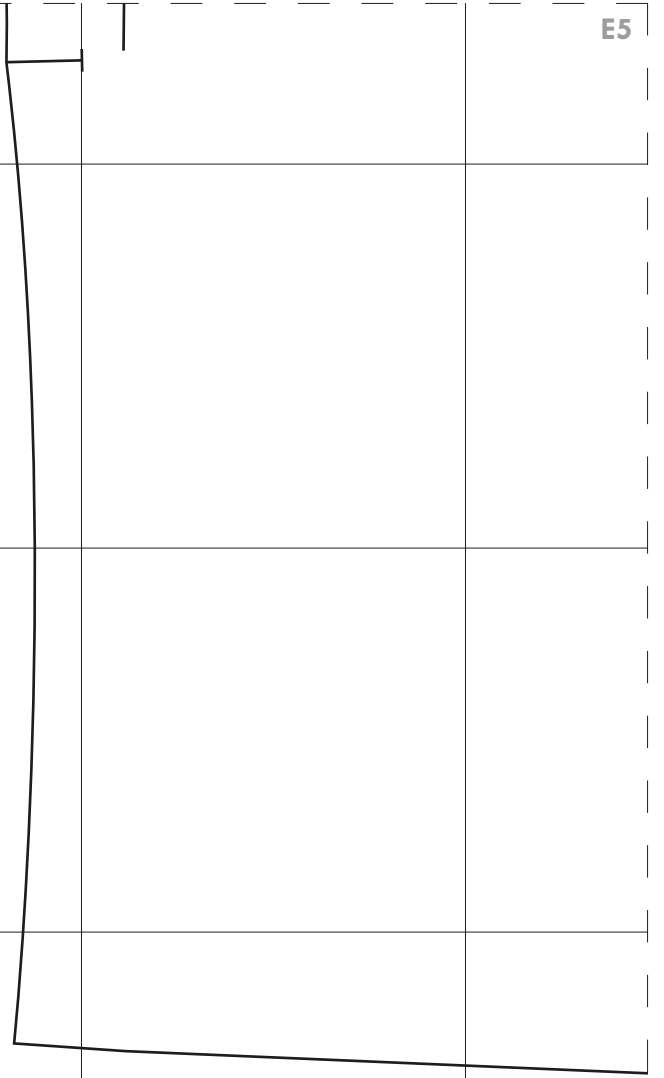

E5

E5

E6

E6



E6

E6

E7

E7



E7

E7

E8

E8

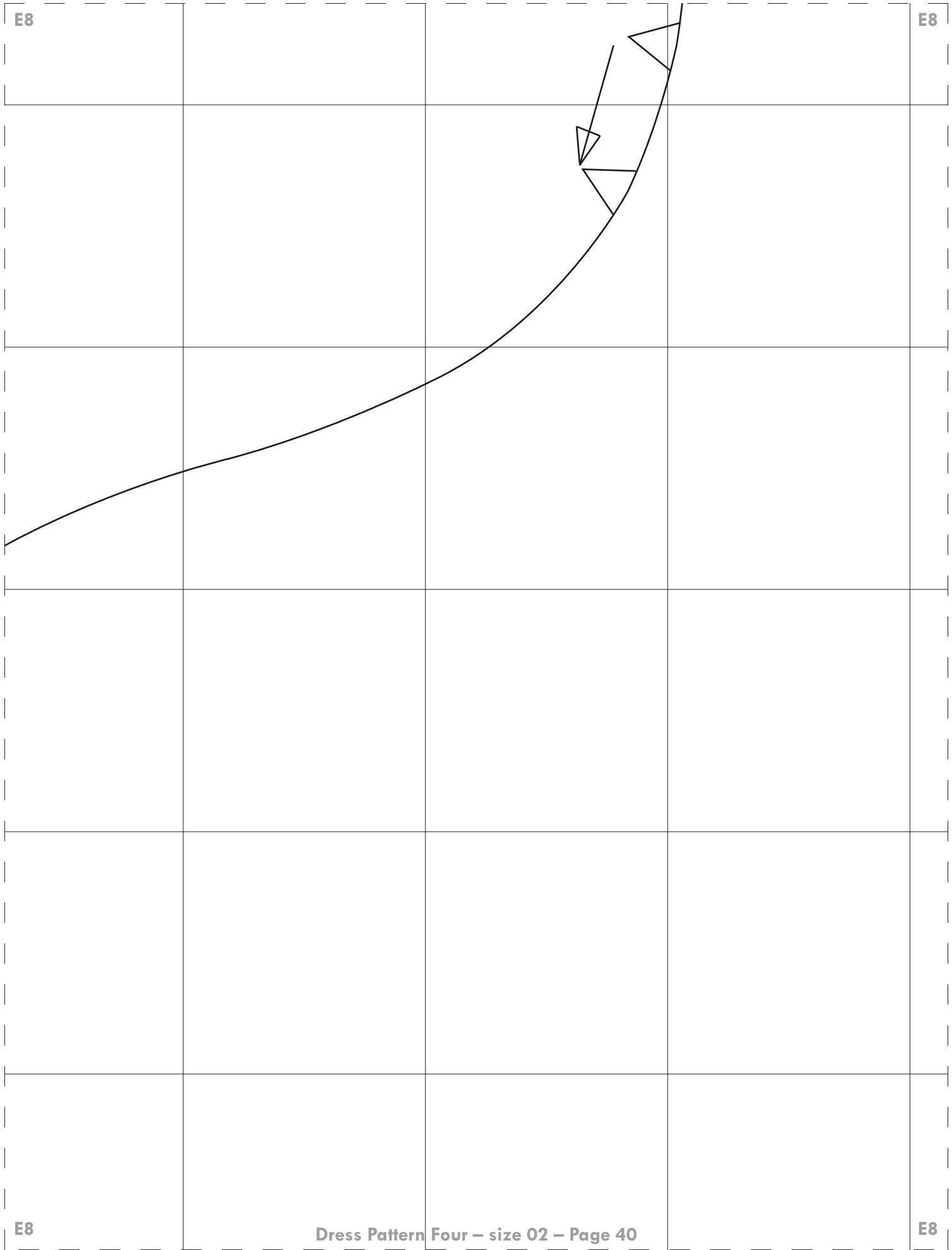

E8

E8

F1

F1

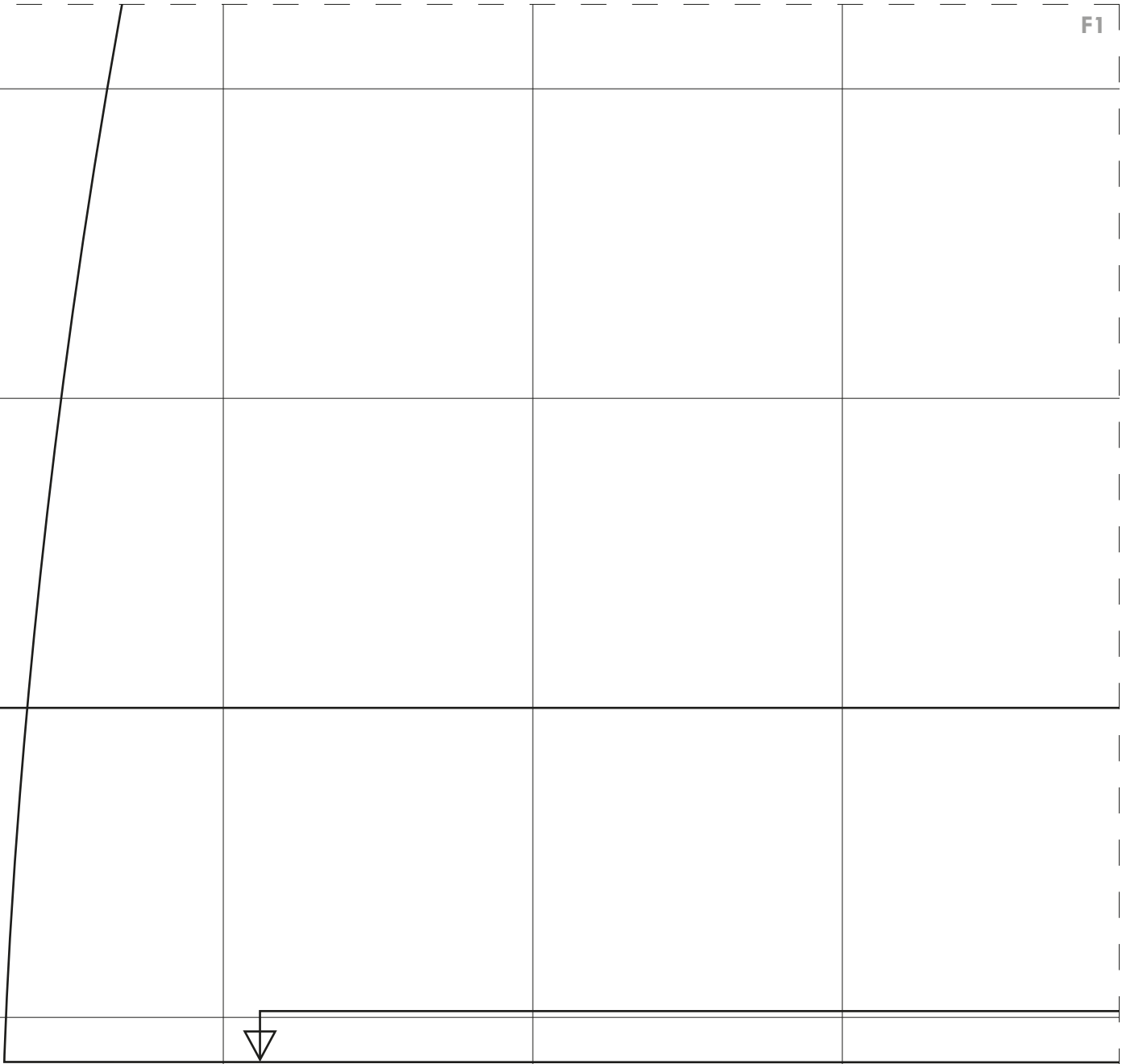

F1

F1

F2

F2

F2

F2

F3

F3

F3

F3

F4

F4

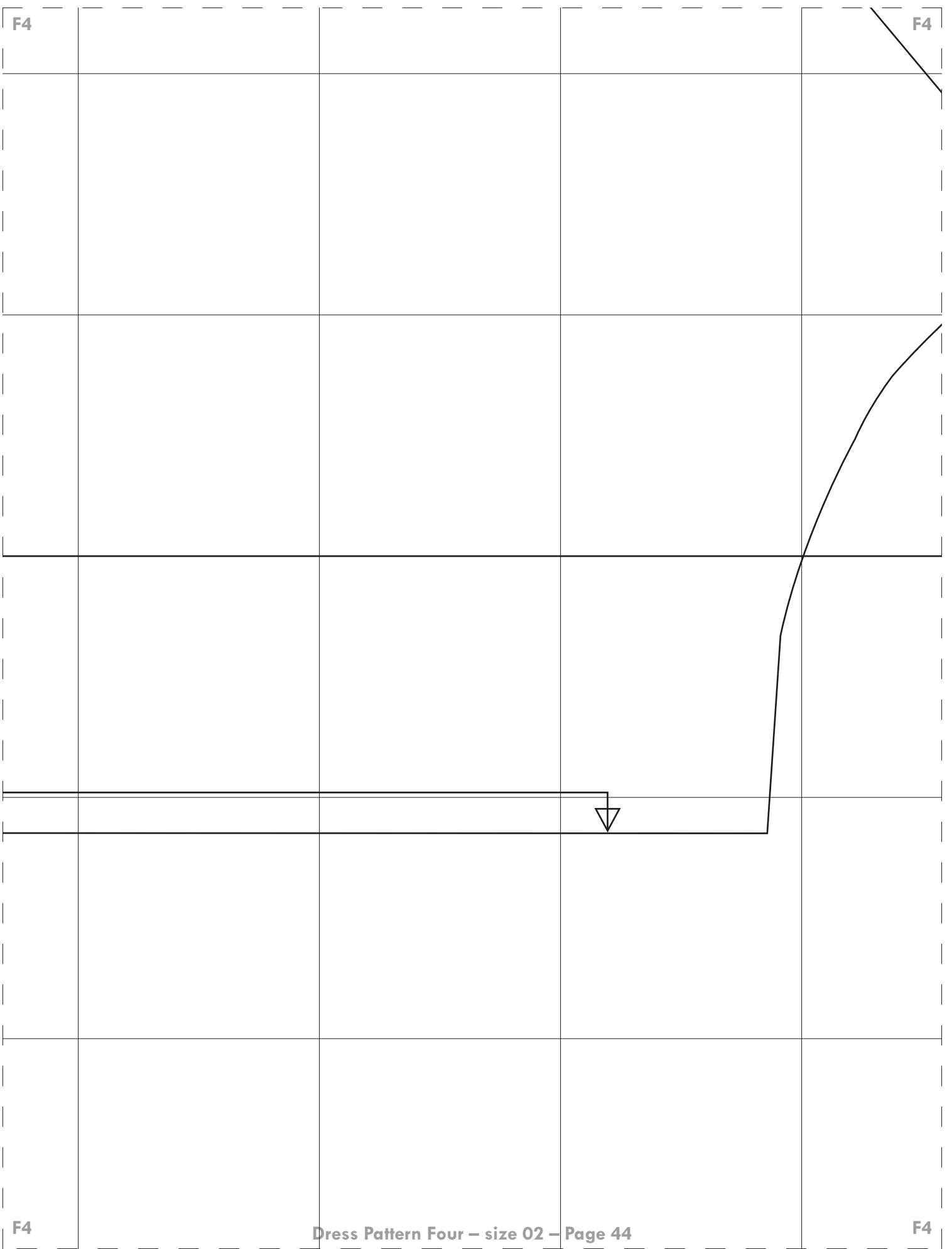

F4

F4

F5

F5

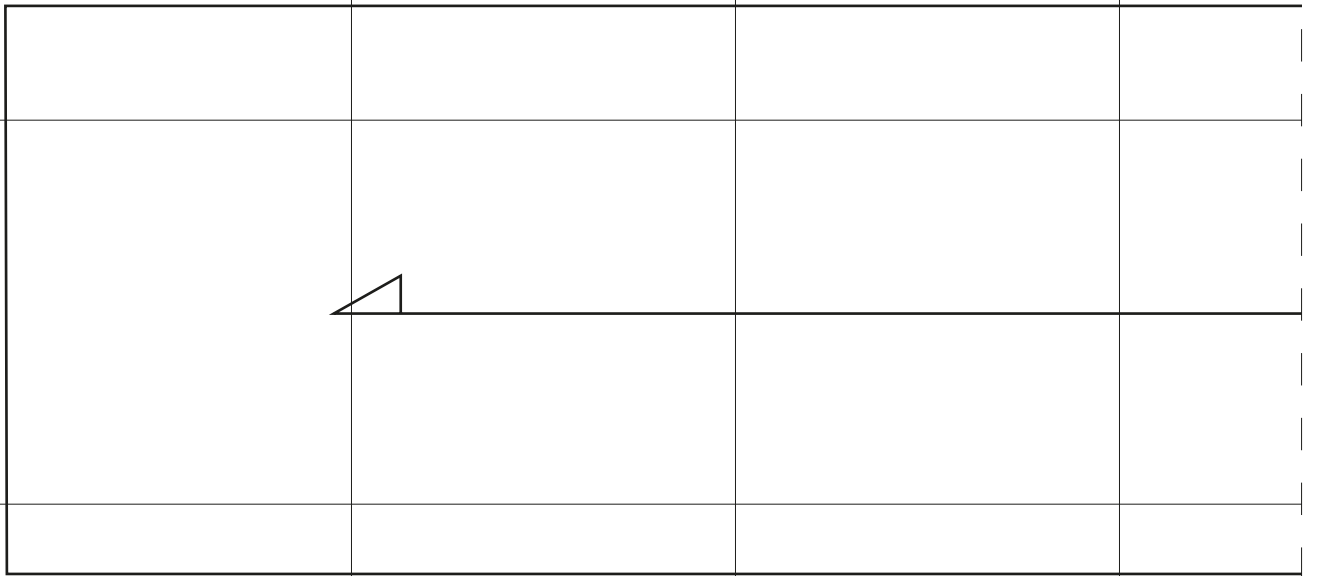
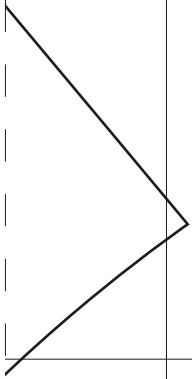

SLEEVE TAB FOR VARIATION

Cut 2 fabric

Cut 2 interfacing

F5

F5

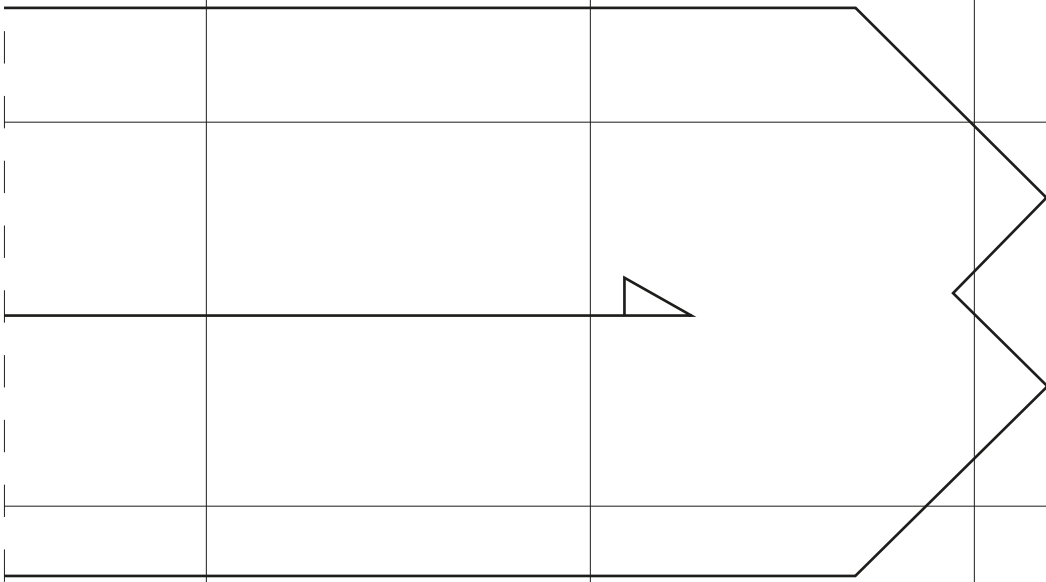

F7

F7

SLEEVE OPENING BINDING
Cut 2 fabric



F7

F7

F8

F8

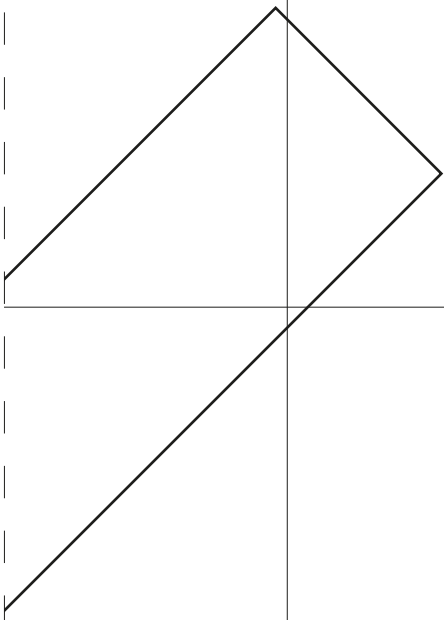

F8

F8

G1

G1

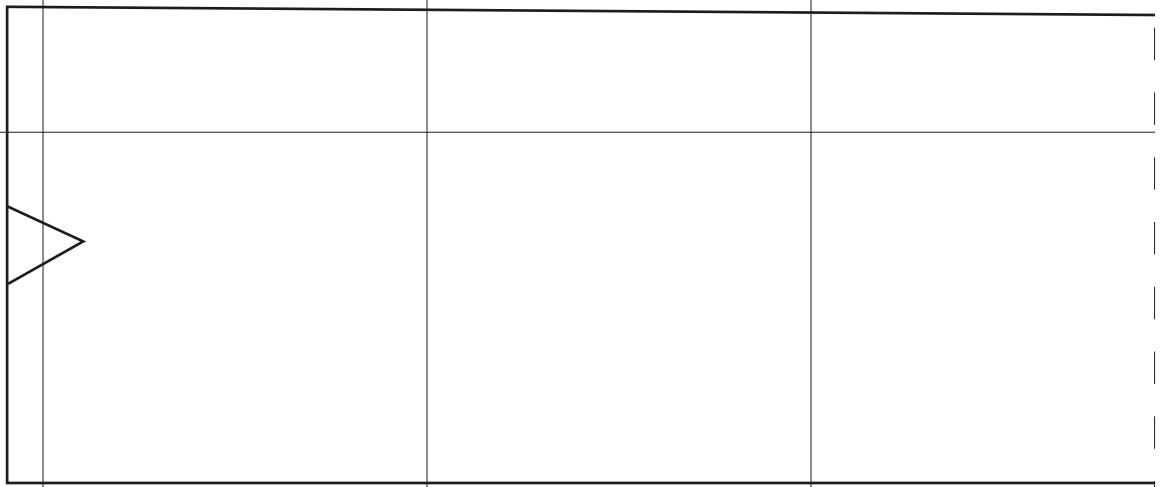

G1

G1

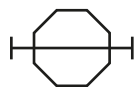
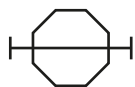

G3

G3

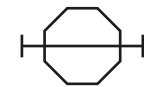

G3

G3

FRONT BUTTON PLACKET

Cut 4 fabric
Cut 2 interfacing

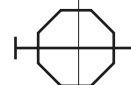
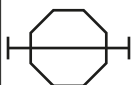

G5

G5

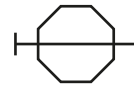
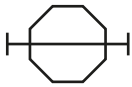

G5

G5

