

A1

A1

A1

A1

A2

A2

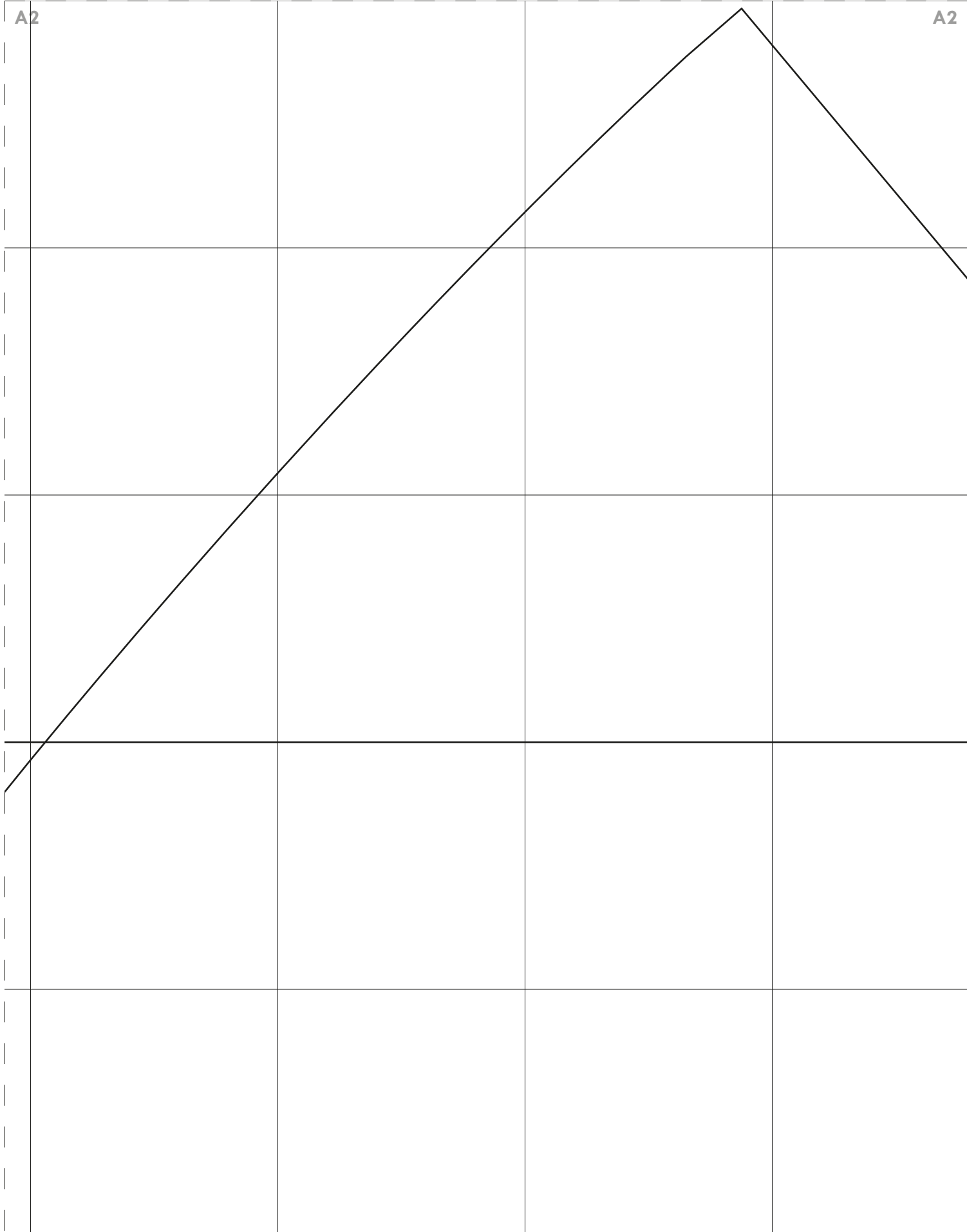

A2

A2

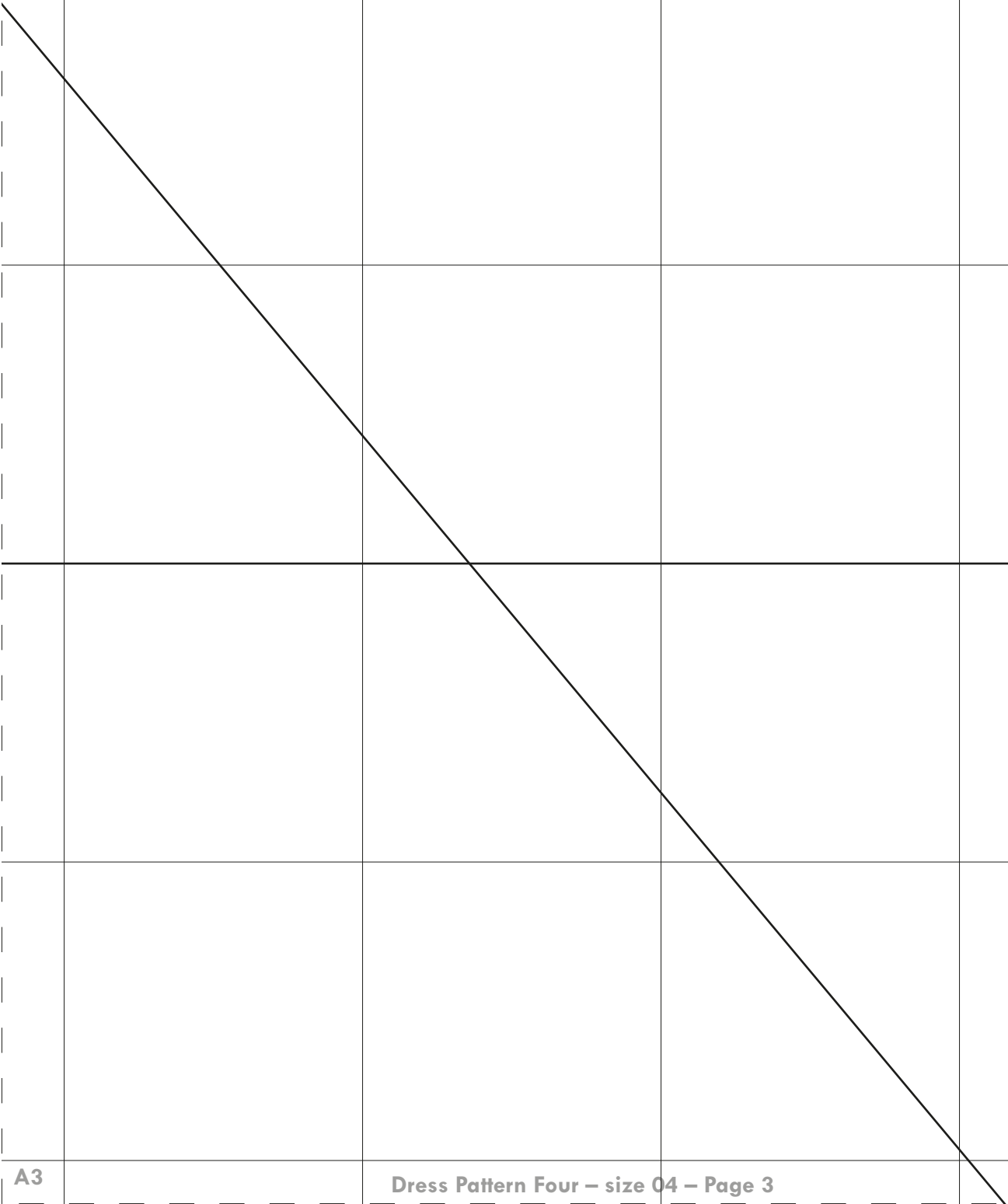



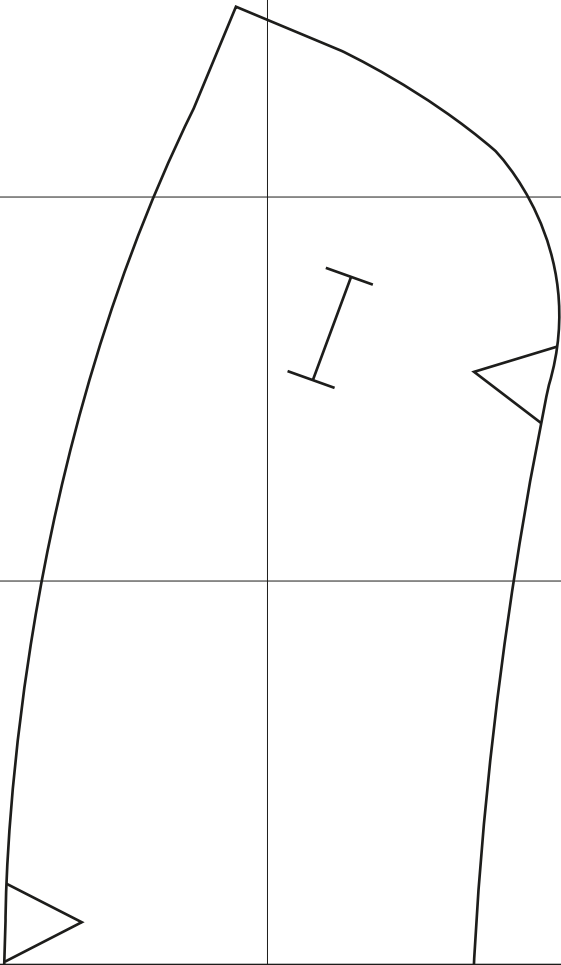

COLLAR STAND  
Cut 2 fabric  
Cut 1 interfacing

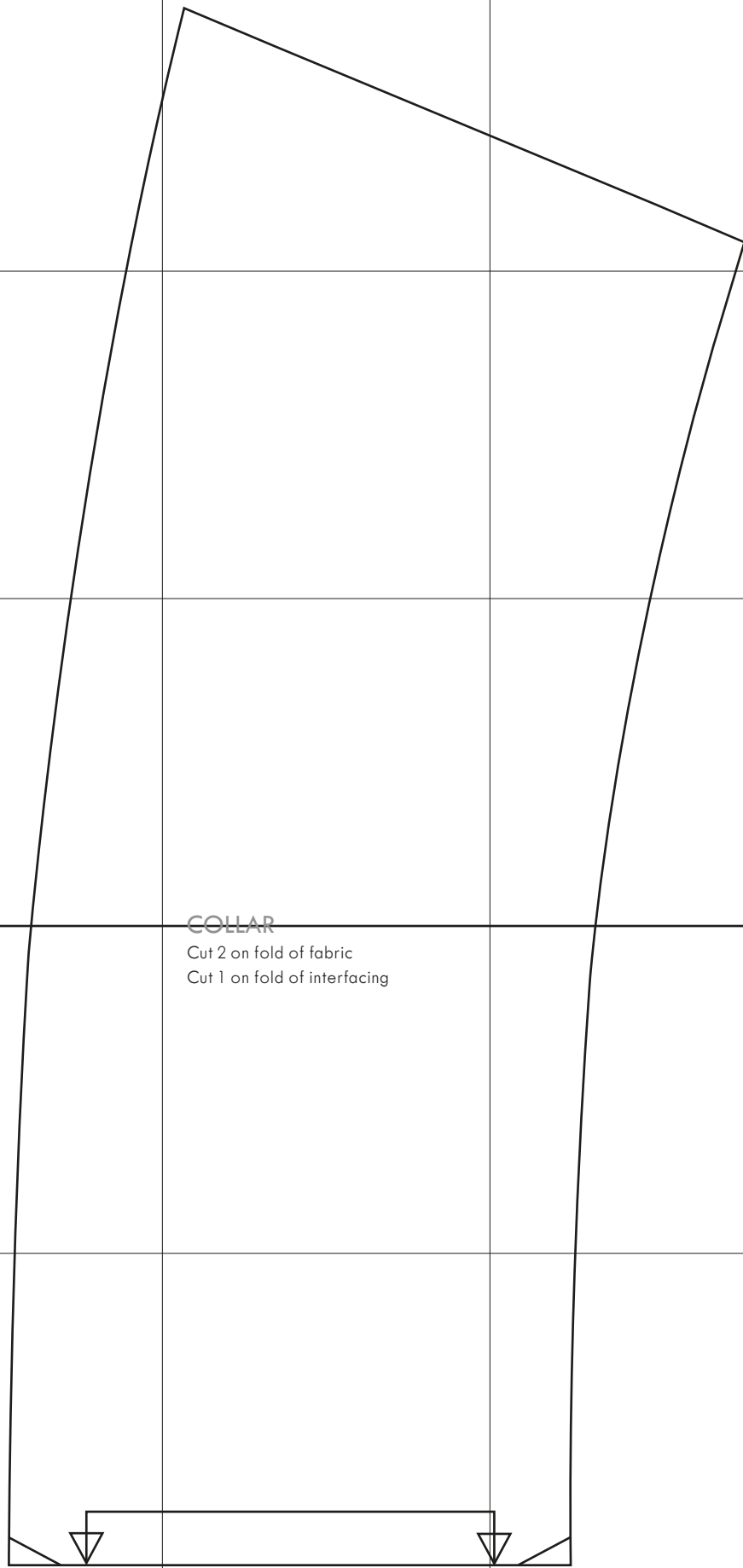

**COLLAR**

Cut 2 on fold of fabric  
Cut 1 on fold of interfacing

CUFF  
 Cut 2 fabric  
 Cut 2 interfacing



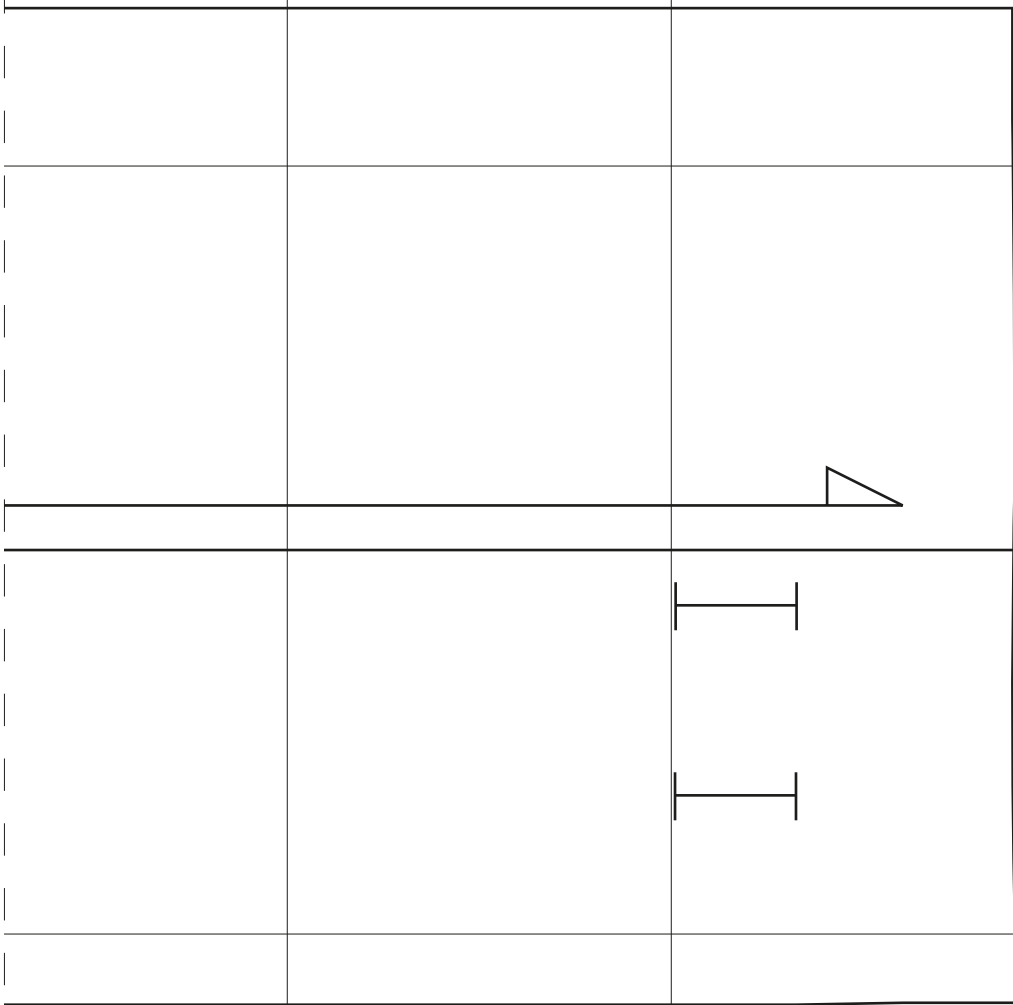



B1

B1

B1

B1

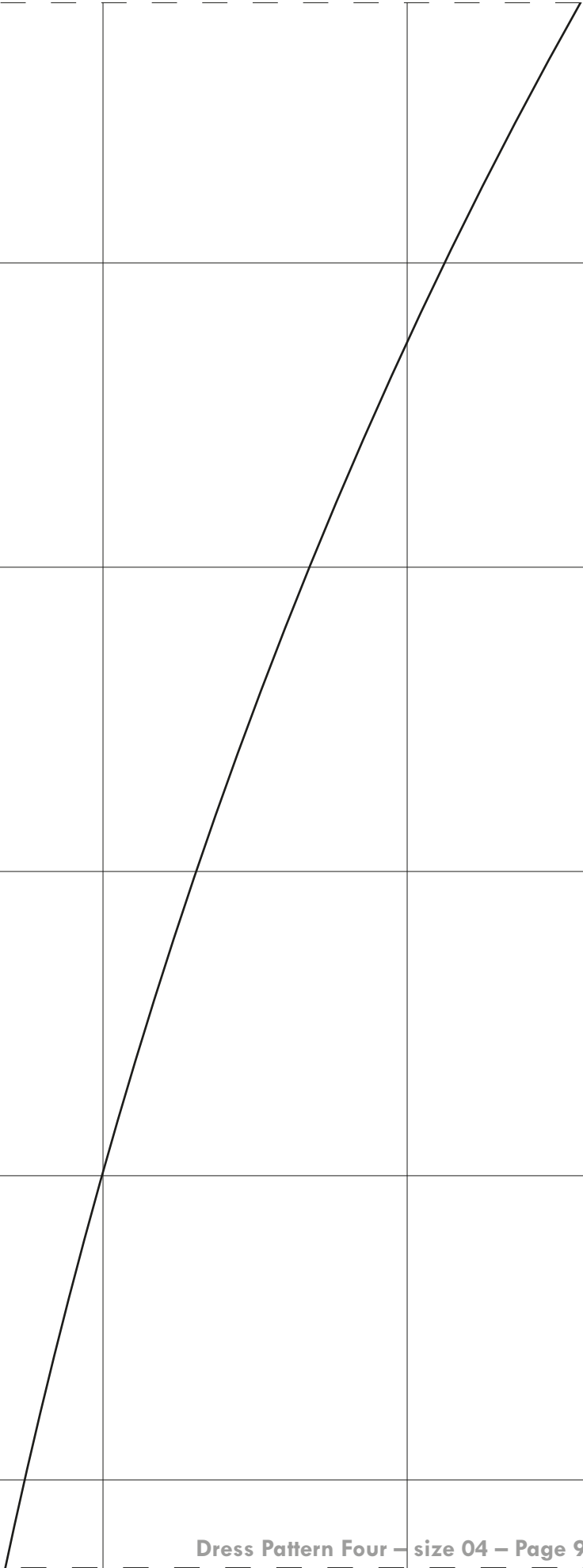

B2

B2

B2

B2

B3

B3

SKIRT FRONT  
Cut 2 fabric

B3

B3

B4

B4

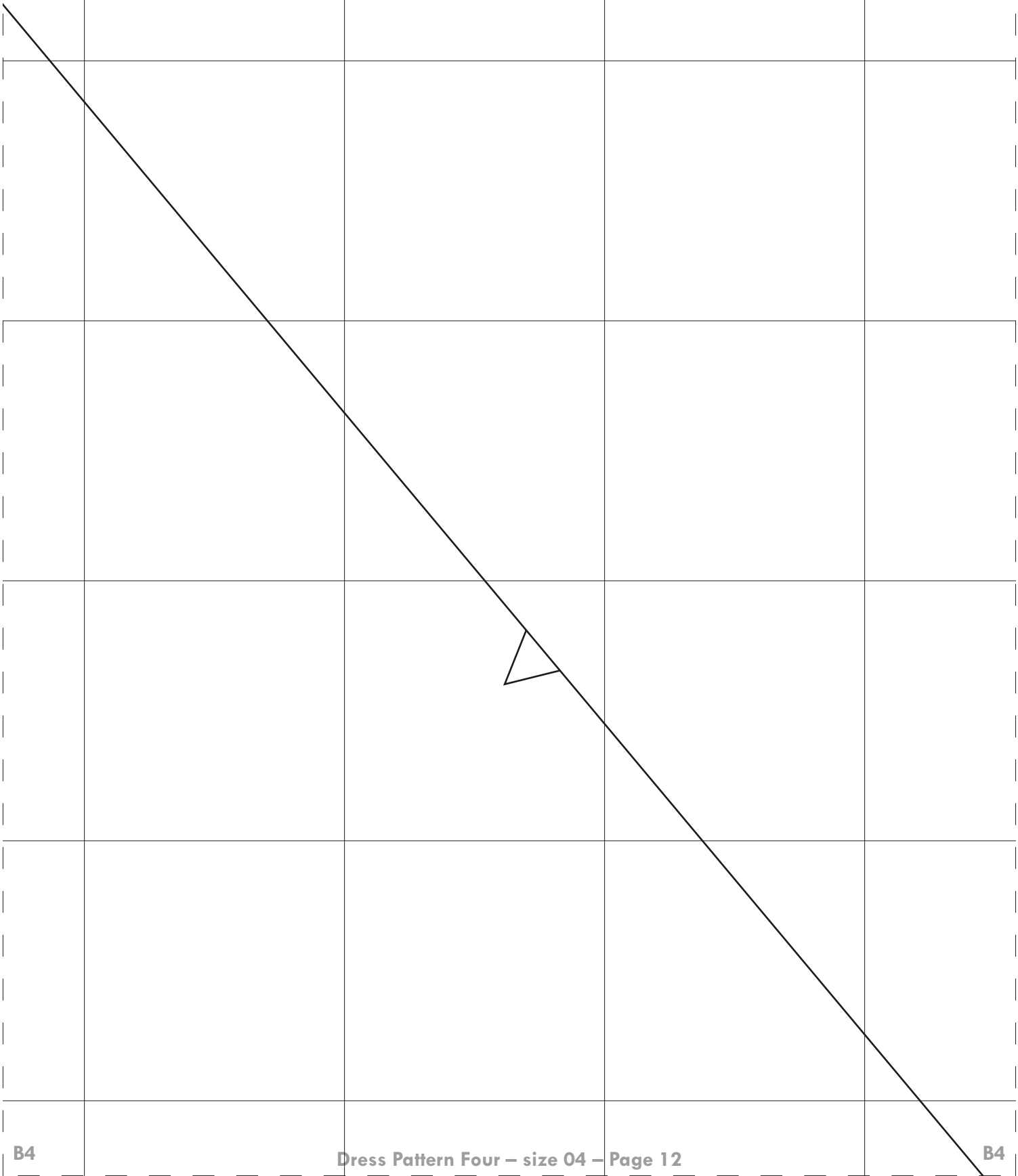

B4

B4

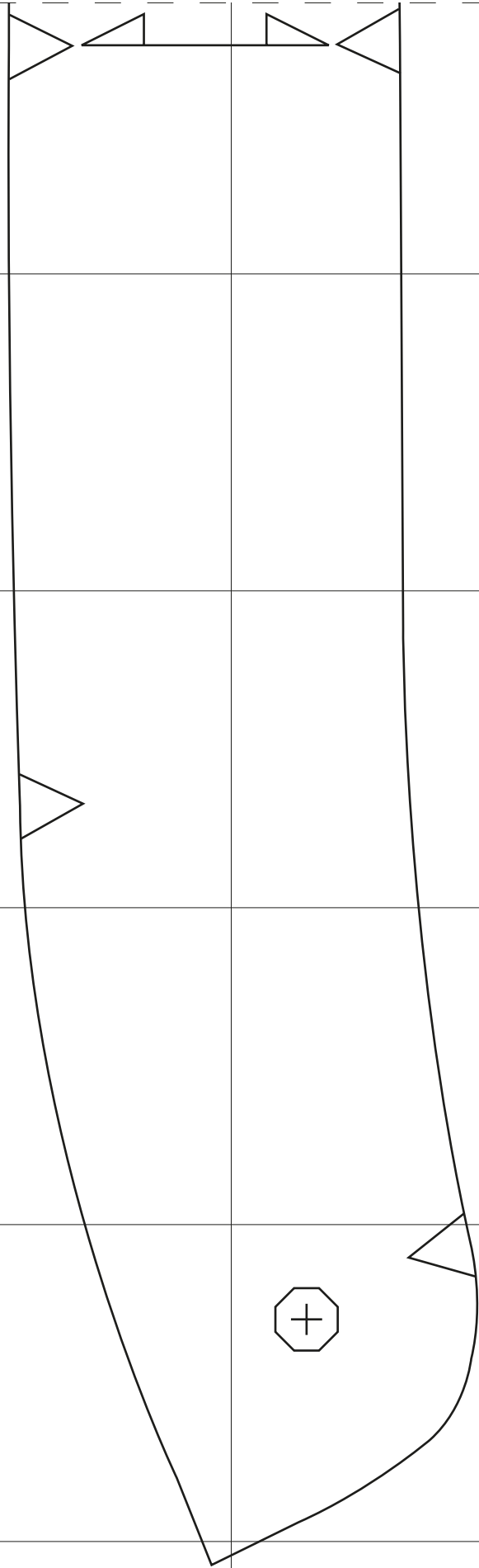

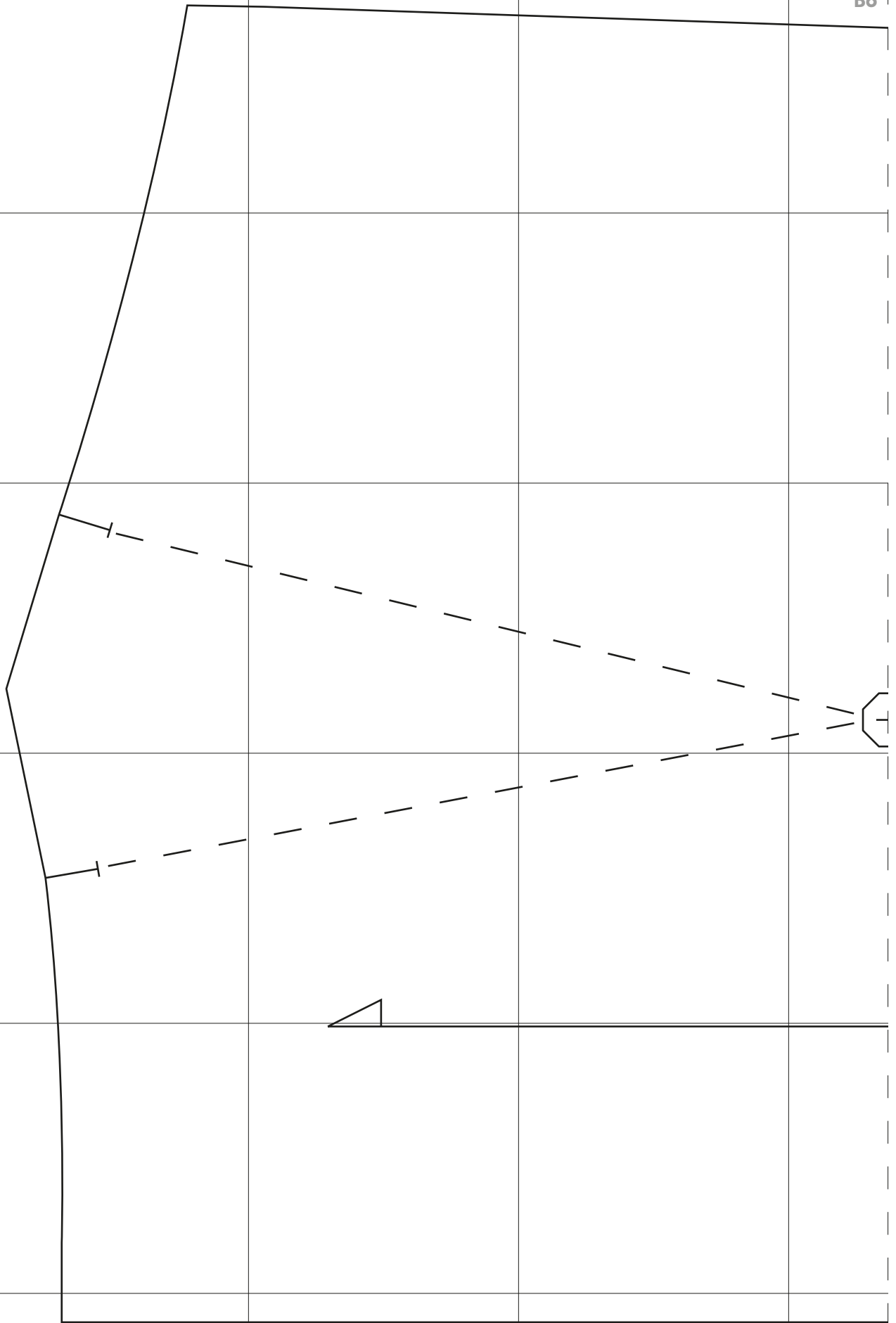

B7

B7

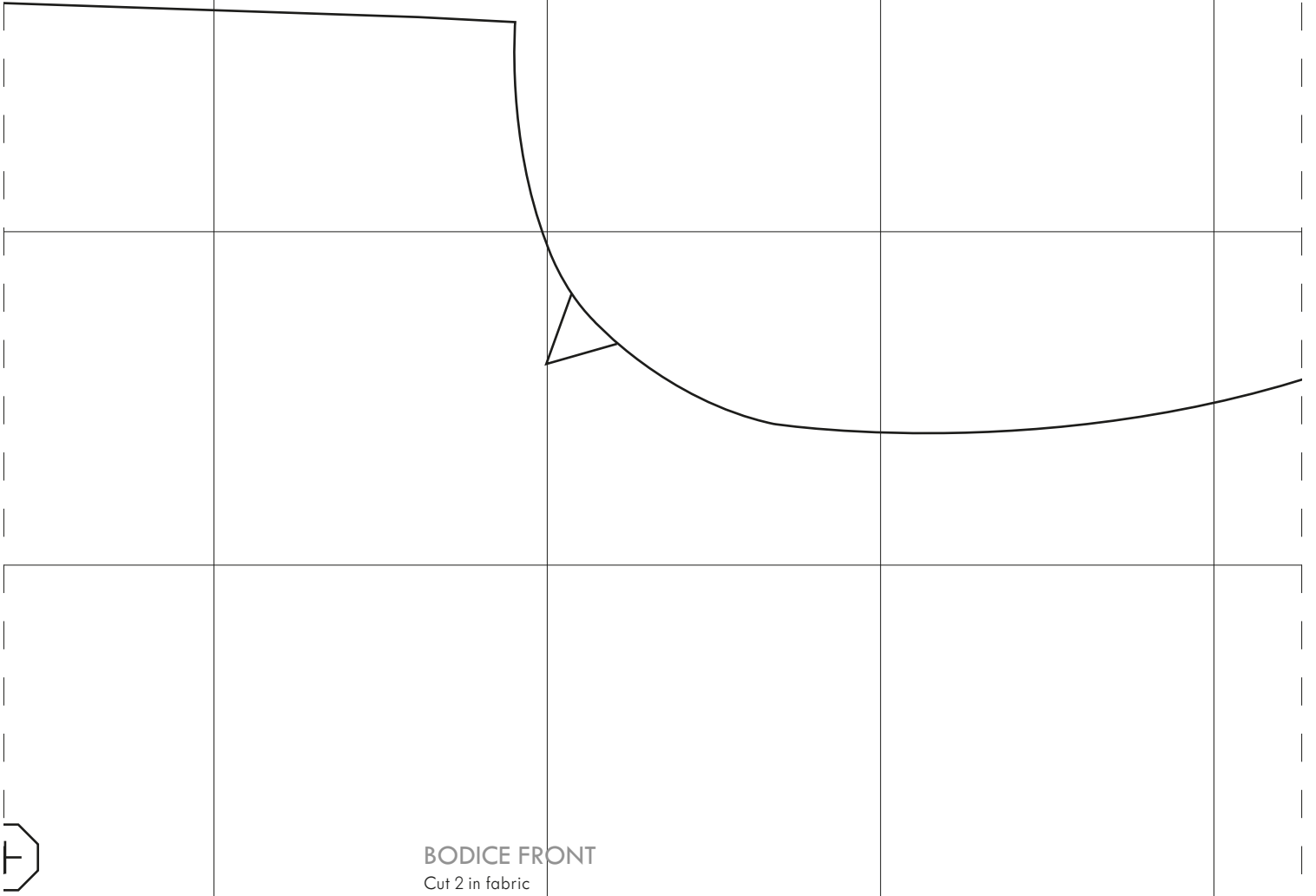

BODICE FRONT  
Cut 2 in fabric



B7

B7

B8

B8

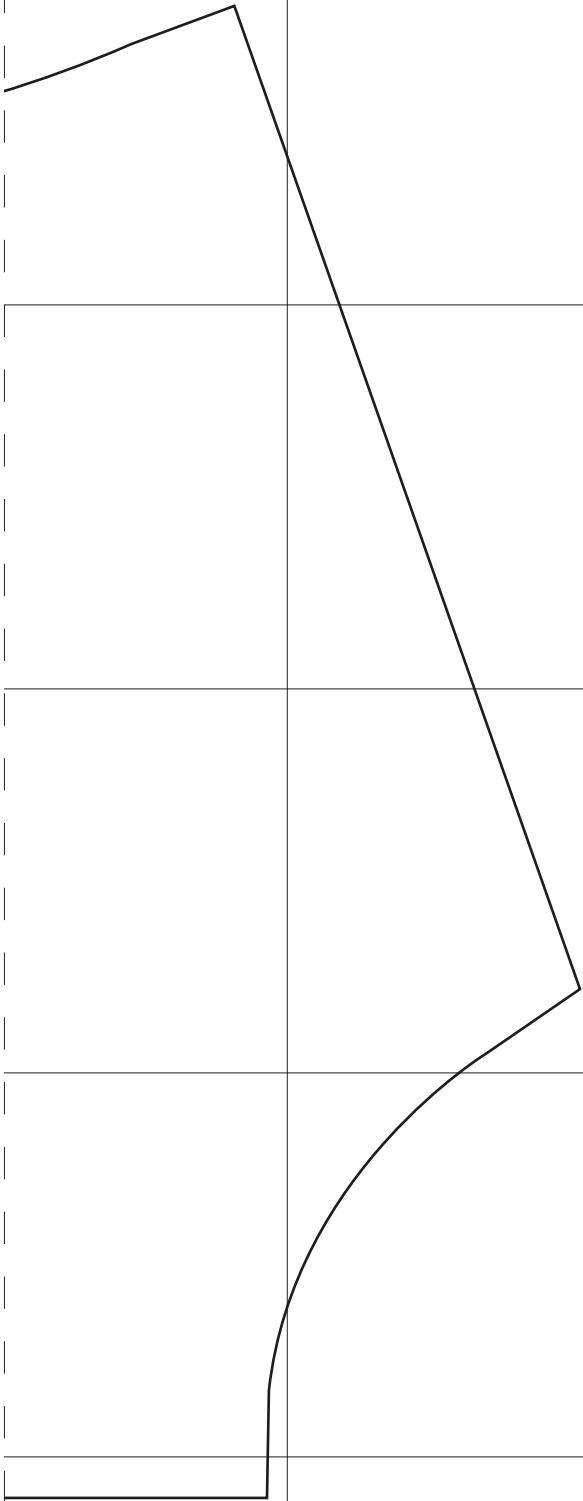

B8

B8



C1

C1

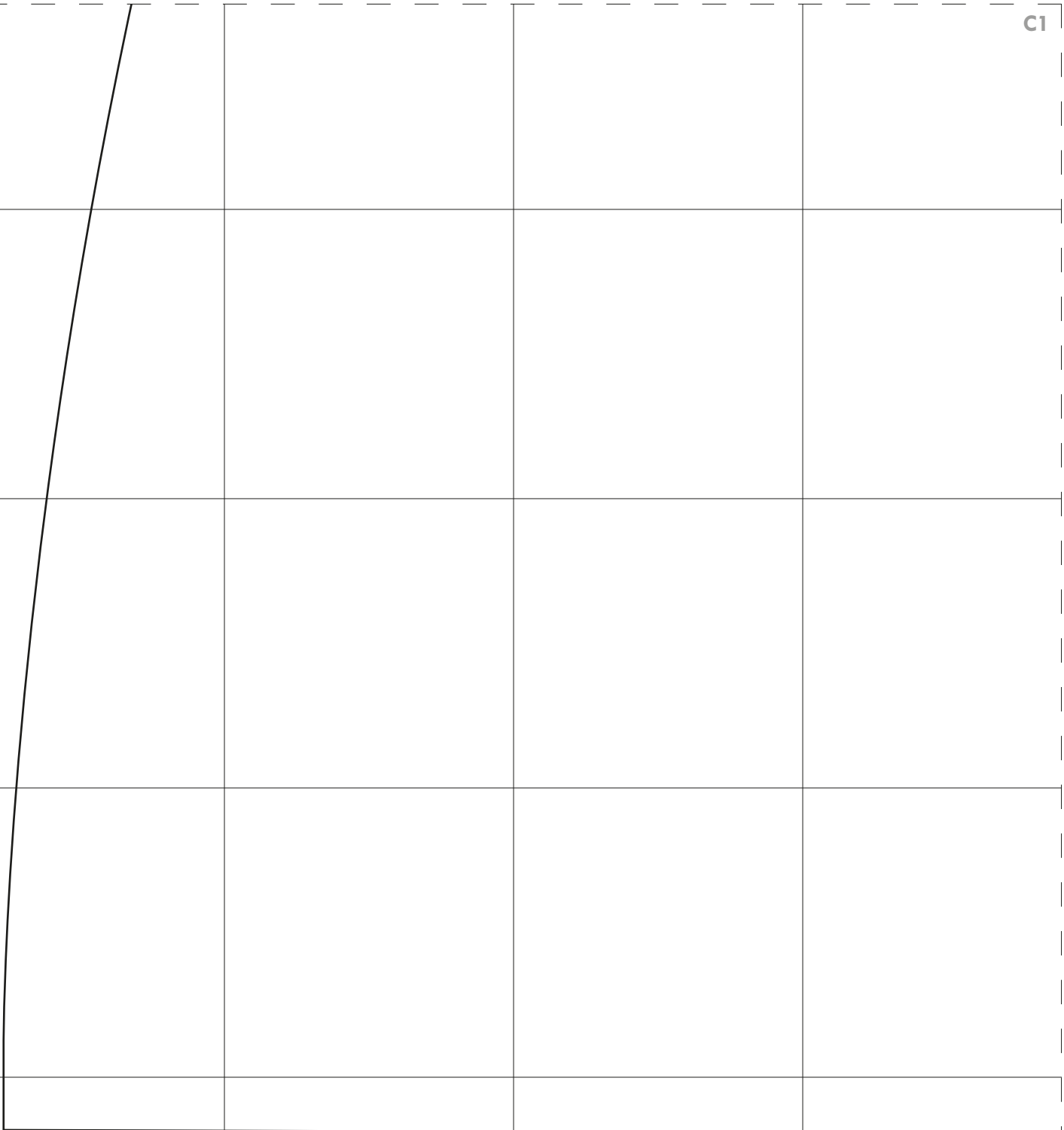

C1

C1

C2

C2

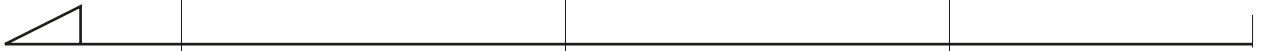

C2

C2

C3

C3



C3

C3

C4

C4



C4

C4

C5

C5

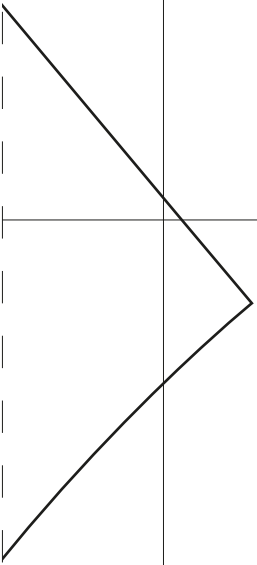

C5

C5

C6

C6

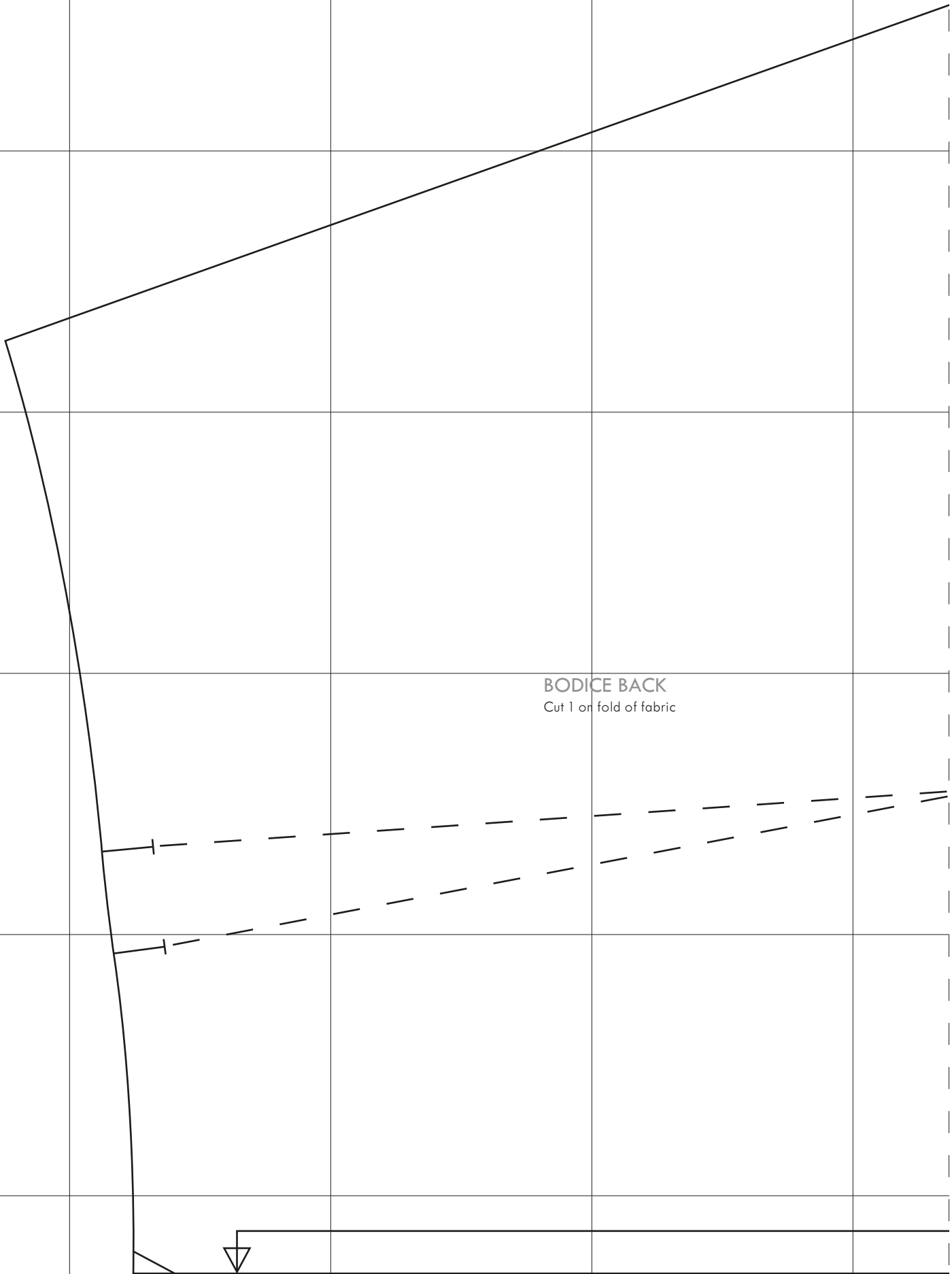

BODICE BACK  
Cut 1 or fold of fabric

C6

C6

C7

C7

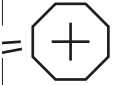
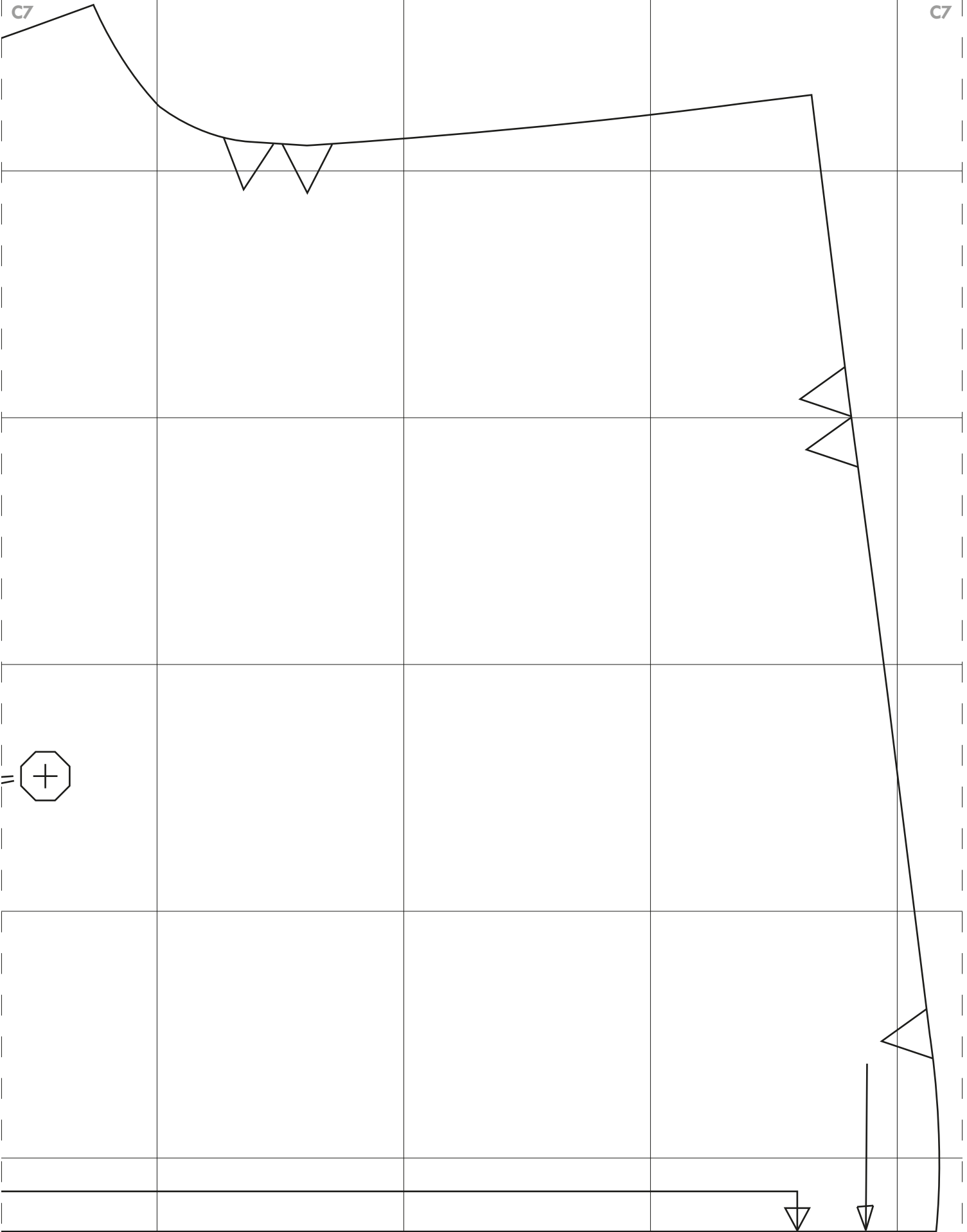

C7

C7

C8

C8

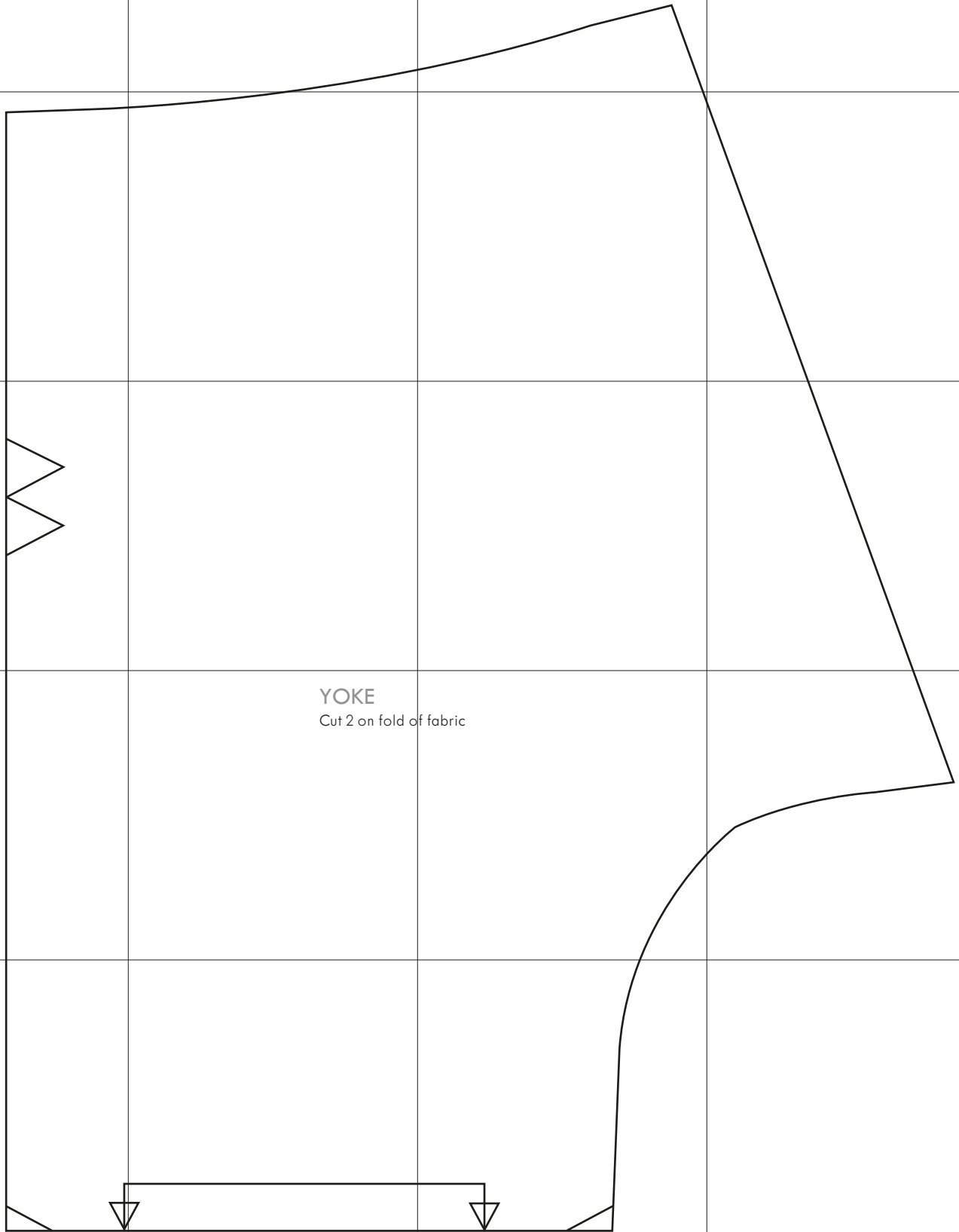

C8

C8



D1

D1

D1

D1

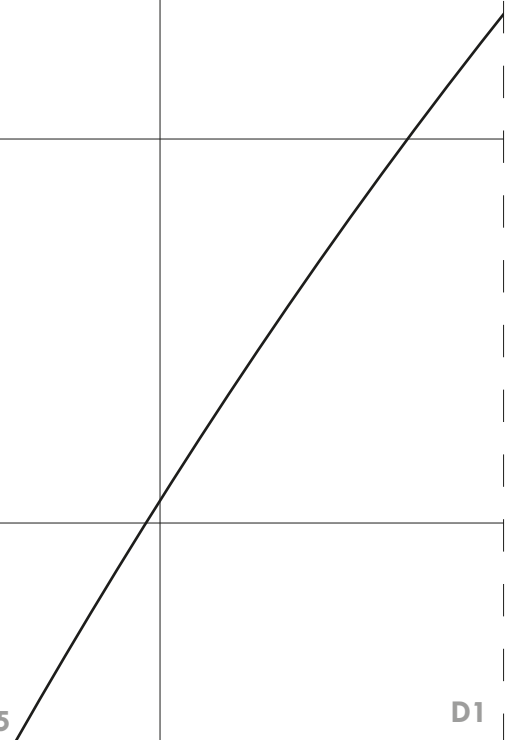

D2

D2

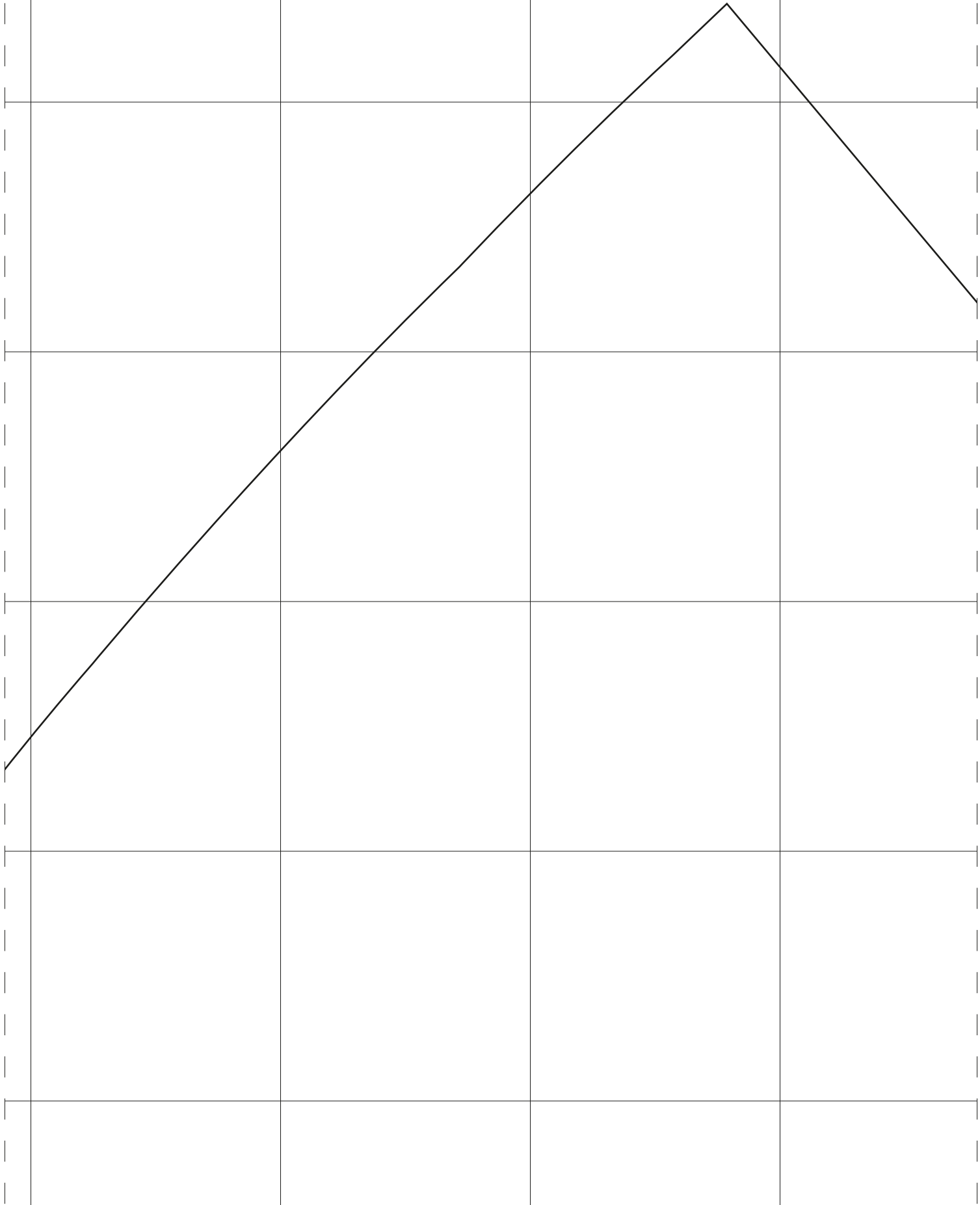

D2

D2

D3

D3

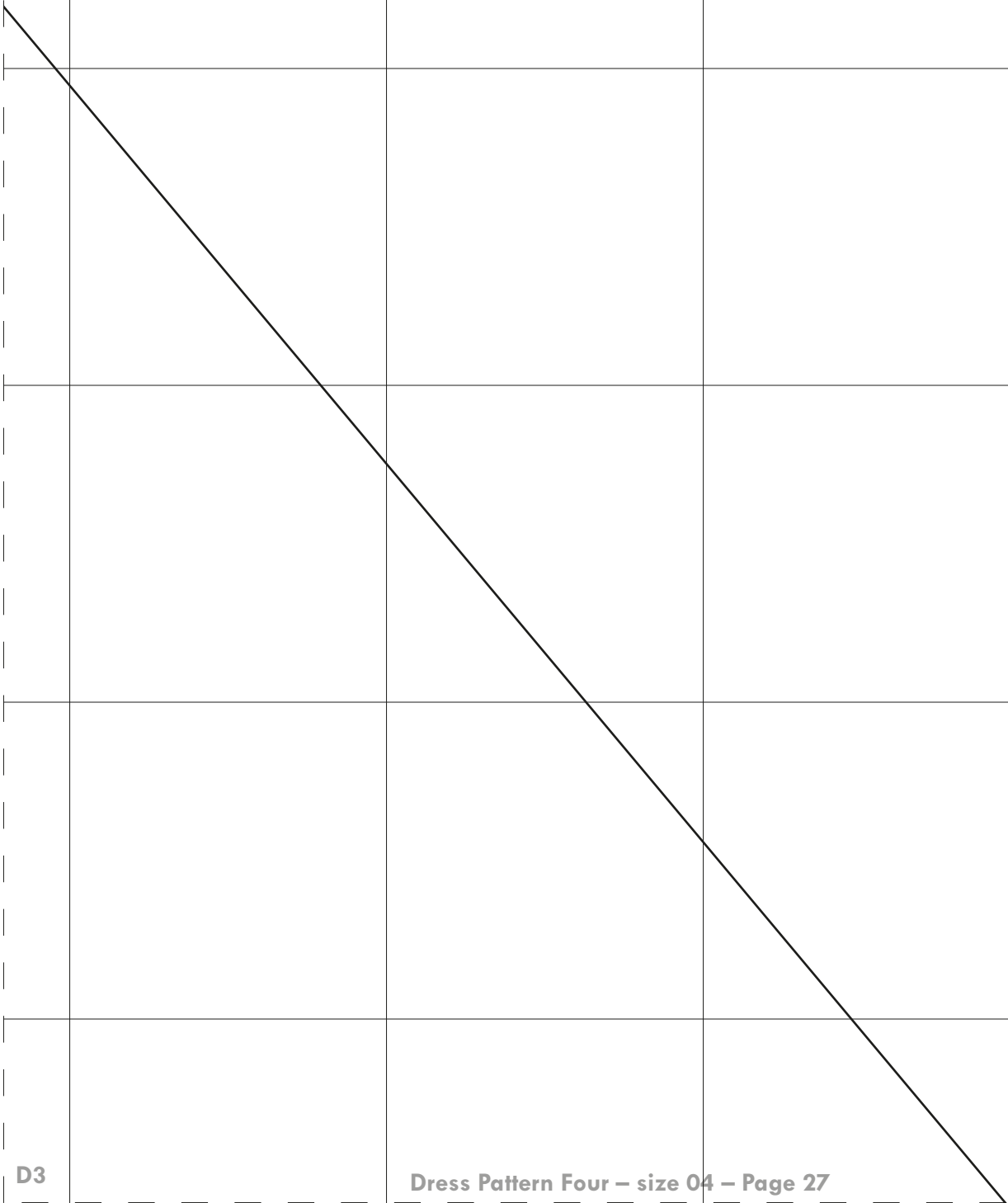

D3

D3

D4

D4

D4

D4

D5

D5

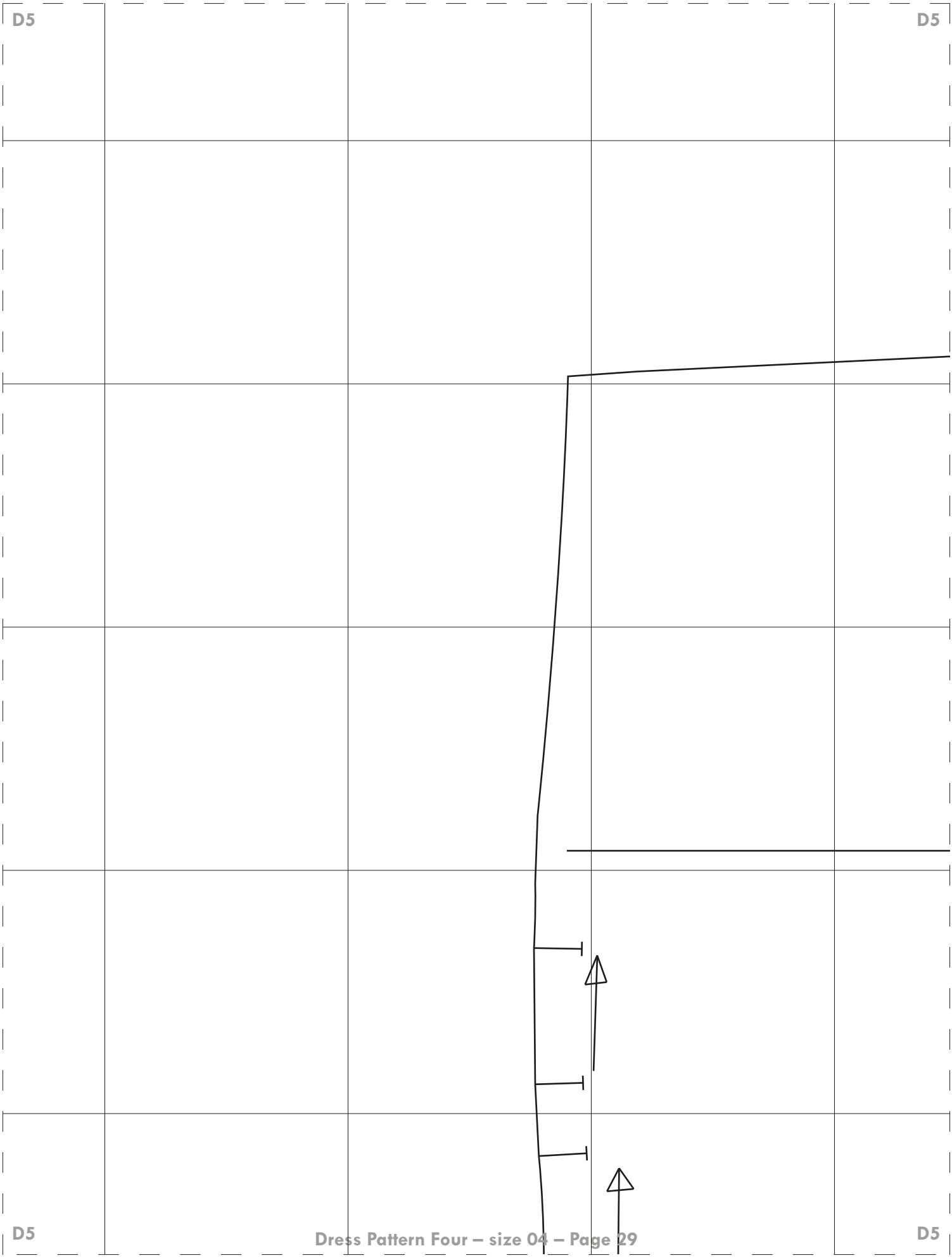

D5

D5

D6

D6

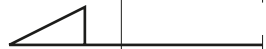
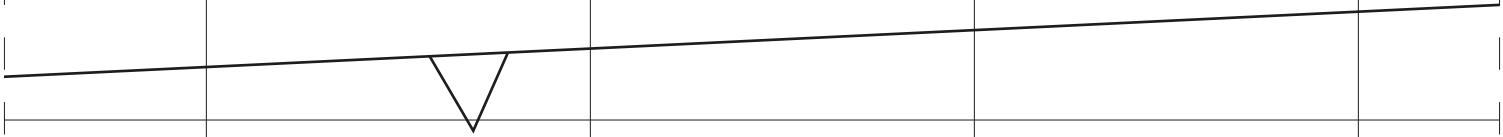

D6

D6

D7

D7

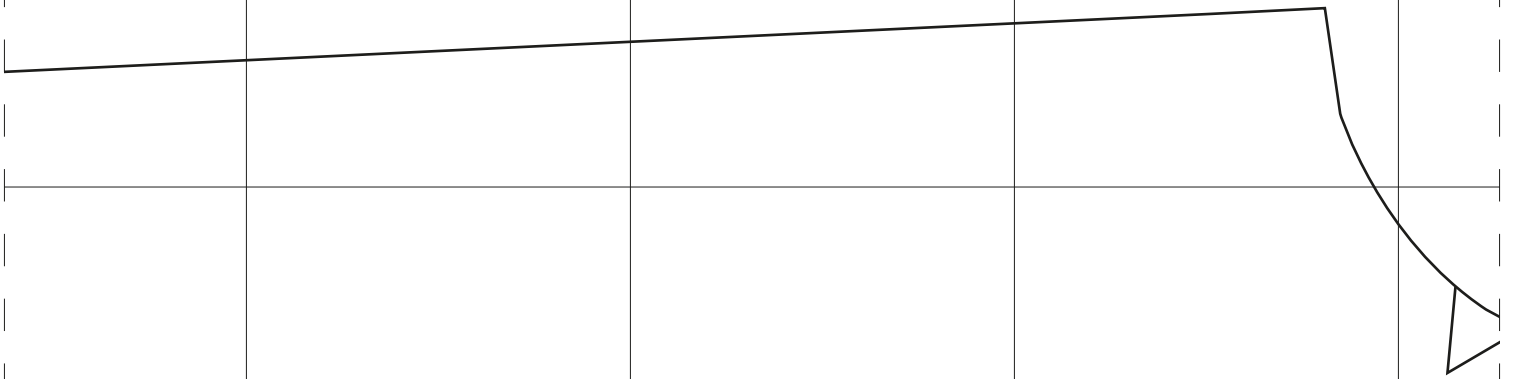

SLEEVE  
Cut 2 fabric

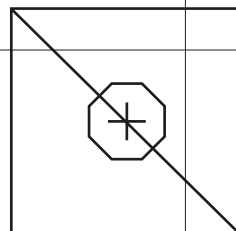
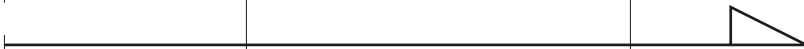

D7

D7

D8

D8

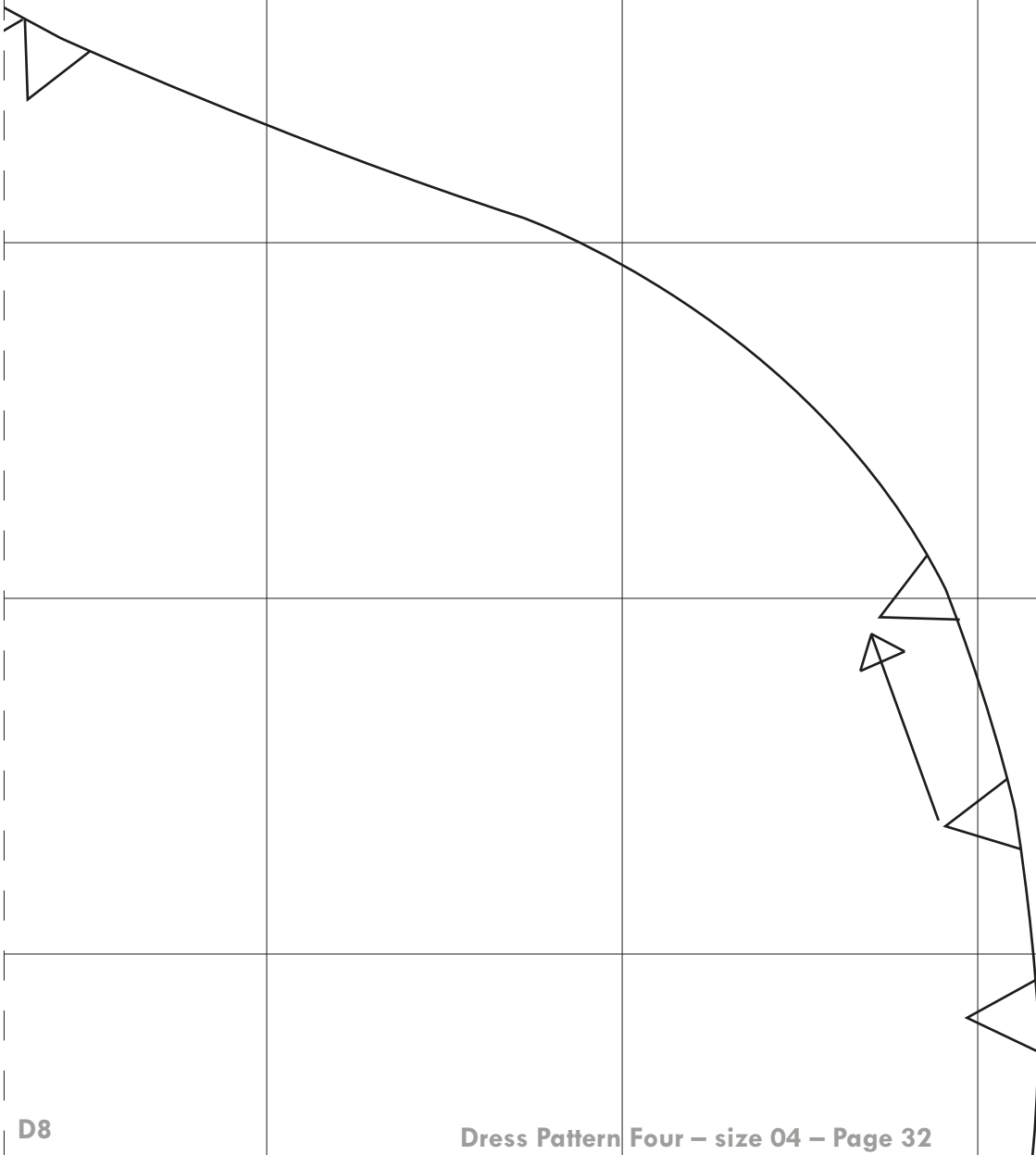

D8

D8



E1

E1

E1

E1

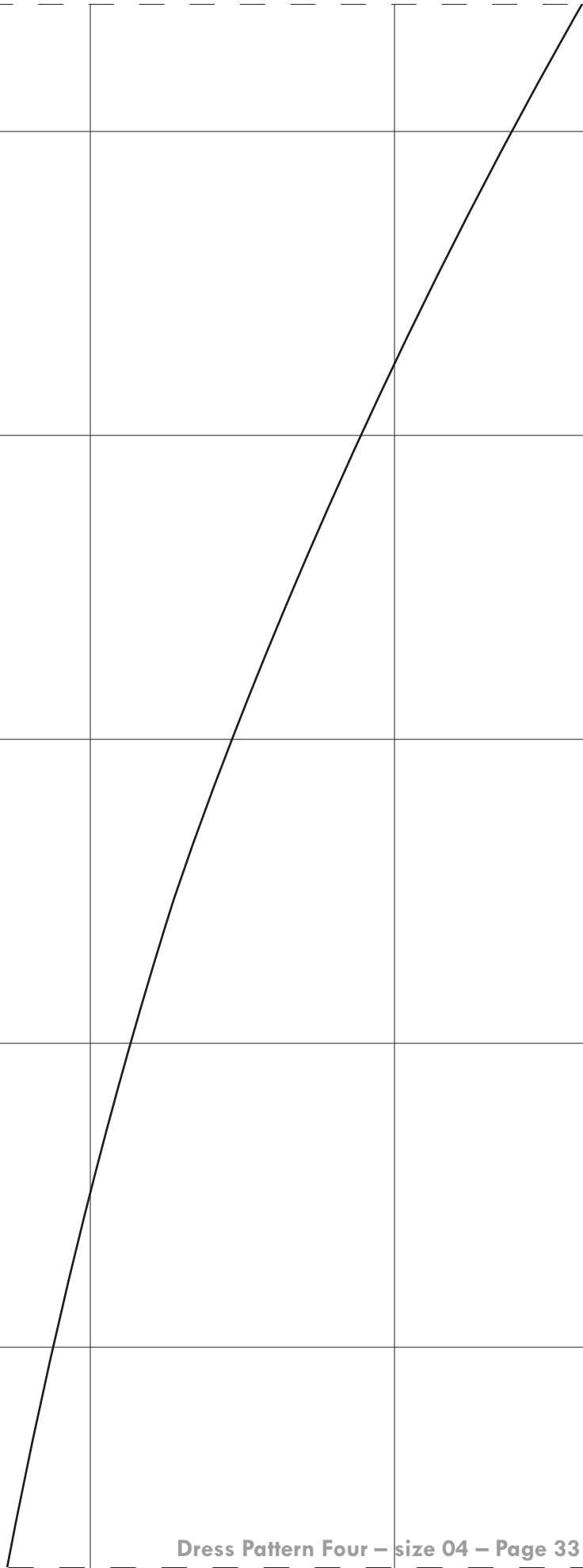

E2

E2

E2

E2

E3

E3

SKIRT BACK  
Cut 1 on fold of fabric

E3

E3

E4

E4

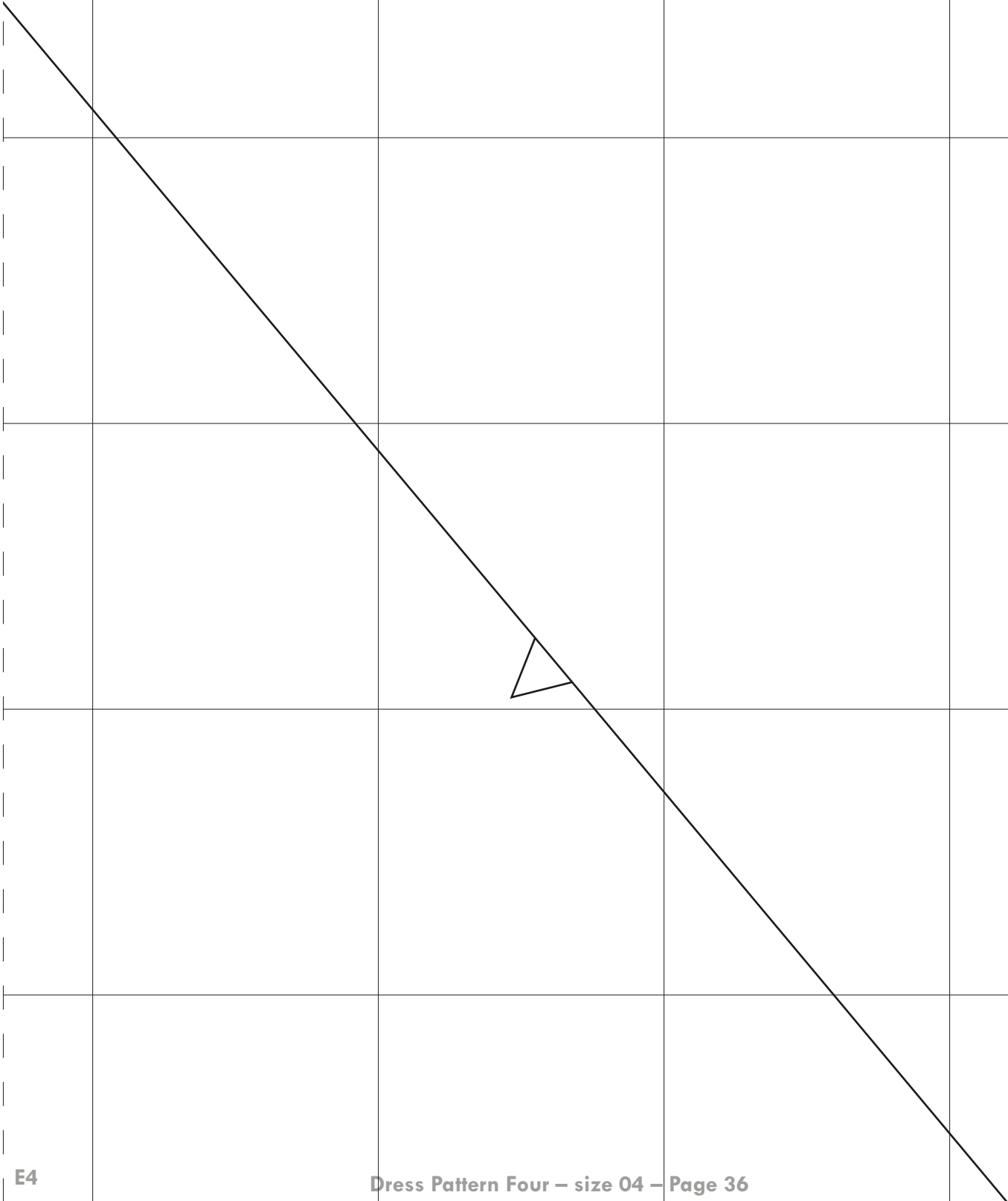

E4

E4

E5

E5

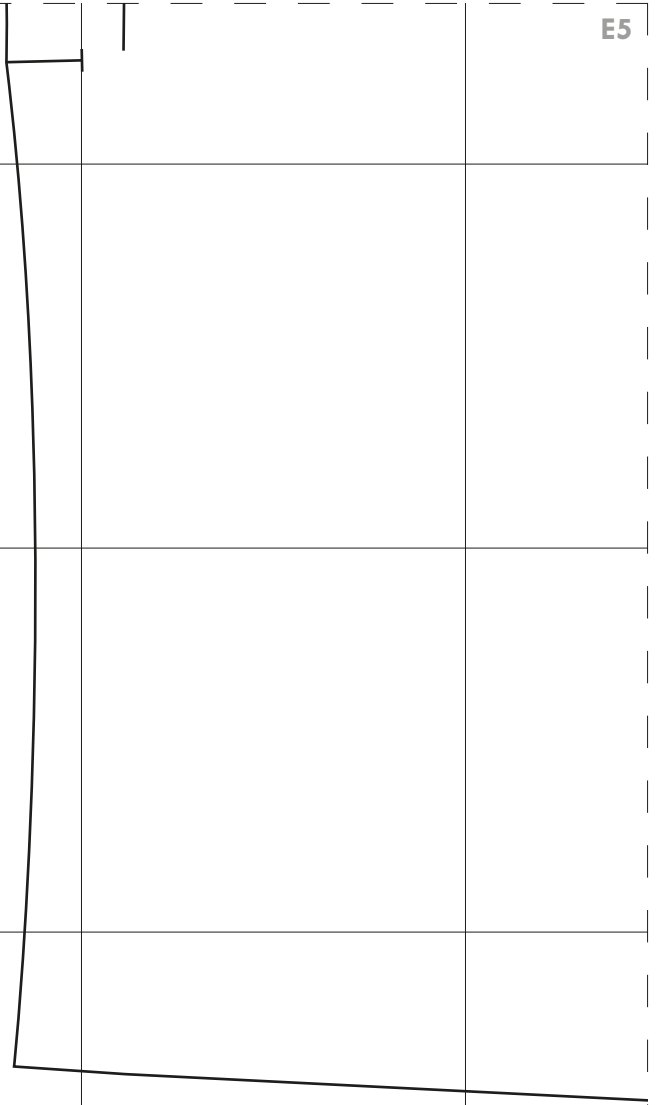

E5

E5



E7

E7



E7

E7

E8

E8

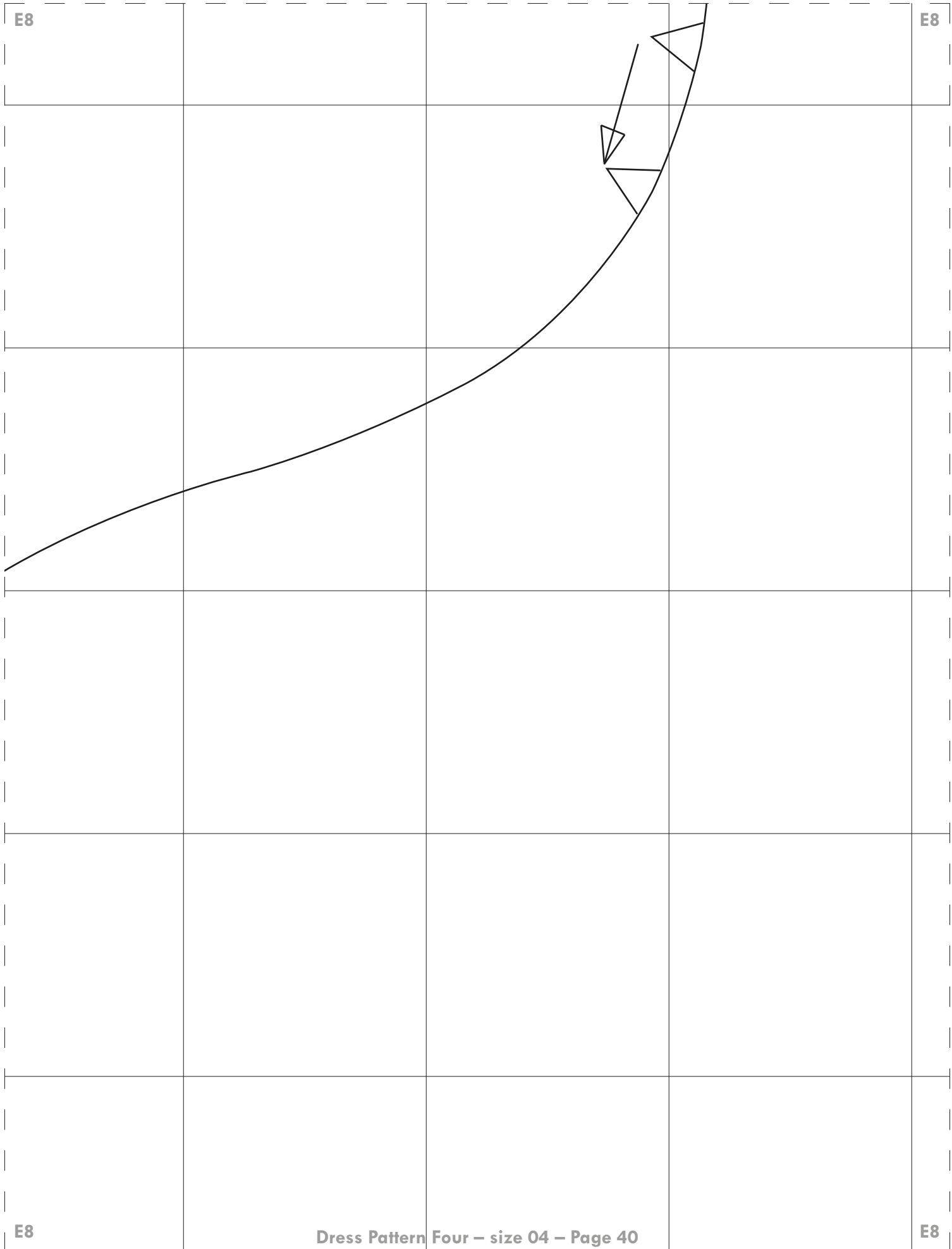

E8

E8



F1

F1

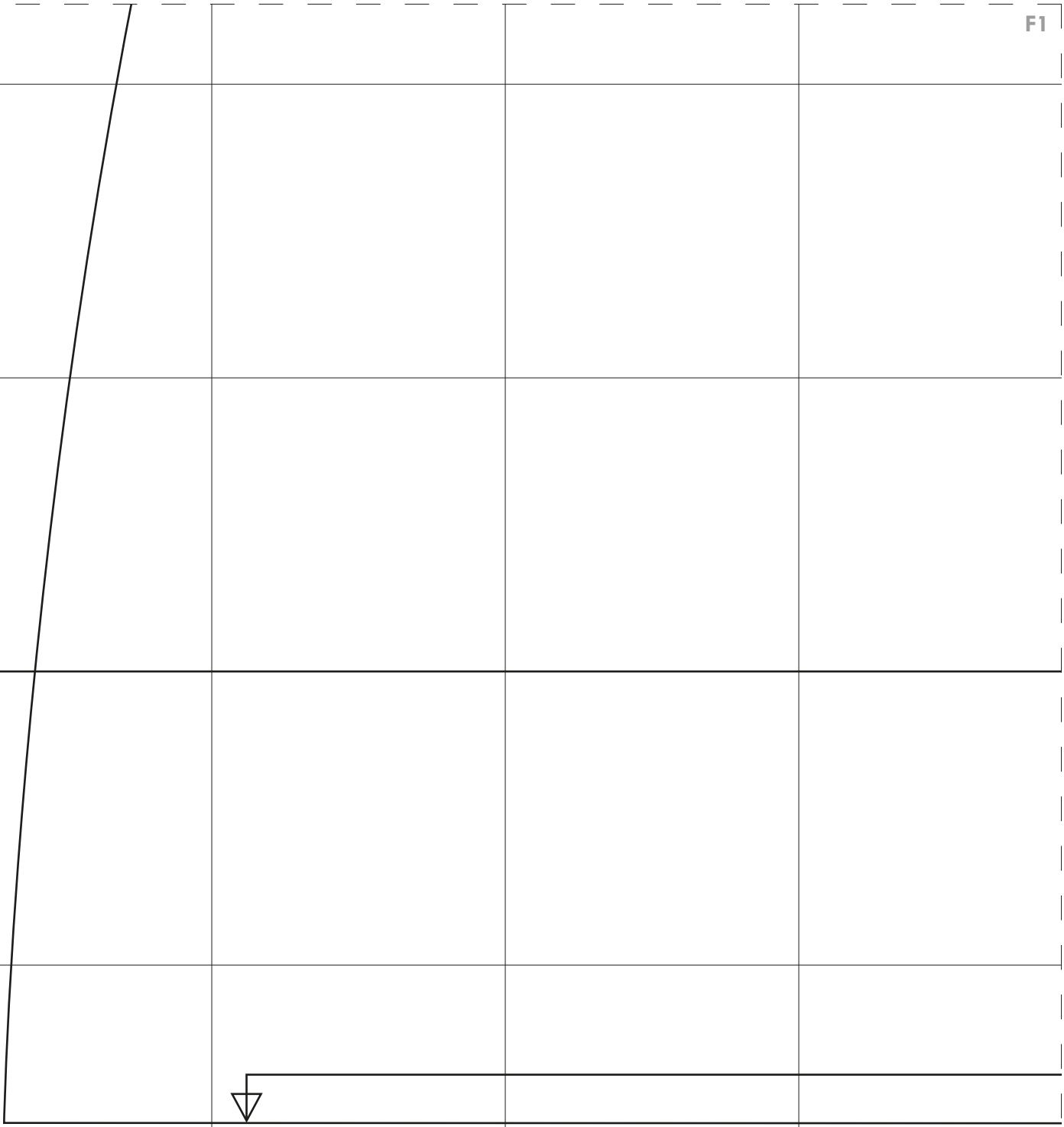

F1

F1

F2

F2

F2

F2

F3

F3

F3

F3

F4

F4

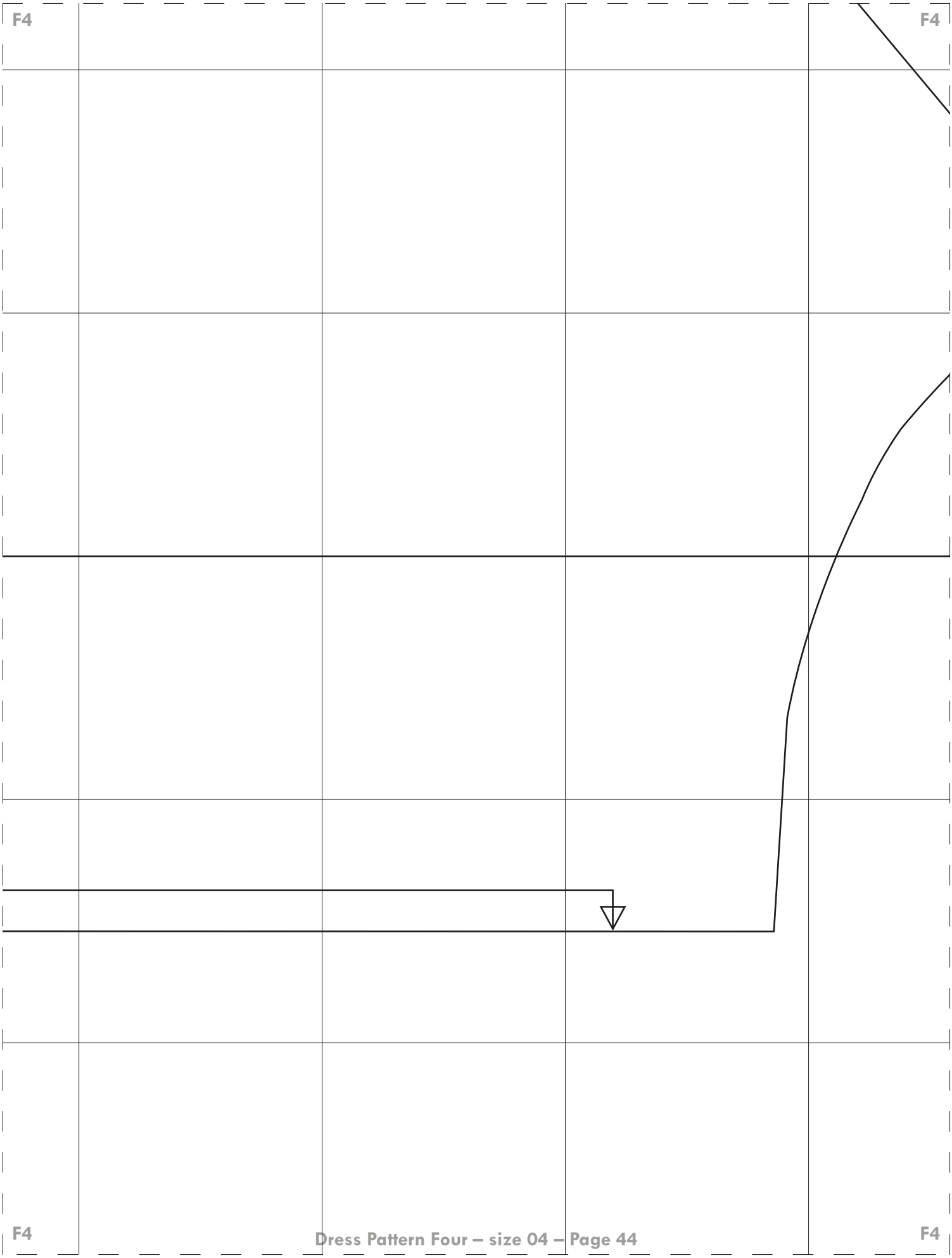

F4

F4

F5

F5

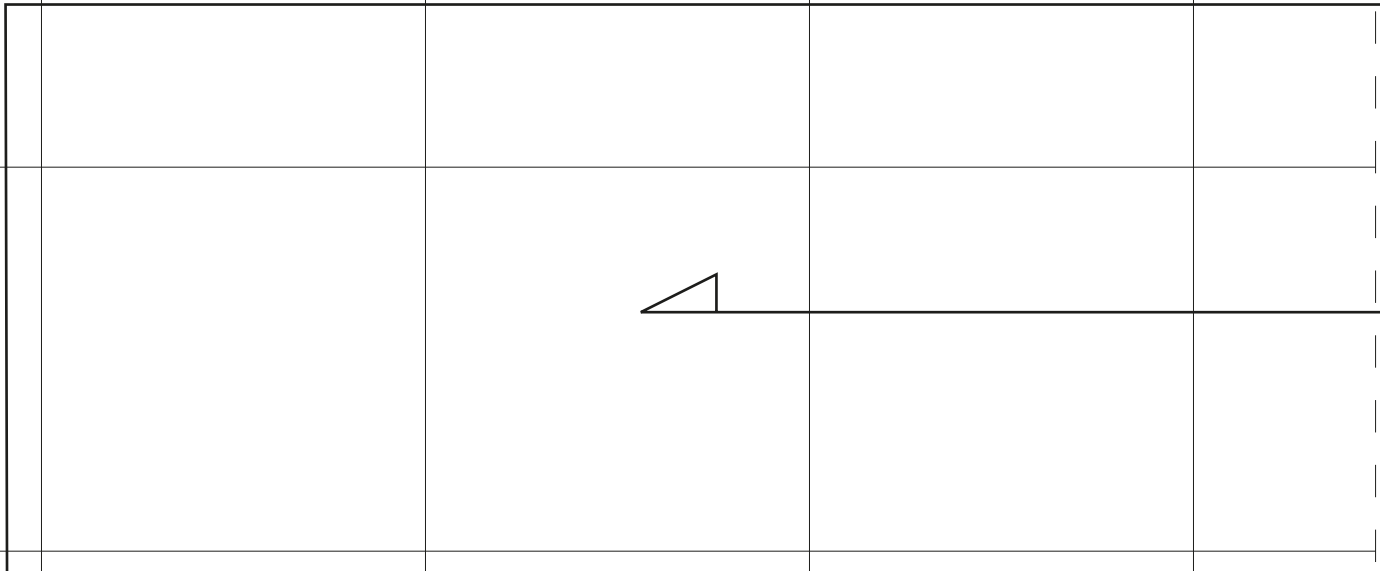
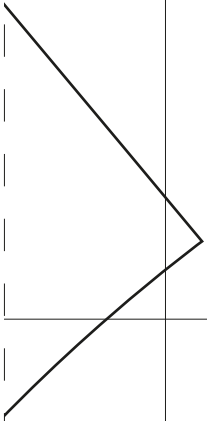

SLEEVE TAB FOR VARIATION

Cut 2 fabric  
Cut 2 interfacing

F5

F5

F6

F6

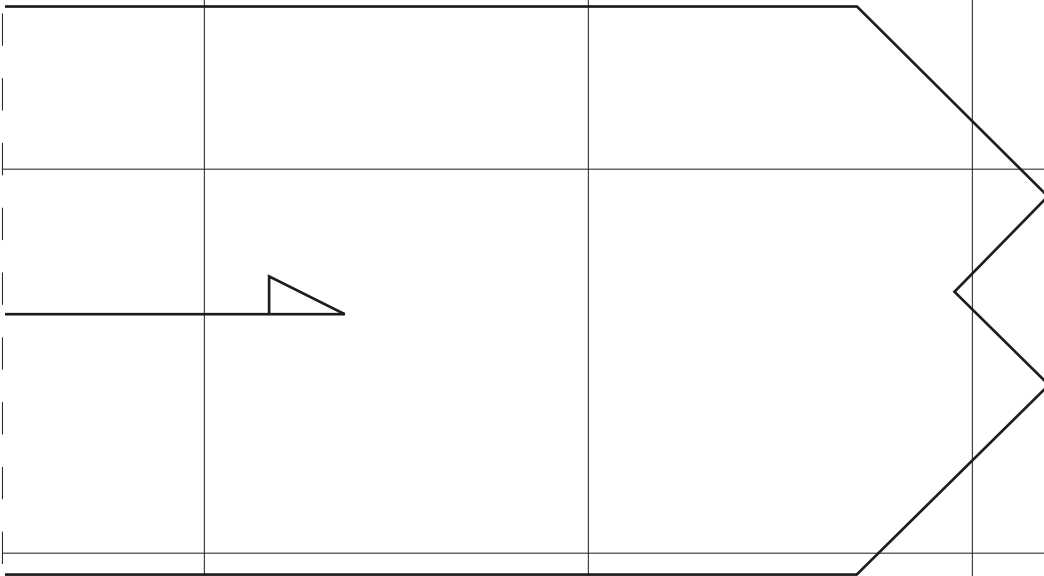

F6

F6

F7

F7

SLEEVE OPENING BINDING  
Cut 2 fabric



F7

F7

F8

F8

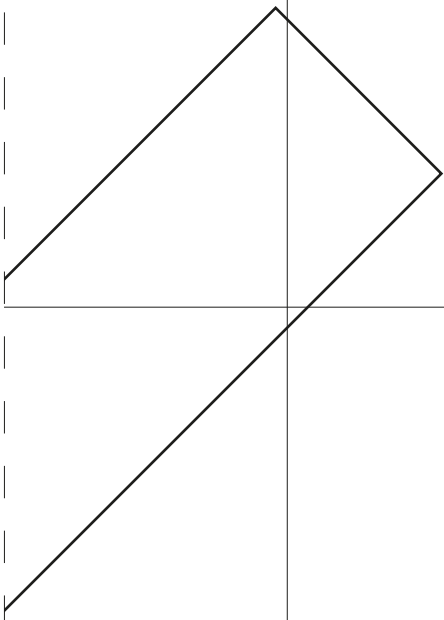

F8

F8



G1

G1



G1

G1

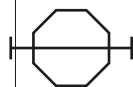
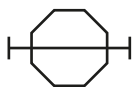

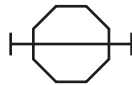
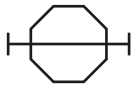

FRONT BUTTON PLACKET

Cut 4 fabric  
Cut 2 interfacing

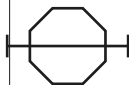

G5

G5

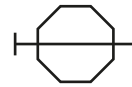
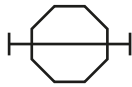

G5

G5

