

A1

A1

A1

A1

A2

A2

A2

A2

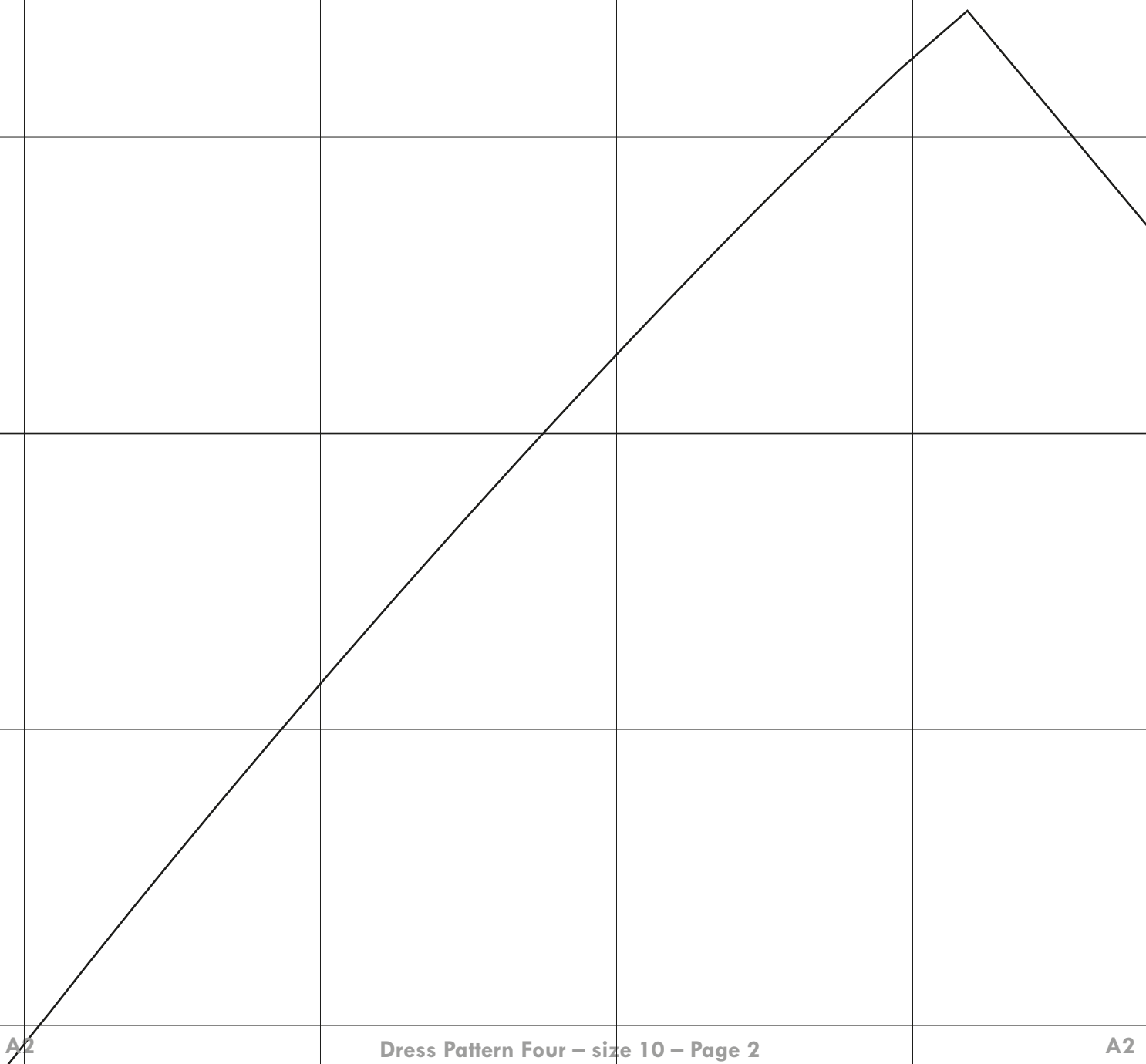

A3

A3

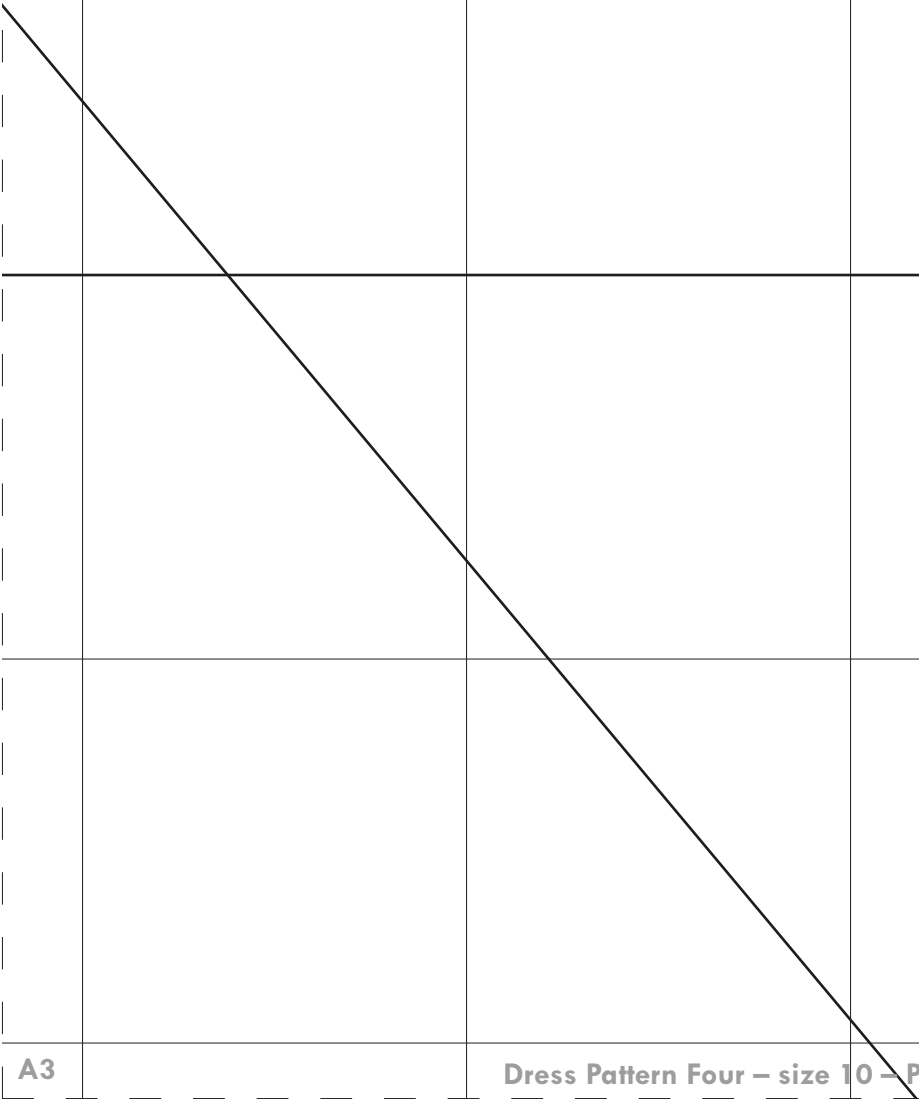

A3

A3



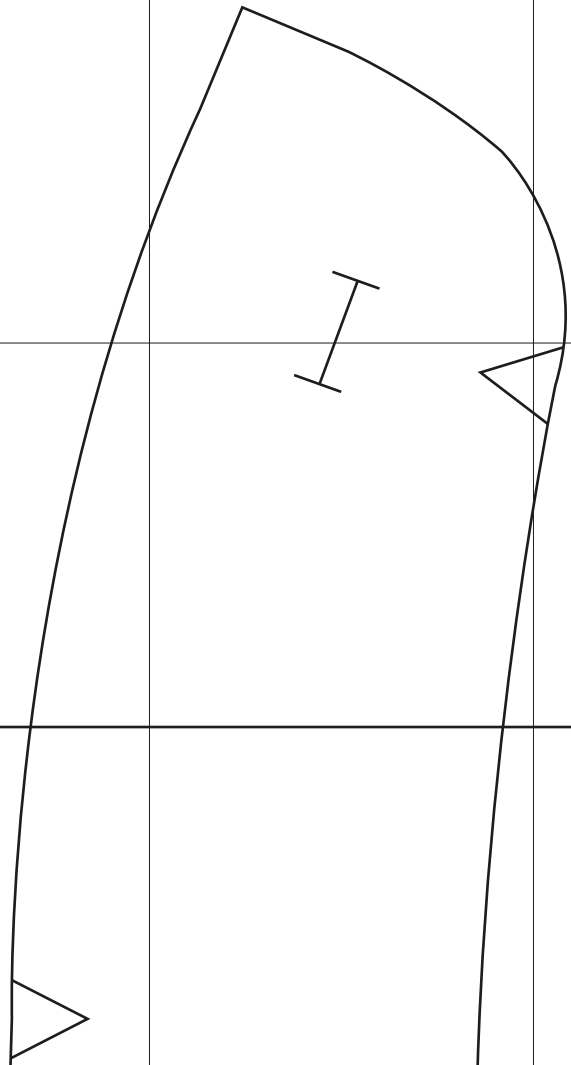

**COLLAR STAND**  
Cut 2 fabric  
Cut 1 interfacing

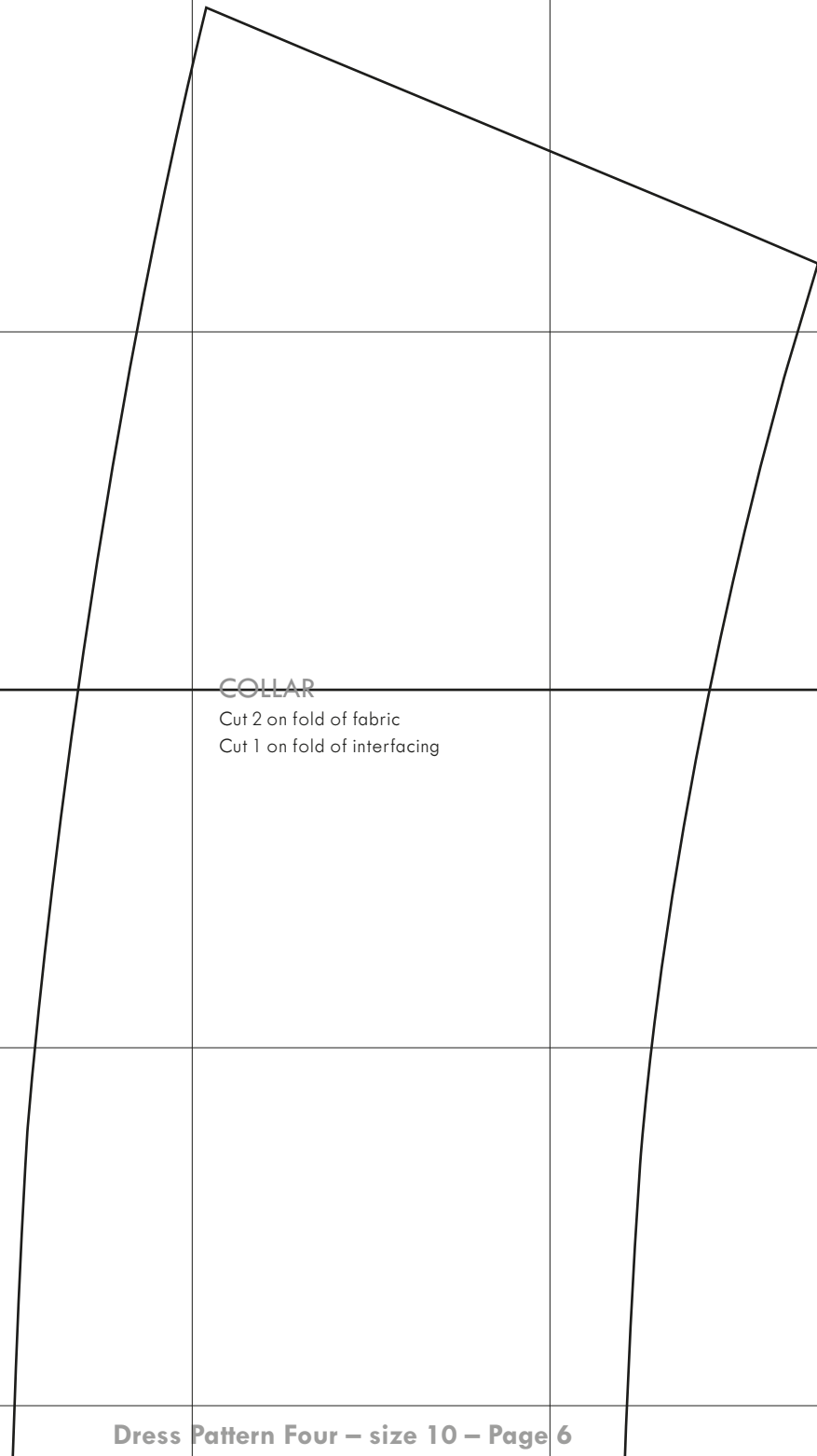

**COLLAR**

Cut 2 on fold of fabric  
Cut 1 on fold of interfacing

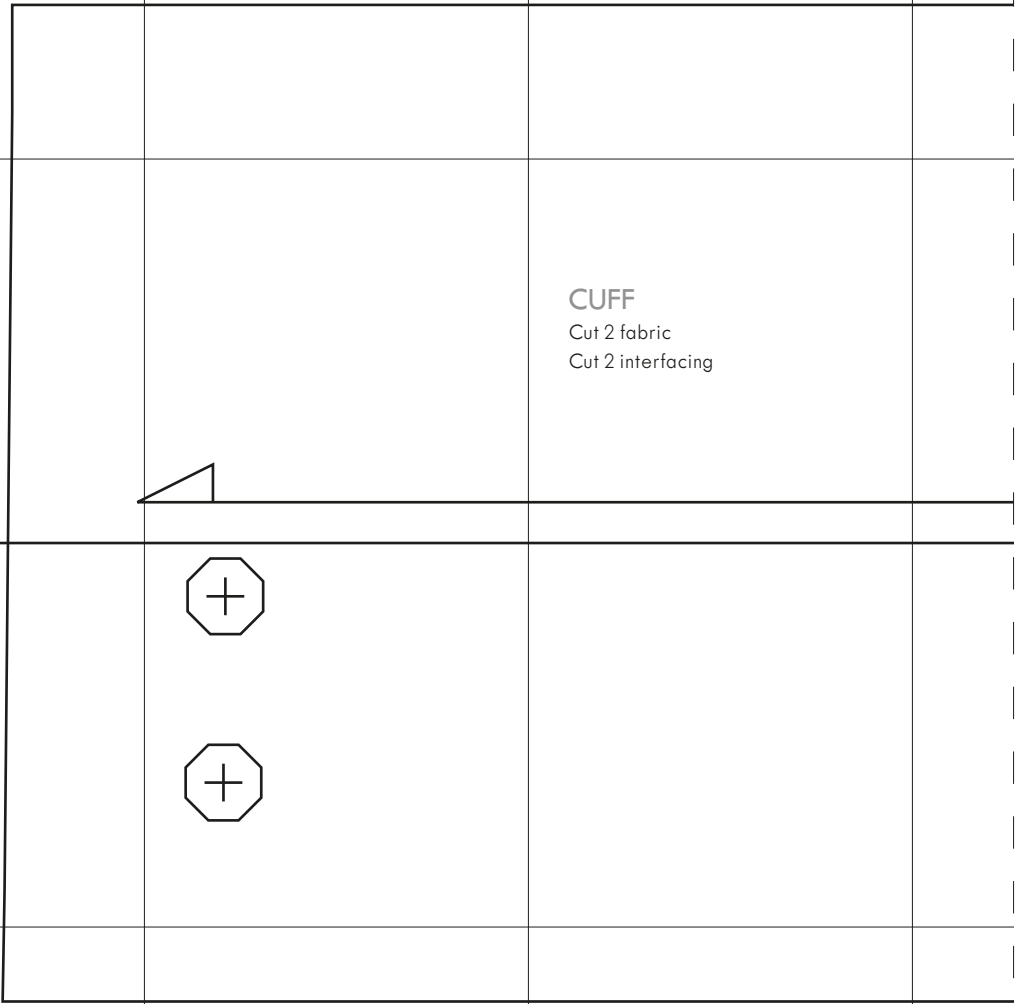

CUFF  
Cut 2 fabric  
Cut 2 interfacing



A8

A8

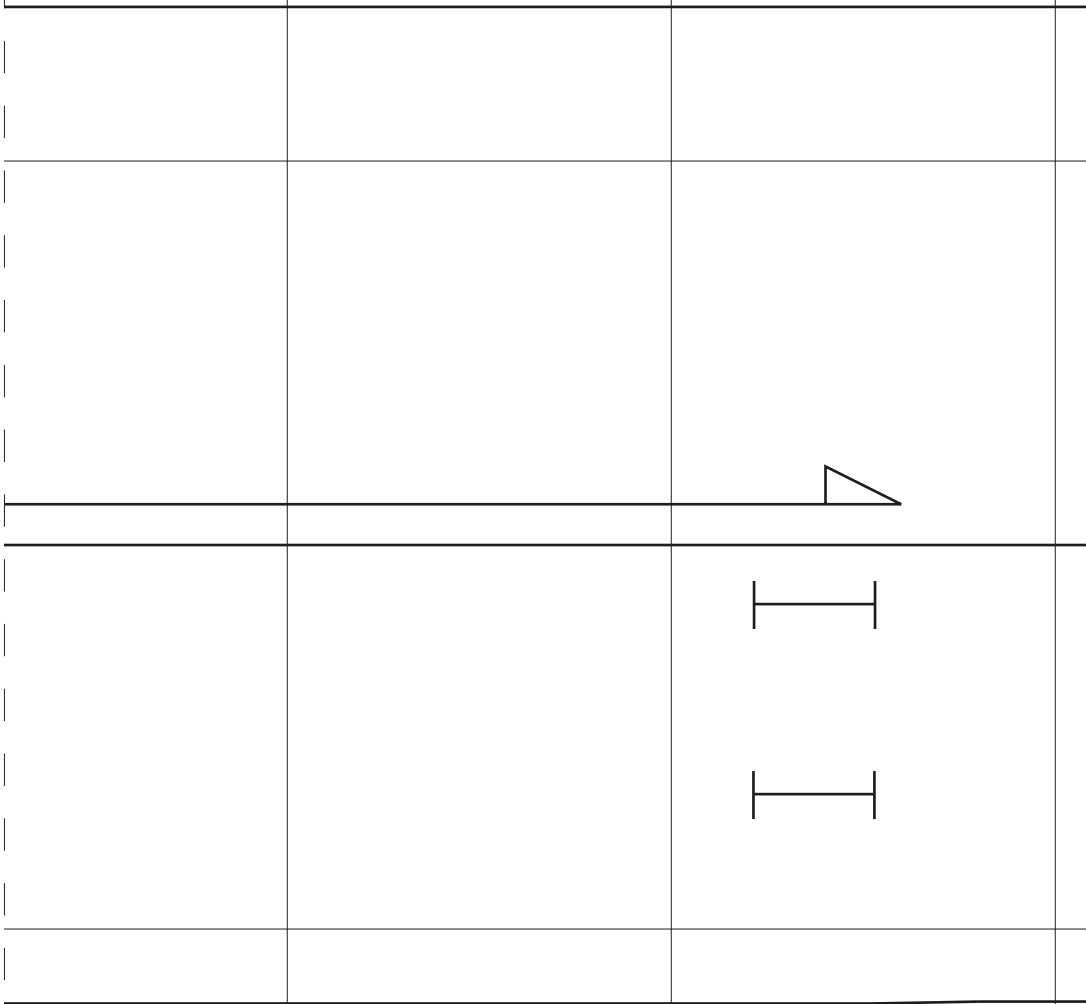

A8

A8



B1

B1

B1

B1

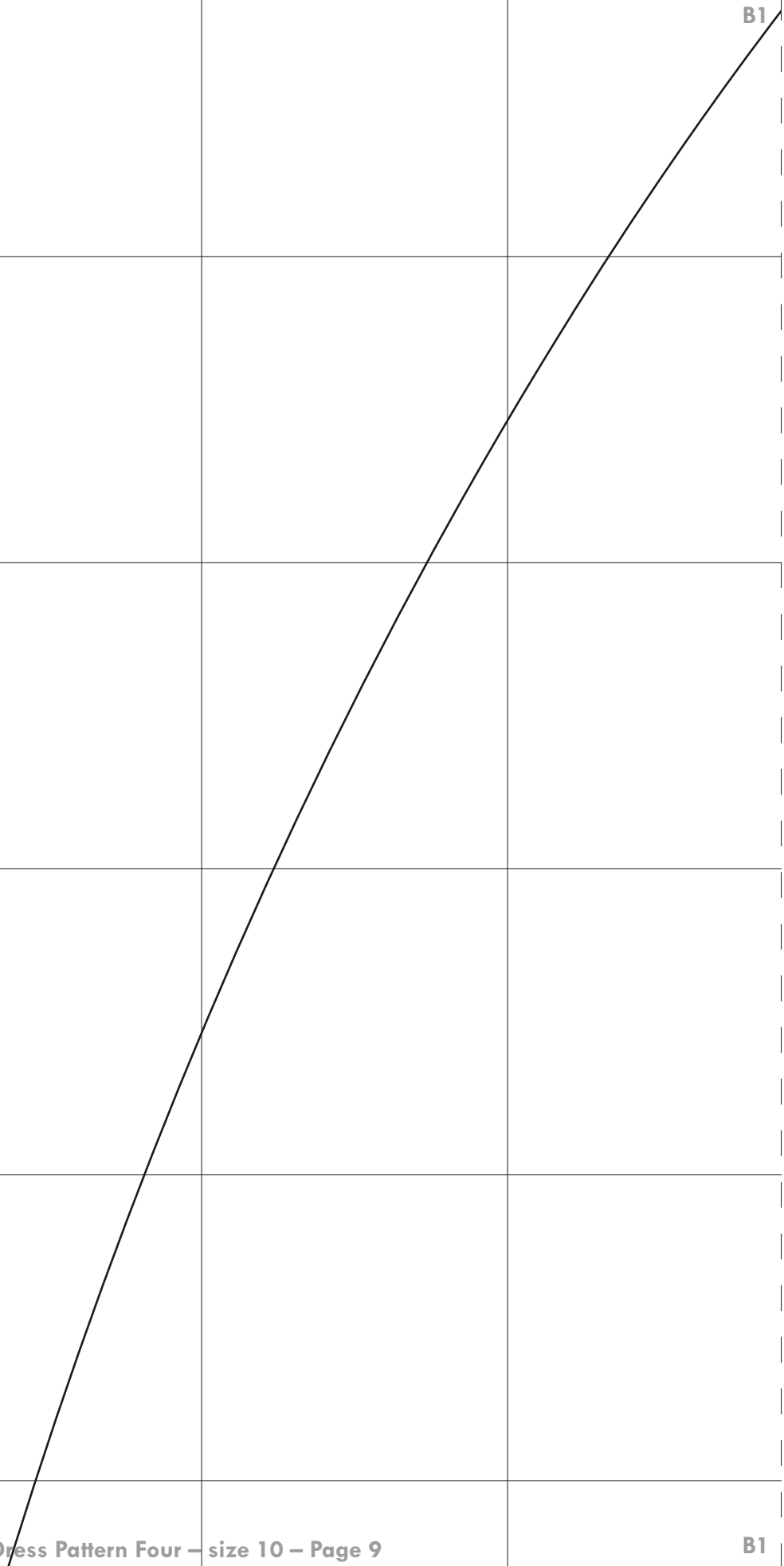

B2

B2

B2

B2

B3

B3

SKIRT FRONT  
Cut 2 fabric

B3

B3

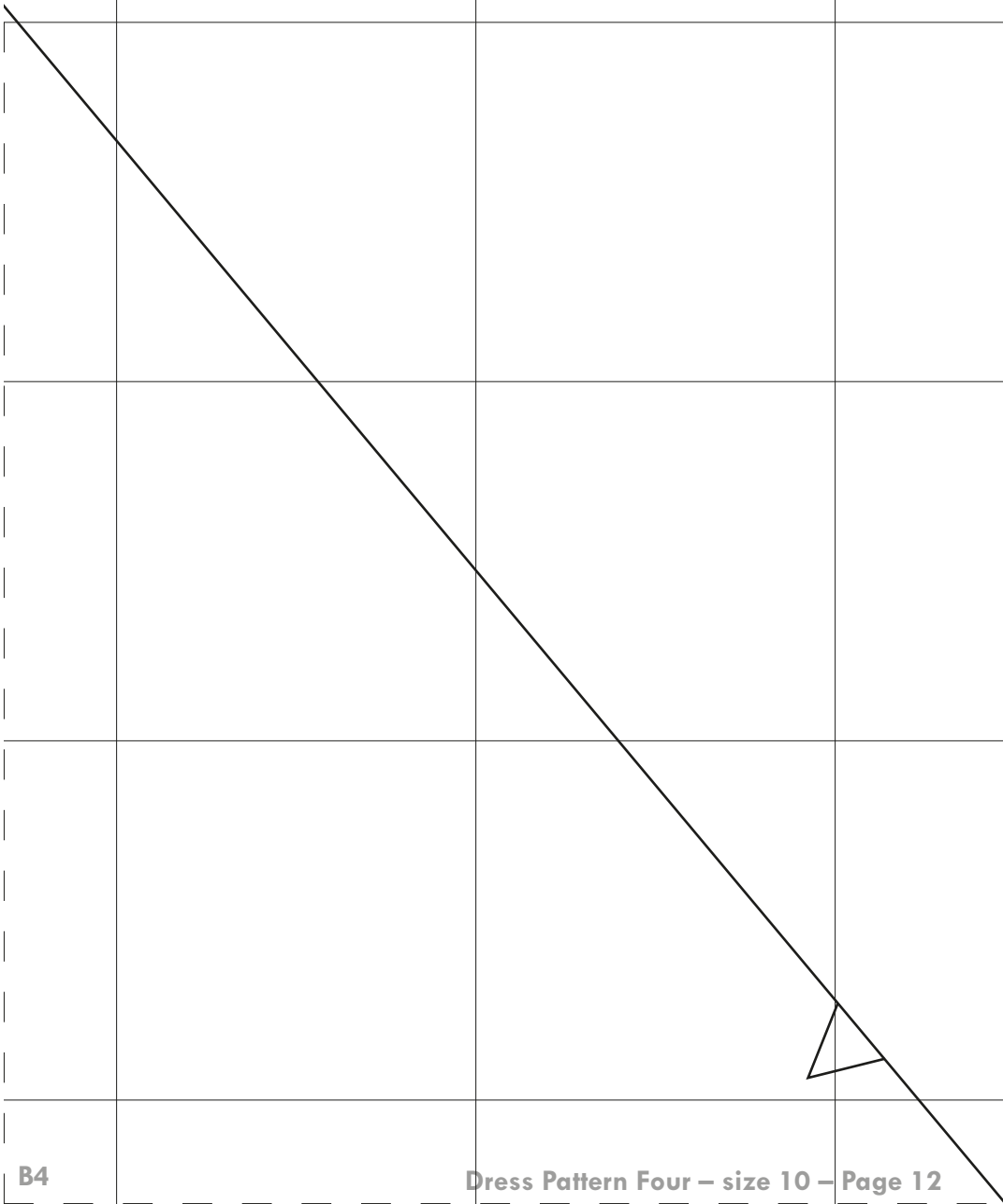

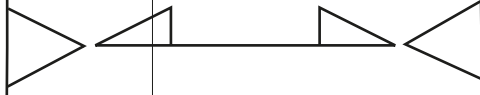

B6

B6

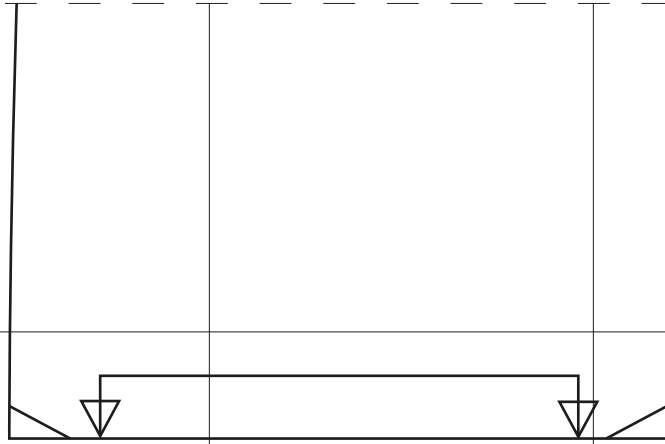

B6

B6

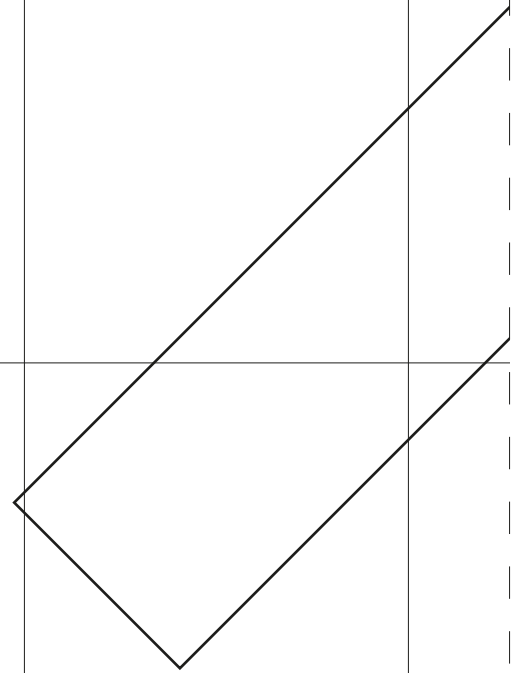

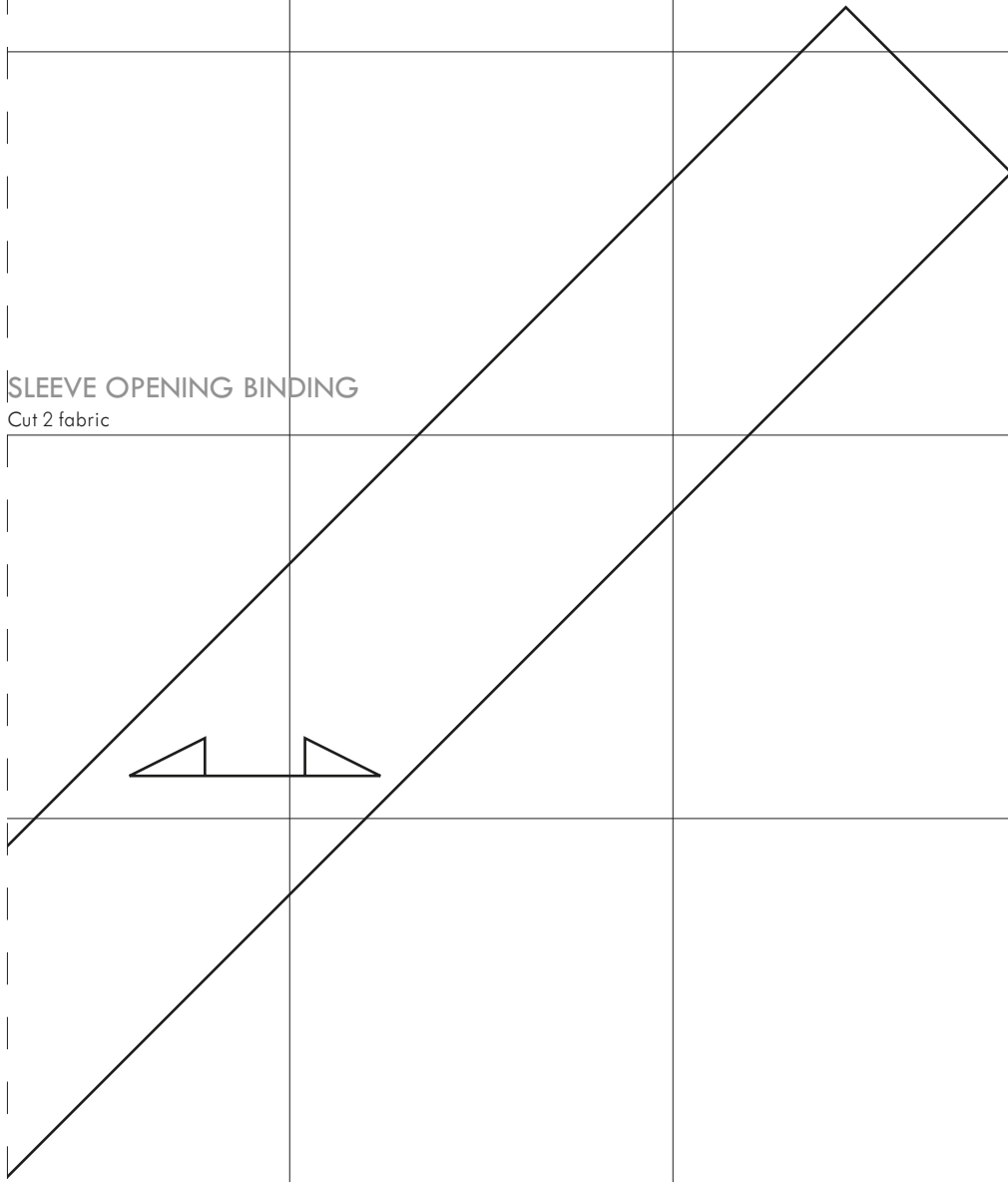

SLEEVE OPENING BINDING

Cut 2 fabric



C1

C1

C1

C1

C2

C2

C2

C2



C3

C3

C3

C3

C4

C4

C4

C4

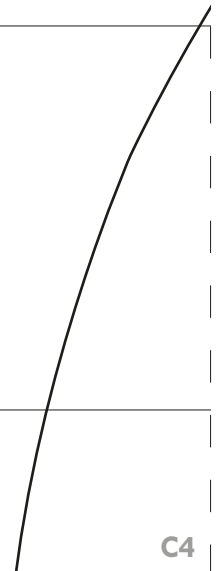
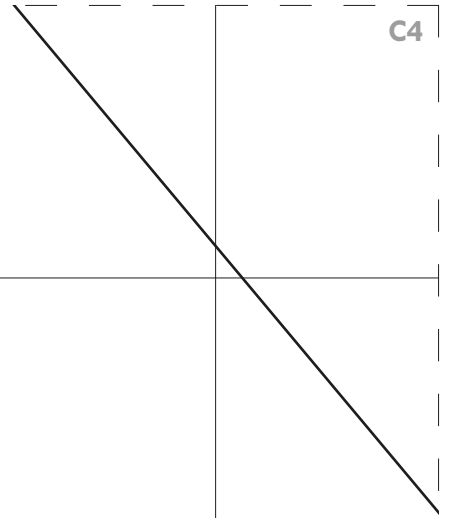

C5

C5

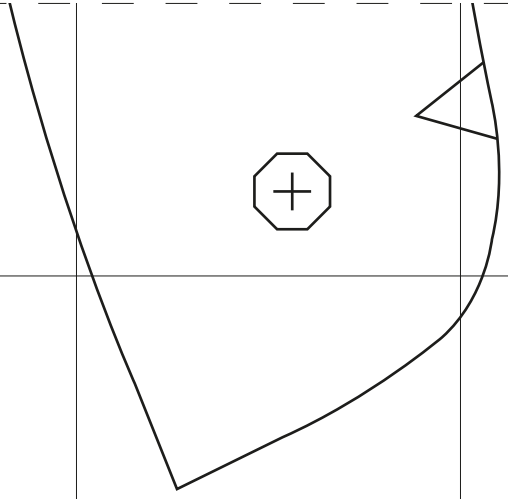
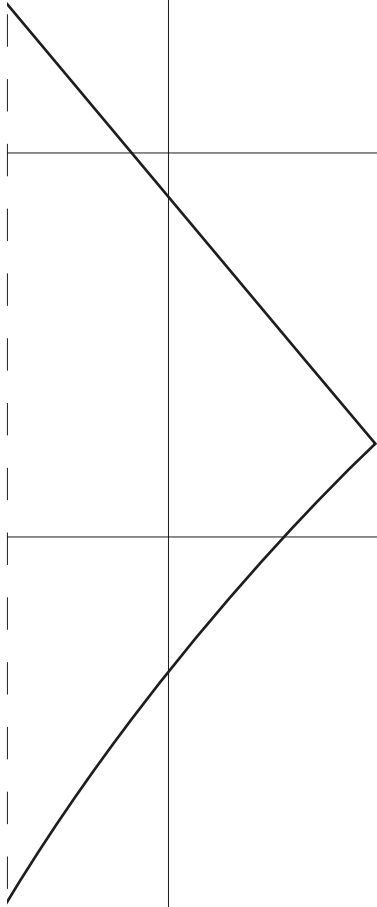

C5

C5

C6

C6

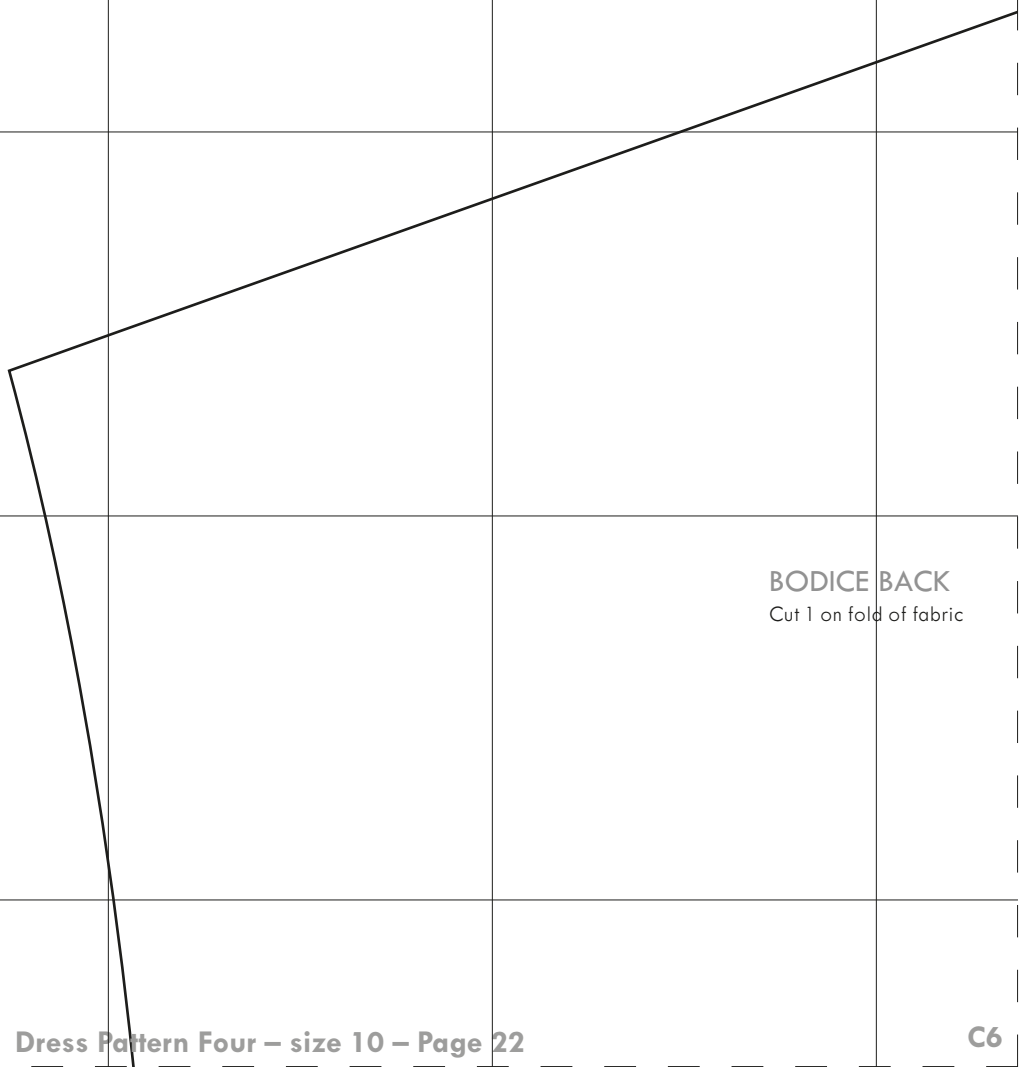

BODICE BACK  
Cut 1 on fold of fabric

C6

C6

C7

C7

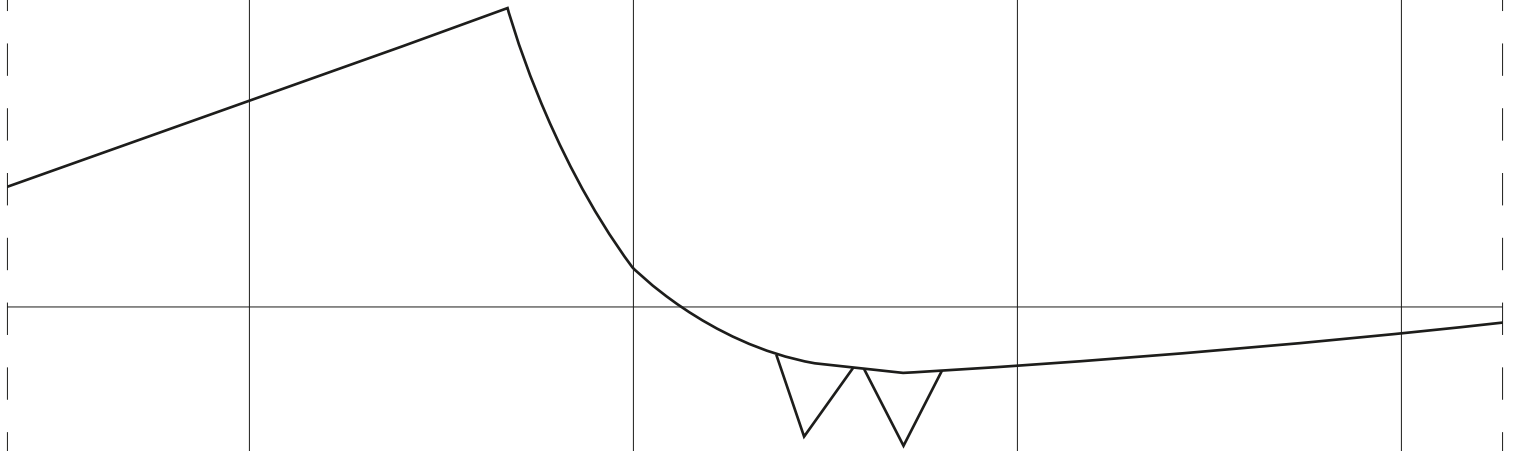

C7

C7

C8

C8

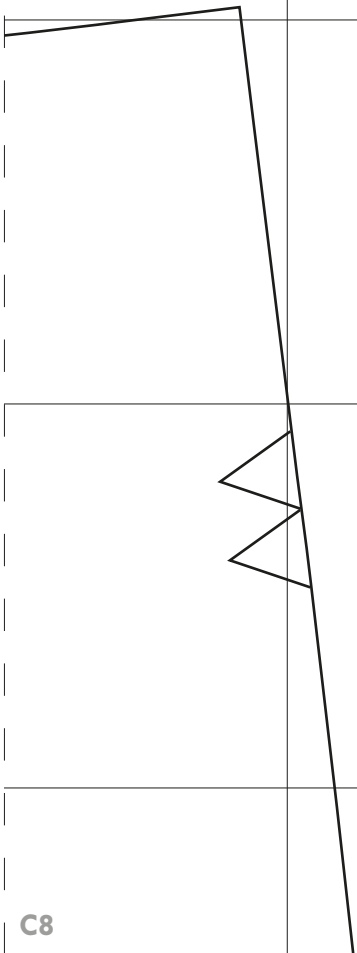

C8

C8



D1

D1

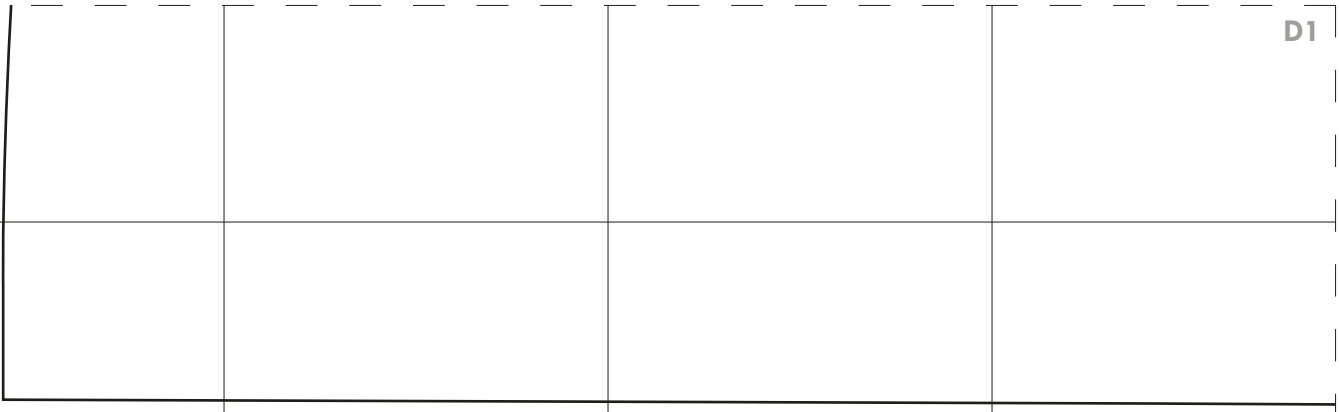

D1

D1

D2

D2

D2

D2

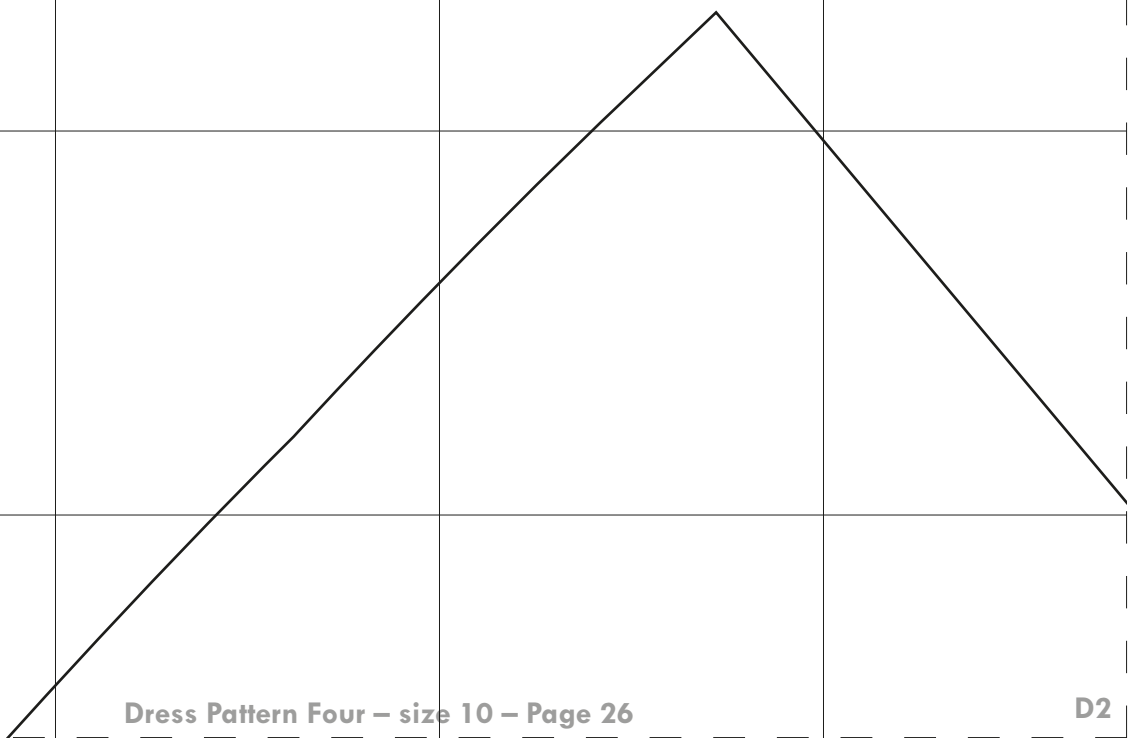

D3

D3



D3

D3

D4

D4

D4

D4

D5

D5

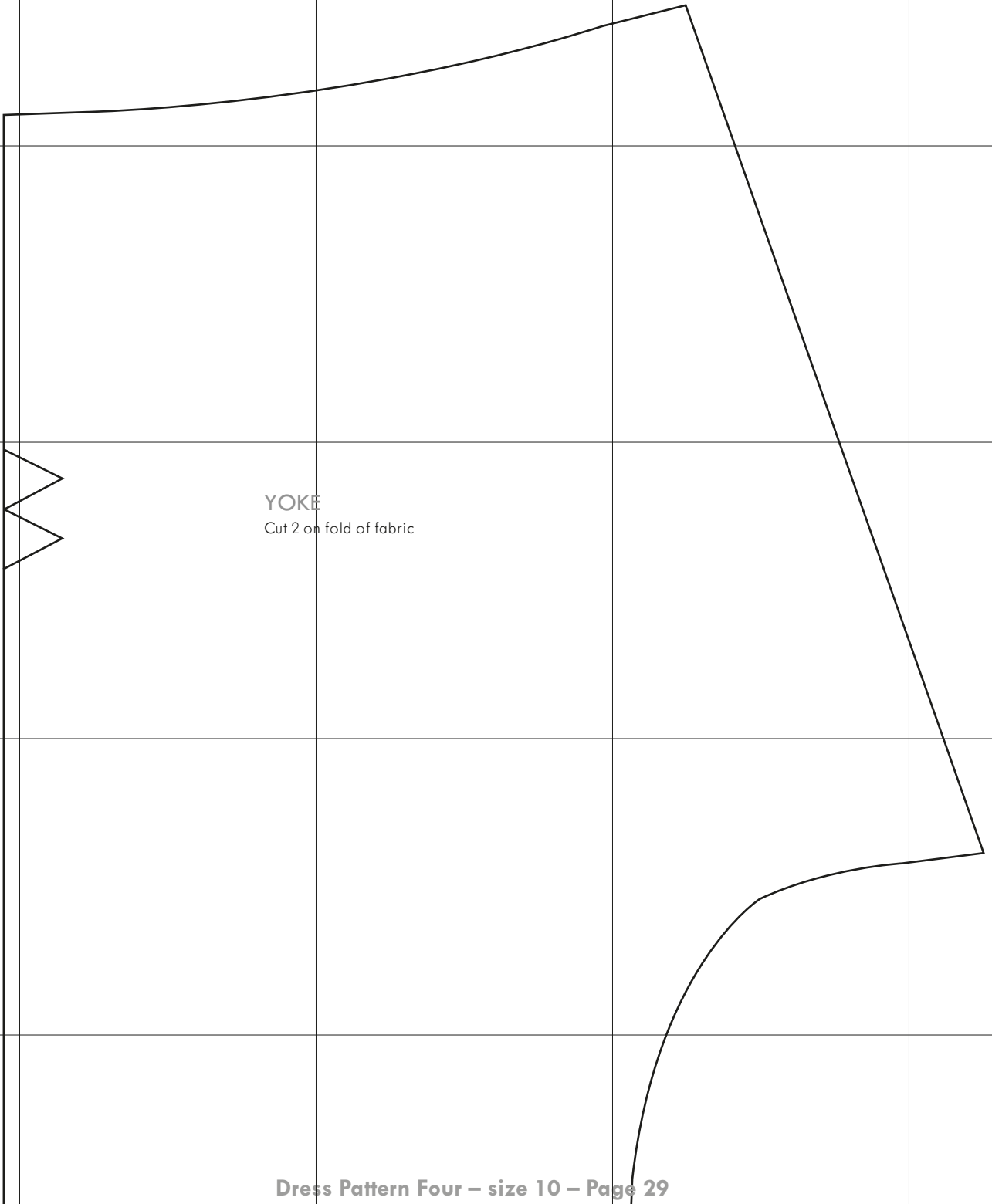

YOKE  
Cut 2 on fold of fabric

D5

D5

D6

D6

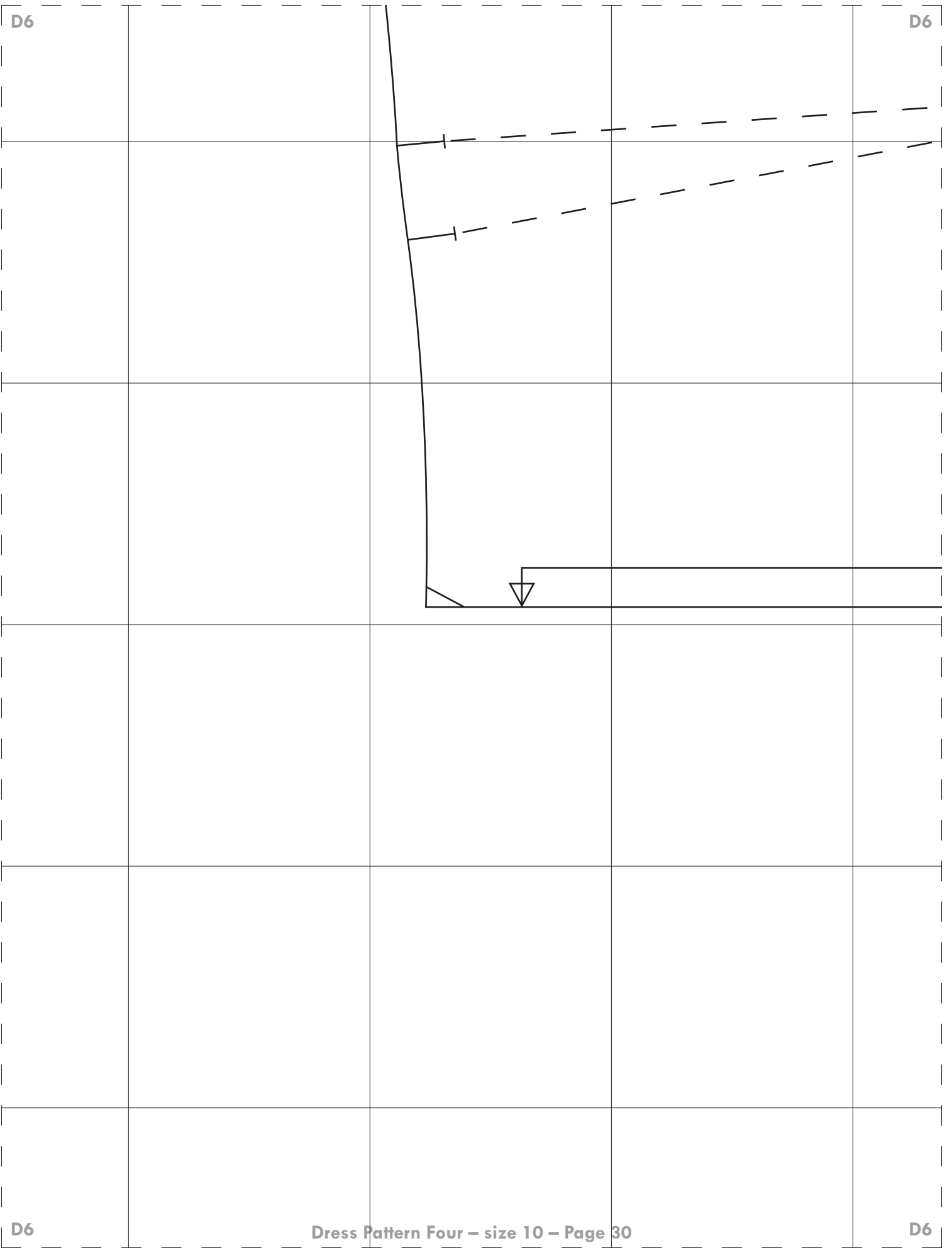

D6

D6

D7

D7

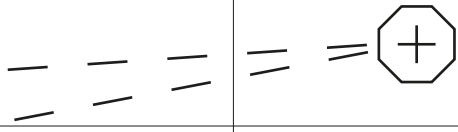

D7

D7

D8

D8

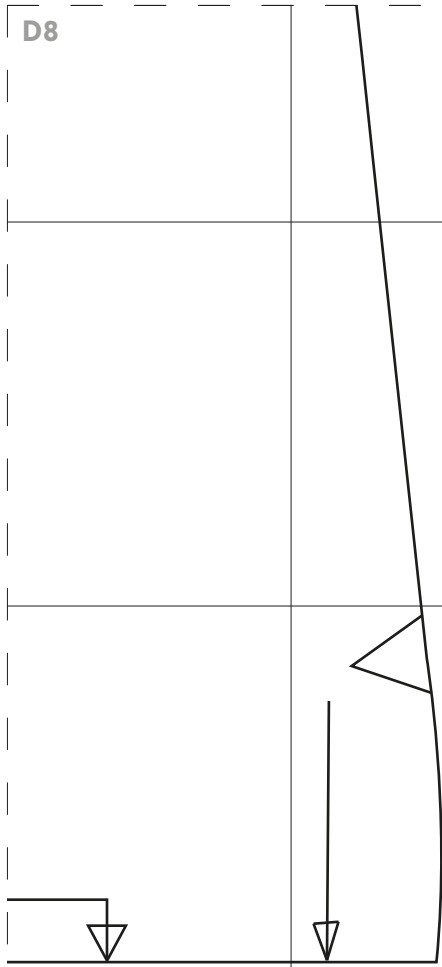

D8

D8



E1

E1

E1

E1

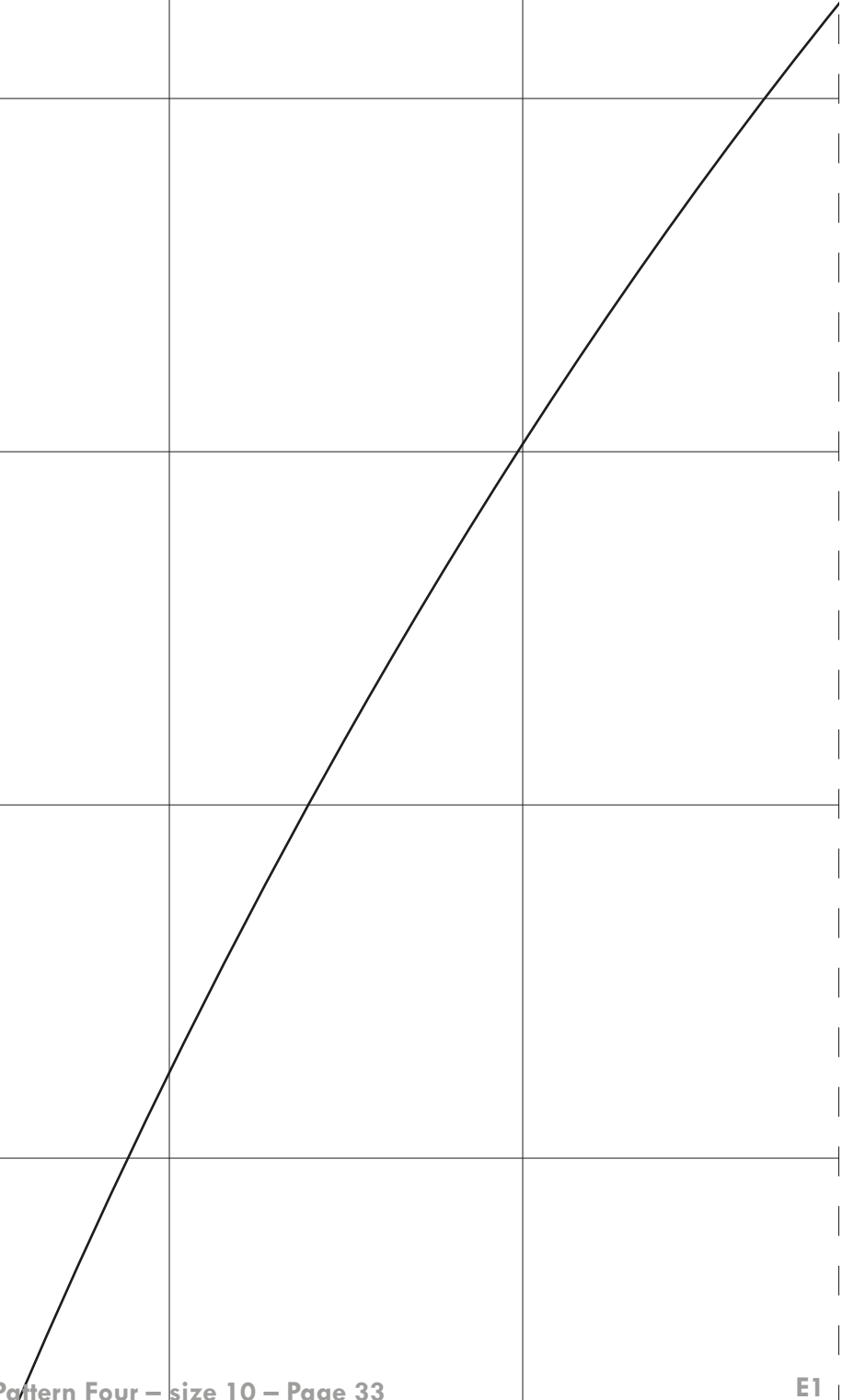

E2

E2

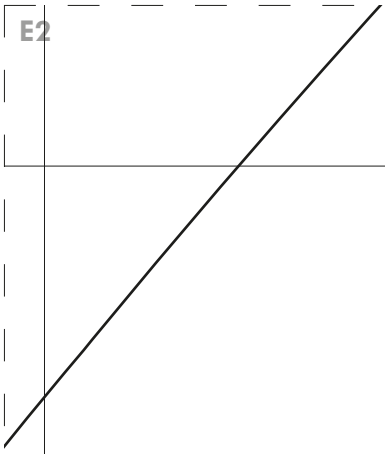

E2

E2

E3

E3

E3

E3

E4

E4

E4

E4

E5

E5

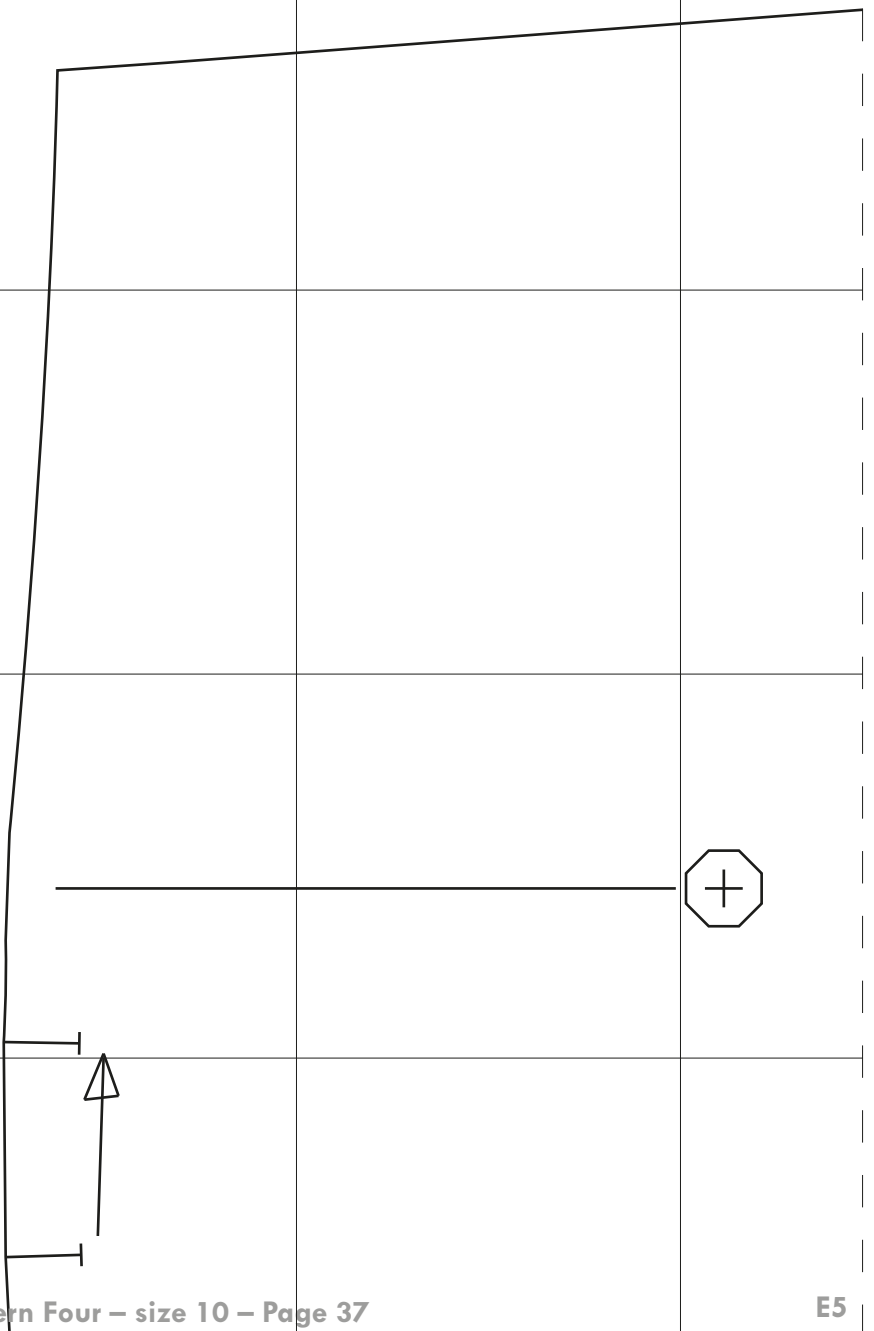
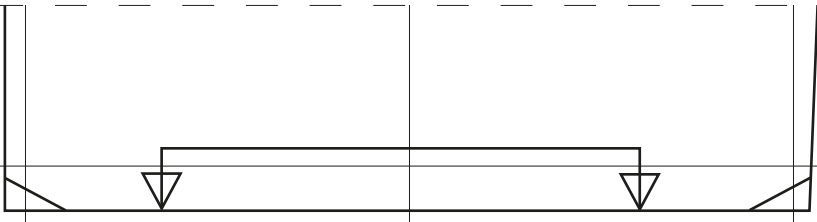

E5

E5

E6

E6

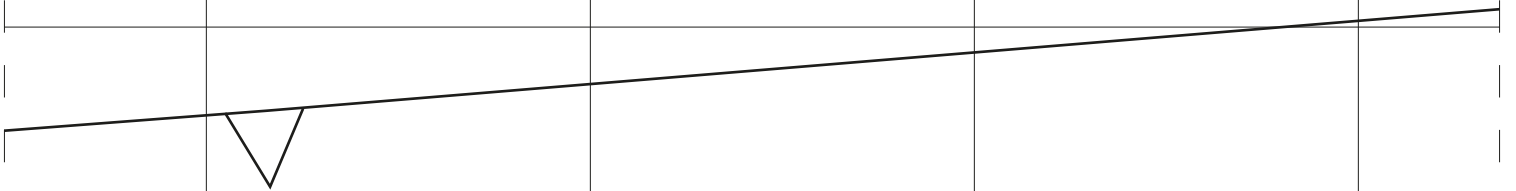

E6

E6

E7

E7

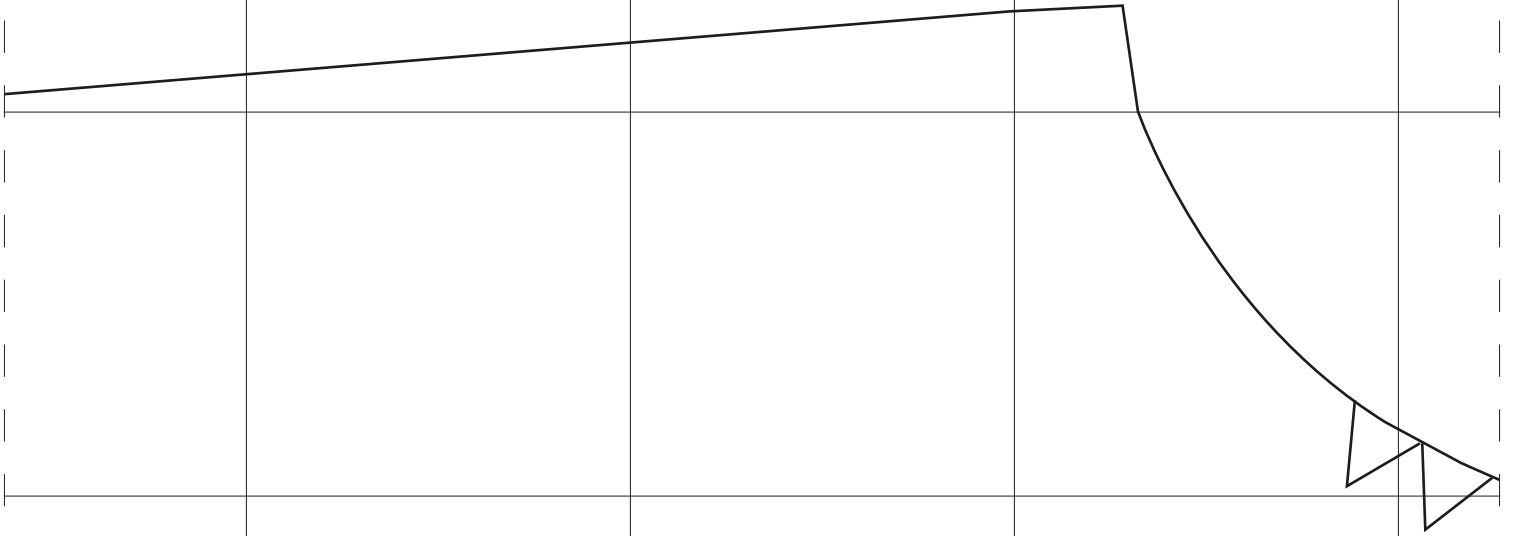

E7

E7

E8

E8

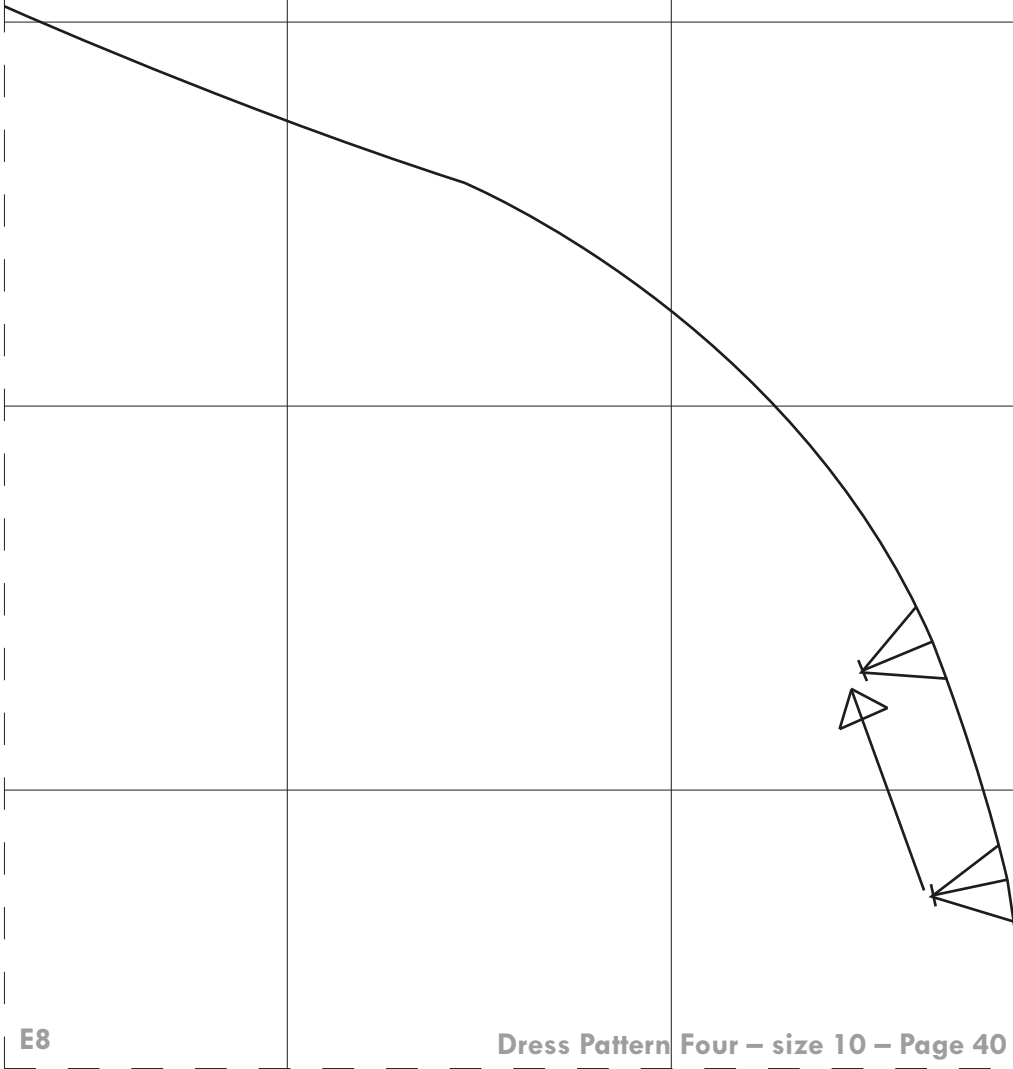

E8

E8



F1

F1

F1

F1

F2

F2

F2

F2

F3

F3

SKIRT BACK  
Cut 1 on fold of fabric

F3

F3

F4

F4



F4

F4

F5

F5

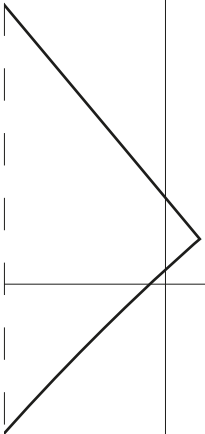
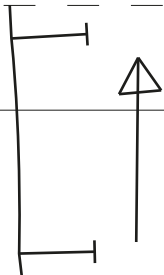

F5

F5

F6

F6



SLEEVE  
Cut 2 fabric



F6

F6

F7

F7

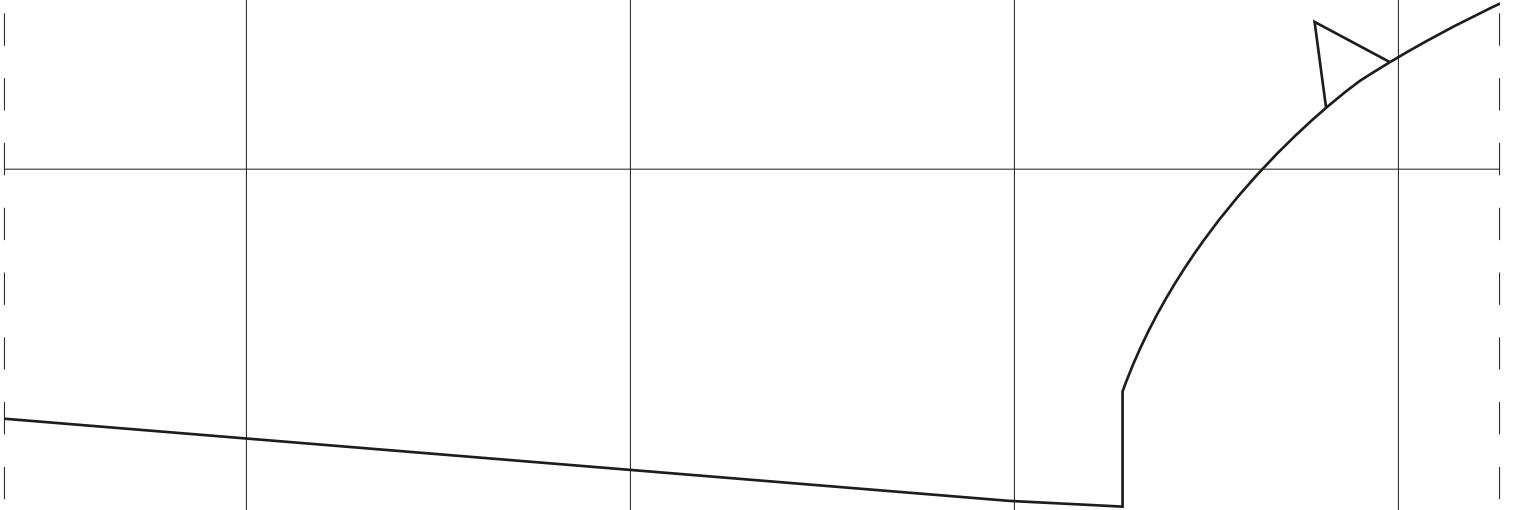
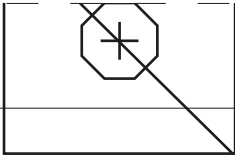

F7

F7

F8

F8

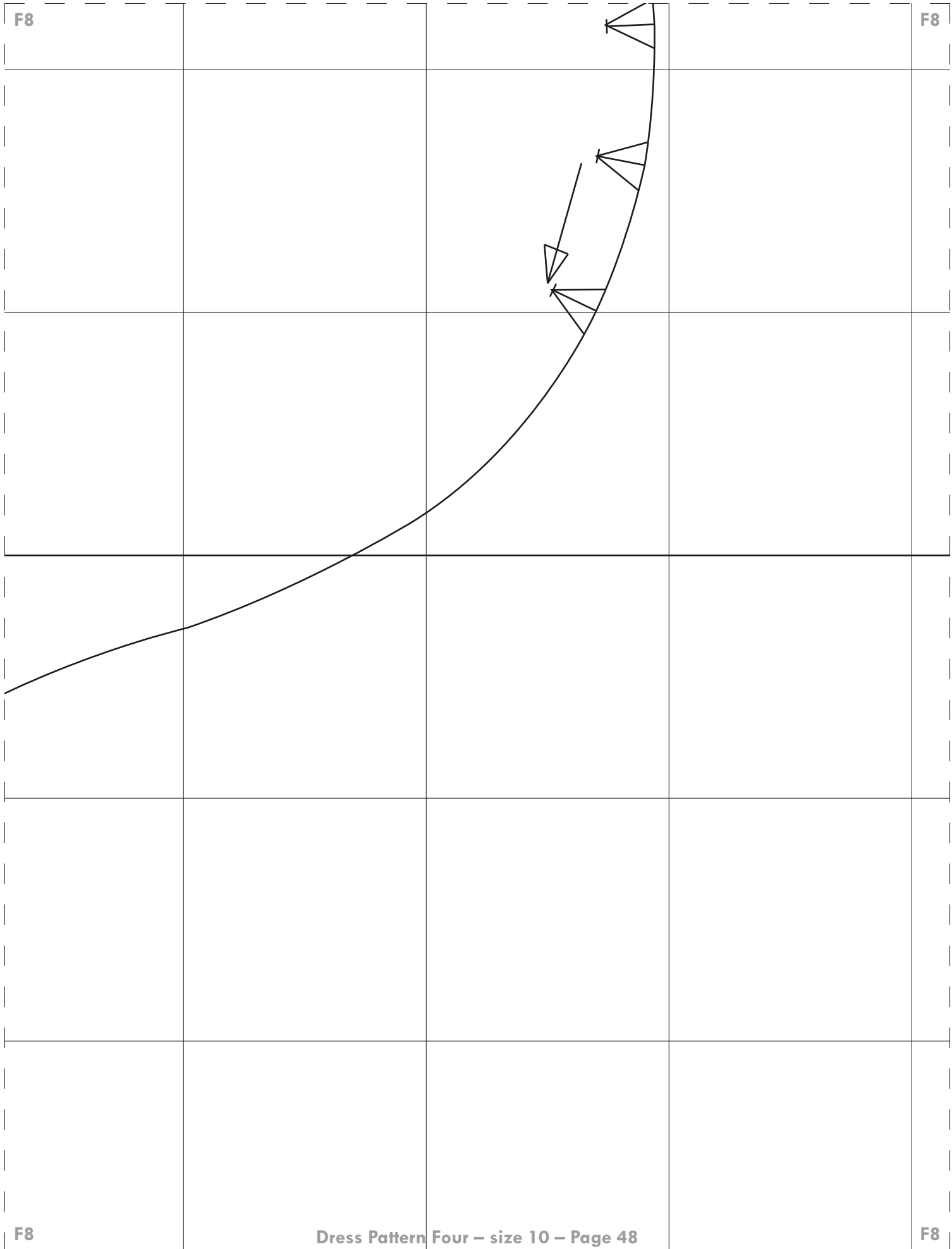

F8

F8



G1

G1

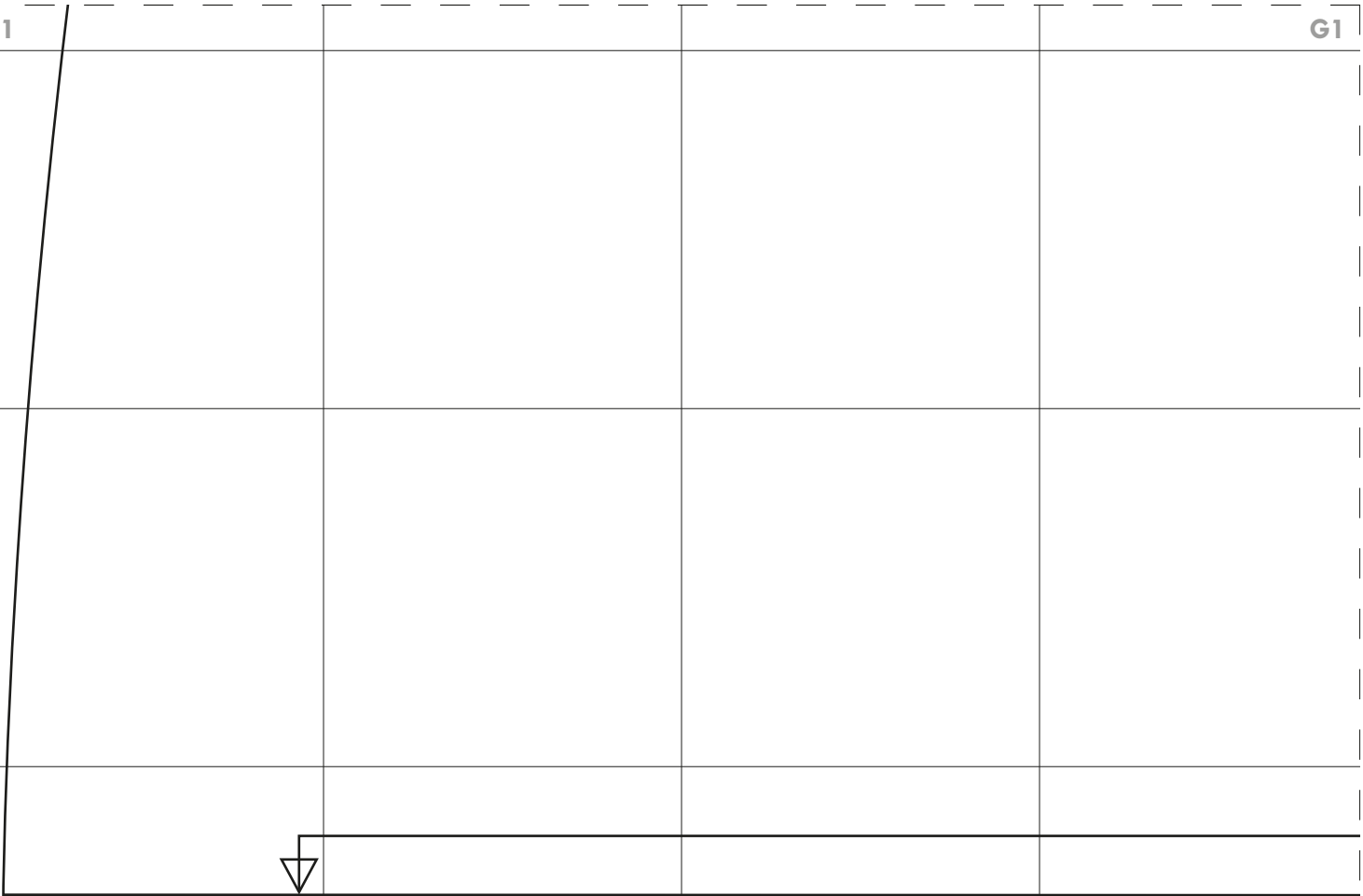

G1

G1

G2

G2

G2

G2

G3

G3

G3

G3

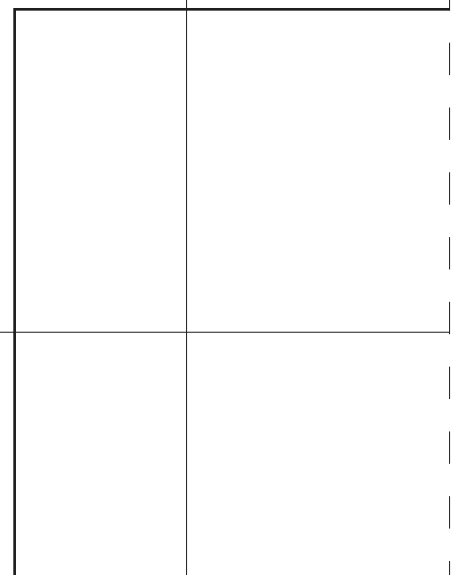

G4

G4

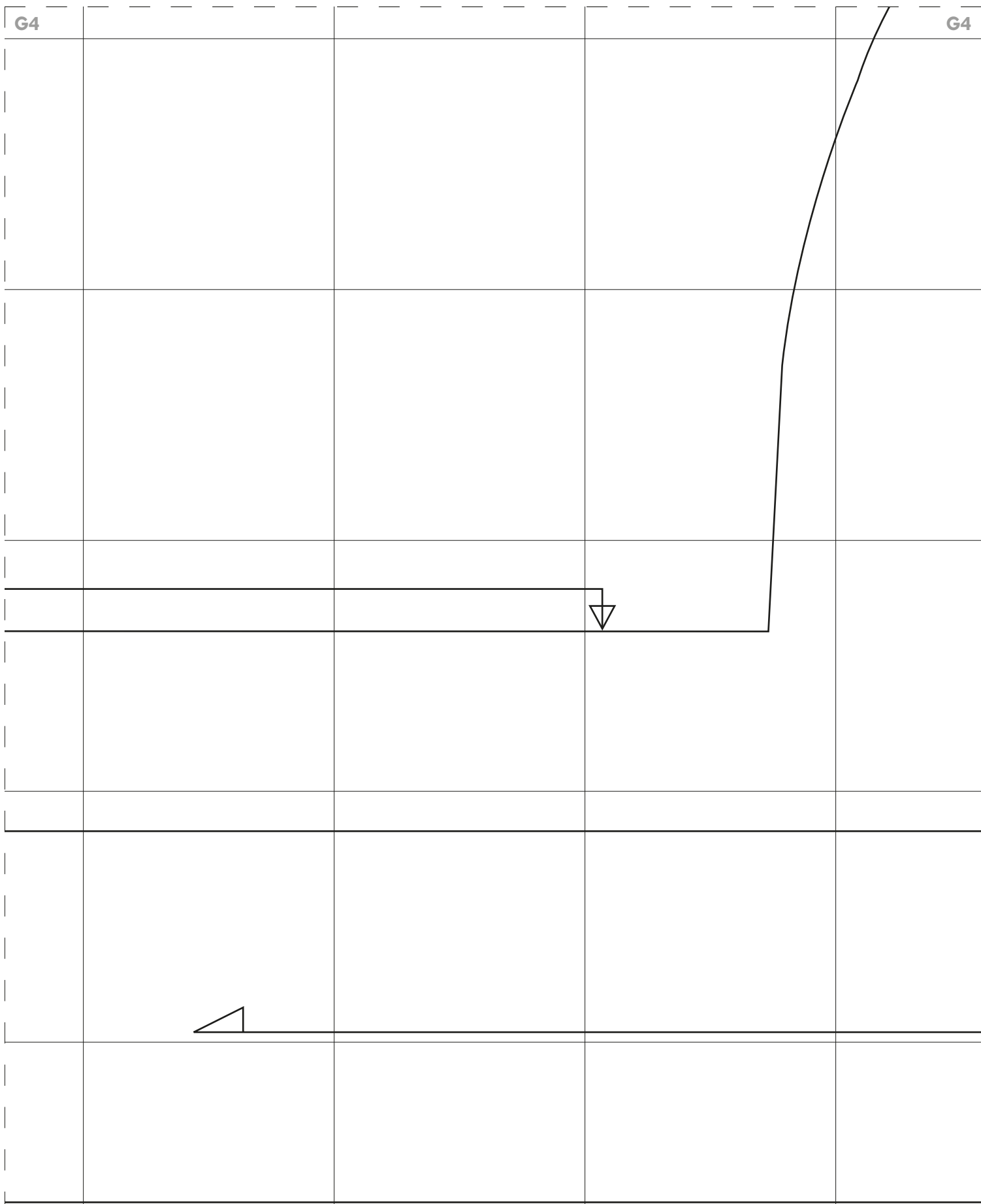

SLEEVE TAB FOR VARIATION

Cut 2 fabric  
Cut 2 interfacing

G4

G4

G5

G5

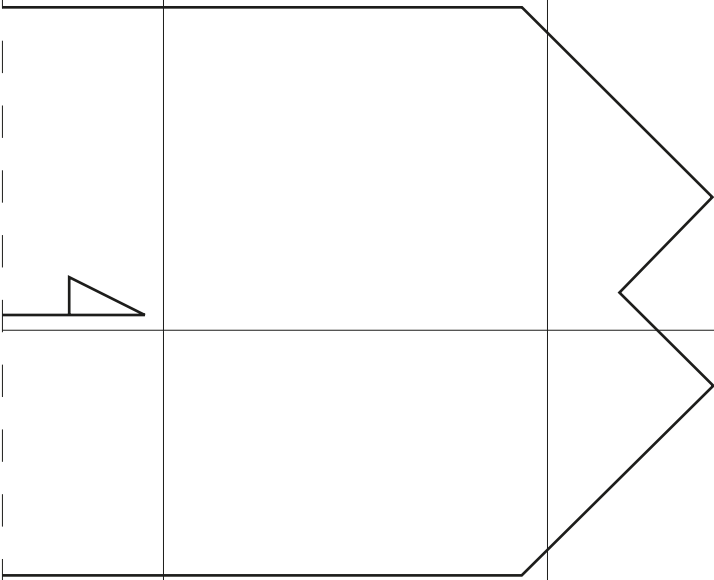

G5

G5

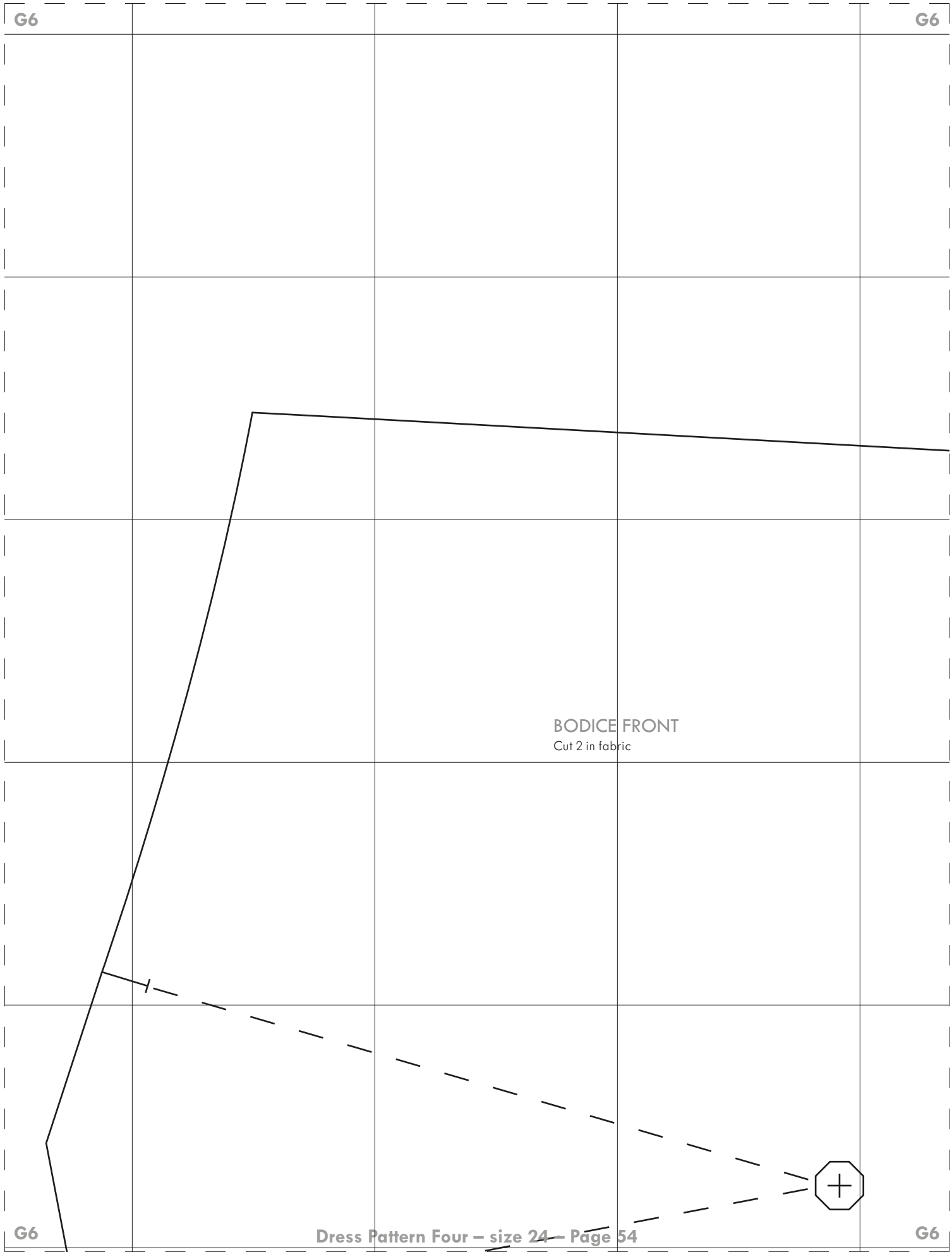

BODICE FRONT

Cut 2 in fabric

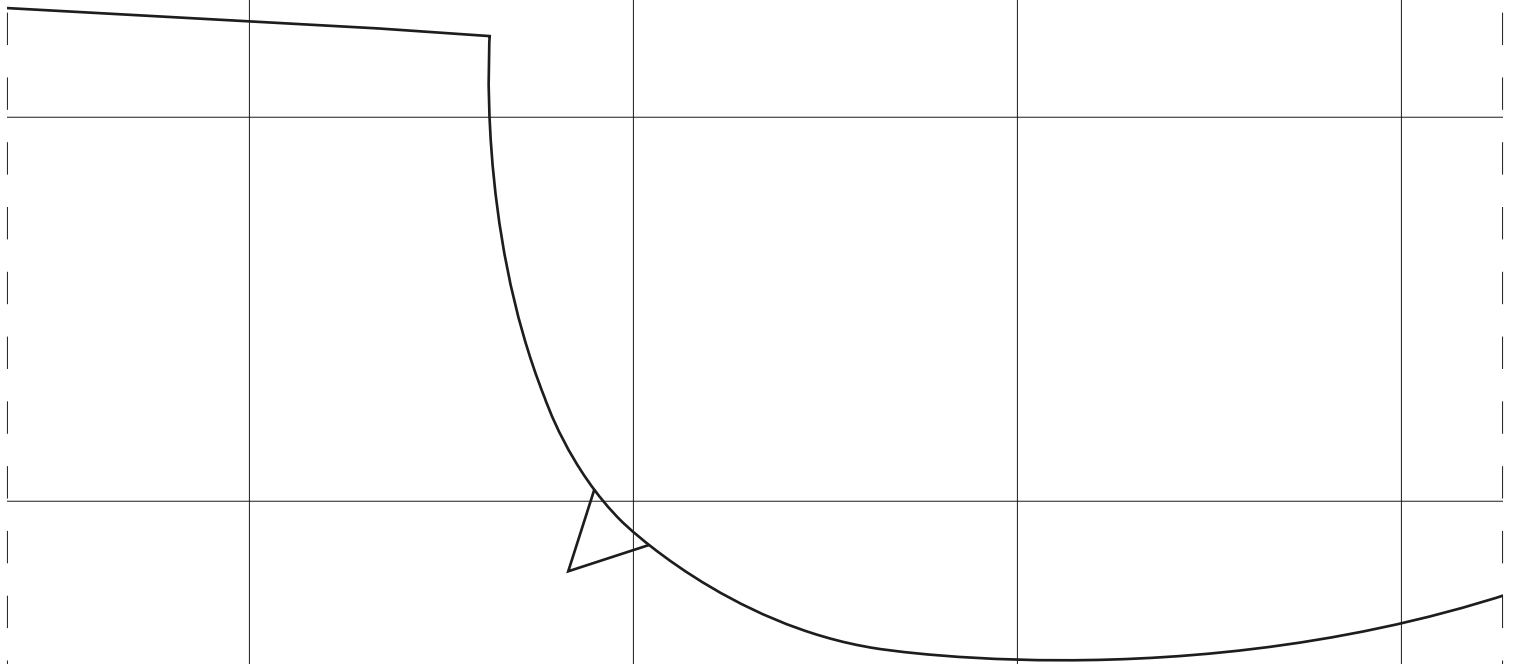

G8

G8

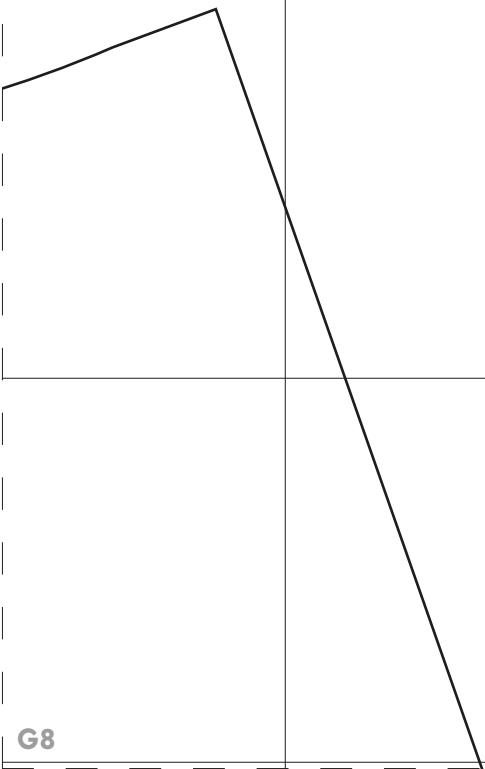

G8

G8



H1

H1

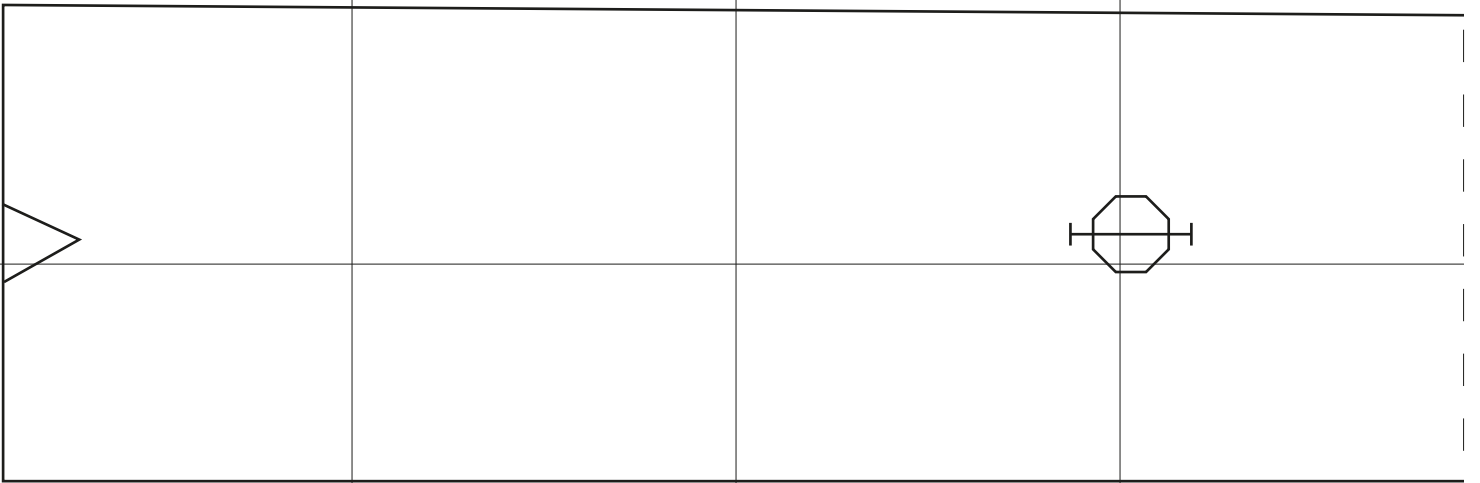

H1

H1

H2

H2

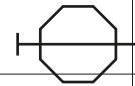

H2

H2

H3

H3

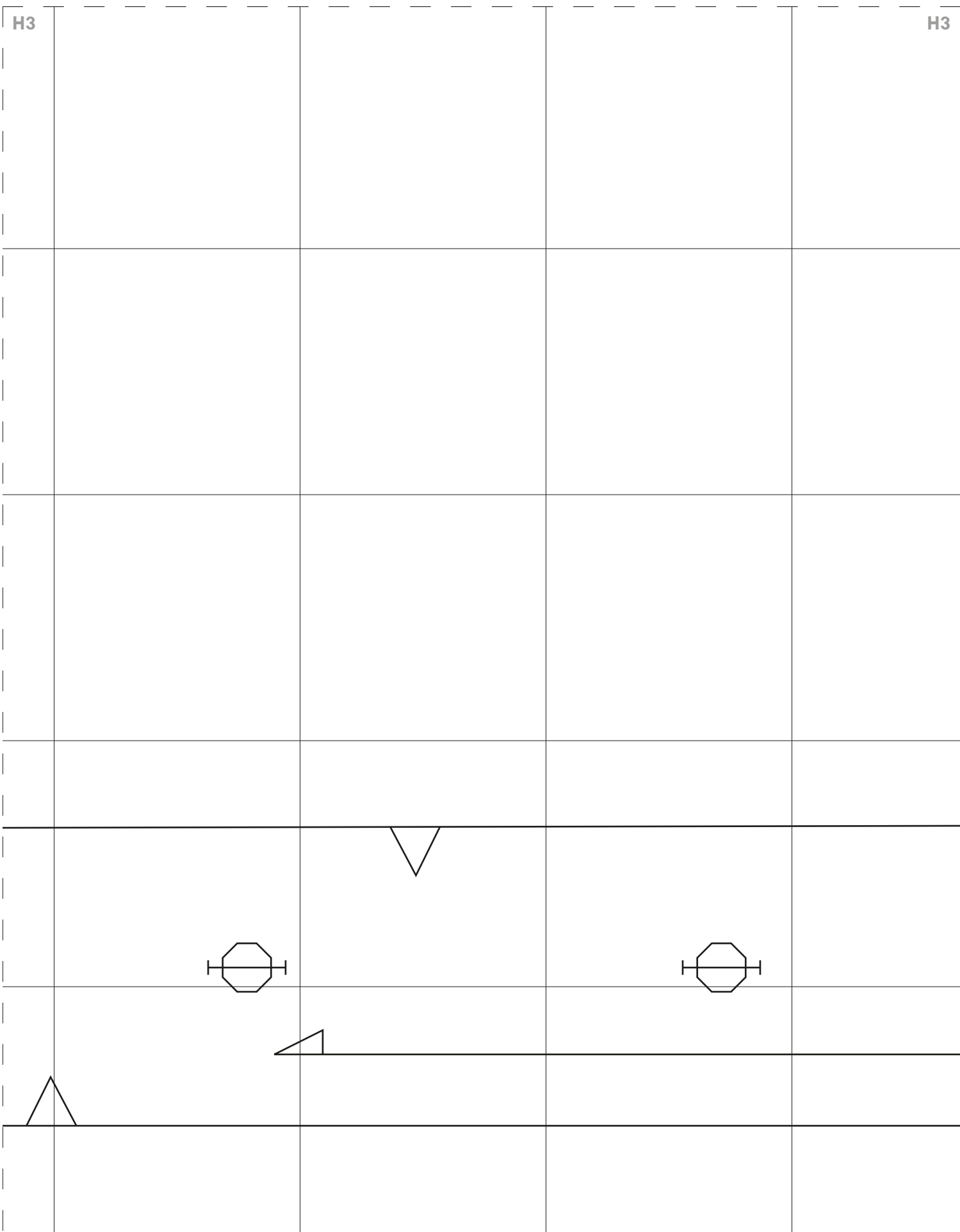

H3

H3

H4

H4

FRONT BUTTON PLACKET

Cut 4 fabric  
Cut 2 interfacing

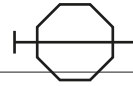
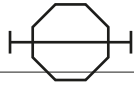

H4

H4

H5

H5

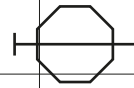
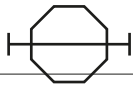

H5

H5

H6

H6

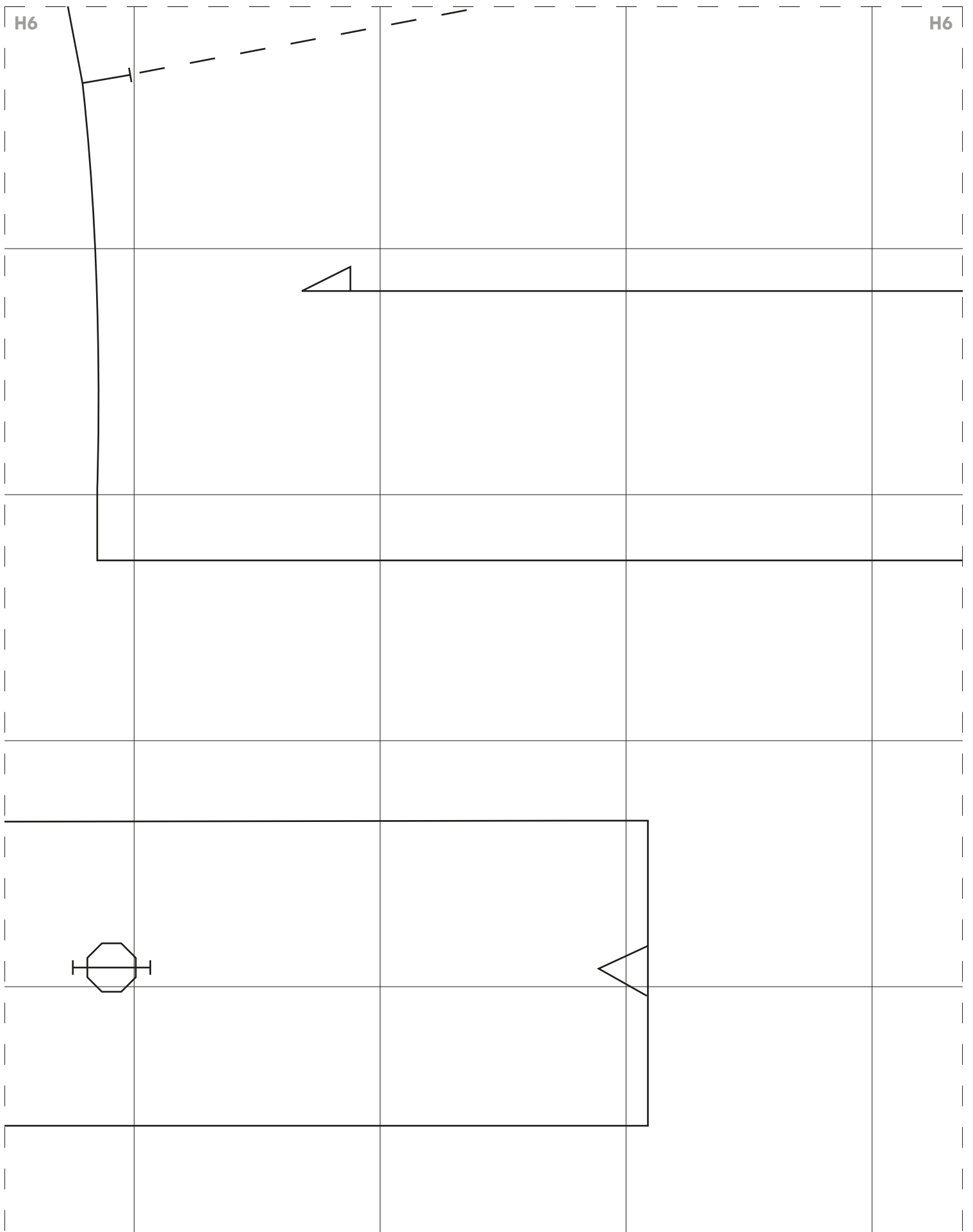

H6

H6

H7

H7



H7

H7

H8

H8

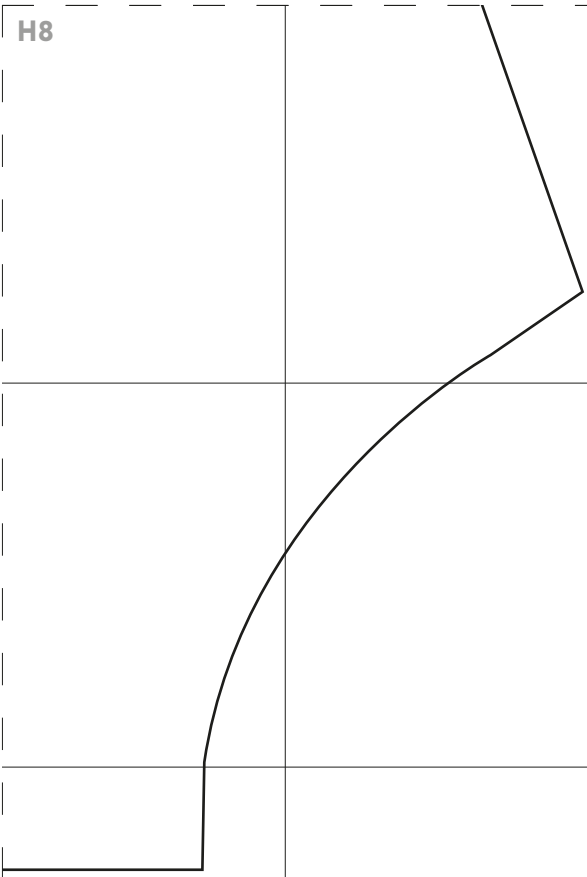

H8

H8