

A1

A1

A1

A1

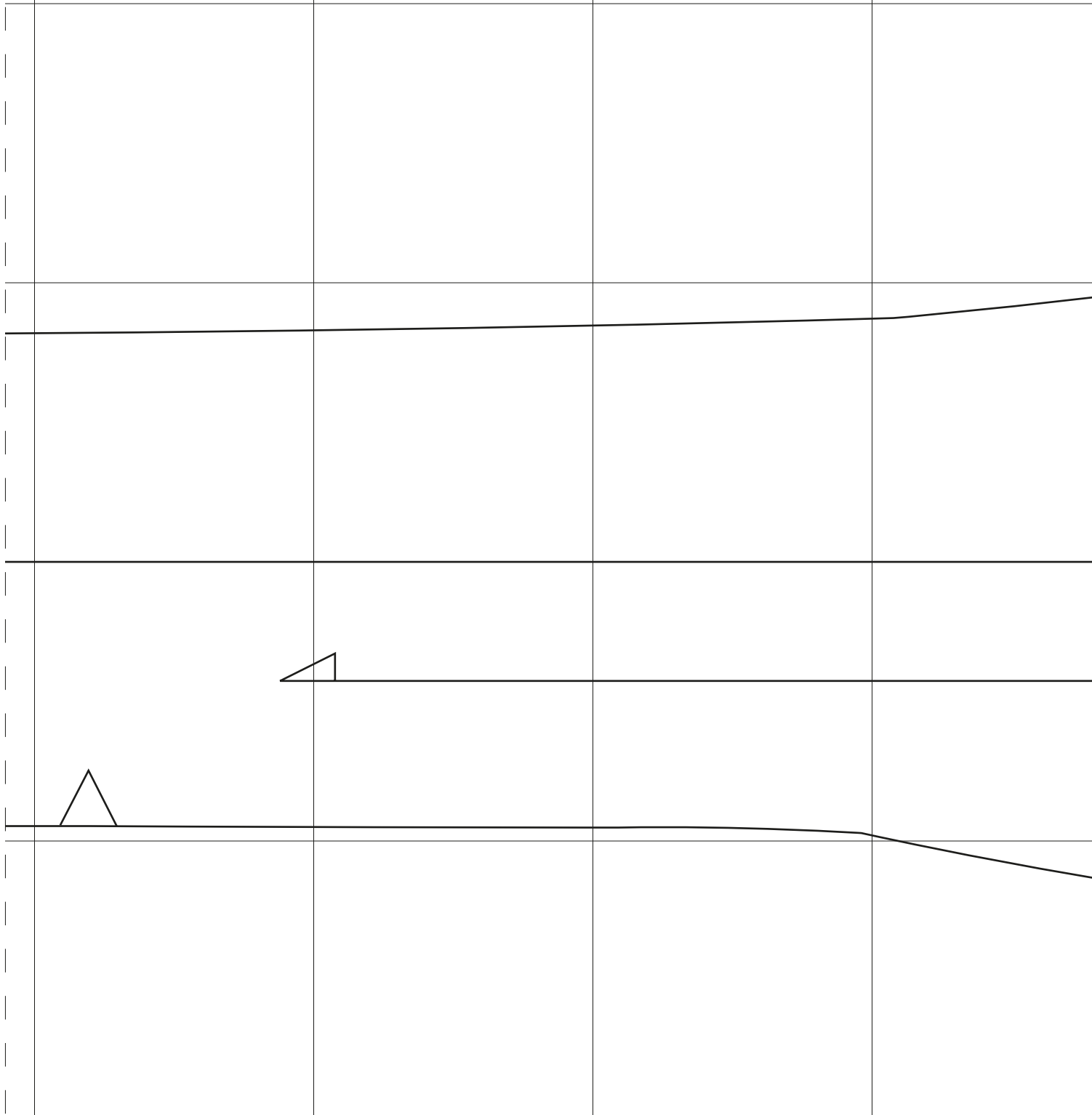

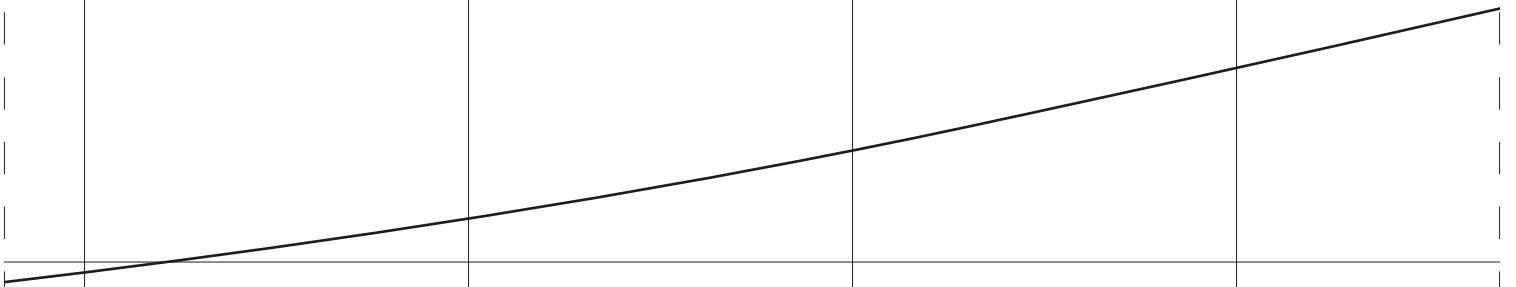

FRONT FACING
Cut 2 fabric

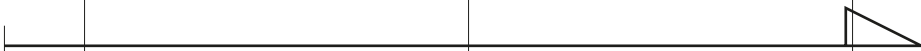

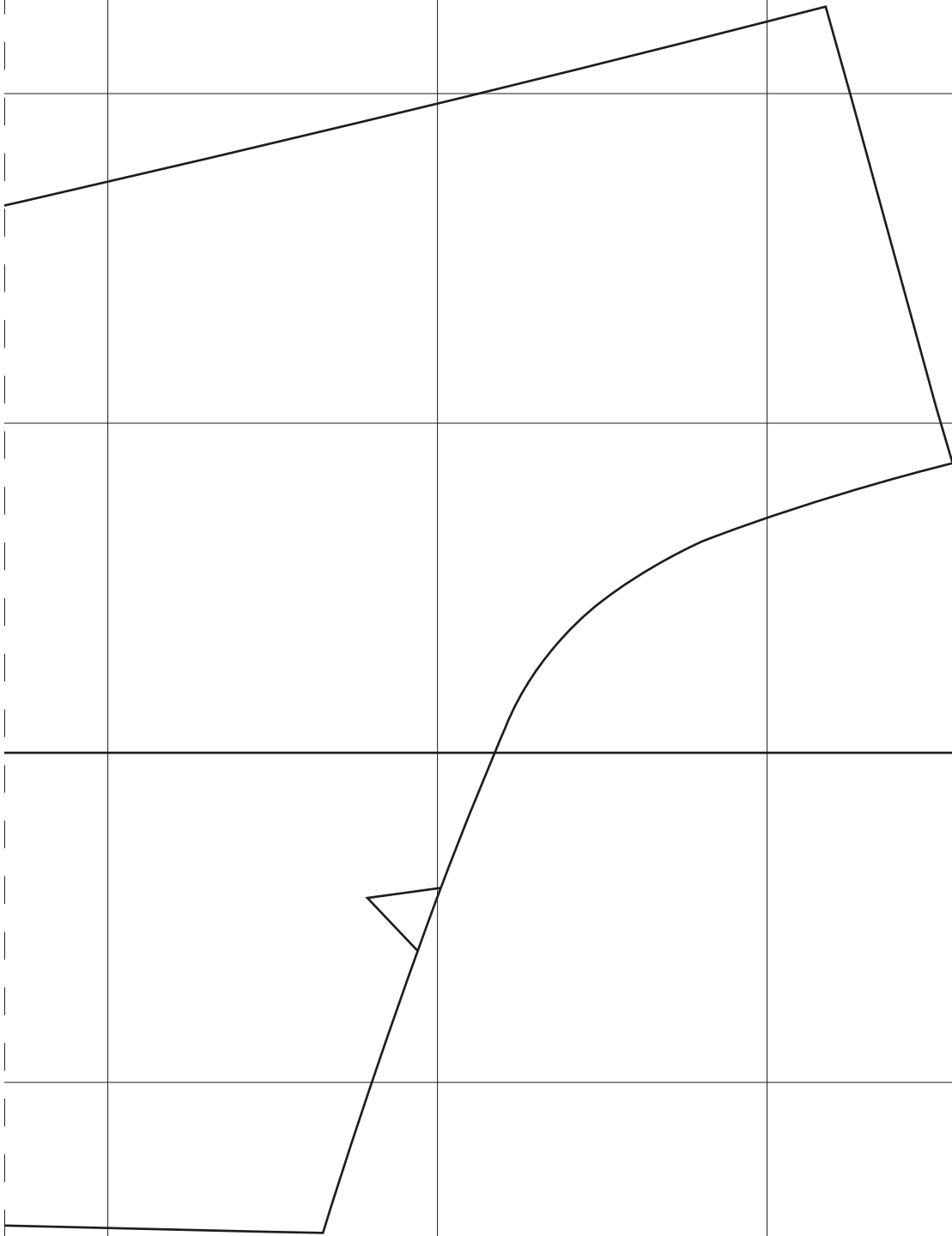

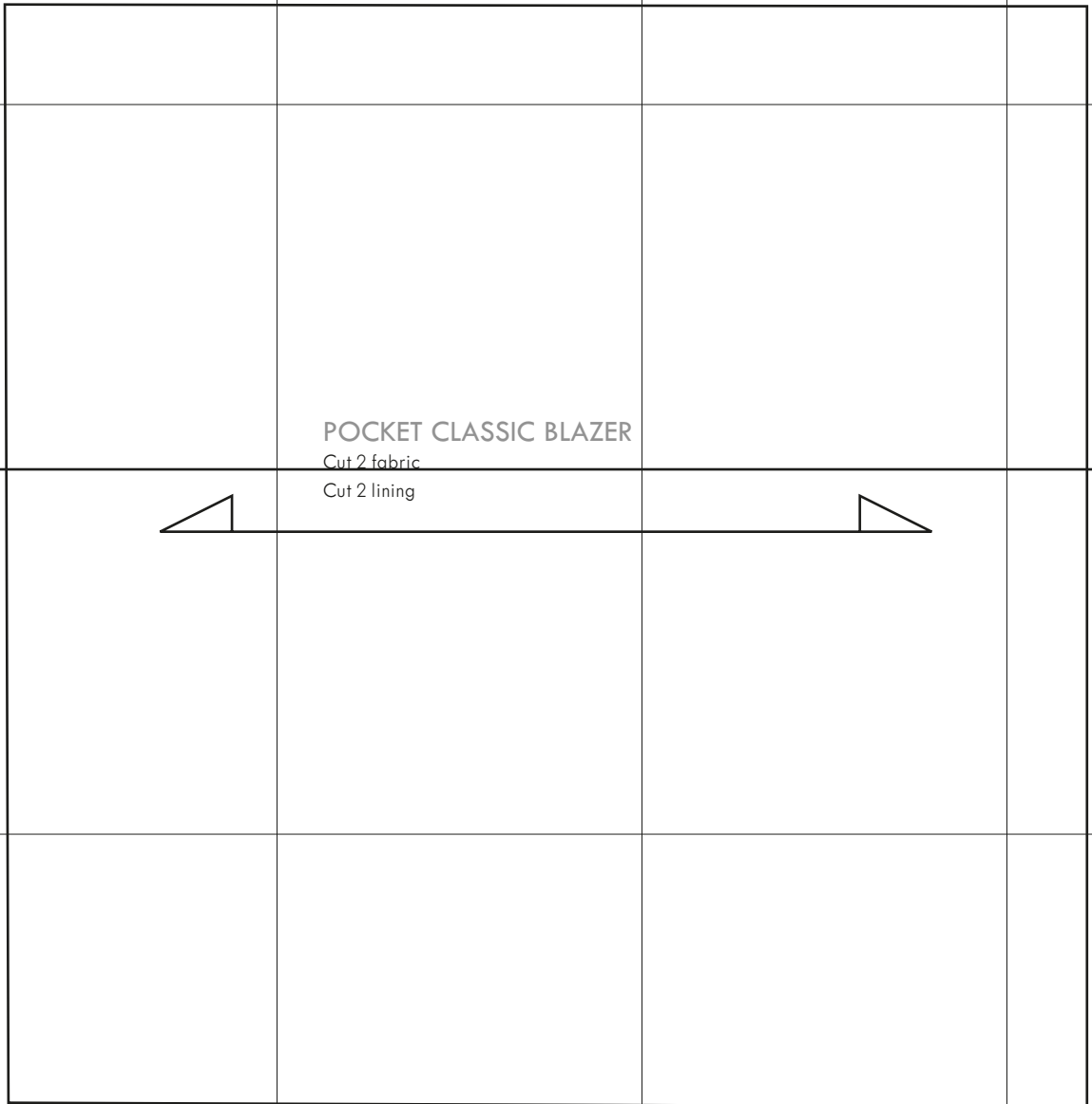

POCKET CLASSIC BLAZER

Cut 2 fabric

Cut 2 lining



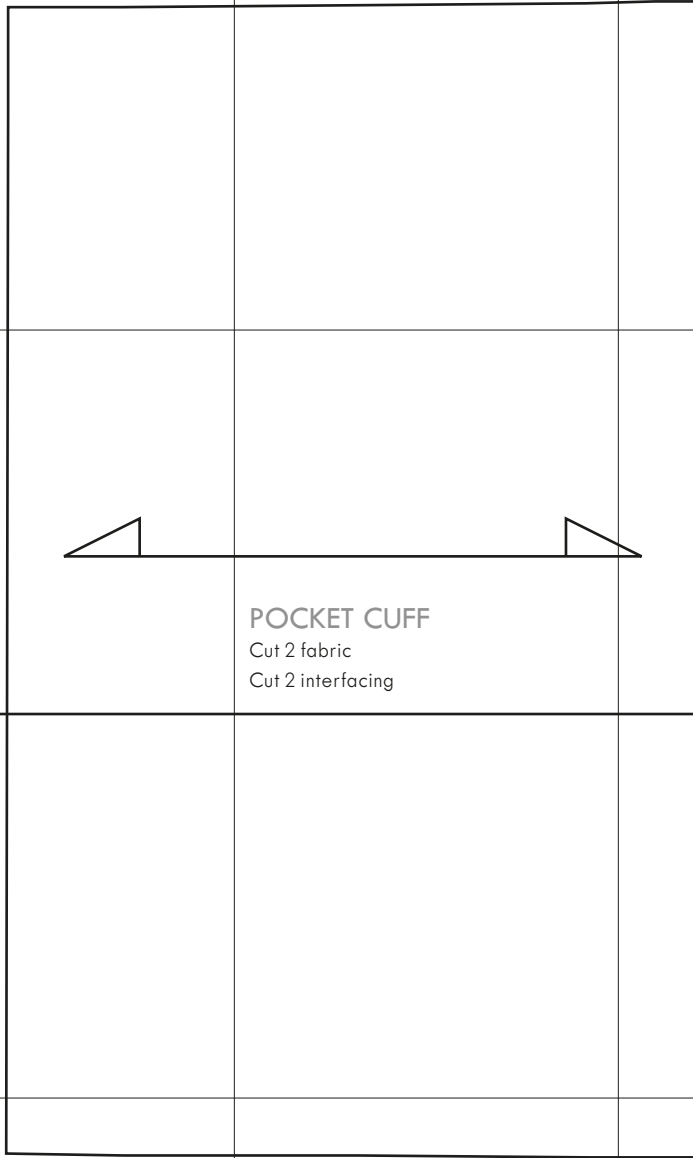

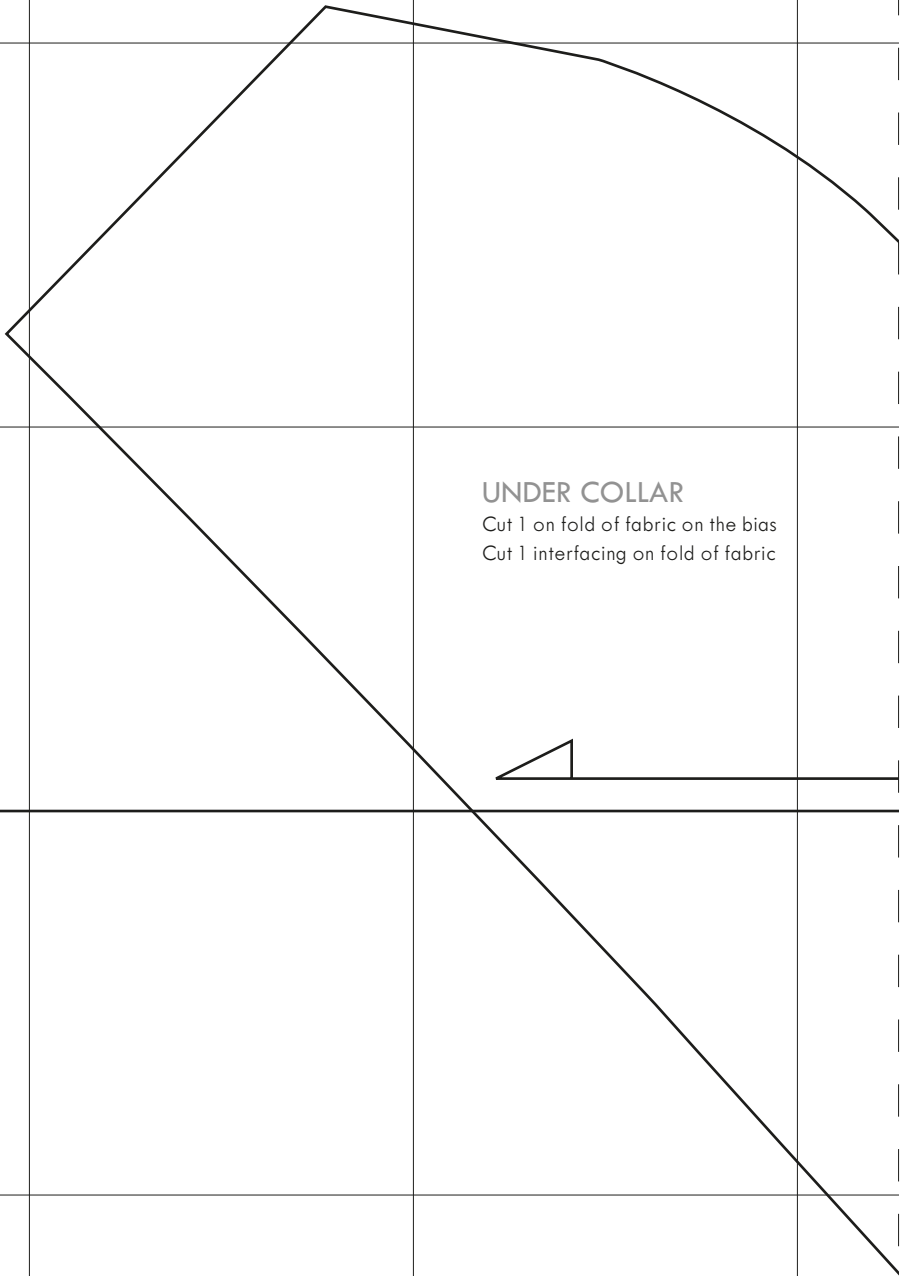

UNDER COLLAR

Cut 1 on fold of fabric on the bias
Cut 1 interfacing on fold of fabric

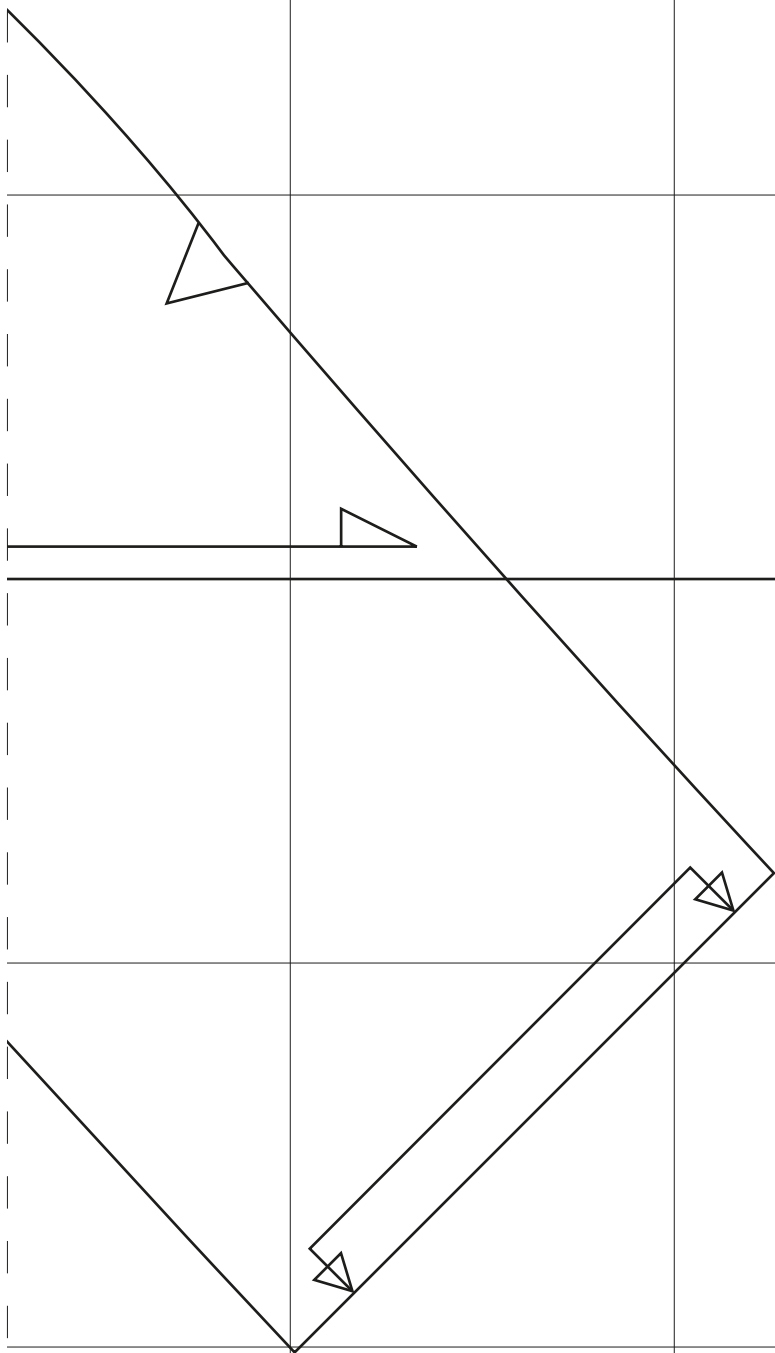

B1

B1

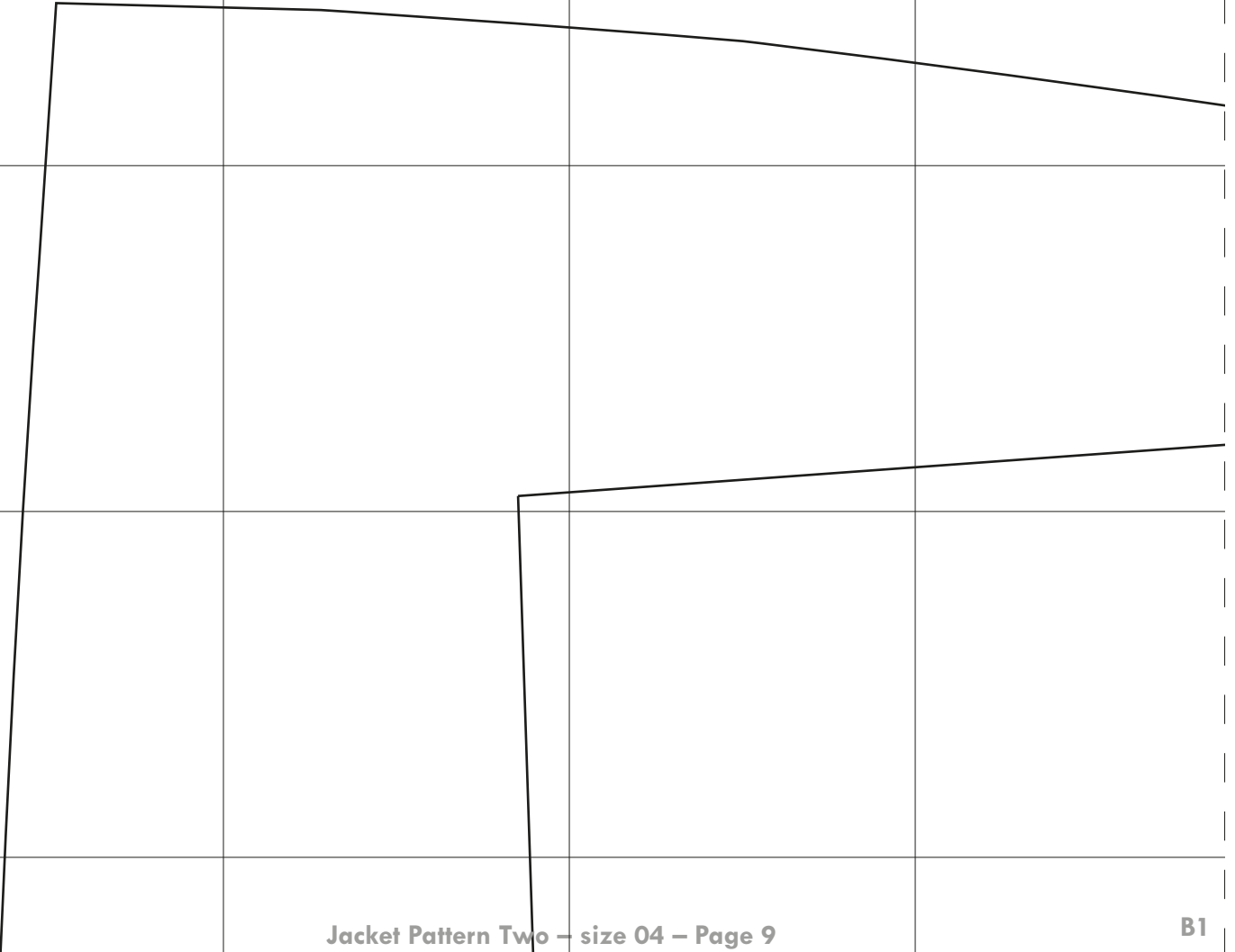

B1

B1

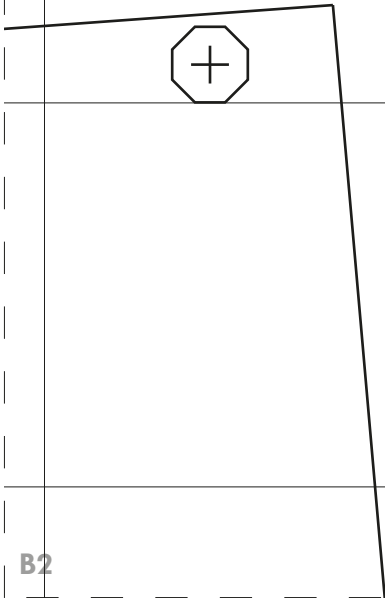
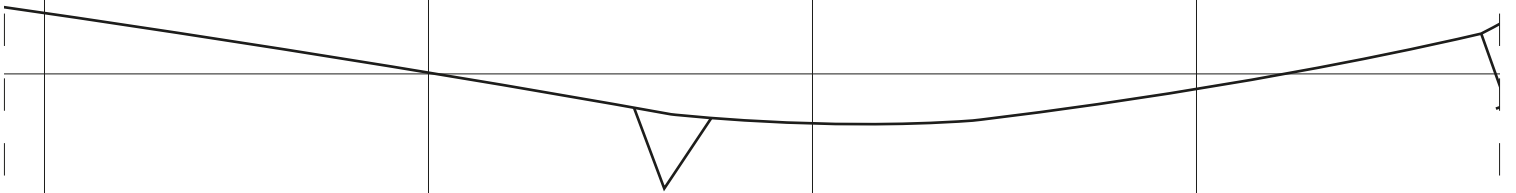

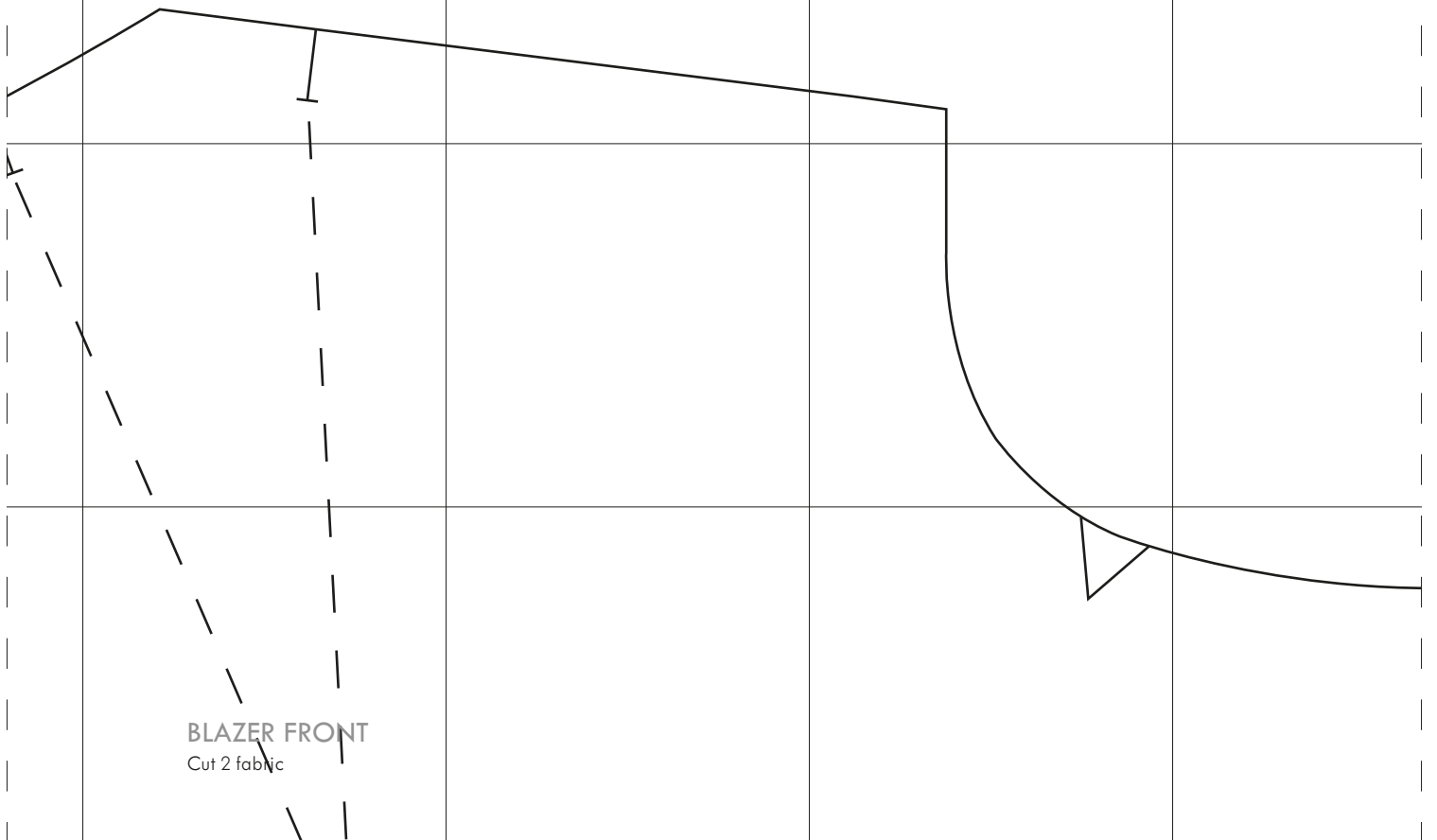

BLAZER FRONT
Cut 2 fabric



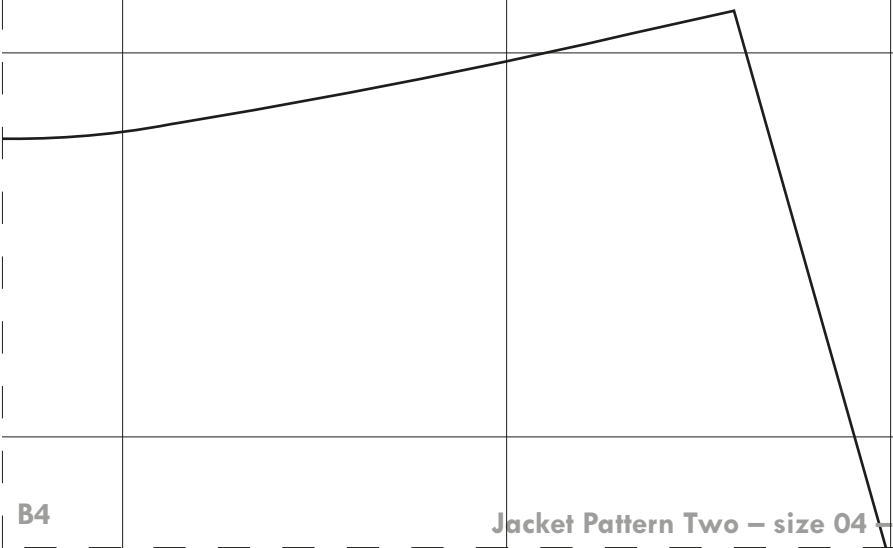

B5

B5

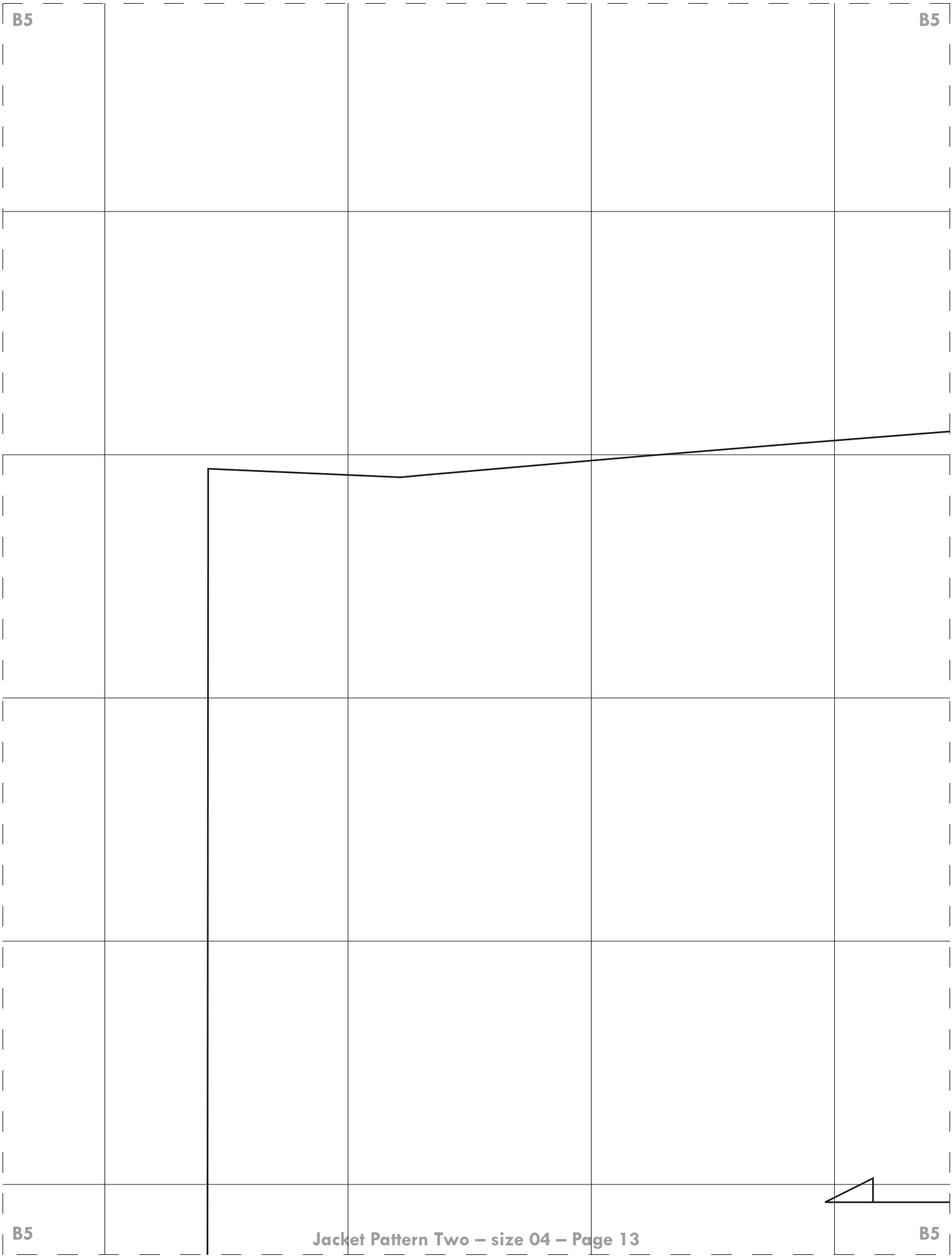

B5

B5

B6

B6

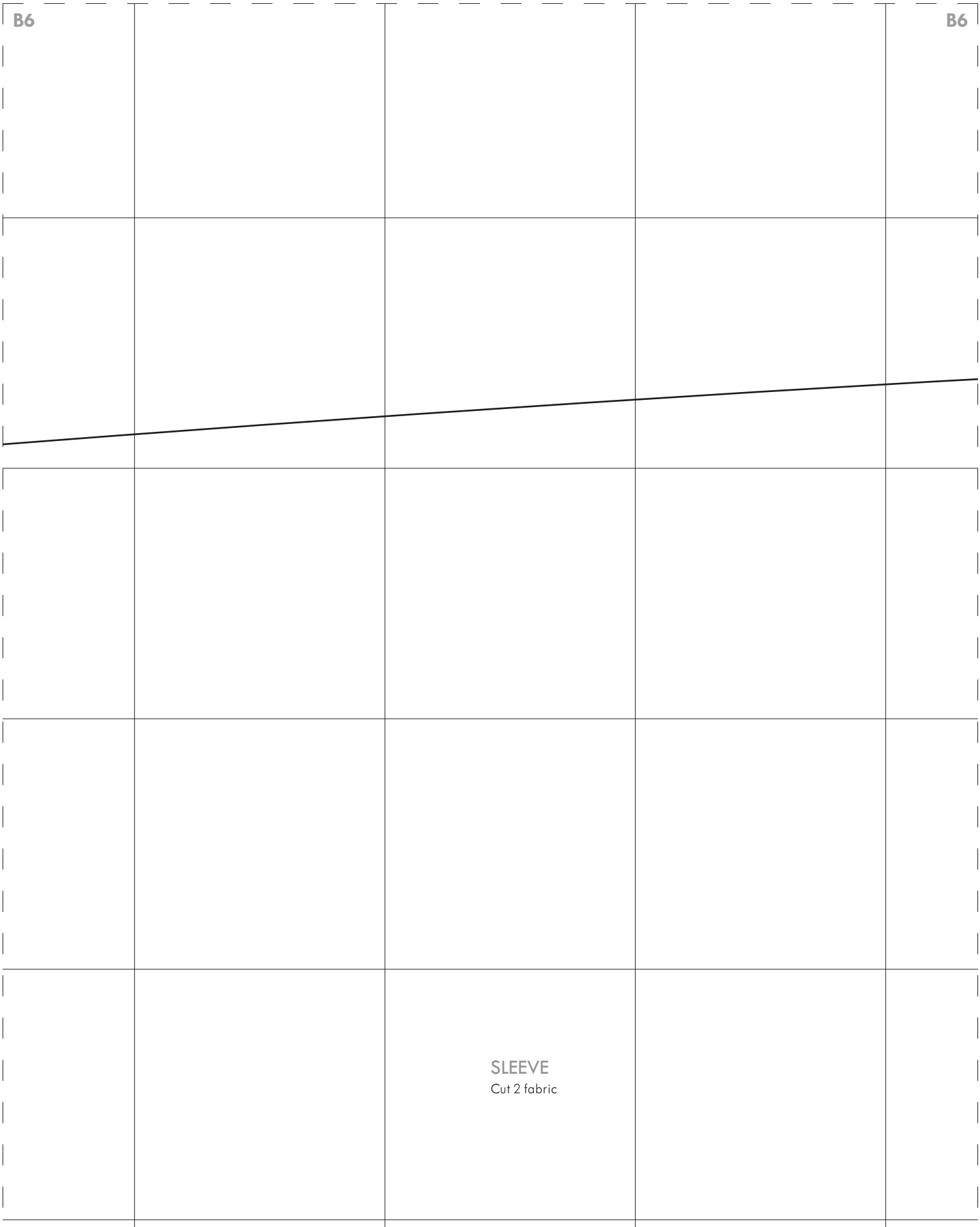

SLEEVE
Cut 2 fabric

B6

B6

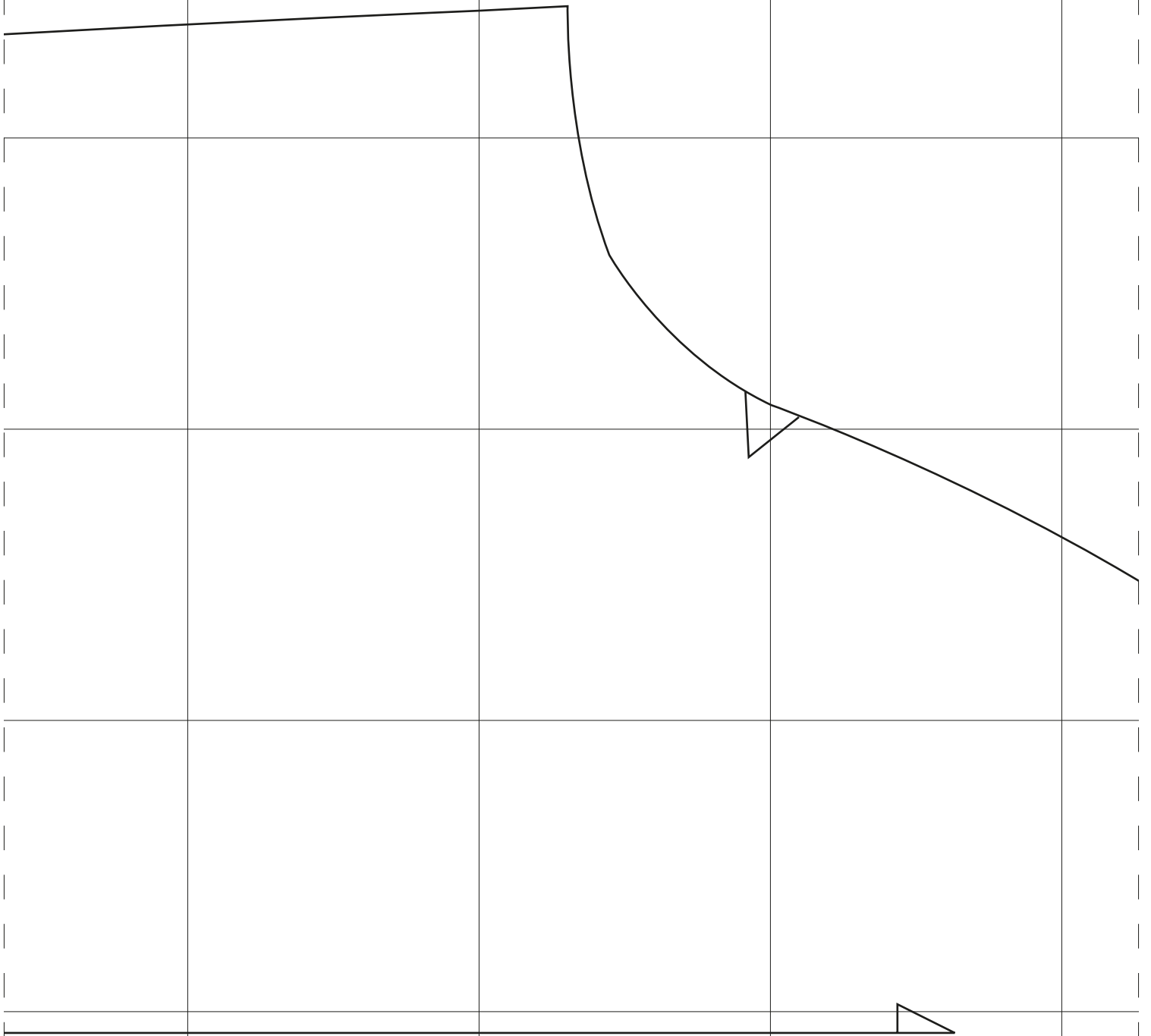

B8

B8

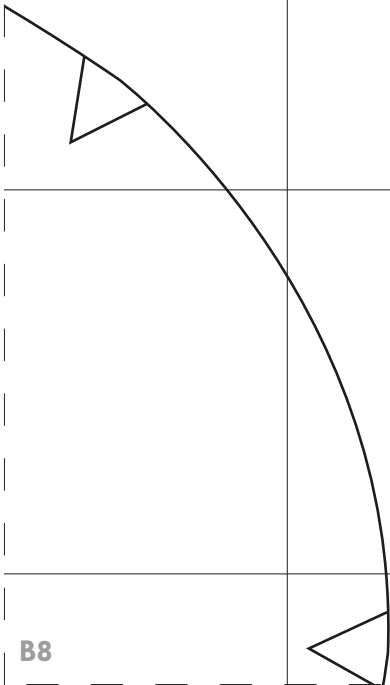

B8

B8

C1

C1

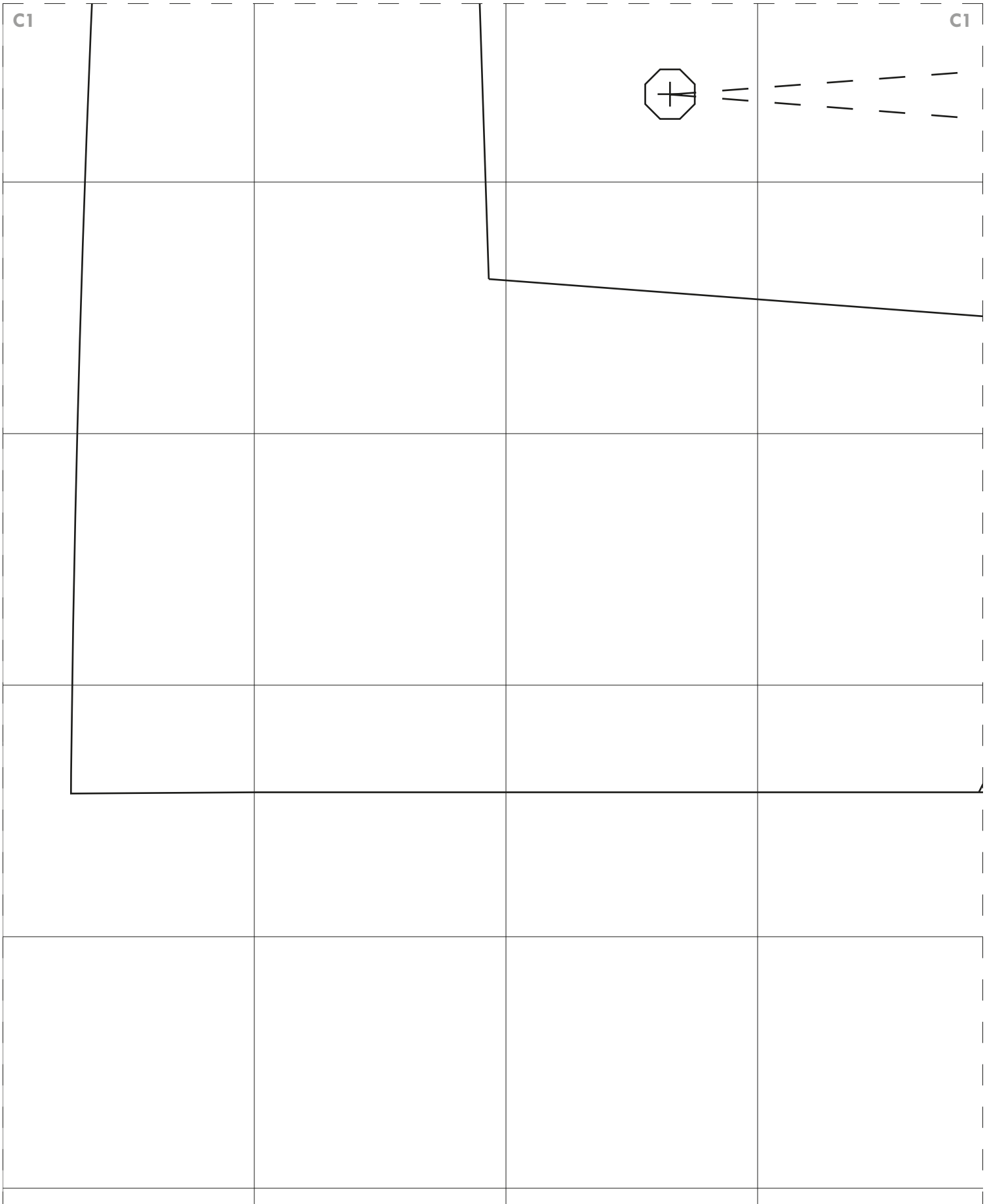
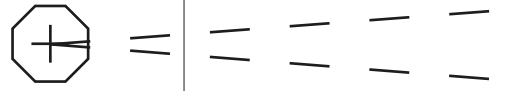

C1

C1

C2

C2

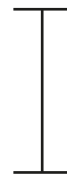
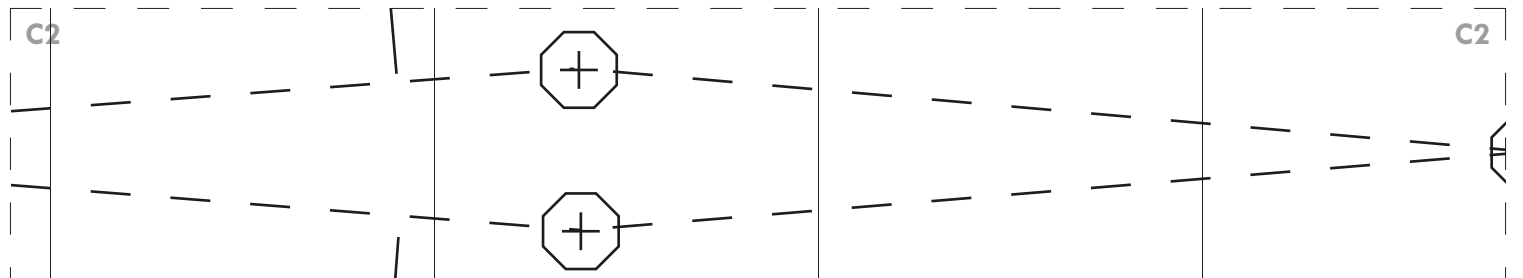

C2

C2

C3

C3

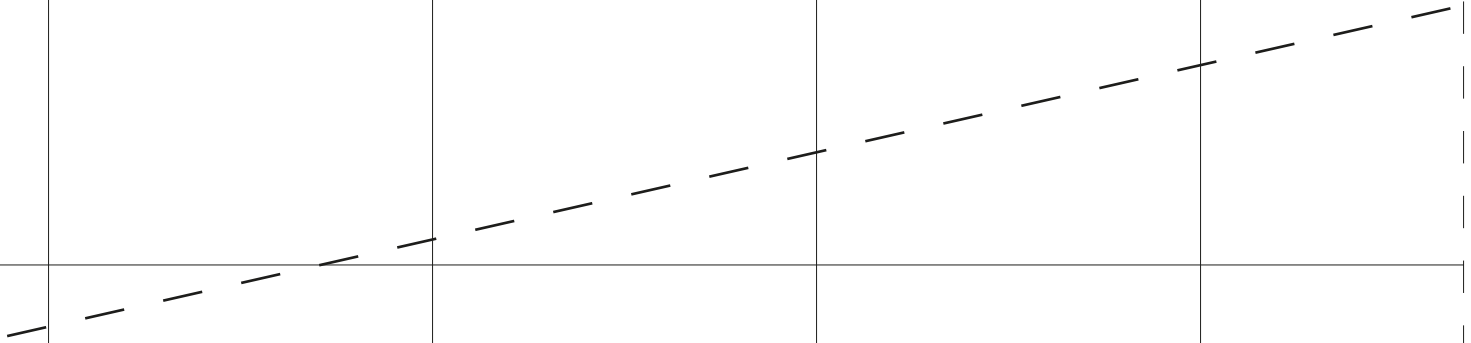

C3

C3

C4

C4

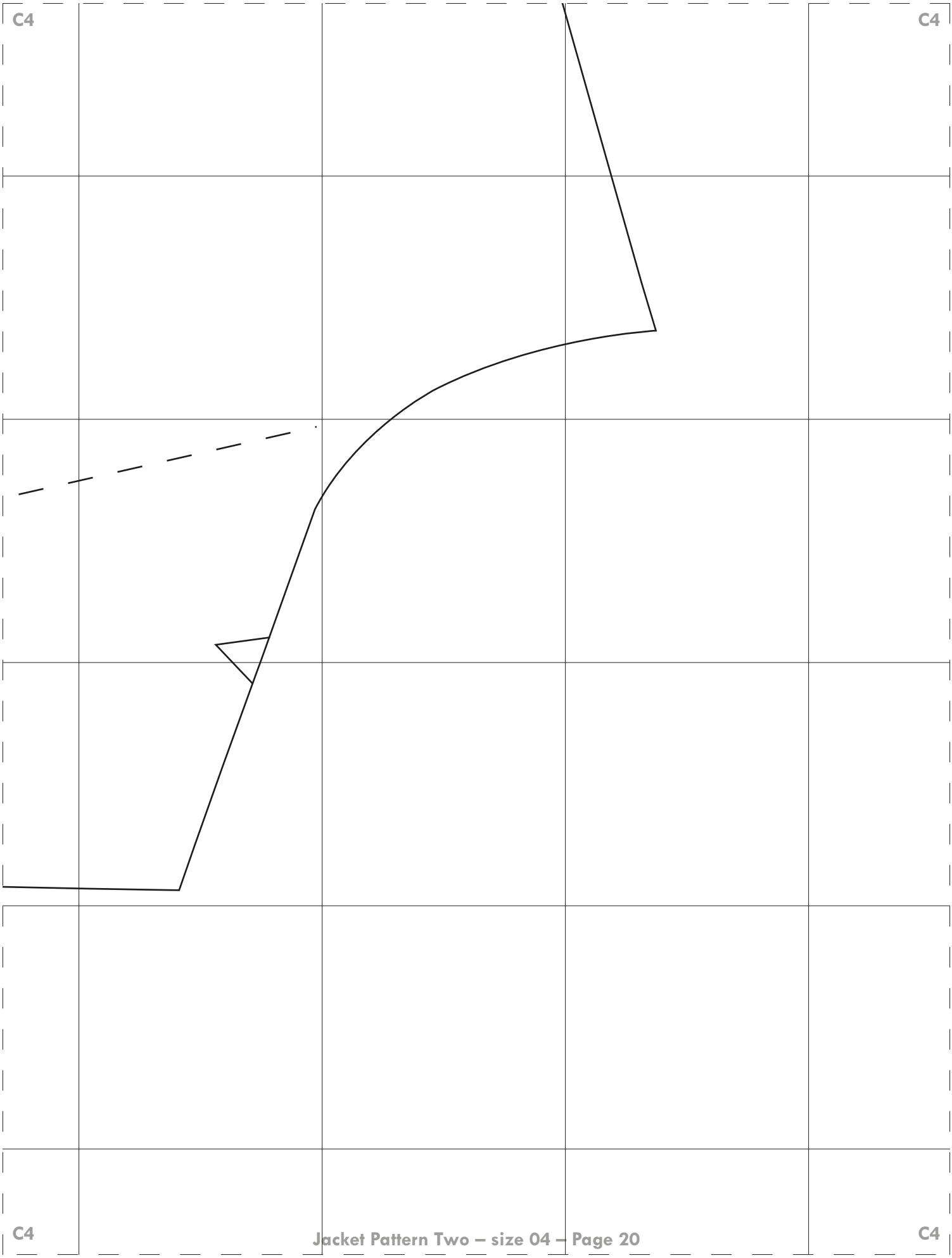

C4

C4

C5

C5



C5

C5

C6

C6

C6

C6

C7

C7

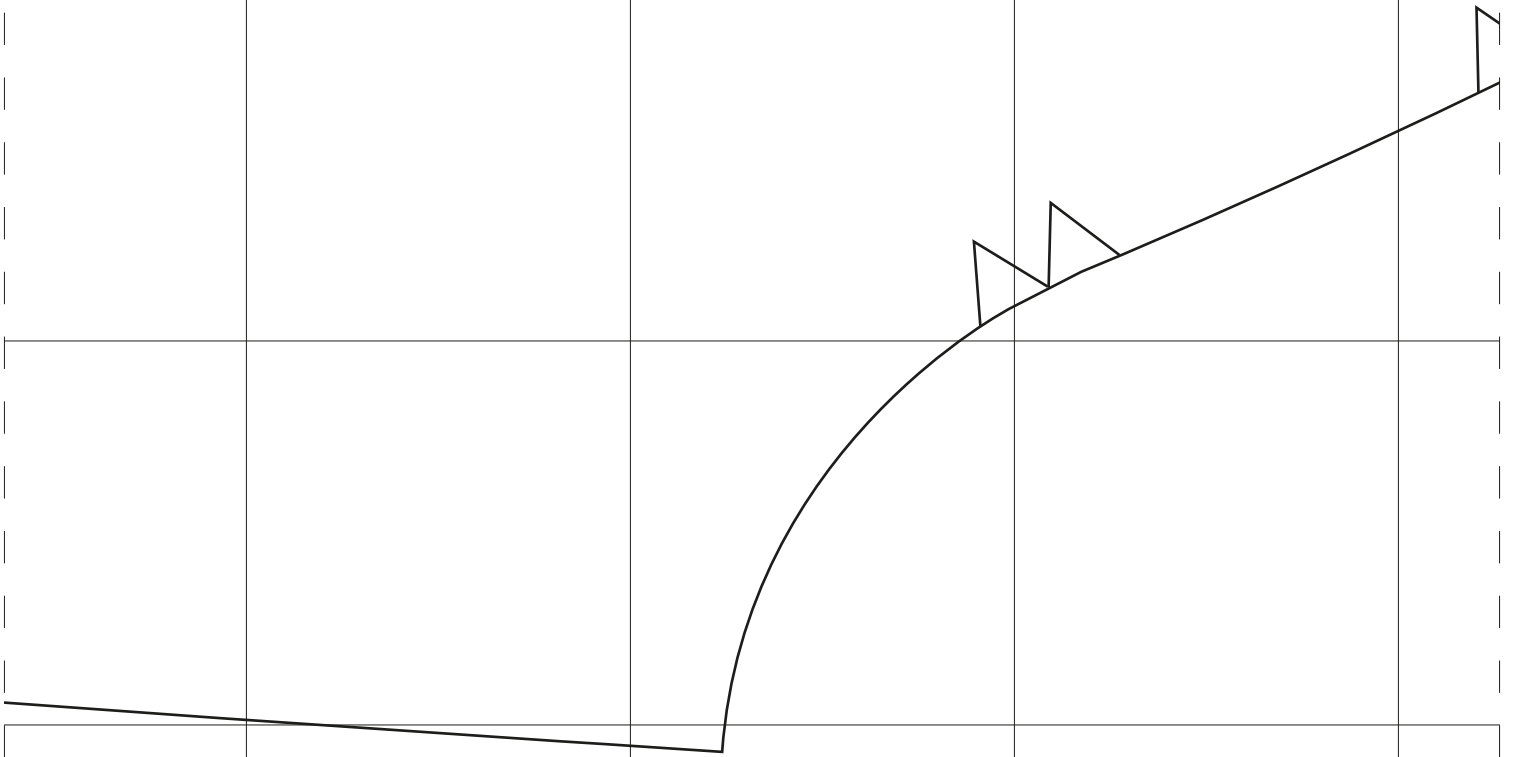

C7

C7

C8

C8

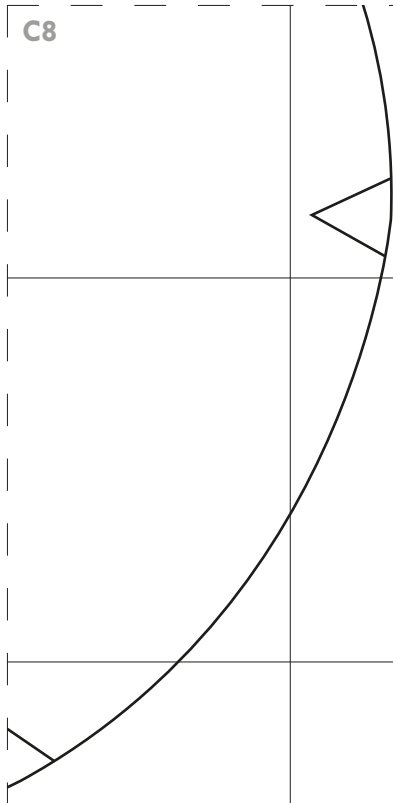

C8

C8

D1

D1

D1

D1



D2

D2

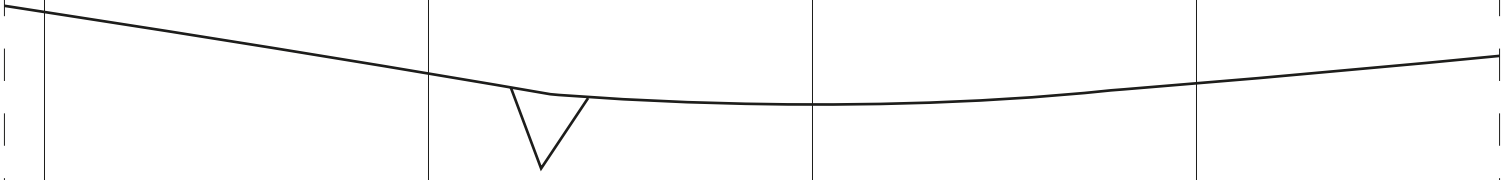

BLAZER BACK
Cut 2 fabric

D2

D2



D3

D3

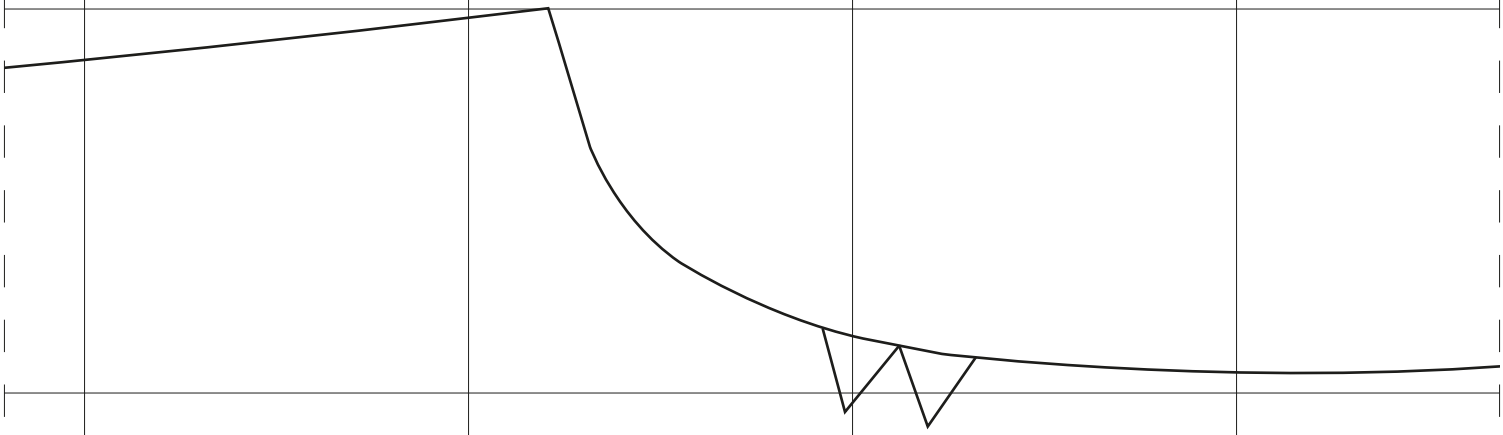

D3

D3

D4

D4

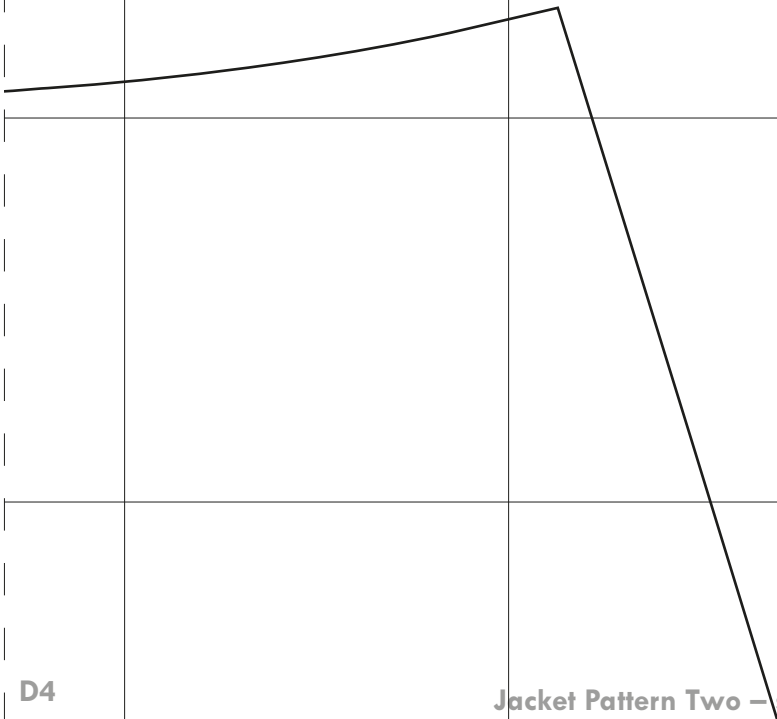

D4

D4

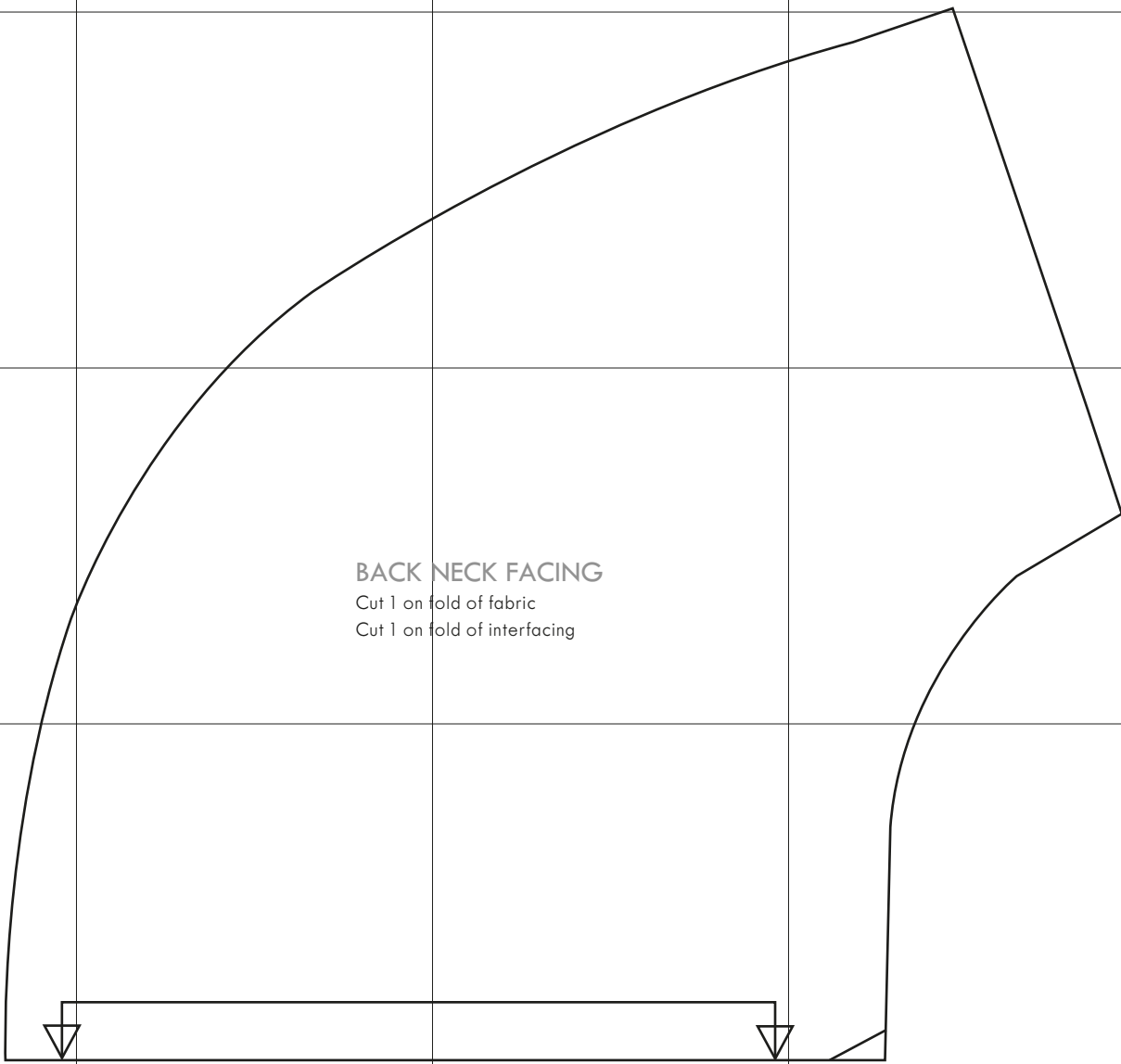

BACK NECK FACING

Cut 1 on fold of fabric
Cut 1 on fold of interfacing

E1

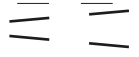

E1

E1

E1

E2

E2



E2

E2

E3



E3

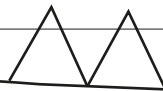

E3

E3

E4

E4

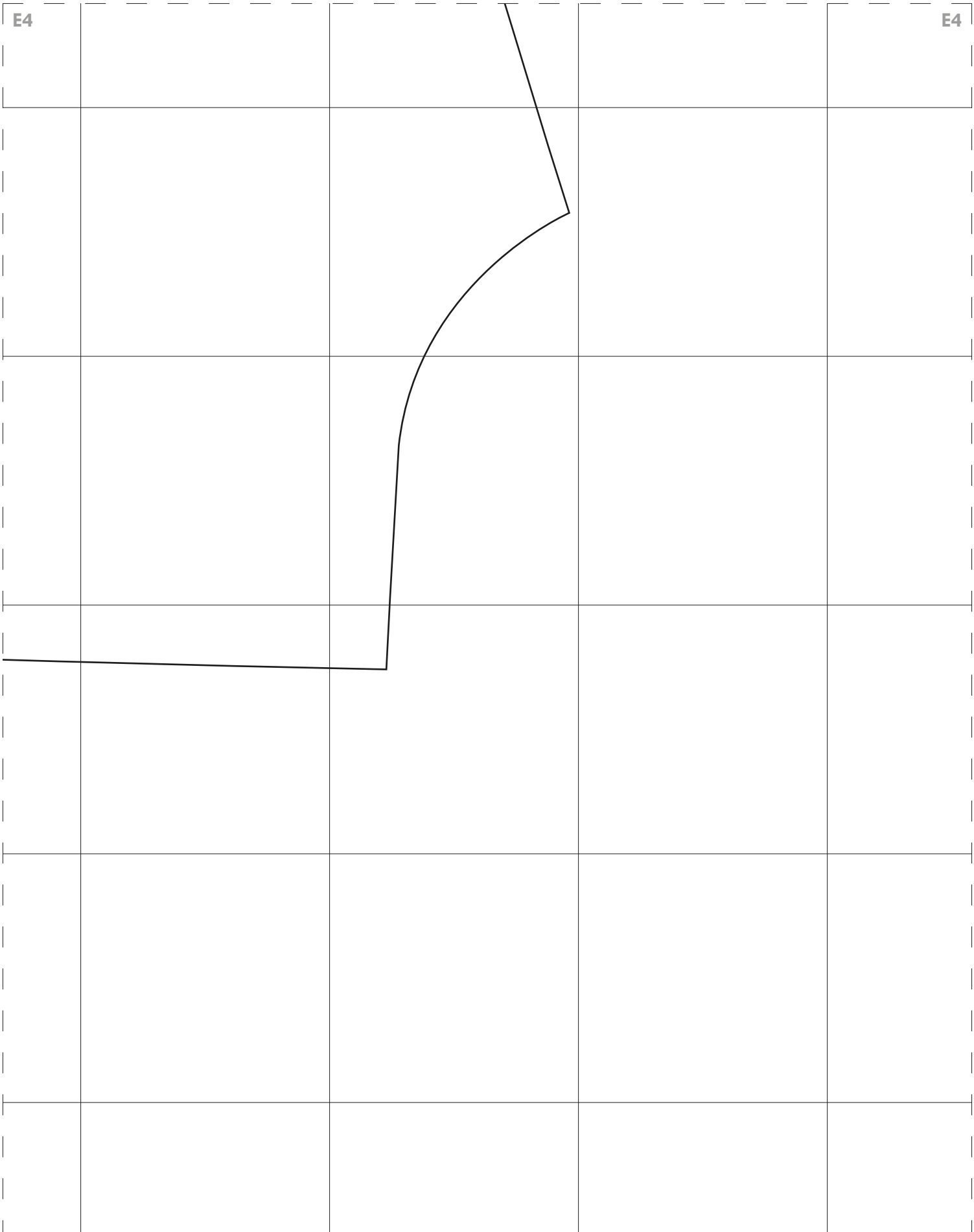

E4

E4

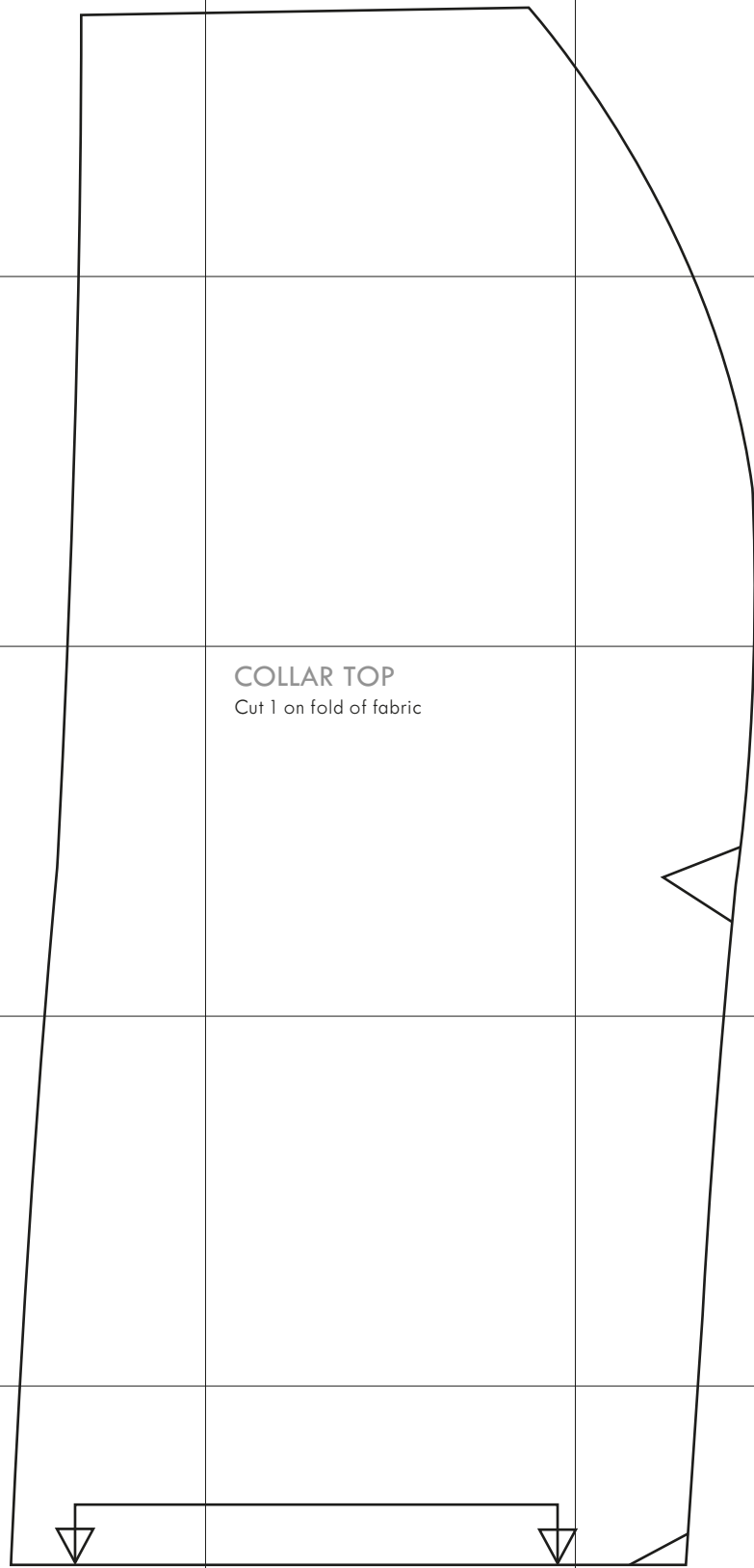

COLLAR TOP
Cut 1 on fold of fabric